

Description

The 551S is a low cost, high-speed single input to four output clock buffer. The 551S has best in class Additive Phase Jitter of sub 50fsec.

IDT makes many non-PLL and PLL based low skew output clock devices as well as Zero Delay Buffers to synchronize clocks. Contact IDT for all of your clocking needs.

Features

- Low additive phase jitter RMS: 50fs
- Extremely low skew outputs (50ps)
- Low cost clock buffer
- Packaged in 8-pin SOIC and 8-pin DFN, Pb-free
- Input/Output clock frequency up to 200MHz
- Non-inverting output clock
- Ideal for networking clocks
- Operating Voltages: 1.8V to 3.3V
- Output Enable mode tri-states outputs
- Advanced, low power CMOS process
- Extended temperature range (-40°C to +105°C)

Block Diagram

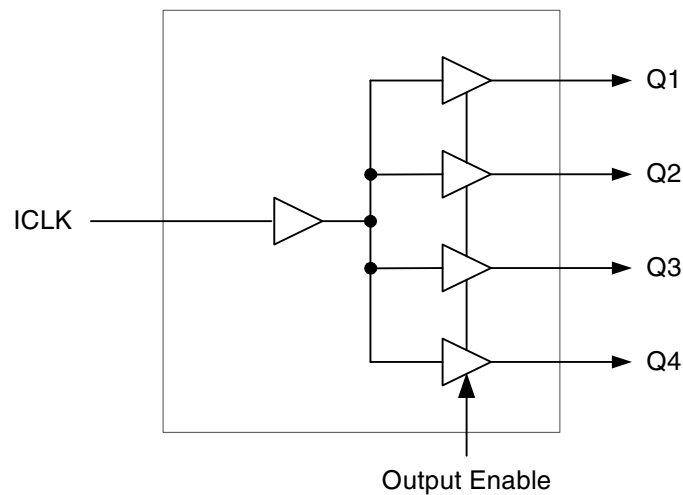

Pin Assignment

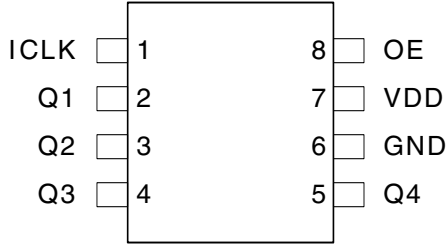

8 Pin (150 mil) SOIC

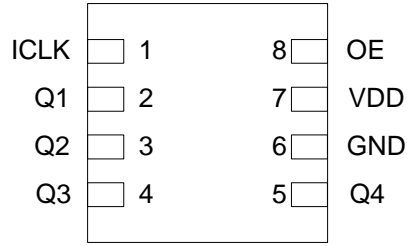

8-pin DFN

Pin Descriptions

Pin Number	Pin Name	Pin Type	Pin Description
1	ICLK	Input	Clock input. Internal pull-up resistor.
2	Q1	Output	Clock output 1.
3	Q2	Output	Clock output 2.
4	Q3	Output	Clock output 3.
5	Q4	Output	Clock output 4.
6	GND	Power	Connect to ground.
7	VDD	Power	Connect +1.8V, +2.5V or +3.3V.
8	OE	Input	Output Enable. Tri-states outputs when low. Internal pull-up resistor.

External Components

A minimum number of external components are required for proper operation. A decoupling capacitor of 0.01 μ F should be connected between VDD on pin 7 and GND on pin 6, as close to the device as possible. A 33 Ω series terminating resistor may be used on each clock output if the trace is longer than 1 inch.

Absolute Maximum Ratings

Stresses above the ratings listed below can cause permanent damage to the 551S. These ratings, which are standard values for IDT commercially rated parts, are stress ratings only. Functional operation of the device at these or any other conditions above those indicated in the operational sections of the specifications is not implied. Exposure to absolute maximum rating conditions for extended periods can affect product reliability. Electrical parameters are guaranteed only over the recommended operating temperature range.

Item	Rating
Supply Voltage, VDD	3.465V
All Inputs and Outputs	-0.5 V to 3.465V
Ambient Operating Temperature, Extended	-40 to +105°C
Storage Temperature	-65 to +150°C
Junction Temperature	125°C
Soldering Temperature	260°C

Recommended Operation Conditions

Parameter	Min.	Typ.	Max.	Units
Ambient Operating Temperature, extended	-40	–	+105	°C
Power Supply Voltage (measured in respect to GND)	+1.71		+3.465	V

DC Electrical Characteristics

VDD=1.8V ±5%, Ambient temperature -40° to +105°C, unless stated otherwise

Parameter	Symbol	Conditions	Min.	Typ.	Max.	Units
Operating Voltage	VDD		1.71		1.89	V
Input High Voltage, ICLK	V _{IH}	Note 1	0.7xVDD		1.89	V
Input Low Voltage, ICLK	V _{IL}	Note 1			0.3xVDD	V
Input High Voltage, OE	V _{IH}		0.7xVDD		VDD	V
Input Low Voltage, OE	V _{IL}				0.3xVDD	V
Output High Voltage	V _{OH}	I _{OH} = -10 mA	1.3			V
Output Low Voltage	V _{OL}	I _{OL} = 10 mA			0.35	V
Operating Supply Current	IDD	No load, 135 MHz		13		mA
Nominal Output Impedance	Z _O			17		Ω
Input Capacitance	C _{IN}	OE pin		5		pF

Notes: 1. Nominal switching threshold is VDD/2.

VDD=2.5V ±5%, Ambient temperature -40° to +105°C, unless stated otherwise

Parameter	Symbol	Conditions	Min.	Typ.	Max.	Units
Operating Voltage	VDD		2.375		2.625	V
Input High Voltage, ICLK	V _{IH}	Note 1	0.7xVDD		2.625	V
Input Low Voltage, ICLK	V _{IL}	Note 1			0.3xVDD	V
Input High Voltage, OE	V _{IH}		0.7xVDD		VDD	V
Input Low Voltage, OE	V _{IL}				0.3xVDD	V
Output High Voltage	V _{OH}	I _{OH} = -16 mA	1.8			V
Output Low Voltage	V _{OL}	I _{OL} = 16 mA			0.5	V
Operating Supply Current	IDD	No load, 135 MHz		18		mA
Nominal Output Impedance	Z _O			17		Ω
Input Capacitance	C _{IN}	OE pin		5		pF

Notes: 1. Nominal switching threshold is VDD/2.

VDD=3.3V ±5%, Ambient temperature -40° to +105°C, unless stated otherwise

Parameter	Symbol	Conditions	Min.	Typ.	Max.	Units
Operating Voltage	VDD		3.135		3.465	V
Input High Voltage, ICLK	V _{IH}	Note 1	0.7xVDD		3.465	V
Input Low Voltage, ICLK	V _{IL}	Note 1			0.3xVDD	V
Input High Voltage, OE	V _{IH}		0.7xVDD		VDD	V
Input Low Voltage, OE	V _{IL}				0.3xVDD	V
Output High Voltage	V _{OH}	I _{OH} = -25 mA	2.2			V
Output Low Voltage	V _{OL}	I _{OL} = 25 mA			0.7	V
Operating Supply Current	IDD	No load, 135 MHz		22		mA
Nominal Output Impedance	Z _O			17		Ω
Input Capacitance	C _{IN}	OE pin		5		pF

Notes: 1. Nominal switching threshold is VDD/2.

AC Electrical Characteristics

VDD=1.8V ±5%, Ambient Temperature -40° to +105°C, unless stated otherwise

Parameter	Symbol	Conditions	Min.	Typ.	Max.	Units
Output Frequency		5pF load, Note 4			200	MHz
Output Clock Rise Time	t _{OR}	0.36 to 1.44 V		0.6	1.0	ns
Output Clock Fall Time	t _{OF}	1.44 to 0.36V		0.6	1.0	ns
Propagation Delay		135 MHz, Note 1	1.5	2	4	ns
Buffer Additive Phase Jitter, RMS		125MHz, Integration range: 12kHz–20MHz		0.03	0.05	ps
Output to Output Skew		Rising edges at VDD/2, Note 2		50	65	ps
Start-up Time	t _{START-UP}	Part start-up time for valid outputs after VDD ramp-up			2	ms
Output Enable Time	t _{EN}	CL ≤ 5pF			3	cycles
Output Disable Time	t _{DIS}	CL ≤ 5pF			3	cycles

VDD=2.5V ±5%, Ambient Temperature -40° to +105°C, unless stated otherwise

Parameter	Symbol	Conditions	Min.	Typ.	Max.	Units
Output Frequency		5pF load, Note 4			200	MHz
Output Clock Rise Time	t _{OR}	0.5 to 2.0V		0.6	1.0	ns
Output Clock Fall Time	t _{OF}	2.0 to 0.5V		0.6	1.0	ns
Propagation Delay		135 MHz, Note 1	1.8	2.5	4.5	ns
Buffer Additive Phase Jitter, RMS		125MHz, Integration range: 12kHz–20MHz		0.035	0.05	ps
Output to Output Skew		Rising edges at VDD/2, Note 2		50	65	ps
Start-up Time	t _{START-UP}	Part start-up time for valid outputs after VDD ramp-up			2	ms
Output Enable Time	t _{EN}	CL ≤ 5pF			3	cycles
Output Disable Time	t _{DIS}	CL ≤ 5pF			3	cycles

VDD=3.3V ±5%, Ambient Temperature -40° to +105°C, unless stated otherwise

Parameter	Symbol	Conditions	Min.	Typ.	Max.	Units
Output Frequency		5pF load, Note 4			200	MHz
Output Clock Rise Time	t _{OR}	0.66 to 2.64V		0.6	1.0	ns
Output Clock Fall Time	t _{OF}	2.64 to 0.66V		0.6	1.0	ns
Propagation Delay		135 MHz, Note 1	1.5	2	4	ns
Buffer Additive Phase Jitter, RMS		125MHz, Integration range: 12kHz–20MHz		0.037	0.05	ps
Output to Output Skew		Rising edges at VDD/2, Note 2		50	65	ps
Start-up Time	t _{START-UP}	Part start-up time for valid outputs after VDD ramp-up			2	ms
Output Enable Time	t _{EN}	CL ≤ 5pF			3	cycles
Output Disable Time	t _{DIS}	CL ≤ 5pF			3	cycles

Notes:

1. With rail to rail input clock.
2. Between any 2 outputs with equal loading.
3. Duty cycle on outputs will match incoming clock duty cycle. Consult IDT for tight duty cycle clock generators.
4. With external series resistor of 33Ω positioned close to each output pin.

Phase Noise Plots

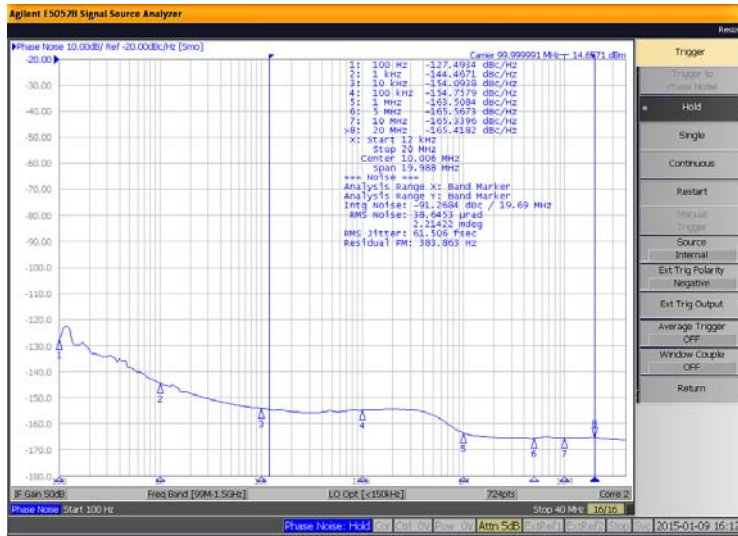

Figure 1. 551S Reference Phase Noise 62fs (12kHz to 20MHz)

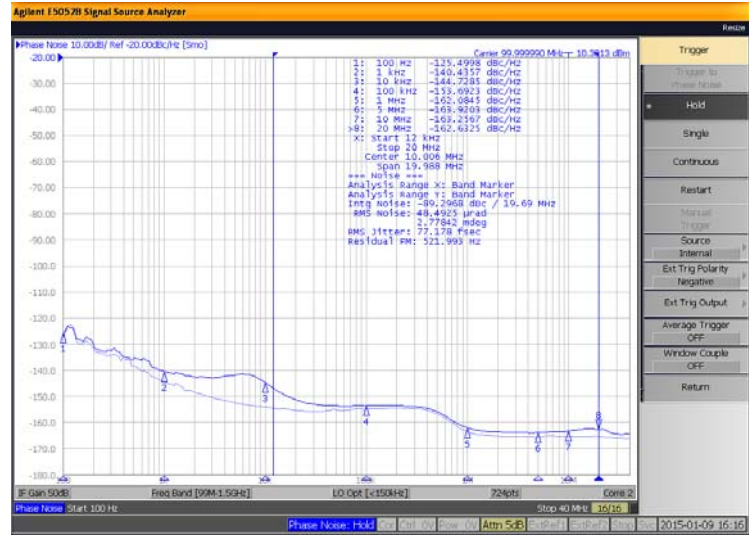
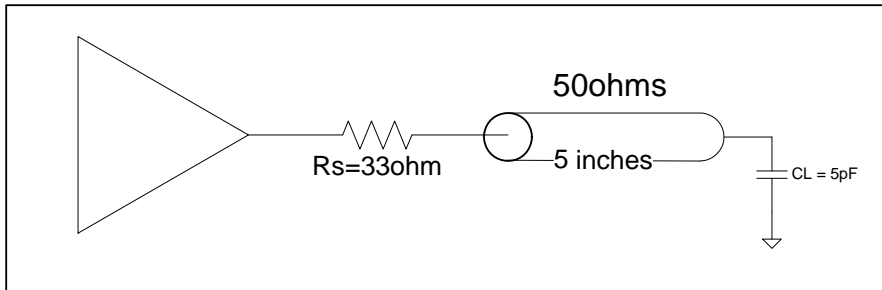

Figure 2. 551S Output Phase Noise 77fs (12kHz to 20MHz)

The phase noise plots above show the low Additive Jitter of the 551S high-performance buffer. With an integration range of 12kHz to 20MHz, the reference input has about 62fs of RMS phase jitter while the output of 551S has about 77fs of RMS phase jitter. This results in a low Additive Phase Jitter of only 45fs.

Test Load and Circuit



Thermal Characteristics (8SOIC)

Parameter	Symbol	Conditions	Min.	Typ.	Max.	Units
Thermal Resistance Junction to Ambient	θ_{JA}	Still air		150		°C/W
	θ_{JA}	1 m/s air flow		140		°C/W
	θ_{JA}	3 m/s air flow		120		°C/W
Thermal Resistance Junction to Board	θ_{JB}			89		°C/W
Thermal Resistance Junction to Case	θ_{JC}			40		°C/W

Marking Diagrams

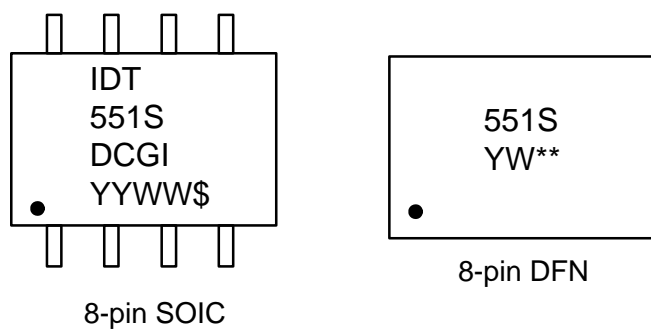

Notes:

1. “**” is the lot number.
2. “YYWW” or “YW” are the last digits of the year and week that the part was assembled.
- 3 “G” denotes RoHS compliant package.
4. “\$” denotes the mark code.
5. “I” denotes extended temperature range device.

Package Outline Drawings

The package outline drawings are appended at the end of this document and are accessible from the link below. The package information is the most current data available.

www.idt.com/document/psc/dcg8-package-outline-drawing-0150-body-width-0050-pitch-soic

www.idt.com/document/psc/cm88-package-outline-drawing-20-x-20-x-05-mm-body-05mm-pitch-dfn

Ordering Information

Part / Order Number	Marking	Shipping Packaging	Package	Temperature
551SDCGI	see page 7	Tubes	8-pin SOIC	-40 to +105 °C
551SDCGI8		Tape and Reel	8-pin SOIC	-40 to +105 °C
551SCMGI		Cut Tape	8-pin DFN	-40 to +105 °C
551SCMGI8		Tape and Reel	8-pin DFN	-40 to +105 °C

“G” suffix to the part number denotes Pb-Free configuration, RoHS compliant.

Revision History

Date	Description of Change
September 20, 2018	<ul style="list-style-type: none"> Added Thermal Resistance Junction to Board to Thermal Characteristics table. Updated Package Outline Drawings section.
March 18, 2015	Initial release.

IMPORTANT NOTICE AND DISCLAIMER

RENESAS ELECTRONICS CORPORATION AND ITS SUBSIDIARIES (“RENESAS”) PROVIDES TECHNICAL SPECIFICATIONS AND RELIABILITY DATA (INCLUDING DATASHEETS), DESIGN RESOURCES (INCLUDING REFERENCE DESIGNS), APPLICATION OR OTHER DESIGN ADVICE, WEB TOOLS, SAFETY INFORMATION, AND OTHER RESOURCES “AS IS” AND WITH ALL FAULTS, AND DISCLAIMS ALL WARRANTIES, EXPRESS OR IMPLIED, INCLUDING, WITHOUT LIMITATION, ANY IMPLIED WARRANTIES OF MERCHANTABILITY, FITNESS FOR A PARTICULAR PURPOSE, OR NON-INFRINGEMENT OF THIRD PARTY INTELLECTUAL PROPERTY RIGHTS.

These resources are intended for developers skilled in the art designing with Renesas products. You are solely responsible for (1) selecting the appropriate products for your application, (2) designing, validating, and testing your application, and (3) ensuring your application meets applicable standards, and any other safety, security, or other requirements. These resources are subject to change without notice. Renesas grants you permission to use these resources only for development of an application that uses Renesas products. Other reproduction or use of these resources is strictly prohibited. No license is granted to any other Renesas intellectual property or to any third party intellectual property. Renesas disclaims responsibility for, and you will fully indemnify Renesas and its representatives against, any claims, damages, costs, losses, or liabilities arising out of your use of these resources. Renesas' products are provided only subject to Renesas' Terms and Conditions of Sale or other applicable terms agreed to in writing. No use of any Renesas resources expands or otherwise alters any applicable warranties or warranty disclaimers for these products.

(Rev.1.0 Mar 2020)

Corporate Headquarters

TOYOSU FORESIA, 3-2-24 Toyosu,
Koto-ku, Tokyo 135-0061, Japan
www.renesas.com

Contact Information

For further information on a product, technology, the most up-to-date version of a document, or your nearest sales office, please visit:
www.renesas.com/contact/

Trademarks

Renesas and the Renesas logo are trademarks of Renesas Electronics Corporation. All trademarks and registered trademarks are the property of their respective owners.