

**SURFACE MOUNT SCHOTTKY BARRIER RECTIFIER**

**VOLTAGE RANGE 20 to 60 Volts CURRENT 1.0 Ampere**

**FEATURES**

- \* Ideal for surface mounted applications
- \* Low leakage current
- \* Metallurgically bonded construction
- \* Mounting position: Any
- \* Weight: 0.015 gram

**MECHANICAL DATA**

- \* Epoxy : Device has UL flammability classification 94V-0

**DISCONTINUED-**

"This series is replaced by the FM1XX series that meets to the same fit and function parameters and share the same solder pad layout. The FM1XX series is preferred for error-free vacuum pick-up and PCB assembly."

Discontinued

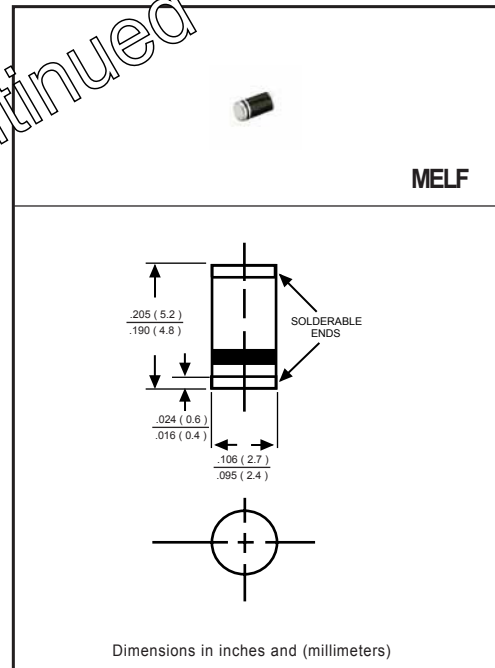

**MAXIMUM RATINGS AND ELECTRICAL CHARACTERISTICS**

Ratings at 25 °C ambient temperature unless otherwise specified.  
Single phase, half wave, 60 Hz, resistive or inductive load.  
For capacitive load, derate current by 20%.

**MAXIMUM RATINGS (@ TA=25 °C unless otherwise noted)**

RATINGS	SYMBOL	SM120	SM130	SM140	SM150	SM160	UNITS
Maximum Recurrent Peak Reverse Voltage	V <sub>RRM</sub>	20	30	40	50	60	Volts
Maximum RMS Voltage	V <sub>RMS</sub>	14	21	28	35	42	Volts
Maximum DC Blocking Voltage	V <sub>DC</sub>	20	30	40	50	60	Volts
Maximum Average Forward Rectified Current at Derating Case Temperature	I <sub>O</sub>	1.0					Amps
Peak Forward Surge Current 8.3 ms single half sine-wave superimposed on rated load (JEDEC method)	I <sub>FSM</sub>	40					Amps
Typical Junction Capacitance (Note 2)	C <sub>J</sub>	110					pF
Operating Temperature Range	T <sub>J</sub>	150					°C
Storage Temperature Range	T <sub>STG</sub>	-55 to + 150					°C

**ELECTRICAL CHARACTERISTICS (@TA=25 °C unless otherwise noted)**

CHARACTERISTICS	SYMBOL	SM120	SM130	SM140	SM150	SM160	UNITS
Maximum Instantaneous Forward Voltage at 1.0A DC	V <sub>F</sub>	.55			.70		Volts
Maximum Average Reverse Current	I <sub>R</sub>	@T <sub>A</sub> = 25°C					mA
at Rated DC Blocking Voltage		@T <sub>A</sub> = 100°C					mA

NOTES : 1. Measured at 1 MHz and applied reverse voltage of 4.0 volts.  
2. "Fully ROHS compliant", "100% Sn plating (Pb-free)".

2007-5

# RATING AND CHARACTERISTICS CURVES ( SM120 THRU SM160 )

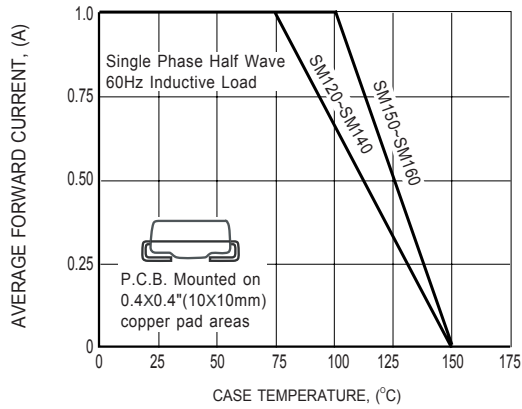

FIG.1 TYPICAL FORWARD CURRENT DERATING CURVE

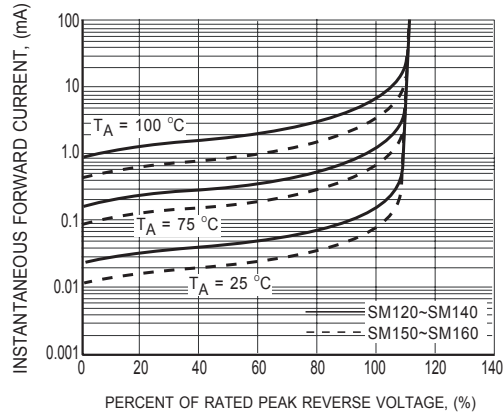

FIG.2 TYPICAL REVERSE CHARACTERISTICS

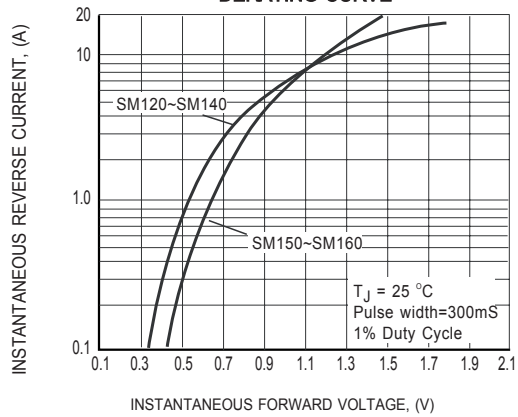

FIG.3 TYPICAL INSTANTANEOUS FORWARD CHARACTERISTICS

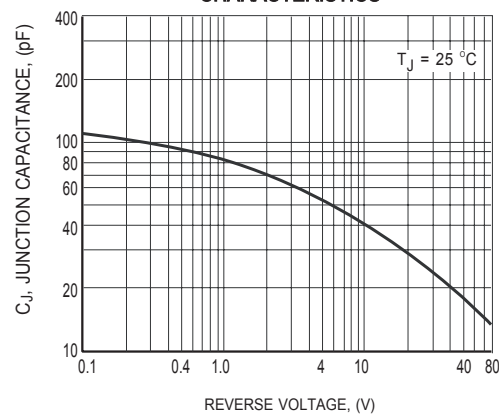

FIG.4 TYPICAL JUNCTION CAPACITANCE

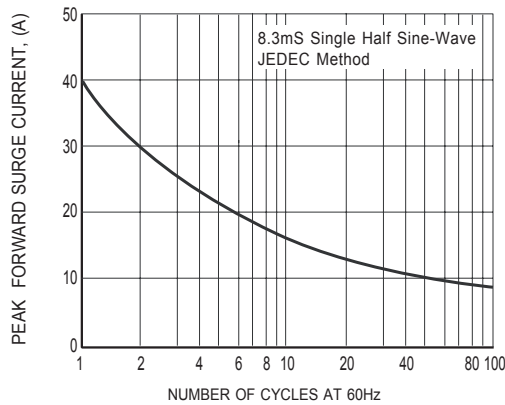
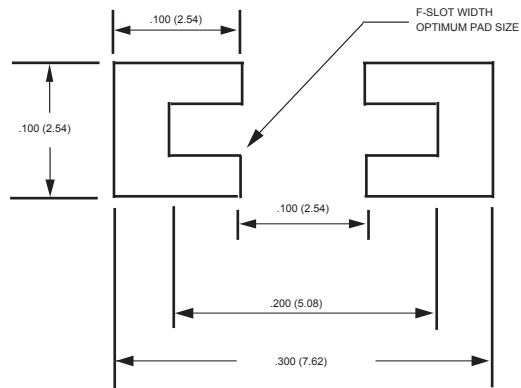

FIG.5 MAXIMUM NON-REPETITIVE FORWARD SURGE CURRENT



## Mounting Pad Layout



Dimensions in inches and (millimeters)

## DISCLAIMER NOTICE

Rectron Inc reserves the right to make changes without notice to any product specification herein, to make corrections, modifications, enhancements or other changes. Rectron Inc or anyone on its behalf assumes no responsibility or liability for any errors or inaccuracies. Data sheet specifications and its information contained are intended to provide a product description only. "Typical" parameters which may be included on RECTRON data sheets and/ or specifications can and do vary in different applications and actual performance may vary over time. Rectron Inc does not assume any liability arising out of the application or use of any product or circuit.

Rectron products are not designed, intended or authorized for use in medical, life-saving implant or other applications intended for life-sustaining or other related applications where a failure or malfunction of component or circuitry may directly or indirectly cause injury or threaten a life without expressed written approval of Rectron Inc. Customers using or selling Rectron components for use in such applications do so at their own risk and shall agree to fully indemnify Rectron Inc and its subsidiaries harmless against all claims, damages and expenditures.

