

# Features

# Evaluation Module

- Evaluation platform for RPMH-0.5 Power Modules
- Thermal design considerations included
- EMI Class B filter
- Easy evaluation of control, power good and sensing functions

**RECOM**  
Evaluation Module

**RPMH-0.5-EVM-1**

## Description

The RPMH-0.5-EVM-1 generates a constant output voltage with an output current up to 0.5A from an external DC source. All the functions of the RPMH-0.5 such as trimming, sequencing, control, and sensing can be evaluated. Also the behavior in overload or over temperature can be evaluated easily before design-in.

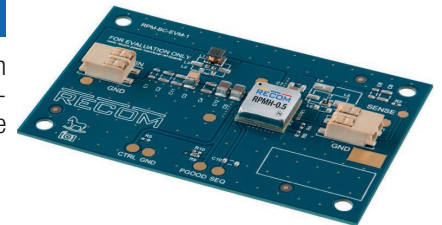

## Selection Guide

Part Number	Input Voltage Range [VDC]	Output Voltage nom. [VDC]	Vout Adjust Range [VDC]	Output Current max. [A]
RPMH3.3-0.5-EVM-1	4.3-65	3.3	2.64-3.63	0.5
RPMH5.0-0.5-EVM-1	6-65	5	4-5.5	0.5
RPMH12-0.5-EVM-1	13.5-65	12	7.2-13.2	0.5
RPMH15-0.5-EVM-1	16.5-65	15	9-16.5	0.5
RPMH24-0.5-EVM-1	25.5-65	24	15-28	0.5

## Quick Start Guide

- 1) Connect P1 to power supply (observe correct polarity!)
- 2) Connect P2 to a Load
- 3) Connect sense to the required potential  
The sense preset is via R1 directly at the power module, so the preset voltage is very accurate at the output of the RPMH-0.5. To equalize ohmic losses of the output filter, remove the resistor at R1, and solder a 0Ω resistor at R2.
- 4) Disable the device via R5  
The device is preset as normally on. It can be disabled by pulling the CTRL pad to GND. Short R5 to disable the device.

Specifications (measured @ Ta= 25°C, full load after warm up unless otherwise stated)

### Component Placement

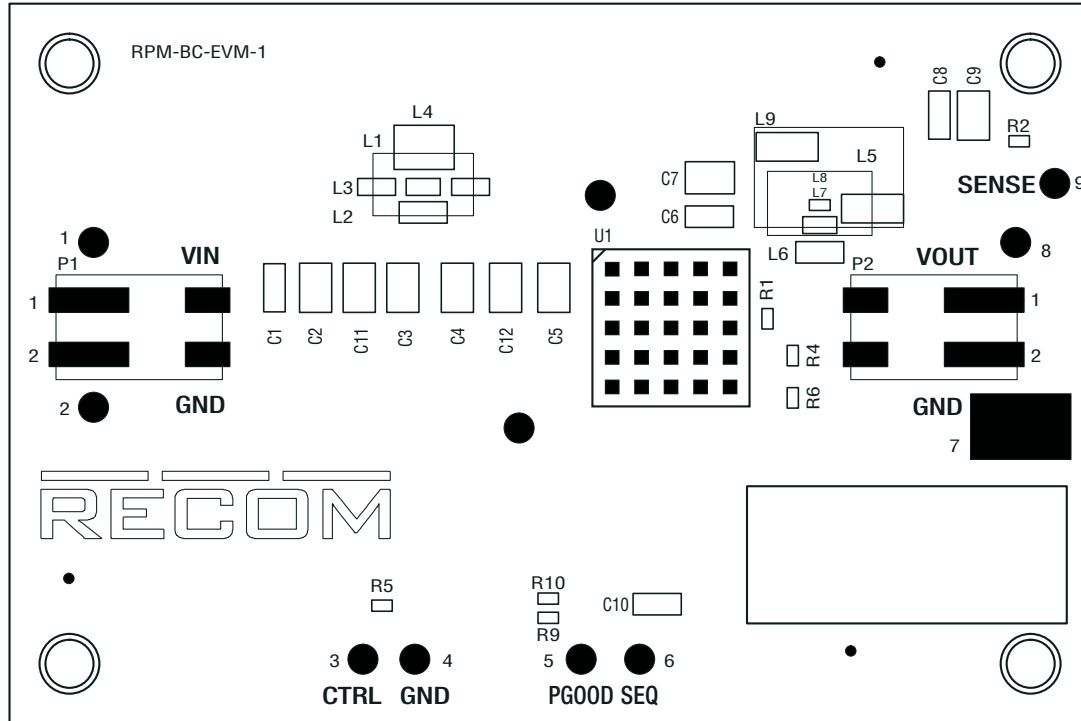

### Connector Description

#### P1

Pin	Name	Description
1	$V_{in}$	Positive Input Voltage (observe correct polarity!)
2	GND	Common GND

#### P2

Pin	Name	Description
1	$V_{out}$	Positive Output Voltage
2	GND	Common GND

#### PADS direct connection

Pin	Name	Description
1	$V_{in}$	Connect to $V_{in}$
2	GND	Common GND
3	CTRL	CTRL Pin (leave open if not used)
4	GND	Common GND
5	PGOOD	Power good signal
6	SEQ	Sequencing and soft start
7	GND	Common GND, can connect oscilloscope GND for measurement
8	$V_{out}$	Positive Output Voltage
9	SENSE	Output Voltage Sense Pin (leave open if not used)

Specifications (measured @ Ta= 25°C, full load after warm up unless otherwise stated)

## Schematic

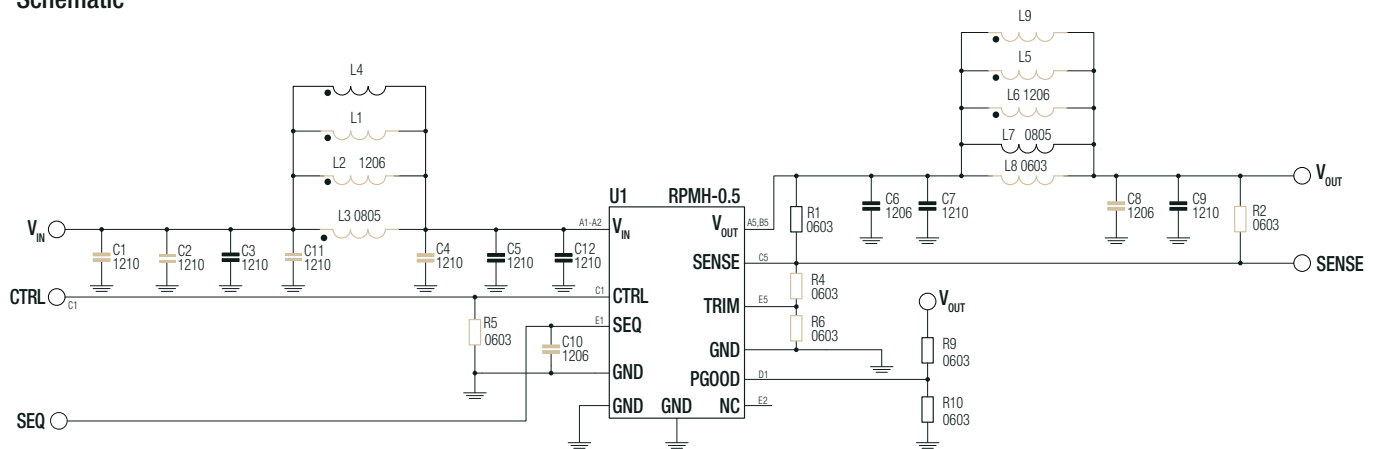

### Notes:

Note1: Grey colored components are not mounted

## Description

U1: RPMH-0.5 power module.

C1,C2,C3,C11,L1,L2,L3,L4,C4,C5,C12: allow placement of various sized components to test input filter design. The populated filter is designed to meet EN55032 class B

C6,C7,L5,L6,L7, L8, L9,C8,C9: allow placement of various sized components to test output filter design. The populated filter is designed to meet EN55032 class B

R5: connect 0Ω resistor to disable the module. This resistor is not populated.

C10: sets soft-start time. Refer to RPMH-0.5 datasheet for more information.

R9: populated 100kΩ resistor which is pulled up to VOUT. This is for output power good signal.

R10: this resistor is only populated for RPMH12-0.5-EVM-1, RPMH15-0.5-EVM-1, and RPMH24-0.5-EVM-1. This limits the voltage of PGOOD signal to half the output voltage. Refer to RPMH-0.5 datasheet for more information.

R1: populated 0Ω resistor for direct output voltage measurement. If sense is desired at a different location, for example after the filter or directly at the load), desolder R1, and connect sense to the new measurement point.

R2: sense point for output voltage after the filter. To set sense point here, remove R1 and solder a 0Ω resistor at R2.

R4 and R6: trim the output voltage. Refer to „**OUTPUT VOLTAGE TRIMMING**“

## OUTPUT VOLTAGE TRIMMING

The RPMH-series offers the feature of trimming the output voltage over a range between -20% to +10% for lower output voltages and from -40% to +10% for higher output voltages. This can be done by using external trim resistors. The values for the trim resistors in trim tables are according to standard E96 values; therefore, the specified voltage may slightly vary.

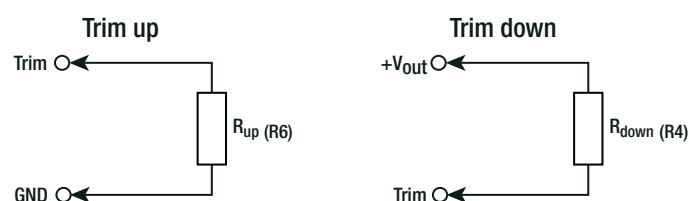

continued on next page

**Specifications** (measured @ Ta= 25°C, full load after warm up unless otherwise stated)

**Calculation:**

- $V_{out\_nom}$  = nominal output voltage [VDC]
- $V_{out\_set}$  = trimmed output voltage [VDC]
- $V_{ref}$  = reference voltage [VDC]
- $R_{up}$  = trim up resistor [kΩ]
- $R_{down}$  = trim down resistor [kΩ]
- $R_{Hi}, R_{Lo}$  = internal resistors [kΩ]

$V_{out\_nom}$	$R_{Hi}$	$R_{Lo}$	$V_{ref}$
3.3VDC	205kΩ	169kΩ	1.223k
5VDC	374kΩ	309kΩ	
12VDC	1.22MΩ	1MΩ	
15VDC	1.22MΩ	1MΩ	
24VDC	1.22MΩ	1MΩ	

$$R_{up} = \left[ \frac{R_{Hi}}{V_{out\_set} - V_{nom}} \right] - 1k$$

$$R_{down} = \left[ \frac{(V_{out\_set} - V_{ref}) \times R_{Lo}}{V_{out\_nom} - V_{set}} \right]$$

**Practical Example RPMH3.3-0.5, trim up**

$V_{out\_set} = 3.63VDC$

$$R_{up} = \left[ \frac{205k}{3.63 - 3.3} \right] - 1k = \underline{\underline{621k\Omega}}$$

$R_{up}$  according to E96  $\approx$  619kΩ

**Practical Example RPMH3.3-0.5, trim down**

$V_{out\_set} = 2.64VDC$

$$R_{down} = \left[ \frac{(2.64 - 1.223) \times 169k}{3.3 - 2.64} \right] = \underline{\underline{363k\Omega}}$$

$R_{down}$  according to E96  $\approx$  365kΩ

**RPMH3.3-0.5**

**Trim up**

$V_{out\_set} =$	3.4V	3.5V	3.63V	[VDC]
$R_{up}$ (E96) $\approx$	2M05	1M02	619k	[Ω]

**Trim down**

$V_{out\_set} =$	3.1V	3V	2.8V	2.64V	[VDC]
$R_{down}$ (E96) $\approx$	1M58	1M	536k	365k	[Ω]

**RPMH5.0-0.5**

**Trim up**

$V_{out\_set} =$	5.1V	5.3V	5.5V	[VDC]
$R_{up}$ (E96) $\approx$	3M74	1M24	750k	[Ω]

**Trim down**

$V_{out\_set} =$	4.7V	4.5V	4.3V	4V	[VDC]
$R_{down}$ (E96) $\approx$	3M57	2M	1M33	845k	[Ω]

**RPMH12-0.5**

**Trim up**

$V_{out\_set} =$	12.4	12.6	12.8	13	13.2	[VDC]
$R_{up}$ (E96) $\approx$	3M01	2M	1M5	1M2	1M	[Ω]

**Trim down**

$V_{out\_set} =$	10	9.6	9	8.5	8	7.7	7.2	[VDC]
$R_{down}$ (E96) $\approx$	4M32	3M4	2M61	2M05	1M69	1M5	1M24	[Ω]

continued on next page

**Specifications** (measured @ Ta= 25°C, full load after warm up unless otherwise stated)

**RPMH15-0.5**

**Trim up**

V <sub>outset</sub> =	15.5	15.7	15.9	16.1	16.3	16.5	[VDC]
R <sub>up</sub> (E96) ≈	2M4	1M74	1M33	1M1	931k	820k	[Ω]

**Trim down**

V <sub>outset</sub> =	12	11.5	11	10.5	10	9.5	9	[VDC]
R <sub>down</sub> (E96) ≈	3M6	2M94	2M4	2M05	1M74	1M5	1M3	[Ω]

**RPMH24-0.5**

**Trim up**

V <sub>outset</sub> =	24.5	25	25.5	26	26.4	27	28	[VDC]
R <sub>up</sub> (E96) ≈	2M43	1M2	806k	604k	511k	402k	300k	[Ω]

**Trim down**

V <sub>outset</sub> =	19.5	19.2	18	17.5	17	16.5	16	15.5	15	[VDC]
R <sub>down</sub> (E96) ≈	3M9	3M74	2M8	2M49	2M26	2M	1M82	1M69	1M5	[Ω]

**DIMENSION AND PHYSICAL CHARACTERISTICS**

Parameter	Type	Value
Dimension (LxWxH)		85.0 x 55.0 x 5.9mm
Weight		20.5g. typ.

**Layout**

Top Layer

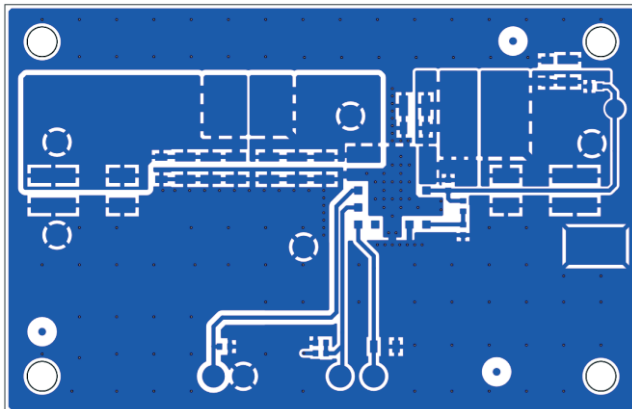

Layer 2 (GND)

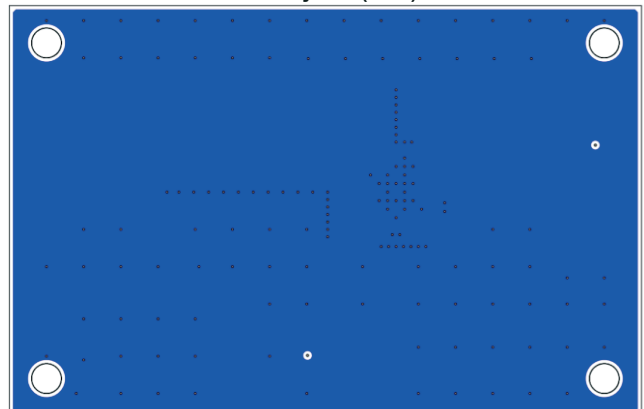

Layer 3 (Single)



Bottom (GND)

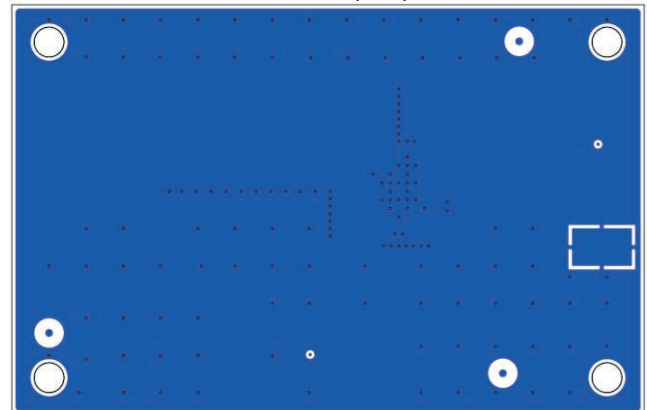

**Notes:**

Note2: Visit [www.recom-power.com/eval-ref-boards](http://www.recom-power.com/eval-ref-boards) to download the Gerber files.

**Specifications** (measured @ Ta= 25°C, full load after warm up unless otherwise stated)

**BOM**

RPMH3.3-0.5-EVM-1 or RPMH5.0-0.5-EVM-1

Component	Description	Manufacturer Part Number	Manufacturer	Remarks
C1	1206			Not Mounted
C2	1210			Not Mounted
C3	2.2µF 100V X7R 1210	12101C225KAT4A	AVX	
C4	1210			Not Mounted
C5	4.7µF 100V X7R 1210	12101C475K4T2A	AVX	X7S as alternate
C6	22µF 10V X7R 1206	1206ZC226KAT2A	AVX	
C7	1210			Not Mounted
C8	1206			Not Mounted
C9	1210			Not Mounted
C10	1206			Not Mounted
C11	1210			Not Mounted
C12	4.7µF 100V X7R 1210	12101C475K4T2A	AVX	X7S as alternate
L1	8.8mm x 4.75mm			Not Mounted
L2	1206			Not Mounted
L3	0805			Not Mounted
L4	FIXED INDUCTOR 12µH 0.8A	RLS-126	RECOM	
L5	8.8mm x 4.75mm			Not Mounted
L6	1206			Not Mounted
L7	0 OHM JUMPER 0805 0W125	CRCW08050000Z0ECC	VISHAY	Use 0R 0805
L8	0603			Not Mounted
L9	11.68mm x 7.2mm			Not Mounted
P1	CONNECTOR	695402400222	WURTH	
P2	CONNECTOR	695402400222	WURTH	
R1	0 OHM JUMPER 0603 0W1	CRCW06030000Z0EAC	VISHAY	
R2	0 OHM JUMPER 0603 0W1	CRCW06030000Z0EAC	VISHAY	Not Mounted
R4	0603			Not Mounted
R5	0603			Not Mounted
R6	0603			Not Mounted
R9	100K OHM 1% 0603 0W1	CRCW0603100KFKEAC	VISHAY	
R10	100K OHM 1% 0603 0W1	CRCW0603100KFKEAC	VISHAY	Not Mounted
U1	RPMH3.3-0.5 or RPMH5.0-0.5 MODULE	RPMH3.3-0.5 or RPM5.0-0.5	RECOM	3.3Vout version 5.0Vout version

continued on next page

**Specifications** (measured @ Ta= 25°C, full load after warm up unless otherwise stated)

**RPMH12-0.5-EVM-1 or RPMH15-0.5-EVM-1**

Component	Description	Manufacturer Part Number	Manufacturer	Remarks
C1	1206			Not Mounted
C2	1210			Not Mounted
C3	2.2µF 100V X7R 1210	12101C225KAT4A	AVX	
C4	1210			Not Mounted
C5	4.7µF 100V X7R 1210	12101C475K4T2A	AVX	X7S as alternate
C6	1206			Not Mounted
C7	22µF 25V X7R 1210	12103C226KAT2A	AVX	
C8	1206			Not Mounted
C9	1210			Not Mounted
C10	1206			Not Mounted
C11	1210			Not Mounted
C12	4.7µF 100V X7R 1210	12101C475K4T2A	AVX	X7S as alternate
L1	8.8mm x 4.75mm			Not Mounted
L2	1206			Not Mounted
L3	0805			Not Mounted
L4	FIXED INDUCTOR 12µH 0.8A	RLS-126	RECOM	
L5	8.8mm x 4.75mm			Not Mounted
L6	1206			Not Mounted
L7	0 OHM JUMPER 0805 0W125	CRCW08050000Z0ECC	VISHAY	Use 0R 0805
L8	0603			Not Mounted
L9	11.68mm x 7.2mm			Not Mounted
P1	CONNECTOR	695402400222	WURTH	
P2	CONNECTOR	695402400222	WURTH	
R1	0 OHM JUMPER 0603 0W1	CRCW06030000Z0EAC	VISHAY	
R2	0 OHM JUMPER 0603 0W1	CRCW06030000Z0EAC	VISHAY	Not Mounted
R4	0603			Not Mounted
R5	0603			Not Mounted
R6	0603			Not Mounted
R9	100K OHM 1% 0603 0W1	CRCW0603100KFKEAC	VISHAY	
R10	100K OHM 1% 0603 0W1	CRCW0603100KFKEAC	VISHAY	
U1	RPMH12-0.5, RPMH15-0.5 MODULE	RPMH12-0.5 or RPM15-0.5	RECOM	12Vout version 15Vout version

continued on next page

**Specifications** (measured @ Ta= 25°C, full load after warm up unless otherwise stated)

RPMH24-0.5-EVM-1				
Component	Description	Manufacturer Part Number	Manufacturer	Remarks
C1	1206			
C2	1210			Not Mounted
C3	2.2µF 100V X7R 1210	12101C225KAT4A	AVX	
C4	1210			Not Mounted
C5	4.7µF 100V X7R 1210	12101C475K4T2A	AVX	X7S as alternate
C6	1206			Not Mounted
C7	10µF 50V X7R 1210	12105C106KAT2A	AVX	
C8	1206			Not Mounted
C9	10µF 50V X7R 1210	12105C106KAT2A	AVX	Not Mounted
C10	1206			Not Mounted
C11	1210			Not Mounted
C12	4.7µF 100V X7R 1210	12101C475K4T2A	AVX	X7S as alternate
L1	8.8mm x 4.75mm			Not Mounted
L2	1206			Not Mounted
L3	0805			Not Mounted
L4	FIXED INDUCTOR 12µH 0.8A	RLS-126	RECOM	
L5	8.8mm x 4.75mm			Not Mounted
L6	1206			Not Mounted
L7	0 OHM JUMPER 0805 0W125	CRCW08050000Z0ECC	VISHAY	Use 0R 0805
L8	0603			Not Mounted
L9	11.68mm x 7.2mm			Not Mounted
P1	CONNECTOR	695402400222	WURTH	
P2	CONNECTOR	695402400222	WURTH	
R1	0 OHM JUMPER 0603 0W1	CRCW06030000Z0EAC	VISHAY	
R2	0 OHM JUMPER 0603 0W1	CRCW06030000Z0EAC	VISHAY	Not Mounted
R4	0603			Not Mounted
R5	0603			Not Mounted
R6	0603			Not Mounted
R9	100K OHM 1% 0603 0W1	CRCW0603100KFKEAC	VISHAY	
R10	100K OHM 1% 0603 0W1	CRCW0603100KFKEAC	VISHAY	
U1	RPMH24-0.5 MODULE	RPMH24-0.5	RECOM	

### PACKAGING INFORMATION

Parameter	Type	Value
Packaging Dimension (LxWxH)	carton	114.0 x 60.0 x 28.0mm
Packaging Quantity		1 pcs

### Contents

- RPMH-0.5-EVM-1 evaluation module
- Terms and conditions

The product information and specifications may be subject to changes even without prior written notice. The product has been designed for various applications; its suitability lies in the responsibility of each customer. The products are not authorized for use in safety-critical applications without RECOM's explicit written consent. A safety-critical application is an application where a failure may reasonably be expected to endanger or cause loss of life, inflict bodily harm or damage property. The applicant shall indemnify and hold harmless RECOM, its affiliated companies and its representatives against any damage claims in connection with the unauthorized use of RECOM products in such safety-critical applications.