

REVISION			
REV.	DESCRIPTION	DATE	APPROVED

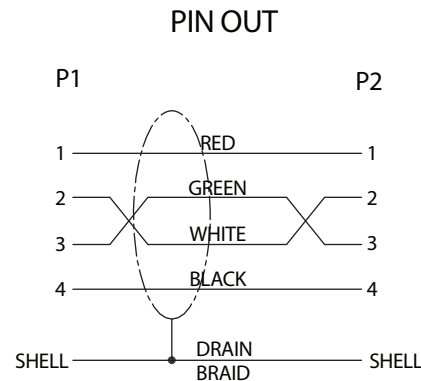
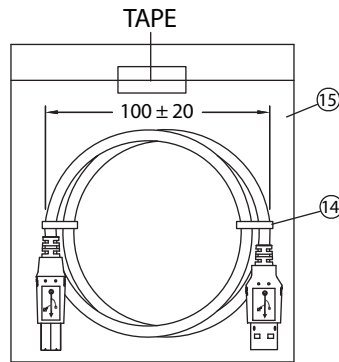
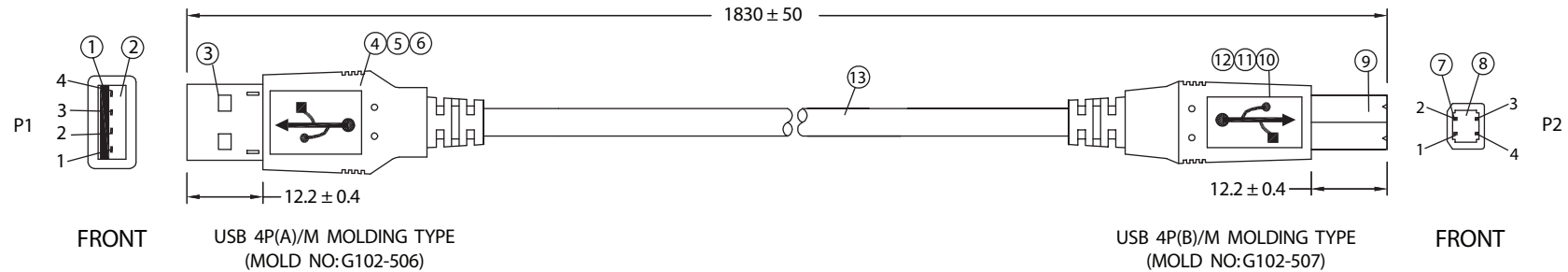

NOTES:

- CABLE: UL2725 26/28AWG
(28AWGx1P+26AWGx2C+FOIL+DW+BD)x1
OD: 4.2 ± 0.2, COLOR: BLACK
PRINTING: "E166307 AWM 2725 26/28AWG 80°C 30V VW-1 HI-SPEED USB2.0"
- CONNECTORS: USB 4P(A) MALE TO USB 4P(B) MALE
- HOOD: MOLDED TYPE
- ELECTRICAL TEST:
 - <1>.100% OPEN SHORT & MISS WIRE TEST
 - <2>.INSULATION RESISTANCE: DC400V 10M ohm MIN.
 - <3>.CONDUCTOR RESISTANCE: 3 ohm MAX.
- PACKING: 1PC/POLYBAG

No.	PARTS NAME	SPECIFICATION STANDARD	QTY	REMARKS
①	USB 4P(A)/M - CONTACT	BRASS / GOLD PLATED (CRIMPING TYPE)	4	
②	USB 4P(A)/M - INSULATOR	PBT + G,F / WHITE UL 94V-0	1	
③	USB 4P(A)/M - SHELL 1	STEEL NICKEL PLATED	1	
④	USB 4P(A)/M - SHELL 2	STEEL NICKEL PLATED	1	
⑤	USB 4P(A)/M - COPPER FOIL	WIDTH 5xLENGTH 27	1	
⑥	USB 4P(A)/M - OUTER MOLD	45P PVC / COLOR: BLACK	1	
⑦	USB 4P(B)/M - CONTACT	BRASS / GOLD PLATED (CRIMPING TYPE)	4	
⑧	USB 4P(B)/M - INSULATOR	PBT + G,F / WHITE UL 94V-0	1	
⑨	USB 4P(B)/M - SHELL 1	STEEL NICKEL PLATED	1	
⑩	USB 4P(B)/M - SHELL 2	STEEL NICKEL PLATED	1	
⑪	USB 4P(B)/M - COPPER FOIL	WIDTH 5xLENGTH 27	1	
⑫	USB 4P(B)/M - OUTER MOLD	45P PVC / COLOR: BLACK	1	
⑬	CABLE	L01009ABK01A	1	
⑭	MINI TIE	PE / BLACK	2	
⑮	POLYBAG	PE: 0.08x140x160	1	

Dim range (mm)	Tolerance +/- (mm)	Qualtek Electronics Corp. WCT DIVISION		
		Part Number: 3021007-06		
0-1	0.15	Description: USB 4P(A)/M - USB 4P(B)/M		
1-6	0.20			
6-18	0.30			
18-50	0.50			
50-120	0.70	Drawn / Date	Checked / Date	Approved / Date
120-250	0.90	B.Grubb 01-26-07	01-26-07	JJH / 01-26-07
250-500	1.20			