

QT-Brightek PLCC Series

Dome Type PLCC2 LED

Part No.: QBLP670D Series

Product: QBLP670D Series	Date: August 07, 2018	Page 1 of 13
	Version# 1.6	

Table of Contents:

Introduction	3
Electrical / Optical Characteristic (Ta=25 °C)	4
Absolute Maximum Rating	4
Characteristic Curves.....	7
Solder Profile & Footprint.....	9
Recommended Handling Precautions.....	10
Packing	11
Labeling	12
Ordering Information	12
Revision History	13
Disclaimer	13

Introduction

Feature:

- Water Clear lens
- Ultra bright dome type PLCC2 LED
- AlInGaP technology for R/S/Y/O/AG
- InGaN technology for IG/BG/IB
- 30 degree viewing angle
- MSL: Level 3

Description:

This dome type PLCC2 LED has a height profile of 3.6mm. Combination of high brightness output and robust package, this LED is ideal for architecture lighting, status indication, and color mixing applications.

Application:

- Status indication
- Industrial equipment backlighting
- Architecture lighting

Certification & Compliance:

- TS16949
- ISO9001
- RoHS Compliant



Dimension:

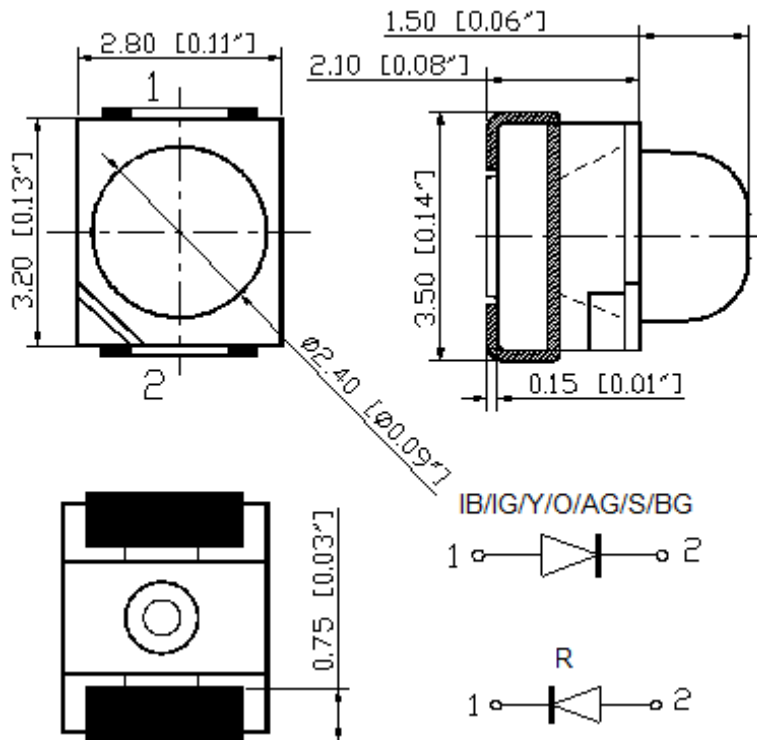

Units: mm / tolerance = +/-0.2mm

Electrical / Optical Characteristic (Ta=25 °C)

Product	Color	I _F (mA)	V _F (V)		λ _D (nm)			I _V (mcd)	
			Typ.	Max.	Min.	Typ.	Max.	Min.	Typ.
QBLP670D-R	Red	20	2.0	2.5	620	625	630	2000	3500
QBLP670D-S	Deep Red	20	2.0	2.5	625	630	635	500	900
QBLP670D-Y	Yellow	20	2.1	2.5	585	590	595	1000	1700
QBLP670D-AG	Yellow Green	20	2.0	2.5	565	570	576	200	400
QBLP670D-O	Orange	20	2.0	2.5	600	605	610	1250	2000
QBLP670D-IG	True Green	20	3.3	3.7	520	525	530	5200	9500
QBLP670D-BG	Cyan	20	3.3	3.7	500	505	510	2000	3400
QBLP670D-IB	Blue	20	3.2	3.7	465	470	475	500	900

Absolute Maximum Rating

Material	P _d (mW)	I _F (mA)	I _{FP} (mA)*	V _R (V)	T _{OP} (°C)	T _{ST} (°C)
AllnGaP	75	30	125	5	-40 ~ +80	-40 ~ +85
InGaN	111	30	125	5	-40 ~+80	-40 ~+85

*Duty 1/8 @ 1KHz

Forward Voltage V_F for AllnGaP @ I_F=20mA

Bin	Min.	Max.	Unit
□	1.7	2.5	V

Forward Voltage V_F for InGaN @ I_F=20mA

Bin	Min.	Max.	Unit
f	2.8	3.1	V
g	3.1	3.4	
h	3.4	3.7	

Luminous Intensity I_V @ $I_F=20mA$

Bin	Min.	Max.	Unit
M	200	250	mcd
N	250	320	
O	320	400	
P	400	500	
Q	500	630	
R	630	800	
S	800	1000	
T	1000	1250	
U	1250	1600	
V	1600	2000	
W	2000	2500	
X	2500	3200	
Y	3200	4000	
Z	4000	5200	
a	5200	6800	
b	6800	8800	
c	8800	11200	
d	11200	14200	

Dominant Wavelength λ_D for Red @ $I_F=20mA$

Bin	Min.	Max.	Unit
t	620	625	nm
u	625	630	

Dominant Wavelength λ_D for Deep Red @ $I_F=20mA$

Bin	Min.	Max.	Unit
u	625	630	nm
v	630	635	

Dominant Wavelength λ_D for Yellow @ $I_F=20mA$

Bin	Min.	Max.	Unit
m	585	590	nm
n	590	595	

Dominant Wavelength λ_D for Orange @ $I_F=20mA$

Bin	Min.	Max.	Unit
p	600	605	nm
q	605	610	

Dominant Wavelength λ_D for True Green @ $I_F=20mA$

Bin	Min.	Max.	Unit
U	520	522.5	nm
V	522.5	525	
W	525	527.5	
X	527.5	530	

Dominant Wavelength λ_D for Yellow Green @ $I_F=20mA$

Bin	Min.	Max.	Unit
h	565	568	nm
i	568	572	
j	572	576	

Dominant Wavelength λ_D for Cyan @ $I_F=20mA$

Bin	Min.	Max.	Unit
M	500	502.5	nm
N	502.5	505	
O	505	507.5	
P	507.5	510	

Dominant Wavelength λ_D for Blue @ $I_F=20mA$

Bin	Min.	Max.	Unit
G	465	467.5	nm
H	467.5	470	
I	470	472.5	
J	472.5	475	

Note:

- Tolerance of measurement of forward voltage: $\pm 0.1V$
- Tolerance of measurement of dominant wavelength: $\pm 1nm$
- Tolerance of measurement of luminous intensity: $\pm 15\%$
- All parameters are measured by QT-Brightek equipment

Characteristic Curves

AllInGaP

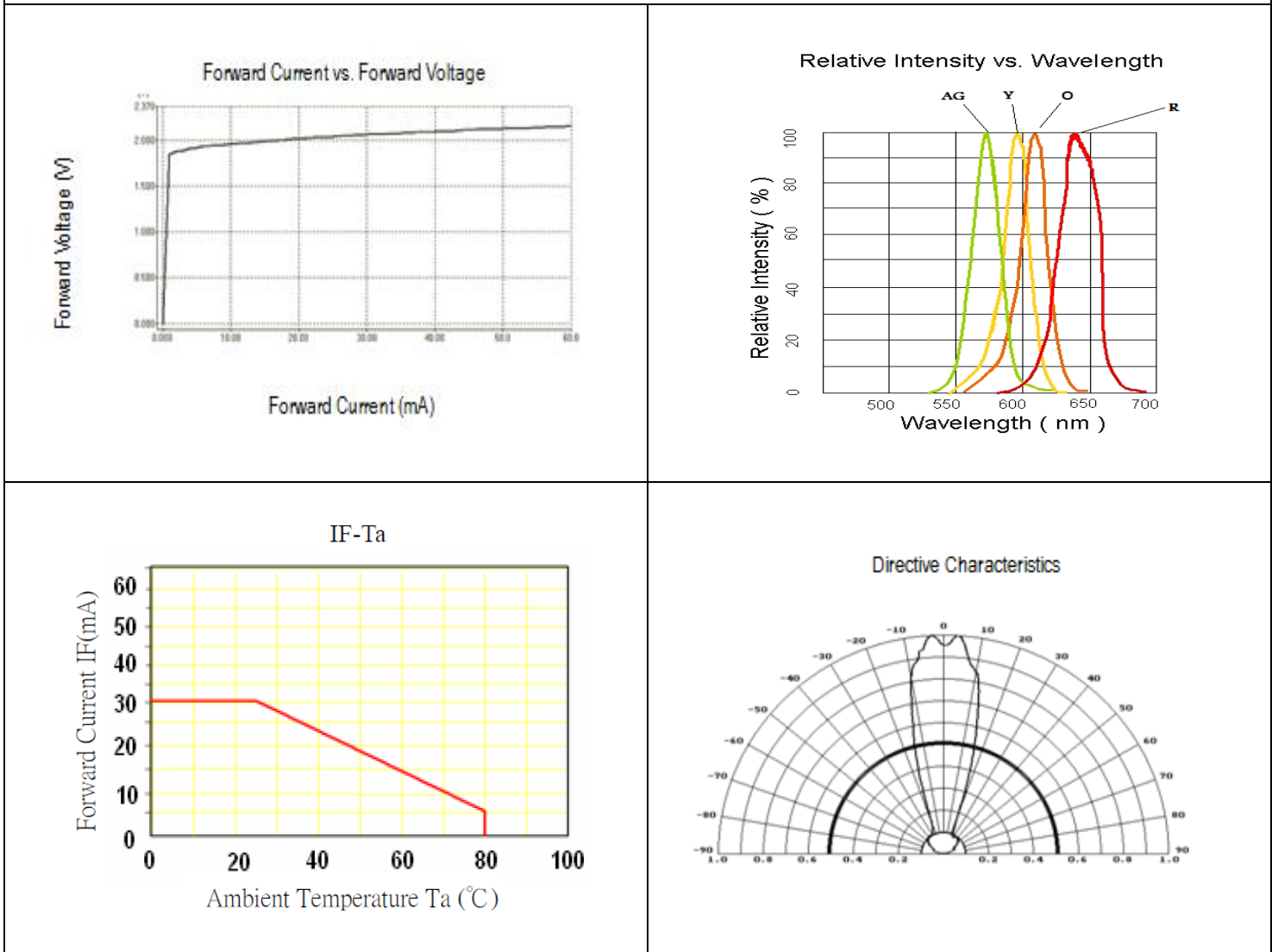

InGaN

Forward Current vs. Forward Voltage

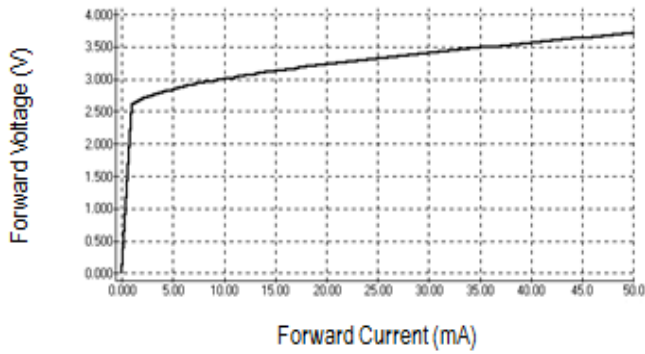

Relative Intensity vs. Wavelength

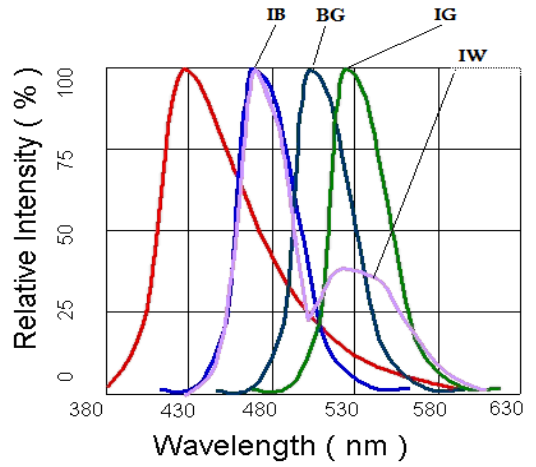

IF-Ta

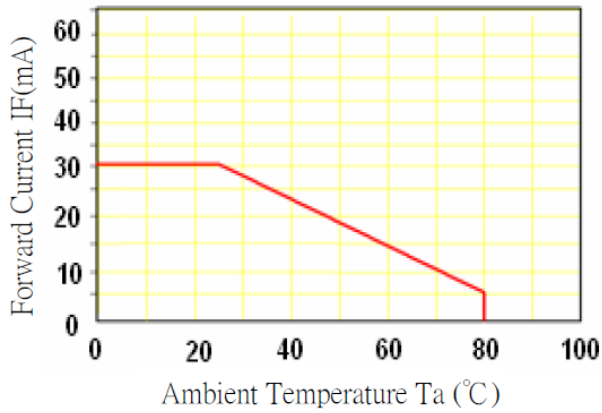

Directive Characteristics

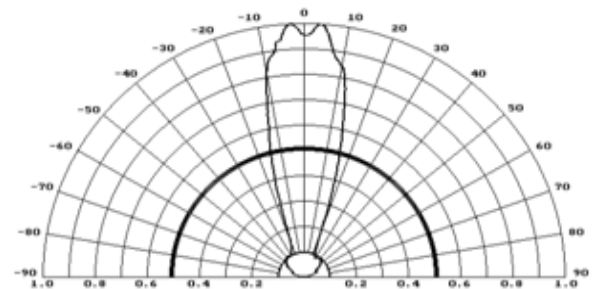

Solder Profile & Footprint

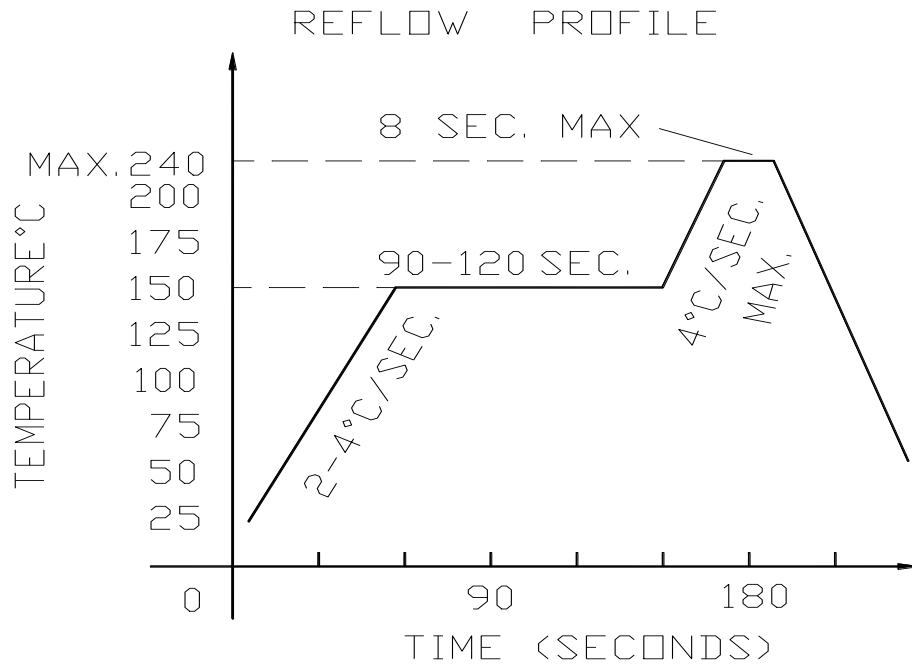

Recommended Pad Layout

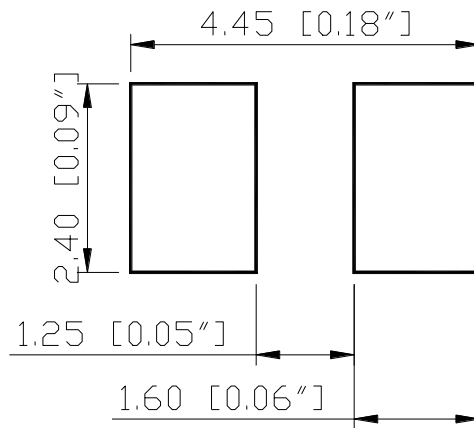

Units: mm

Tolerance: ± 0.2mm

Recommended Handling Precautions

1. It is recommended to store the products in sealed and anti-static bags with desiccant inside at the following condition:
 - Humidity: <60% RH
 - Temperature: 5°C~30°C
2. Shelf life in sealed bag: 12 month at 5°C~30°C and < 60% R.H
3. After the package is opened:
 - 3.1 The products should be used within a week (168 hours)
 - 3.2 Or product should be stored at $\leq 20\%$ RH and (5°C~30°C) with zip-lock sealed bag
 - 3.3 It is recommended to bake before soldering when the package is unsealed after 72hrs;
 - 3.3.1 Baking condition (Tape and Reel Type): $60\pm 3^\circ\text{C}$ (24~36 hrs) and < 5% RH
 - 3.4 Products require baking before soldering/mounting if **3.1** or **3.2** is not met. Baking condition refers to **3.3.1**
4. If the product is not used within 3 months since manufacturing date, it is recommended to bake for 24 hrs @ 60°C before use.
5. If the product is not used after 3 months since manufacturing date, it is recommended to bake for 36~48 hrs @ 60°C before use.

Product: QBLP670D Series	Date: August 07, 2018	Page 10 of 13
	Version# 1.6	

Labeling



Part No: _____
Customer P/N: _____
Item: _____
Q'ty: _____
Vf: _____
Iv: _____
WI: _____
Date: _____

Made in China

Ordering Information

Part #	Orderable Part #	Spec Range	Quantity per Reel
QBLP670D-R	QBLP670D-R	Iv=3500mcd typ. @ I _F =20mA / λ _D =620nm to 630nm	2,000 units
QBLP670D-S	QBLP670D-S	Iv=900mcd typ. @ I _F =20mA / λ _D =625nm to 635nm	2,000 units
QBLP670D-Y	QBLP670D-Y	Iv=1700mcd typ. @ I _F =20mA / λ _D =585nm to 595nm	2,000 units
QBLP670D-O	QBLP670D-O	Iv=2000mcd typ. @ I _F =20mA / λ _D =600nm to 610nm	2,000 units
QBLP670D-AG	QBLP670D-AG	Iv=400mcd typ. @ I _F =20mA / λ _D =565nm to 576nm	2,000 units
QBLP670D-IG	QBLP670D-IG	Iv=9500mcd typ. @ I _F =20mA / λ _D =520nm to 530nm	2,000 units
QBLP670D-BG	QBLP670D-BG	Iv=3400mcd typ. @ I _F =20mA / λ _D =500nm to 510nm	2,000 units
QBLP670D-IB	QBLP670D-IB	Iv=900mcd typ. @ I _F =20mA / λ _D =465nm to 475nm	2,000 units

Revision History

Description:	Revision #	Revision Date
New Release of QBLP670D Series	V1.0	02/13/2013
Update spec and drawing	V1.1	03/26/2014
Add yellow green and deep red	V1.2	04/01/2014
Add cyan color	V1.3	09/23/2014
Add orange color	V1.4	01/19/2015
Fix wavelength bin code typo for yellow green (AG)	V1.5	12/03/2015
Update Iv for Green due to brightness improvement	V1.6	08/07/2018

Disclaimer

QT-BRIGHTEK reserves the right to make changes without further notice to any products herein to improve reliability, function or design. QT-BRIGHTEK does not assume any liability arising out of the application or use of any product or circuit described herein; neither does it convey any license under its patent rights, nor the rights of others.

Life Support Policy

QT-BRIGHTEK's products are not authorized for use as critical components in life support devices or systems without the express written approval of QT-BRIGHTEK. As used herein:

1. Life support devices or systems are devices or systems which, (a) are intended for surgical implant into the body, or (b) support or sustain life, and (c) whose failure to perform when properly used in accordance with instructions for use provided in the labeling, can be reasonably expected to result in a significant injury of the user.
2. A critical component in any component of a life support device or system whose failure to perform can be reasonably expected to cause the failure of the life support device or system, or to affect its safety or effectiveness.