



PulseLARSEN *Antennas*

SourceBook • Version 15



PulseLarsen Antennas is pleased to bring you the new, improved Antenna SourceBook (ASB), Volume 15. The goal of the ASB is to provide you with a "go to" source for all your antenna needs.



As the demand for wireless connectivity flourishes Pulse/Larsen is here with the needed solutions. We offer a unique far-reaching understanding of antenna and RF technology and have become the partner of choice for leading industry innovators. Pulse offers excellent value and outstanding quality products delivered from our high-volume production facilities. We offer a wide array of antennas covering 2G/ 3G/ 4G/5G , LTE, MiMo applications, WiFi, 2.4GHz, 5GHz, Zigbee, Bluetooth, GPS/ Glonass/ Beidou /

Compass/ Galileo, any ISM frequency bands (169, 315, 433, 450, 868, 915, 2.4GHz), UHF, VHF, FM, DSRC, V2X, UWB and other applications.

You can rely on PulseLarsen to be your trusted antenna partner. We have been in the antenna business over 50 years and have exceeded over 2 Billion antennas shipped during that time. We supply consistent high-quality products by owning and fully controlling our own factories in both China and the United States. On the following pages you will find our more popular antennas. For an up-to-the-minute view of our offering visit our website at www.pulselarsenantennas.com.



CONTACT US TODAY!

-  Call us at **+1.800.ANTENNA**
-  Visit our website at **pulselarsenantennas.com**
-  Connect with us on twitter **PulseLarsen1**

- **How To Work With Us, Capabilities & Product Categories**4-23
- **New Products and Sample Kit** 8-9
- **Selection Guides**8-29
- **External Antennas** 30-31
- **Portable Radio Antennas**
 - **Performance Chart and KuLDUCKIE** 31-34
 - **SPOTS!** 35-39
- **Mobile Series Designation** 40-41
- **Low Band 27-136 MHz**42-51
 - **VHF 136-220 MHz** 41-43
 - **UHF 406-512 MHz** 44-46
 - **Multi Band VHF/UHF** 47
 - **Tunable 1/4 Wave 136-512 MHz** 48
- **700/800/900/1850 MHz** 52
 - **GPS** 52-58
 - **Multi-Band Data Antennas** 59-67
 - **Outdoor Vehicular: LTE, 4G, Broadband** 68-69
 - **Outdoor Antennas** 70
 - **Base Station Antennas** 71
- **DAS** 72-77
- **Cable Assemblies/Mounts** 78-83
- **Connectors** 84-87
 - **Parts/Accessories** 88-91
 - **Brackets** 92-93
 - **Coaxial Cables** 94-95



Pulse continues as an Innovative Leader!

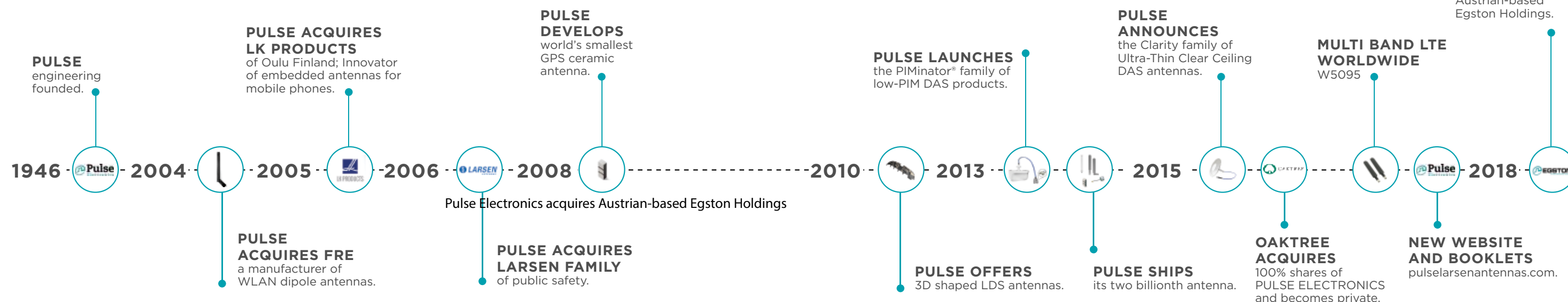



Distribution

PulseLarsen has partnered with the industry’s leading wireless product distributors and sales representatives throughout the World. Our antennas are as close as a phone call away. Please find a list of our distributor and their live inventory on our website at: www.pulselarsenantennas.com and experience our “BUY NOW” button features.

Please find a list of our sales representatives and their dedicated territories at the following address:

1-800-ANTENNA (268-3662)

When you need an antenna, what better way than to remember 1-800-ANTENNA (268-3662). Our knowledgeable Customer Support staff is available to assist you.

For our international customers:

PHONE +1-360-944-7551

EMAIL

Americas: antennas.us@pulseelectronics.com

Europe: antennas.eu@pulseelectronics.com

Asia: antennas.as@pulseelectronics.com

Ordering

At PulseLarsen we understand managing your business in today’s rapidly changing wireless communications market can be complicated. We want to make the process of doing business with us as easy as possible.

Whether it’s your first order or you’ve been doing business with us for a while, each and every customer is equally important to us. From our experienced customer service associates to the latest in communications technologies, Pulse/Larsen strives to exceed your expectations with every transaction.

To order products, contact one of our authorized distributors. For a list of distributors, visit our web site at www.pulselarsenantennas.com.



PULSE No-Nonsense™ Warranty

Every effort is made to assure the integrity and long life of each Pulse product. In the unfortunate event a problem does occur, you will find us ready to make it right!

Duration of warranty is one year from date of purchase.

Pulse will repair or replace without charge any Larsen antenna product which fails for any reason during the warranty period. Pulse is not responsible for any incidental or consequential damages due to failure of the antenna under this warranty or any implied warranty. This exclusion may not apply to all areas of the USA or Canada.

Manufacturing Capabilities - Available Traditional Technologies

- Stamping
- Plastic injection molding
- Heatstaking
- Welding (Spot, USW, Induction)
- Plasma Treatment
- Acoustic Module Testing (THD, SPL)
- Flexible Printed Circuit
- PAD printing, Painting
- In-House Ceramic Process
- Any Cable Assemblies
- Any Connector Mounts
- PIM Testing
- SMD Process
- Automatic Cable Stripping
- Epoxy resins and Glue deposition
- Plastic Dipping
- RF Testing
- Any Connector Mounts
- Auto Packaging and Labeling

State of the Art - 3D Technologies

- Laser Direct Structuring (LDS): 3D techniques using LPKF laser processing and Plating.
- Pulse FLUIDWRITER Technology: In-House 3d patented technology based on 3d deposition of conductive ink directly on plastic surface followed by low temperature curing process. Ideal process to build identical samples and mass production parts.

Prototyping Abilities Worldwide (AMERICAS, EMEA, ASIA)

- 3D printing plastic parts, FR4 or Stamping parts using LPKF machines, CNC, Plastisol Dipping techniques, Lathes, Milling machines...

Testing Services

Testing Capabilities for Product Qualification and Design Validation

ELECTRICAL

- S-Parameters using VNA up to 14GHz
- Impedance
- Insertion Losses
- Isolation
- Acoustic Parameters (THD, SPL)
- S.A.R. using Daisy 4 & 5
- Body Loading using phantom Hands and Heads
- Portable VNA for on-site Tuning with customers
- 3D radiation Patterns using Worldwide anechoic chambers Satimo/ETS)
- 3D RF simulation tools (CST, Optenni, Ibwave, AWR)
- WiFi Throughout testing using IXIA Chariot
- Expertise in advance RF behaviours with/without body loading/ Embedded in device or in Free Space

MECHANICAL

- Ability to use Solidworks, Catia VS, Pro E, ProgeCAD
- 3d fitting and rendering
- Mechanical Shock
- Solderability
- Tensile Strength
- Pull Force
- Torque testing
- Surface Profilometer

ENVIRONMENTAL

- ESD enviroment for Production &/or Design
- Humidity (to 90% RH)
- Moisture Resistance
- Thermal Shock
- Thermal Cycling with/without salt mist
- Aging
- Vibrations

NOTE: Full EMC Standards Compliance Testing in Germany for any vehicle size (Truck, Car, Tractor, Escalator, Agricultural machines and IoT).

 CHANGES / CONDITIONS: Continual research and development make it necessary for Pulse to reserve the right to make exceptions to or changes in policies, specifications and prices without notice.

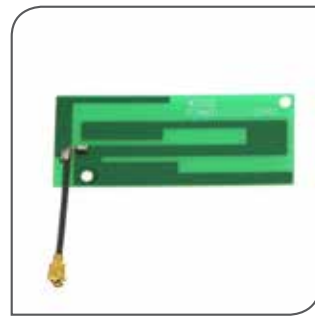
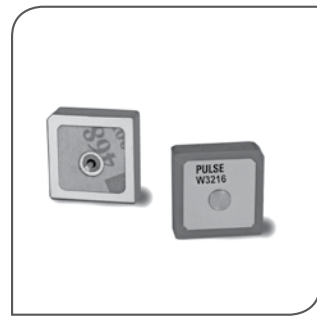

EMBEDDED

Any antenna that can be surface mounted on the customer's PCB or embedded in the device. In that category fall the helices, the Ceramic HTC antennas, the coils, and the composite material antennas.

INTERNAL

Any antenna that are embedded in the customer's device but not visible from the outside, such as the cabled solutions based on FR4 and FPC, the active GPS modules & the NFC antennas.

EXTERNAL

That category is represented by the DAS antennas, the YAGI family, the Radome Omni family and the portables antennas.

OUTDOOR/VEHICULAR

Any antenna that can be mounted on top of a vehicle using connectors or a cable assembly with various types of connectors.

ANTENNA INTEGRATION FOR EMBEDDED AND INTERNAL ANTENNAS

Pulse can assist your engineering team to place/fix the antenna on your PCB board / in the housing of the device. Antenna position, orientation, cable routing and surrounding environment like shielding case, USB port connector, etc; can all impact the efficiency of the antenna inside the device.

Most embedded antennas needs a specific size of ground clearance on the PCB board for best performance. Our standard catalog embedded parts are measured on evaluation board with a size that is more commonly used.

PCB-based antennas are best placed on flat surfaces for both physical and RF stability with the surrounding structure. Adhesives, slots, or snap-in features can be designed to hold antennas in place FPC-based antennas are provided with adhesive tape for easy assembly in the device.

	Embedded Applications	External Applications
SMD / MINIATURE SOLUTIONS	<p>Helical Antennas: High Efficiency 3D molded antennas for SMD process. Ideal for KeyFOB products and other small PCB footprint areas (ISM 315MHz, 2.4GHz, 1.575GHz, ISM 433MHz).</p> <p>Ceramic Antennas: In-house ceramic manufacturing process allowing world smallest and most efficient compact antennas. All frequencies available such as: WiFi, BT, BLE, Zigbee, ISM, GPS, WiFi & GPS, GPS/GNSS/Beidu, Dual Band GSM.</p> <p>Composite Antennas: Ideal for cellular type of applications (2G/3G/4G) requiring compact and efficient antenna form factors.</p>	<p>DAS Family: Indoor LTE MIMO & SISO World Class Solutions (CLARITY: ultra thin 8.3mm height, translucent, high cosmetic finish) & (TRADITIONAL: Bulky Products) available with N, 4.3-10, mini-DIN connectors.</p> <p>Traditional Blade Antennas, Outdoor Radome Omnis and Yagis are available. Weather Proof IP65/67 Products, Direct Mount, with or w/o Bracket, Dipoles (Straight, Right angles), Radome Omni. All frequency bands available from 600MHz to 6GHz (Wlan, WiFi, GPS, 2G, 3G, 4G, LTE, UHF, VHF, Multi bands).</p>
	<p>Cabled Antenna Solutions: Embedded within the device using low loss RF cables and standard connectors of your choice. Antenna substrate is based on FR4 and FPC. Antennas are mechanically fit within the design using snap-in features, adhesive, ribs or hooks.</p> <p>2G/3G Solutions: WiFi Solutions: </p> <p>3G/4G Solutions: </p>	<p>Pulse/Larsen develops all types of mounting, cables and connector solutions for vehicular applications. Any requirements from OEM, ODM or after market customers are available from 50MHz to 6GHz. Any Mounting solutions (Direct, Magnet, Adhesive). Any cable type and length & any connector types are available upon request.</p> <p>NMO Mount: Pulse/Larsen is the patent holder of the world renowned NMO MOUNT facilitating the antenna installation for vehicular applications.</p>
	<p>NFC Solutions: Wide Range of 13.56MHz antennas with various shapes and dimensions on FPC substrate.</p>	

LIGHTING	NARROW BAND NETWORKS	BRACKETS LITE	MEDICAL	RUGGED INDUSTRIAL	INDUSTRIAL
SMART HOMES & SMART CITIES	INTERNAL FLEXIBLE SOLUTIONS FOR WIRELESS PRODUCTS	AUTOMOTIVE	DSRC, V2X	MULTI-BAND SOLUTIONS	CELLULAR MODEM CROSS REFERENCE
CARRIER PUBLIC SAFETY DAS	PUBLIC SAFETY SOLUTIONS FOR FIRSTNET	PORTABLES	AMATEUR RADIOS	CABLE MOUNT ACCESSORIES	OUTDOOR ANTENNAS
FEMTOCELL	BASE STATION	SMART METERING	INFOTAINMENT & NAVIGATION	PAYMENT TERMINALS	

View our category booklets on the website to learn more: pulselarsenantennas.com

NEW

tNo	New Products	Page
1	Antenna Sample Kit and Evaluation Board -IOTest-Kit, ISM-K, LORA-K, FLEX-K, LTE-M, IOT-K	9
2	Embedded ISM antennas -W3136,W3139,W3401,W3403,W3211,W3214,W3215,W3329,W3330	10-11
3	Embedded 2.4&5GHz antennas -W3004,W3008G,W3317,W3712,W3713,W3714,W3716,W3229,W3230	12-13
4	Embedded GPS/GLONASS/BEIDOU Application -W3207,W3212,W3227,W3228	14-15
5	Embedded UWB for Wireless Sensors -W3340,W3540	16-17
6	Internal Antenna -W3929B0100	18-19
7	Internal Active GPS Modules -GPSMOD1315, GPSMOD1333, GPSMOD2515, GPSMOD2533	20-21
8	Internal NFC Application -W3509	22-23
9	External for Multiband Application -W1095,W1095k,W1096,W1089,SPDA24617/3700	24-25
10	Automotive Grade Antenna -New automotive selection with AEC-Q200 qualified antennas	26-29
11	External Antennas -W1039B030	30
12	Skyline Series - Dualband Portable Antennas -SLHL23365,SLWH23415,SLHL24365,SLWH24415	32

tNo	New Products	Page
13	Mobile Whips Designation -Explains part numbering rule for mobile whips	40-41
14	VHF 220MHz Antenna -NMO220CS	45
15	Triband Whip Antenna -NMO150/450/758	49
16	Small molded 700 Band Antenna -NMOC/P3E770	52
17	Low Profile 800/900 Band antenna -LP800SMA,LP800SMAF,LP800SMA3	53
18	GNSS Direct Mount -GNSSDM26B0500	57
19	Stealth Blade Combo with GNSS -W4120GNSS5000	58
20	Jaguar Series -W1919	59
21	Disc Series -extended variant for cable and connector type	60
22	Sharkfin Series -GNSS700/5800SSS	61
23	Panther Series -qualified for railway standards	66-67
24	LTE Magnetic Mount Antenna -LPT698/3800MM,LPT698/3800MM200	69
25	Radome Omni Antenna -RO2202NF	70
26	Low Loss Coaxial Cable -W90XX	78
27	New Bracket Page -ROKIT, BRK0003	92-93

PulseLarsen is catering a variety of Antenna Sample Kit to various application, eg for LTE Cat M1, LORA, ISM and etc . PulseLarsen aims to decrease engineering time by providing a variety of off-the-shelf antenna to developers to plug and test antenna performance, and finding the perfect solution to fit into device.



MODEL IOTEST-KIT

IOTest is the ultimate antenna kit for startup developers. It includes a reflector meter from Copper Mountain, a calibration kit, multiple antenna evaluation board from PulseLarsen. The reflector meter is ready to work with a software installed on laptop. The software also includes antenna basic knowledge , common difficulty faced during antenna design and etc.



MODEL ISM-K

ISM-K sample kit has the collection of the ISM band favourites antenna.



MODEL LTE-M

LTE-M Antenna Kit has the collection of LTE antenna sizes PulseLarsen offers, such as small surface mount antenna for embedding on PCB, blade/ stick antenna for external placement of device but for indoor usage , and weatherproof LTE antenna for outdoor environment.



MODEL LORA-K

LORA-K sample kit includes a diversity of antenna with operating frequency working for LORA application



MODEL IOT-K

IOT-K sample kit offers a variety of smaller profile antenna that are commonly used for Internet of Things application.



MODEL FLEX-K

Flex-K sample kit includes a diversity of flexible printed board antenna with coaxial cable operating a different frequency bands. The FPC-based antennas comes with adhesive tape for easy assembly in the device.

ANTENNA EVALUATION BOARD

PulseLarsen offers antenna evaluation board for all embedded antenna. Evaluation board kit comes with a ready-to-test reference board and a few extra loose embedded antenna.

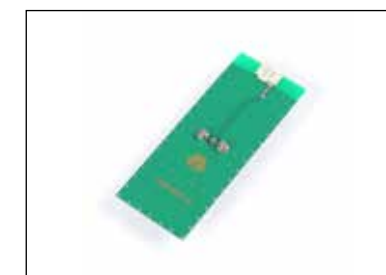

APP.	TYPE	PULSE PART NUMBER	RF PERFORMANCE						ME REQUIREMENT			NOTE
			FREQUENCY RANGE (MHZ)	RL MIN. (DB)	PEAK GAIN (DBI)		EFFICIENCY (%)		ANTENNA DIM. (LXWXH,MM)	GC-AREA (L X W,MM)	EVALUATION BOARD SIZE (L X W,MM)	
					PEAK	BAND EDGES	PEAK	BAND EDGES				
868MHZ (867MHZ-870MHZ)	CERAMIC CHIP	W3000	868-870	-15	-1.4	-1.5	30	29	7 X 1.6 X 1.6	20 X 9.50	40 X 20	Top center, tuned by stripline on PCB
		W3013	868-870	-11	1.5	1.4	65	64	10 X 3.2 X 4.0	10.80 X 8.25	80 X 37	Center edge
		W3016	868-870	-19	-2.2	-2.5	25	23	10 X 3.2 X 4.0	11.50 X 7	25 X 25	Corner, Small GC-area and PCB
		W3214	863-873	-20	1	-3	55	20	10 X 3.2 X 5	10.8 X 8.25	120 X 37	On Ground Solution. Center Edge
	COMPOSITE	W3329	860-870	-10	0.17	-	60	-	21.85 X 5 X 3	37.51 X 8.30	128.64 X 37.51	Top center, MSL (3)
	HELICAL	W3117	869-894	-9	0	-1.3	56	40	12.4 X 8 X 2.5	8 X 40	100 X 40	Horizontal, Top center
		W3118A	869-894	-9	0	-1.4	52	38	2.5 X 8 X 8	6 X 11	100 X 40	Vertical, Corner
		W3139	860-880	-8	-2	-3.5	35	26	14 X 3 X 3.3	4.2 X 40	121 X 40	Small GC: Series 11nH + Shunt 9.1pF Large GC: Series 20nH + Shunt 6.8pF
LDS	W3401	868	-6	-	-	40	-	59 X 6 X 15.5	-	65 X 65	SMD mount LDS antenna on carrier	
915MHZ (902MHZ-928MHZ)	CERAMIC CHIP	W3012	902-928	-6	2	0.5	70	50	10 X 3.2 X 4	10.80 X 8.25	100 X 37	Center edge
		W3014	880-960	-7	-0.5	-	45	40	10 X 3.2 X 1.5	40 X 16	96 X 40	Top center
		W3211	902-928	-10	1.5	-2	55	25	10 X 3.2 X 5	10.8 X 8.25	120 X 37	On Ground Solution. Center Edge
	CERAMIC PATCH	W3215	902-928	-20	4.5	2.5	70	50	40 X 40 X 6	-	150 X 150	
	HELICAL	W3112A	902-928	-10	0.9	-0.3	67	50	2.5 X 8 X 8	6 X 11	100 X 40	Vertical, Corner
		W3113	902-928	-10	0.8	-0.3	66	51	12.4 X 8 X 2.5	8 X 40	100 X 40	Horizontal, Top center
		W3139	902-928	-8	-1.8	-2.8	35	28	14 X 3 X 3.3	4.2 X 40	121 X 40	Small GC: Series 9.5nH + Shunt 9.1pF Large GC: Series 18nH + Shunt 5.1pF
DUAL 868/ 915 MHZ	HELICAL	W3136	860-930	-7	2	1.0	68	50	29.5 X 8 X 7.6	9.5 X 40	121 X 40	Top center
	STAMPING	W3403	868-920	-10	-1.5	-	30	30	39 X 14 X 4.8	-	67.8 X 39.6	PIFA with traces on board.
COMBO 868/915MHZ AND 2.4GHZ	CERAMIC CHIP	W3320	863-928	-8	1.5	0.8	67	55	10 X 3.2 X 2	10.78 X 9.5	120 X 50	Center edge, Dual feed
			2400-2500	-6	3.4	1.4	61	45		4.65 X 3.95		
	COMPOSITE	W3330	844-928	-6	0.9	0.2	67	52	25.1 X 5 X 3	40 X 8.65	128.64 X 40	Top Center, Dual feed
			2400-2500	-8	2.5	1.8	66	60				
	DIRECT PCB	W3331	863-928	-6	1.7	0.9	64	53	45 X 10 X 0.8	45 X 4.5	119 X 102	Corner, Small GC-area and PCB, Dual feeds
			2400-2500	-12	4	1.5	85	69				
DIRECT PCB	W3333	863-928	-8	2.4	1.8	75	-	40 X 15 X 0.8	40 X 4.5	119 X 102	Corner, Small GC-area and PCB, Dual feeds	
		2400-2500	-12	4.5	3.0	85	66					
433MHZ	CERAMIC CHIP	W3015L	433 +/- 1	-10	-2.5	-	35	-	10 X 3.2 X 4.0	10.80 X 14	200 X 37	Center edge
	HELICAL	W3127	433-435	-15	-2.9	-	-	-	35.35 X 9.90	8 X 40	100 X 40	Top Center
315 MHZ	HELICAL	W3126	315	-10	-5	-	-	-	35.35 X 9.90	8 X 40	100 X 40	Top Center
169 MHZ	HELICAL	W3100	169MHZ	-10	-4	-	55	-	91 X 9.8	-	95 X 45	coil on free space.

Note:
 1)GPSMBMM is a magnetic mounting base option for Panther Series antenna.
 2)Panther Series has models that are compliant with railroad standards EN50155, EN61373 and EN45545-2. Contact factory for more information.
 3)Frequency details for GNSS: 1561.098MHz±2.06/1575.42MHz±1.023/1602.5625MHz±4

APP.	TYPE	PULSE PART NUMBER	RF PERFORMANCE						ME REQUIREMENT			NOTE
			OPERATING FREQUENCY (MHZ)	RL MIN. (DB)	PEAK GAIN (DBI)		EFFICIENCY (%)		ANTENNA DIM. (LXWXH,MM)	GC-AREA (L X W,MM)	EVALUATION BOARD SIZE (L X W,MM)	
					PEAK	BAND EDGES	PEAK	BAND EDGES				
SINGLE WIFI, BT, ZIGBEE	CERAMIC CHIP	W3000	2400-2483.5	-18	2.5	2.1	65	55	7 x 1.6 x 1.6	6.00 x 11.00	40 x 11	3 Matching components Horiz. mount
				-12	2.2	1.5	53	45		6.00 x 20.00	30 x 20	
		W3001		-6	1.5	0.5	75	60	10 x 3.2 x 4.0	10.80 x 6.25	80 x 37	On Ground solution
		W3008		-8	1.7	0.7	70	55	3.2 x 1.6 x 1.1	4.00 x 4.25	80 x 37	
		W3008C		-11	2.2	1.9	75	70	3.2 x 1.6 x 1.1	4.00 x 6.25	80 x 37	
		W3008G		-15	3.8	3.5	90	85	3.2 x 1.6 x 1.1	11 x 6.25	80 x 37	
		W3043		-12	4	-	70	-	3.2 x 1.6 x 1.1	5.60 x 20	37 x 20	Small PCB size
	W3092	-6	2	0	60	43	2 x 1.2 x 0.55	8 x 2.5	110 x 55	small antenna size		
	W3004	5150-5950	-10	3.2	-	71	-	3.2x1.6x1.1	5.25 x 4.25	80 x 37		
	HELICAL	W3108	2400-2483.5	-8	1.5	-	50	-	5.0 x 2.5 x 5.5	7.50 x 5.50	100 x 40	Vertical SMD @ Corner
	DIRECT PCB	W3716		-14	4.9	4	79	71	21.5 x 9.5 x 1.6	25 x 3.2	100 x 40	@ edge near corner Two suggested antenna locations
	STAMP METAL	W3317	2400-2500	-13	4.3	3.6	81	75	22.2 x 2 x 6.25	5.8 x 6.24	100 x 100	
		W3613		-13	4.1	3.7	70	59	10 x 10 x 3.20 (14.2 x 13.3 x 3.2)	No need	80 x 50	Corner, on ground solution
		W3713	4900-6000	-10	4.6	2.6	88	43	9 x 2.4 x 0.2	16.50 x 2.90	76.20 x 76.20	Corner W3714 is a mirrored design of W3713
W3714		-10	4.6	2.6	88	43	(10.5 x 3.2 x 2.4)					
CERAMIC PATCH (PIN)	W3229	2400-2500	-7	6.5	4	90	80	25 x 25 x 4	-	70 x 70	RHCP;AR<3dB	
	W3230	-4	6	1.5	90	50	18 x 18 x 4	-	70 x 70			
DUAL WIFI	CERAMIC CHIP	W3006	2400-2483.5	-8	3.2	2.7	70	65	10 x 3.2 x 1.5	11.60 x 6.00	80 x 37	
			5150-5850	-10	4.2	3.0	80	70				
		W3078	2400-2483.5	-10	1.7	1.0	65	55	3.2 x 1.6 x 1.1	11.15 x 6.40	80 x 37	@ Corner
			4950-5850	-6	4.3	3.7	80	55				
	W3079	2400-2483.5	-13	2.5	1.3	72	60	3.2 x 1.6 x 1.1	11 x 6	80 x 37	Center	
		4950-5850	-8	5.7	3.3	78	55					
	DIRECGT PCB	W3712	2400-2500	-10	5.2	4.4	73	66	19.8 x 18 x 1.6	15 x 3.5	179 x 119	@ edge near corner Two suggested antenna locations
			4900-5950	-10	7.5	5.8	88	74				
STAMP METAL	W3715	2400-2500	-13	3.5	5.5	88	75	11 x 4.5 x 16	No need	180 x 120	Center, SMT capable No requirement of GC-area on the bottom layer	
		4900-6000	-11	5.2	2.7	95	65					
COMBO GPS + WIFI OR ISM 868/915 + WIFI	CERAMIC CHIP	W3056	2400-2483.5	-8	3.2	2.5	80	70	10 x 3.2 x 1.5	10.80 x 6.25 (Notch)	100 x 40	Single feed and 2.4GHz WiFi
			1575.42 + 1.023	-10	2.5	1.5	75	65				
		W3064C	2400-2483.5	-11	-0.7	-1.7	80	70	10 x 3.2 x 1.5	10.80 x 6.40 (Divided)	96 x 45	Dual feed and 2.4GHz WiFi
			1575.42 + 1.023	-15	-	-2.0	70	60				
		W3095	2400-2483.5	-11	2.5	1.5	85	80	10 x 3.2 x 1.5	17.80 x 6.45	70 x 35	Dual feed and Dual WiFi + GPS/Glonass/Beidou
			4950-5850	-6	3.5	1.0	70	50				
		1575-1610	-10	1.5	0.8	75	60	10 x 3.2 x 2	12 x 9.5 4.6 x 3.95	120 x 50	Center, Dual feed	
	W3320	863-928	-8	1.5	0.8	67	55					
COMPOSITE	W3330	824-928	-6	0.9	0.2	67	52	25.1 x 5 x 3	40 x 8.65	128.64 x 40	Top center, Dual feed	
	2400-2483.5	-8	2.5	1.8	66	60						

* NOTE: 1. Recommended minimum GND dimensions of PIFA type and Monopole's are roughly 40x20mm and 30x20mm (or 40x11mm), respectively. Need to construct matching values to optimize antenna performance on surrounding mechanics and materials. 2. Pulse offers very unique GPS+WiFi combo antennas on

single ceramic chip (10x3.2x1.5mm). There are three different types of combo antennas. W3056 (2.4G Wifi +GPS, single feed), W3064C (2.4G WiFi+GPS, dual feed), and W3095 (2.4G and 5G Wifi +GPS/Glonass/Beidou, dual feed). 3. "Stock" Stocked parts are typically available from Pulse distribution partners immediately.

APP.	TYPE	PULSE PART NUMBER	RF PERFORMANCE								ME REQUIREMENT			NOTE
			OPERATING FREQUENCY (MHZ)	RL MIN. (DB)	RHCP GAIN (DBIC)		LINEAR GAIN (DBI)		EFFICIENCY (%) (DB)		ANTENNA DIM. (L X W X H, MM)	GC-AREA (L X W, MM)	EVALUATION BOARD SIZE (L X W, MM)	
					PEAK	BAND EDGES	PEAK	BAND EDGES	PEAK	BAND EDGES				
GPS ONLY	CERAMIC CHIP	W3000	1575.42 +- 1.023	-15	-3.9	-4.1	0.3	0	50/-3	45/-3.5	7 x 1.6 x 1.6	6 x 20	30 x 20	3 Matching components
		W3009		-12	-3.5	-3.9	0.1	-0.2	50/-3	45/-3.5		6 x 11	40 x 11	
		W3011		-11	0.2	-0.6	3	2.3	83/-0.8	70/-1.5	10 x 3.2 x 4.0	10.80 x 6.25	80 x 37	On Ground shunt 3.3pF
	PATCH	W3212		-12	0.85	0.5	3.4	3	85/-0.7	80/-1	3.2 x 1.6 x 1.1	4.00 x 4.25	80 x 37	w/o matching
		W3213		-13	-7	-	-	-	-	-	10 x 10 x 4	-	30 x 30	
		W3099		-13	-1.5	-	-	-	-	-	13 x 13 x 4	-	30 x 30	
		W3110		-14	3.5	-	-	-	-	-	25 x 25 x 4	-	70 x 70	
HELICAL	W3110	-16	-2.1	-2.4	1.3	0.7	47/-3.3	43/-3.7	5.0 x 2.5 x 5.5	7.50 x 5.50	100 x 40	Vertical SMD, @ Corner		
GPS, GLONASS, AND/OR BEIDOU	CERAMIC CHIP	W3000	1561 +- 2/ 1575.42 + 1.023/ 1602.56 + 4	-18	-0.2	-	2.4	1.5	70/-1.55	65/-1.9	7 x 1.6 x 1.6	6 x 10	80 x 37	3 Matching components, Horiz. Mount + @Corner
		W3010		-12	1	0	3	2.2	75/-1.25	70/-1.5	10 x 3.2 x 2	10.80 x 6.25	80 x 37	@ Position1 shunt 3.3pF
		W3011A		-12	1.5	0.4	3	1.8	70/-1.55	50/-3.0	10 x 3.2 x 2	10.80 x 6.25	80 x 37	@ Position2 shunt 2.2pF
	PATCH (PIN)	W3062A		-16	1	-0.4	3.7	2.5	88/-0.6	70/-1.5	3.2 x 1.6 x 1.1	4.00 x 6.25	80 x 37	Shunt 1.8pF
		W3207		-10	0	-0.5	2.5	2.0	80/-1	60/-2.1	7 x 1.6 x 1.6	7.80 x 5.25	80 x 37	Shunt 2.2pF
		W3216		-4	2.1	0.9	-	-	-	-	25 x 25 x 4	-	70 x 70	
		W3223		-7	-2	-	-	-	60	50	13 x 13 x 5	-	50 x 50	
	PATCH (SMD)	W3224		-10	4	3.5	-	-	97/-0.2	93/-0.6	25 x 25 x 4	-	70 x 70	TS 16949
		W3225		-10	2.5	2.0	-	-	95/-0.5	79/-2	18 x 18 x 4	-	70 x 70	SMD
		W3225		-10	3	-	-	-	96/-0.3	92/-0.7	25 x 25 x 4	-	70 x 70	SMD
IRIDIUM	PATCH (PIN)	W3228	1621 +- 4	-15	4.8	4.3	-	-	84	80	25 x 25 x 4	-	60 x 60	Iridium certified, AR < 2
IRIDIUM/GNSS		W3227	1559-1660	-10	4.2	0.0	-	-	91	70	40 x 40 x 6.6	-	63 x 63	Iridium certified, VSWR < 3.5 @ 1532-1709MHz
WIFI AND GPS COMBO	CERAMIC CHIP	W3056	2400-2483.5	-8	-	-	3.2	2.5	80	70	10 x 3.2 x 1.5	10.80 x 6.25 (Notch)	100 x 40	Single feed and 2.4GHz+GPS
			1575.42 +- 1.023	-10	-	-	2.5	1.5	75	65				
		W3064C	2400-2483.5	-11	-	-	-0.7	-1.7	80	70	10 x 3.2 x 1.5	10.80 x 6.40 (Divided)	96 x 45	Dual feed and 2.4GHz+GPS
			1575.42 +- 1.023	-15	-	-	-2.0	70	60					
		W3095	2400-2483.5	-10	-	-	2.7	1.5	85	80	10 x 3.2 x 1.5	17.80 x 6.45	80 x 50	Dual feed and Dual WiFi+GPS/Glonass
			4950-5850	-6	-	-	3.7	1.0	73	53				
			1575-1610	-8	-	-	1.7	0.7	75	62				

NOTE: 1. Recommended minimum GND dimensions of PIFA type and Monopole are roughly 40x20mm and 30x20mm (or 40x11mm), respectively. Need to construct matching values to optimize antenna performance on surrounding mechanics and materials. 2. Pulse offers very unique GPS+WiFi combo antennas on single ceramic chip (10x3.2x1.5mm). There are three different types of combo antennas. W3056 (2.4G Wifi +GPS, single feed), W3064C (2.4G WiFi+GPS, dual feed), and W3095 (2.4G and 5G Wifi +GPS/Glonass/Beidou, dual feed). 3. "Stock" Stocked parts are typically available from Pulse distribution partners immediately. 4. Recommended order of antenna selection: W3010 > W3062A > W3011A

APP.	TYPE	PULSE PART NUMBER	RF PERFORMANCE					ME REQUIREMENT			NOTE		
			FREQUENCY RANGE (MHZ)	RL MIN. (DB)	PEAK GAIN (DBI)		EFFICIENCY (%)/ (DB)		ANTENNA DIM. (LXWXH,MM)	GC-AREA (L X W,MM)		EVALUATION BOARD SIZE (L X W,MM)	
					PEAK	BAND EDGES	PEAK	BAND EDGES					
LTE	COMPOSITE	W3796	698-960	-6	1.5 (AVG. PEAK GAIN)		65 (AVG.)		40 X 7 X 3	40.6 X 15	120 X 40.6	- Top mount: Horizontal - Matching: SE3.3nH+SH0.7pF; SH6.8nH	
			1427.9-1660.9	-5.5	2 (AVG. PEAK GAIN)		55 (AVG.)						
			1695-2200	-6	5.5 (AVG. PEAK GAIN)		75 (AVG.)						
			2300-2700	-6	5 (AVG. PEAK GAIN)		70 (AVG.)						
PENTA BAND		W3544A	824-960	-3.7	0.5	1.8	65	44	7.65 X 26 X 3	21 X 33.5 (W3544A)	110 X 50	1. Corner mount (vertical). 2.matching: *SE12nH - W3544AH (different packaging orientation)	
			1710-1880	-4.6	2.9	2.3	74	45					
			1850-1990	-8.6	2.4	1.7	74	64					
		W3544B	1920-2170	-5.6	2.2	1.1	68	60	7.65 X 26 X 3	50 X 18 (W3544B)	110 X 50	1. Top mount (Horizontal) 2.matching: 10nH	
			824-960	-6.5	1	-0.7	70	53					
			1710-1880	-5.7	2.7	1.7	77	59					
QUAD BAND (US)		CERAMIC	W3073	824-894	-4.7	0.4	-2.6	51	28	10 X 3.2 X 4	40 X 10	105 X 40	1. Matching: SE10nH+SE12nH+SH12nH. 2.Tuning strip on PCB.
				1710-1880	-3.5	2.3	0.7	59	40				
	1850-1990			-5.9	2.5	1.6	59	54					
	QUAD BAND (EU)		W3073	1920-2170	-3.3	2.2	0.9	58	46	10 X 3.2 X 4	40 X 10	105 X 40	1. Matching: *SE10nH+*SE10nH+*SH15nH. 2.Tuning strip on PCB.
880-960				-3.8	1	-1.8	60	34					
1710-1880				-4.9	2.9	2	70	54					
DUAL BAND (EU)			W3070	1850-1990	-8	2.9	2.5	71	62	10 X 3.2 X 2	40 X 10	95 X 40	Matching: *SE18nH+ *SE10nH
	1920-2170			-4.4	2.8	2.3	67	59					
	880-960			-5.1	1.2	-0.4	65	47					
ULTRA WIDEBAND ANTENNA FOR WIRELESS SENSOR SOLUTIONS													
UWB (WIRELESS SENSOR)	CERAMIC		W3340	6000-8500	-9	2 (AVG. PEAK GAIN)		65 (AVG.)		3.2 X 1.6 X 1.1	4.6 X 7	40 X 20	CORNER MOUNT
	COMPOSITE		W3540	2700-8200	-10	5.89	-	80 (AVG.)		10.6 X 12.5 X 0.8	13.75 X 20.15	100 X 50	CORNER MOUNT

NOTE: 1. "Stock" Stocked parts are typically available from Pulse distribution partners immediately. 2. * SE = Series and *SH = Shunt

APP.	TYPE	PULSE PART NUMBER	RF PERFORMANCE						ME REQUIREMENT				NOTE
			OPERATING FREQUENCY (MHZ)	RL MIN. (DB)	PEAK GAIN (DBI)		EFFICIENCY (%)		ANTENNA DIM. (LXWX-H,MM)	CABLE LENGTH FROM EDGE/ DIAMETER, MM	CONNECTOR TYPE	CABLE ALIGNMENT W/ ANTENNA	
					MAX.	MIN.	MAX.	MIN.					
ISM	FPC	W3312B0100	860-930	-8	2.3	-	50 (Avg.)		75 x 15	L:100 / D:1.13	U.FL compatible	PERP	Alternative: W3502, W3538 , W3501
ISM + WIFI COMBO	PCB	W3332B0150	863-928	-5	0.2	-	55 (Avg.)		82 x 15 x 0.56	L:150 / D:1.13	U.FL compatible	PERP	ISM 868/915 and 2.4GHz WiFi (two feed cables). Isolation: <-11dB.
			2400-2500	-10	4.1	-	64 (Avg.)						
GNSS	FPC	W3908B0100	1560-1610	-12	0.3	-0.2	36	33	20 x 26.80 x 0.1	L:93 / D:1.13	U.FL compatible	PAR.	
WIFI, BT, ZIGBEE	PCB	W3525B039	2400-2483.5	-10	2	0.6	65	55	48 x 11 x 0.8	L:100 / D:1.13	U.FL compatible	PERP	w/ adhesive: W3525BTWxxx
		W3593B0100	4900-5850	-10	2	0.5	70	50	45 x 7 x 0.8	L:100 / D:1.13	U.FL compatible	PERP	No adhesive
		W3513	2400-2500; 4900-5850	-13; -10	2;2.7	1.4; 0.4	70; 67	68; 52	16 x 70 x 0.9	L:212 / D:1.13	U.FL compatible	PAR.	No adhesive
	FPC	W3919B0050	4900-5925	-10	3.7	2.5	72	50	15.9 x 7.6 x 0.45	L: 50 / D: 1.13	U.FL compatible	PERP	W3919XXXXX (for custom cable length)
		W3921B0100	2400-2500	-13	1.8	1	57	50	33 x 7.7 x 0.1	L: 100/ D:1.13	U.FL compatible	PERP	W3921XXXXX (for custom cable length)
		W3920B0050	4900-5925	-10	3.7	2.2	75	55	12.5 x 7.6 x 0.15	L: 50 / D: 1.13	U.FL compatible	PERP	W3920XXXXX (for custom cable length)
		W3315BA0100 (W3315B0100MHF1)	2400-2500	-10	2	1	75	65	45 x 6 x 0.1	L:100 / D:1.13	U.FL compatible	PAR.	W3315B0100 (MHF-A13 or equivalent) W3315BC0100 (MHFIII 20367 or equivalent)) W3315BD0100 (MHF4 or equivalent)
		4900-5875	-10	5.5	4	85	62						
		W3334B0150	2400-2500	-10	4.8	3.4	53	49	14 x 5 x 0.1	L:150 / D:1.13	U.FL compatible	PAR.	W3334XXXXX (for custom cable length)
		W3917B0050	2400-2500	-10	2.7	1.8	62	53	42.6 x 8.6 x 0.15	L:50 / D:1.13	U.FL compatible	PAR.	W3917XXXX (for custom cable length)
W3918B0050	4900-5925	-10	3.8	3.4	73	60	35.2 x 8.5 x 0.15	L:50 / D:1.13	U.FL compatible	PERP	W3918XXXX (for custom cable length)		
		-10	5.3	3.3	90	70							
MIMO WIFI	FPC	W6102B0100	2400-2500	-10	isolation: -20	2 (Avg.)	45 (Avg.)		50 x 20 x 0.1	L:100 / D:1.13	U.FL compatible	PERP	Two cables
		4900-5900	-10	isolation: -20	5 (Avg.)	75 (Avg.)							
		W6103B0100	2400-2500	-10	isolation: -15	4.5 (Avg.)	70 (Avg.)		80 x 20 x 0.1	L:100 / D:1.13	U.FL compatible	PERP	Three cables
4900-5900	-10	isolation: -15	5 (Avg.)	75 (Avg.)									
3G	PCB	W3502B0020	824-960; 1710-1990	-6; -4	2; 2.4	0.8; -0.4	78; 80	55; 70	43 x 17 x 0.5	L:20 / D:1.13	U.FL compatible	PERP	80mm ground plane with 5mm gap
	W3538B0200	824-960; 1710-2170	-6; -6	-	-	57; 71	41; 50	40 x 15 x 0.7	L:200 / D:1.13	U.FL compatible	PERP	W3538XXXX	
3G + GNSS COMBO	FPC	W3501B0140	824-960; 1710-1990	-7; -8	1.5; 4.2	0.8; 2.8	61; 71	50; 50	87 x 25 x 0.2	L:140 / D:1.13	U.FL compatible	PERP	W/ adhesive: W3571B0140.
			W3915	880-960; 1710-2170	-6; -8	3; 3.5	1; 2.8	73; 87	51; 75	74 x 19 x 0.2	L:100/ D:1.13	U.FL compatible	PERP
1565-1605	-6	2	0.5	68	55								
4G (LTE)	FPC	W3554B0140	698-960; 1710-2690	-5; -8	1.5; 3.9	-0.6; 1.9	75; 86	50; 65	120 x 30 x 0.2	L:140 / D:1.13	U.FL compatible	PERP	W/ adhesive: W3554B0140T
		W3907B0100	698-960; 1427-1610	-8; -7	2.2; 1.8	-0.5; 0	70; 65	50;50	115.7 x 20 x 0.1	L:100 / D:1.13	U.FL compatible	PERP	
			1695-2700; 3400-3600	-7; -10	3.5; 4	1; 2.5	72; 80	52; 78					
W3929B0100	617-960; 1710-2690; 3400-3900	-6	1;4.2;3.2	-1;1.5;2	72;77;75	48;53;54	115.8 x 30.4 x 0.1	L: 100/ D:1.13	U.FL compatible	PERP			
4G + GNSS COMBO	FPC	W3906B0100	698-960; 1427-1610	-13; -8	2.6; 2.2	-0.6; 1.2	70; 60	50;50	120.4 x 26.8 x 0.1	L:100 / D:1.13	U.FL compatible	PERP	Two cables
			1695-2700; 3400-3600	-7; -10	3.6; 4	1.8; 3.5	76; 85	52; 80					
1550-1625	-10	2	0.5	37	30								
MIMO 4G (LTE)	FPC	W6112B0100	698-960; 1428-2170	-6; -7.5	isolation: -10; -15	4.3; 3.8 (Avg)	55; 68 (Avg.)		224 x 20 x 0.1	L:100 / D:1.13	U.FL compatible	PERP	Two cables
			2300-3600	-10	isolation: -15	4 (Avg.)	65 (Avg.)						
MIMO 4G + GNSS COMBO	FPC	W6113B0100	698-960; 1428-2200	-6; -7.5	isolation: -10; -13	2.9; 1.7; 3.4	55; 60; 65 (Avg.)		224 x 20 x 0.1	L:100 / D:1.13	U.FL compatible	PERP	Three cables. Cable 1 : LTE Main; Cable 2:GNSS; Cable 3: LTE MIMO
			2300-3600	-7.5	isolation: -13	3.8; 4.2	70; 65 (Avg.)						
			1570-1610	-10	isolation: -13	0.8	35 (Avg.)						

Note: 1. FPC antenna is measured on the 2mm ABS/PC plate. 2.Default Connector: Equivalent of I-PEX MHF 20278-11R-13 or compatible with U.FL connector. 3. Default Receptacle: Equivalent of I-PEX MHF 20279-001E (3pad), 20441-001E-01(4pad) or compatible with U.FL receptacles. 4.Cable length is a distance between the edge of PCB and the center of connector.6.

Contact sales for custom cable lengths and connector type. Email: antennas.us@pulseelectronics.com. Phone: 800-ANTENNA (268-3662) or 360-944-7551.



APP.	TYPE	PULSE PART NUMBER	RF PERFORMANCE							ME REQUIREMENT				NOTE
			OPERATING FREQUENCY (MHZ)	ANTENNA ELEMENT		LNA			ANTENNA DIMENSION (MM)	OVERALL DIMENSION (MM)	CONNECTOR TYPE	COAXIAL CABLE (LENGTH; DIAMETER)		
				VSWR	RHCP GAIN (DBIC)	GAIN (DB)	NF (DB)	CURRENT (MA)					VCC (VDC)	
GPS	CERAMIC PATCH WITH LNA AND COAXIAL CABLE	GPSMOD1315	1575.42 +/- 1.023	1.5 : 1	-1 + 1	16 + 1	< 2.4	< 6	3.3-5 + 0.5	13x13x5	14x15x8.15	U.FL compatible	L:32; D:0.81	1 stage LNA
		GPSMOD1333		1.5 : 1	-1 + 1	33 + 2	< 2.4	< 10	3.3-5 + 0.5	13x13x5	16x17x8.15	U.FL compatible	L:32; D:0.81	2 stage LNA
	CERAMIC PATCH WITH LNA	GPSMOD2515		1.5 : 1	3.4 + 1	16 + 1	< 2.6	< 6	3.3-5 + 0.5	25x25x4	30x30x8	N/A	N/A (Solder pad for coaxial cable)	1 stage LNA
		GPSMOD2533		1.5 : 1	3.4 + 1	33 + 2	< 3.4	< 10	3.3-5 + 0.5	25x25x4	30x30x8	N/A	N/A (Solder pad for coaxial cable)	2 stage LNA
GNSS (GPS, GLONASS, BEIDOU, AND GALILEO)	CERAMIC PATCH WITH LNA AND COAXIAL CABLE	GPSGB1315	1561 +/- 2.046, 1575.42 +/- 1.023, and 1602.5625 +/- 4 MHz	2 : 1	-1 + 1	15 + 2	< 2.4	< 6	3.3-5 + 0.5	13x13x5	14x15x8.15	Equivalent of I-PEX MHF 20278-11R-13 or compatible with U.FL connector	L:100; D:1.13	1 stage LNA
		GPSGB1330		2 : 1	-1 + 1	30 + 2	< 2.4	< 6	3.3-5 + 0.5	13x13x5	16x17x8.15		L:100; D:1.13	2 stage LNA
		GPSGB2515		2 : 1	1 + 1	15 + 2	< 2.4	< 6	3.3-5 + 0.5	25x25x4	30x30x8		L:100; D:1.13	1 stage LNA
		GPSGB2530		2 : 1	1 + 1	30 + 2	< 2.4	< 6	3.3-5 + 0.5	25x25x4	30x30x8		L:100; D:1.13	2 stage LNA

Note: Spec of 'Out of band rejection' for LNA can be found on the datasheet (GPSGBXXXX). For more questions, please contact to sales (antennas.us@pulseelectronics.com).



APP.	TYPE	PULSE PART NUMBER	RF PERFORMANCE								MECHANICAL REQUIREMENT		NOTE
			FREQUENCY (MHZ)	WITH MATCHING NETWORK			WITHOUT MATCHING NETWORK (BARE COIL)				PACKAGE TYPE	DIMENSION (IN/MM)	
				READING DISTANCE EMVCO (MM)	READING DISTANCE GRID SCAN (AVG.,MM)	IMPEDANCE (OHM)	SELF RESONANT FREQUENCY (MHZ)	INDUCTANCE (UH)	RESISTANCE (OHM)	Q-FACTOR			
NFC	FLEX ONLY	W7001	13.56	40	33	50/80	100	0.9	1.55	49	A	0.98 x 0.98 x 0.005 (25 x 25 x 0.12)	Without a ground plane near antenna
	FLEX WITH FERRITE & COAXIAL CABLE	W3509	13.56	40	28	50/80	42	1.6	3.60	37.8	G	1.38 x 1.97 x 0.012 (35 x 50 x 0.30)	On ground plane solution. w/ 90mm 1.13OD coaxial cable and U.FL compatible connector
	FLEX WITH FERRITE	W3579	13.56	40	28	50/80	42	1.6	3.60	37.8	B	1.38 x 1.97 x 0.012 (35 x 50 x 0.30)	On ground plane (metal objects like battery) solution
		W7013	13.56	20	25	50/80	71.5	1.05	2.70	33	C	1.18 x 0.98 x 0.014 (30 x 25 x 0.36)	
	FLEX WITH TWISTED PAIR CABLE + CONNECTOR	W7000	13.56	-	36	50	75.5	1.27	2.20	49	F	1.69 x 1.34 x 0.005 (43x 34 x 0.11)	Adhesive tape under coil included
	WIRE LOOP ON PLASTIC CARRIER	W7002	13.56	40	35	50/80	89	0.65	0.95	57	D	3.72 x 2.24 x 0.14 (94.6 x 56.8 x 3.65)	Optimized for metal proximity within the device
WIFI AND NFC COMBO	TRACE ON PCB	W5100	13.56	-	-	50	65.9	0.95	-	44	E	1.57 x 1.57 x 0.05 (40 x 40 x 1.2)	Test setup over 80x80 mm metal GP
			2400-2483.5	RL Min. (dB): -8		Peak Gain in free space: -1dBi		Peak Gain on Metal: 1dBi		-			
		W5101	13.56	-	-	50	57.6	1.13	-	46	E	1.77 x 1.77 x 0.05 (45 x 45 x 1.2)	Test setup over 80x80 mm metal GP
			2400-2483.5	RL Min. (dB): -8		Peak Gain in free space: 0.5dBi		Peak Gain on Metal: 1.5dBi		-			

NOTE: 1. Wire assembly option: Picoblade connector with wire. 2. "Stock" Stocked parts are typically available from Pulse distribution partners immediately.



APP.	TYPE	PULSE PART NUMBER	RF PERFORMANCE			MECHANICAL REQUIREMENT					NOTE
			FREQUENCY RANGE (MHZ)	RL MIN. (DB)	PEAK GAIN (DBI)	HEIGHT (MM)	DIAMETER (MM)	PACKAGE TYPE	CONNECTOR	IP-RATE	
						STRAIGHT (BENT)	MAX (MIN)				
ISM	Stick/ no Swivel	W1087	779-787	-10	1.5	179	10	A	SMA(m)	IP65	
	Stick/Swivel	W1063	868-928	-8	3	195 (172)	13 (6)	B	RP-SMA		W1063M (SMA) W1063V (NM)
	Stick/ no Swivel	W5017		-8	2	179	10	A	SMA (m)		W5012(RP-SMA)
		W5021		-8	2	171	10	G	RP-SMA (Right angle)		
WiFi (2.4GHz)	Stick/Swivel	W1010	2400-2500	-10	2	108 (86)	10 (7.8)	B	SMA(m)		W1030W (White)
		W1030		-10	2	108 (86)	10 (7.8)	B	RP-SMA		
		W1027		-11	3.2	136 (110)	10 (6)	C	RP-SMA		
		W1038		-10	3.8	197 (170)	13.2 (7.4)	C	RP-SMA		W1038W (White) W1038G (Grey)
	Stick/ no Swivel	W1059		-10	5	195 (172)	13 (6)	C	SMA (m)		
		W5001		-10	1.5	128	10 (6)	G	RP-SMA (Right angle)	IP65	
		W5010		-10	1.5	130	10 (6)	A	RP-SMA		W5011 (SMA)
		W5039		-10	1.3	94	10 (6)	F	RP-SMA	IP67	
		W1095		-7.5	1	50	8	F	SMA		W1095K (RA - SMA)
WiFi (5GHz)	Stick/Swivel	W1028B	5150-5850	-9	2	136 (114)	9.2 (6)	C	RP-SMA		
Dual WiFi (2.4/5GHz)	Blade/ Swivel	W1043	2400-2500; 5150-5850	-10	2	157 (130)	17.6 (13)	E	RP-SMA		W1044 (SMA)
		SPDA17RP2400/5900	2400-2500; 4900-5900	-10	0.8; 5.9	175 (150)	21.8 (13.7)	H	RP-TNC		
		W5098		-10	1.7; 3.5	150 (120)	13 (6)	C	RP-SMA	IP67	W5097 (SMA)
	Stick/ no Swivel	W5028	2400-2500; 5150-5850	-10	1.9; 5.5	128	10 (6)	G	RP-SMA (Right angle)	IP65	W5028RPG (Stright, RP-SMA)
		W5029	2400-2500; 5150-5925	-10	2.3; 5	78	7.9	G	RP-SMA (Right angle)	IP65	W5029RPG (Stright, RP-SMA)
2G	Blade/ Swivel	SPDA24850/1900	824-894; 1850-1990	-7.5	0; 1.5	176 (147)	21.8 (13.7)	H	SMA (m)		
		SPDA17850/1900		-10	0; 1.2	176 (147)	21.8 (13.7)	H	TNC		
3G	Stick/ no Swivel	W1900	824-960; 1710-2170	-4;-6	1; 2	49	8	D	SMA (m) (Right angle)		W1902(RP-SMA)
		W1900-M		-4;-6	1; 2	52	11.4 (8)	D	SMA (m) (Right angle)	IP65	
		W1910		-4;-6	1; 2	49	10 (8)	F1	SMA (m)		W1911(RP-SMA)
		W1910-M		-4;-6	1; 2	50	12 (8.5)	F2	SMA (m)	IP65	
	Blade/ Swivel	SPDA17806/2170LAR	806-960; 1710-2170	-7.5	0.5; 0.5	192 (159)	23.8 (15.7)	H	TNC		Medium Grey
4G	Blade/ Swivel	SPDA24700/2700	698-960; 1710-2170; 2500-2700	-7.5	0.6; 1.5; 3.4	223 (192)	23.8 (15.6)	H	SMA (m)		
		W5095X	698-960; 1447-1510; 1710-2170; 2500-2700	-7.5	1.5; 2.5	229 (198)	29 (15.5)	H	SMA (m): W5095K TNC: W5095	IP65	
		W5084X	698-960; 1440-2690; 3400-3700	-6	2.0; 4.0; 5.0	229 (198)	44 (15.5)	H	SMA (m): W5084K TNC: W5084	IP65	
		SPDA24617/3700	617-960; 1710-2700; 3550-3800	-5	2.5; 1.5; 3	224 (198)	37 (15.5)	H	SMA (m)	IP65	
	Stick/ no Swivel	W1096	698-960; 1710-2690; 3400-3800	-5;-10;-4	-0.5; 4; -0.5	106	10.5	G	RP-SMA (Right angle)	IP65	



STYLE	APP.	ANTENNA TYPE	PULSE PART NO.	RF PERFORMANCE				ME REQUIREMENT					NOTE	
				FREQUENCY RANGE (MHZ)	RL, MIN. (DB)	GAIN, PEAK (DBI)	EFFICIENCY, AVG. (%)	ANTENNA DIM. (L X W X H, MM)	GC-AREA (L X W,MM)	BOARD SIZE (L X W,MM)	CABLE TYPE, LENGTH (MM)	CONNECTOR TYPE		
Embedded (SMD)	Single WiFi, BT, Zigbee	Ceramic chip	W3092	2400-2483.5	-6	2	52	2 x 1.2 x 0.55	8 x 2.5	110 x 55	-	-		
	Penta Band	Composite	W3544A	824-960	-3.7	0.5	1.8	65	44	7.65 x 26 x 3	21 x 33.5 (W3544A)	110 x 50	@ corner (Vertical)	
				1710-1880	-4.6	2.9	2.3	74	45					
				1850-1990	-8.6	2.4	1.7	74	64					
				1920-2170	-5.6	2.2	1.1	68	60					
			W3544B	824-960	-6.5	1	-0.7	70	53	7.65 x 26 x 3	50 x 18 (W3544B)	110 x 50		@ top center
				ç1710-1880	-5.7	2.7	1.7	77	59					
				1850-1990	-9.3	2	1	77	69					
	LTE		W3796	698-960	-6	1.5 (Avg. peak gain)		65 (Avg.)		40 x 7 x 3	40.6 x 15	120 x 40.6	@ top center	
				1427.9-1660.9	-5.5	2 (Avg. peak gain)		55 (Avg.)						
				1695-2200	-6	5.5 (Avg. peak gain)		75 (Avg.)						
				2300-2700	-6	5 (Avg. peak gain)		70 (Avg.)						
	STYLE	APP.	TYPE	PULSE PART NO.	FREQUENCY RANGE (MHZ)	RL, MIN. (DB)	GAIN, PEAK (DBI)	EFFICIENCY, AVG. (%)	ANTENNA DIM. (L X W X H,MM)	GC-AREA (L X W,MM)	BOARD SIZE (L X W,MM)	CABLE TYPE, LENGTH (MM)	CONNECTOR TYPE	NOTE
External	ISM 868	Stealth Blade	W8000	806-896	-10	0	80	125 x 17 x 3	-	-	RG174; L: 102	Fakra, Code Z	IP65	
	ISM 915		W8011	890-960	-10	0	80	125 x 17 x 3	-	-	RG174; L: 1100	Fakra, Code Z	IP65	
	LTE		W6100	698-960; 1710-2700	-7	3; 4	65; 60	109 x 26 x 2	-	-	RG316; L: 550	Fakra, Code D		
			W6101	698-960; 1710-2700	-7	3; 4.5	65; 55	106 x 26 x 1	-	-	RG316; L: 550	Fakra, Code D		

Note: Contact Us for AEC-Q200 Certification Details. AEC-Q200 certification are only applicable for embedded solution.

STYLE	APP.	TYPE	PULSE PART NUMBER	RF PERFORMANCE						ME REQUIREMENT			NOTE
				FREQUENCY RANGE (MHZ)	RL MIN. (DB)	PEAK GAIN (DBI)		EFFICIENCY (%)		ANTENNA DIM. (LXWXH,MM)	GC-AREA (L X W,MM)	EVALUATION BOARD SIZE (L X W,MM)	
						PEAK	BAND EDGES	PEAK	BAND EDGES				
EMBEDDED (SMD)	ISM 433	CERAMIC CHIP	W3015L	433 +/- 1	-10	-2.5	-	35	-	10 x 3.2 x 4.0	10.80 x 14	200 x 37	@ center edge
	ISM 868 (867-870)		W3000	868-870	-15	-1.4	-1.5	30	29	7 x 1.6 x 1.6	20 x 9.50	40 x 20	@ top center
			W3013	868-870	-11	1.5	1.4	65	64	10 x 3.2 x 4.0	10.80 x 8.25	80 x 37	@ center edge
	ISM 915 (902-928)		W3016	868-870	-19	-2.2	-2.5	25	23	10 x 3.2 x 4.0	11.50 x 7	25 x 25	@ corner
			W3012	902-928	-6	2	0.5	70	50	10 x 3.2 x 4	10.80 x 8.25	100 x 37	@ center edge
	SINGLE WIFI, BT, ZIGBEE		W3014	880-960	-7	-0.5		45	40	10 x 3.2 x 1.5	40 x 16	96 x 40	@ top center
			W3000	2400-2483.5	-18	2.5	2.1	65	55	7 x 1.6 x 1.6	6.00 x 11.00	40 x11	
			W3001		-6	1.5	0.5	75	60	10 x 3.2 x 4.0	10.80 x 6.25	80 x 37	On Ground
			W3008		-8	1.7	0.7	70	55	3.2 x 1.6 x 1.1	4.00 x 4.25	80 x 37	
			W3008C		-11	2.2	1.9	75	70	3.2 x 1.6 x 1.1	4.00 x 6.25	80 x 37	
	W3043		-12		4	-	70	-	3.2 x 1.6 x 1.1	5.60 x 20	37 x 20	Small PCB	
	DUAL WIFI		W3006	2400-2483.5	-8	3.2	2.7	70	65	10 x 3.2 x 1.5	11.60 x 6.00	80 x 37	
				5150-5850	-10	4.2	3.0	80	70				
			W3078	2400-2483.5	-10	1.7	1.0	65	55	3.2 x 1.6 x 1.1	11.15 x 6.40	80 x 37	@ Corner
				4950-5850	-6	4.3	3.7	80	55				
	W3079		2400-2483.5	-13	2.5	1.3	72	60	3.2 x 1.6 x 1.1	11 x 6	80 x 37	@ center edge	
			4950-5850	-8	5.7	3.3	78	55					
	COMBO ISM 868/915 + WIFI OR GPS/ GLONASS+ WIFI		W3320	863-928	-8	1.5	0.8	67	55	10 x 3.2 x 2	12 x 9.5	120 x 50	@ center edge
				2400-2500	-6	3.4	1.4	61	45		4.6 x 3.95		
			W3056	2400-2483.5	-8	3.2	2.5	80	70	10 x 3.2 x 1.5	10.80 x 6.25	100 x 40	Single feed
				1575.42 + 1.023	-10	2.5	1.5	75	65		(Notch)		
	W3064C		2400-2483.5	-11	-0.7	-1.7	80	70	10 x 3.2 x 1.5	10.80 x 6.40	96 x 45	Dual feed	
			1575.42 + 1.023	-15		-2.0	70	60		(Divided)			
	W3095		2400-2483.5	-11	2.5	1.5	85	80	10 x 3.2 x 1.5	17.80 x 6.45	70 x 35	Dual feed	
			4950-5850	-6	3.5	1.0	70	50					
			1575-1610	-10	1.5	0.8	75	60					
	QUAD BAND (US)		W3073	824-894	-4.7	0.4	-2.6	51	28	10 x 3.2 x 4	40 x 10	105 x 40	
				1710-1880	-3.5	2.3	0.7	59	40				
1850-1990		-5.9		2.5	1.6	59	54						
1920-2170		-3.3		2.2	0.9	58	46						
QUAD BAND (EU)	W3073	880-960	-3.8	1	-1.8	60	34	10 x 3.2 x 4	40 x 10	105 x 40			
		1710-1880	-4.9	2.9	2	70	54						
		1850-1990	-8	2.9	2.5	71	62						
		1920-2170	-4.4	2.8	2.3	67	59						

STYLE	APP.	TYPE	PULSE PART NUMBER	RF PERFORMANCE						ME REQUIREMENT			
				OPERATING FREQUENCY (MHZ)	RL MIN. (DB)	RHCP GAIN (DBIC)		LINEAR GAIN (DBI)		EFFICIENCY (%)/(DB)		ANT. DIM. (LXWXH,MM)	GC-AREA (L X W,MM)
						PEAK	BAND EDGES	PEAK	BAND EDGES	PEAK	BAND EDGES		
EMBEDDED (SMD)	GPS ONLY	CERAMIC CHIP	W3000	1575.42 + 1.023	-15	-3.9	-4.1	0.3	0	50/-3	45/-3.5	7 x 1.6 x 1.6	6 x 20
					-12	-3.5	-3.9	0.1	-0.2	50/-3	45/-3.5		6 x 11
			W3009		-11	0.2	-0.6	3	2.3	83/-0.8	70/-1.5	10 x 3.2 x 4.0	10.80 x 6.25
	GPS/ GLONASS	CERAMIC PATCH	W3011	-12	0.85	0.5	3.4	3	85/-0.7	80/-1	3.2 x 1.6 x 1.1	4.00 x 4.25	
			W3224	1575.42 + 1.023/	-10	2.5	88	18 x 18 x 4	-	70 x 70	-	-	
	W3225	1602.56 + 4	-10	3	96	25 x 25 x 4	-	70 x 70	-	-			
	GPS, GLONASS, AND/ OR BEIDOU	CERAMIC CHIP	W3000	1561 + 2/ 1575.42 + 1.023/ 1602.56 + 4	-18	-0.2		2.4	1.5	70/-1.55	65/-1.9	7 x 1.6 x 1.6	6 x 10
			W3010		-12	1	0	3	2.2	75/-1.25	70/-1.5	10 x 3.2 x 2	10.80 x 6.25
					-12	1.5	0.4	3	1.8	70/-1.55	50/-3.0		
			W3011A		-16	1	-0.4	3.7	2.5	88/-0.6	70/-1.5	3.2 x 1.6 x 1.1	4.00 x 6.25
W3062A			-10		0	-0.5	2.5	2.0	80/-1	60/-2.1	7 x 1.6 x 1.6	7.80 x 5.25	



*MADE IN THE USA

STEALTH BLADES

Stealth Blade Antennas have the following specifications:

Gain: 2.14dBi

Maximum Power : 3 Watts

Polarization :Linear



Model	Frequency (MHz)	Bandwidth % @1.5/2.1	Dimensions L x W (In)	Coax	Connector
SB698SMA3	698-960/1710-2170/2300-2700	50/60	4.2 x 1	3' RG-316	SMA
SB698SMA12	698-960/1710-2170/2300-2700	50/60	4.2 x 1	12' RG-316	SMA
*SB8003	806-896	67/90	5.2 x .75	3' RG-174	No Conn
*SB80012	806-896		5.2 x .75	12' RG-174	No Conn
*SB800FME3	806-896		5.2 x .75	3' RG-174	FME
*SB800FME12	806-896		5.2 x .75	12' RG-174	FME
*SB800MPL3	806-896		5.2 x .75	3' RG-174	MPL
*SB800MPL12	806-896		5.2 x .75	12' RG-174	MPL
*SB800SMA3	806-895		5.2 x .74	3' RG-174	SMA
*SB800TNC3	806-896		5.2 x .75	3' RG-174	TNC
*SB800TNC12	806-896		5.2 x .75	12' RG-174	TNC
*SB9003	890-960	55/70	5.2 x .75	3' RG-174	No Conn
*SB90012	890-960	55/70	5.2 x .75	12' RG-174	No Conn
*SB900SMA3	890-960	55/70	5.2 x .75	3' RG-174	SMA
*SB900SMA12	890-960	55/70	5.2 x .75	12' RG-174	SMA
*R380900323	806-960/1710-1990		5 x .8	10' RG-174	FME
*R3809003324	806-960/1710-1990		5 x .8	10' RG-174	SMA
*SB450FME3	450-470	20/30	10 x .75	3' RG-174	FME
*SB450FME12	450-470	20/30	11 x .75	12' RG-174	FME
*SB24003	2400-2500	60/150	3 x .75	3' RG-174	No Conn
*SB24006	2400-2500	60/150	3 x .75	6' RG-174	No Conn
*SB2400SMA3	2400-2500	60/150	3 x .75	3' RG-174	SMA
*SB2400SMA6	2400-2500	60/150	3 x .75	6' RG-174	SMA
*SB2400SMB3	2400-2500	60/150	3 x .75	3' RG-174	SMB
*SB2400SMB6	2400-2500	60/150	3 x .75	6' RG-174	SMB
*SB2400MMCX3	2400-2500	60/150	3 x .75	3' RG-174	MMCX
*SB2400MMCX6	2400-2500	60/150	3 x .75	6' RG-174	MMCX

SINGLE-BAND EXTERNAL ANTENNAS WITH I-PEX

Model	Frequency	Mechanical Length	Cable Length (in/min)	Connector
W1049B030	2400-2500	3.25/82.5	3/76	UFL compatible
W1049B050	2400-2500	3.25/82.5	5/127	UFL compatible
W1049B090	2400-2500	3.25/82.5	9/229	UFL compatible
W1049B120	2400-2500	3.25/82.5	12/309	UFL compatible
W1039B030	2400-2500/4900-5925	3.46/88	3/76	UFL compatible



W1049

ICE BLADE (IP67) (XXXX)



Now Available: IceBlade Transparent Antennas

- LTE Model with SMA : Pulse part : ICEBLADELS
- LTE Model with TNC : Pulse part : ICEBLADELT
- WiFi Model with SMA : Pulse part : ICEBLADEWS
- WiFi Model with TNC : Pulse part : ICEBLADEWT

See PulseAntennas website for performance data.

MIMO LTE WALL MOUNT ANTENNA

Frequencies: 700-960 / 1710-1990 / 2110-2170 / 2500-2700

Low Band Gain: 2.5 dBi Average

High Band Gain: 3.5 dBi Average

Pattern: Omni Directional

Part Number	Cable Type	Antenna Size (in/mm)	Cable Length (in/mm)	Connector
WA700/2700SMA	RG - 174	5.85 x 5 x 0.2 / 149 x 127 x 5.1	39.4 / 1000	SMA Male
WA700/2700RPSMA	RG - 174	5.85 x 5 x 0.2 / 149 x 127 x 5.1	39.4 / 1000	RP-SMA



WA700

Noted: Antenna comes with two chips and suction cups for mounting

The following chart summarizes performance, size and cost parameters for various antenna types.

ANTENNA PERFORMANCE CHART

Type	Bandwidth	Performance	Length	Connector	Frequency	Pricing
Helical Short	6%	Poor (**)	Short	All	VHF/UHF	\$\$
Helical	8%	Average (***)	Shorter	All	Low/Mid/VHF/UHF	\$\$
Helical Quarter Wave	12%	Good (***)	Longer	All except SMA	VHF	\$\$
Whip	12%	Good (***)	Mid	All	UHF	\$
End Fed Half Wave	10%	Better (****)	Longer	Coaxial	800	\$\$\$
Half Wave Dipole	10%	Best (*****)	Longer	Coaxial	800	\$\$\$\$
Wide Band	25%	Good (***)	Longer	Coaxial	All	\$\$\$\$\$
Dual Band	2x8%	Average (***)	Mid	Coaxial	VHF/UHF	\$\$

Due to the high variability of use, measurements are difficult to make on portable antennas. All Larsen portable antenna designs are tested for gain and VSWR using a standard fixture for portable antennas. Gain measurements are determined based on range or chamber measurements. Performance ratings are determined using a VSWR standard of less than 2.0:1.

Skyline Series: Dualband Portable Antenna



SMA F T2
SMA Female recessed Insulator & partial(long) skirt (SFU type)

Popular Brands Supported

Standard

PART NUMBER	FREQUENCY BAND (MHz)	ANTENNA TYPE	APPROXIMATE LENGTH
SMA Female Standard - Half Skirt Base - T3 (SFU Type)			
SLHL23365	350-380 1559-1606	Helix 1/4λ	3.5"
SLHL23375	350-400 1559-1606	Helix 1/4λ	3.5"
SLHL23415	400-430 1559-1606	Helix 1/4λ	3.5"
SLHL23435	400-470 1559-1606	Helix 1/4λ	3.5"
SLWH23415	400-430 1559-1606	Whip 1/4λ	5.8"
SLWH23435	400-470 1559-1606	Whip 1/4λ	5.8"

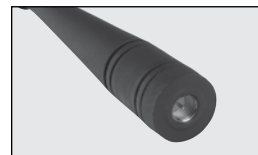

SMA MALE T2
SMA Male partial (long) skirt

Popular Brands

Standard

PART NUMBER	FREQUENCY BAND (MHz)	ANTENNA TYPE	APPROXIMATE LENGTH
SMA Male Standard - Half Skirt Base - T2			
SLHL24365	350-380 1559-1606	Helix 1/4λ	3.5"
SLHL24375	350-400 1559-1606	Helix 1/4λ	3.5"
SLHL24415	400-430 1559-1606	Helix 1/4λ	3.5"
SLHL24435	400-470 1559-1606	Helix 1/4λ	3.5"
SLWH24415	400-430 1559-1606	Whip 1/4λ	5.8"
SLWH24435	400-470 1559-1606	Whip 1/4λ	5.8"



*MADE IN THE USA

All factory tuned Kulduckies® are exact tuned to your specified frequency

* To order, replace the FREQ, UHF or VHF designation with your desired centered frequency.



KuL DUCKIE® FREQUENCY COLOR CODE

VHF FREQUENCY	COLOR	UHF FREQUENCY	COLOR
136 - 140 MHz	Blue	406 - 420 MHz	Black
142 - 149 MHz	Green	450 - 469 MHz	Black
150 - 160 MHz	Yellow	470 - 512 MHz	Black
162 - 174 MHz	Red	150 / 450 MHz	Blue

Kulduckie®

All factory tuned KuL DUCKIES® are ExacTuned to your specified frequency.

*[To order, replace the FREQ, UHF or VHF designation with your desired center frequency]

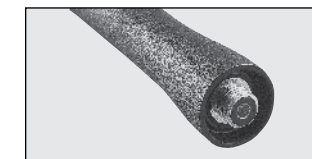

1/4-32X3/16

Male stud type mount with skirt (MX type) KD2/12

PART NUMBER	ELECTRICAL TYPE	FREQUENCY BAND	APPROX LENGTH
1/4-32x3/16			
KD2FREQHQ1*	HQ Helical 1/4 λ	136 - 140 MHz	9 1/2"
KD2FREQHQ2*	HQ Helical 1/4 λ	142 - 149 MHz	9 1/2"
KD2FREQHQ3*	HQ Helical 1/4 λ	150 - 161 MHz	9 1/2"
KD2FREQHQ4*	HQ Helical 1/4 λ	162 - 174 MHz	9 1/2"



TNC

TNC Male coaxial connector unskirted (TN type) KD3/13

TNC MALE			
KD3FREQHQ1*	HQ Helical 1/4 λ	136 - 140 MHz	9 1/2"
KD3FREQHQ2*	HQ Helical 1/4 λ	142 - 149 MHz	9 1/2"
KD3FREQHQ3*	HQ Helical 1/4 λ	150 - 161 MHz	9 1/2"
KD3FREQHQ4*	HQ Helical 1/4 λ	162 - 174 MHz	9 1/2"
KD3FREQHQ5*	HQ Helical 1/4 λ	220 - 222 MHz	9 1/2"
KD13(freq)*	1/4 λ	406 - 960 MHz	6"
TNCQ*	1/4 λ	136 - 512 MHz	Varies by freq

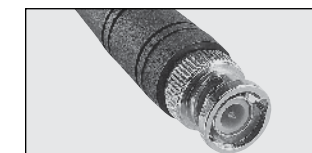

BNC

BNC Male coaxial connector unskirted KD4/14

BNC MALE			
KD4UHF*	Helical 1/4 λ	406 - 512 MHz	3"
KD4VHF1*	Helical 1/4 λ	136 - 141 MHz	8"
KD4VHF2*	Helical 1/4 λ	142 - 149 MHz	8"
KD4VHF3*	Helical 1/4 λ	150 - 161 MHz	8"
KD4VHF4*	Helical 1/4 λ	162 - 174 MHz	8"
KD4FREQHQ1*	HQ Helical 1/4 λ	136 - 140 MHz	9 1/2"
KD4FREQHQ2*	HQ Helical 1/4 λ	142 - 149 MHz	9 1/2"
KD4FREQHQ3*	HQ Helical 1/4 λ	150 - 161 MHz	9 1/2"
KD4FREQHQ4*	HQ Helical 1/4 λ	162 - 174 MHz	9 1/2"
KD4150T*	Helical 1/4 λ	130 - 180 MHz	Varies by freq
KD14(freq)*	1/4 λ	406 - 960 MHz	6"
KD14FREQHW1*	HW UHF 1/2 λ	315 - 409 MHz	16 1/2"
KD14FREQHW2*	HW UHF 1/2 λ	416 - 504 MHz	16 1/2"
BNCQ*	1/4 λ	136 - 512 MHz	Varies by freq



All factory tuned Kulduckies® are exact tuned to your specified frequency

* To order, replace the FREQ, UHF or VHF designation with your desired centered frequency.

PART NUMBER	ELECTRICAL TYPE	FREQUENCY BAND	APPROX LENGTH
5/16-32X3/8			
KD7FREQHQ1*	HQ Helical 1/4 λ	136 - 140 MHz	9 1/2"
KD7FREQHQ2*	HQ Helical 1/4 λ	142 - 149 MHz	9 1/2"
KD7FREQHQ3*	HQ Helical 1/4 λ	150 - 161 MHz	9 1/2"
KD7FREQHQ4*	HQ Helical 1/4 λ	162 - 174 MHz	9 1/2"



5/16-32X3/8

Male stud type mount (KR type) KD7

PART NUMBER	ELECTRICAL TYPE	FREQUENCY BAND	APPROX LENGTH
PL-259			
KD9FREQHQ1*	HQ Helical 1/4 λ	136 - 140 MHz	9 1/2"
KD9FREQHQ2*	HQ Helical 1/4 λ	142 - 149 MHz	9 1/2"
KD9FREQHQ3*	HQ Helical 1/4 λ	150 - 161 MHz	9 1/2"
KD9FREQHQ4*	HQ Helical 1/4 λ	162 - 174 MHz	9 1/2"
KD19(freq)*	1/4 λ	406 - 512 MHz	6"
PQ*	1/4 λ	144 - 512 MHz	Varies by freq

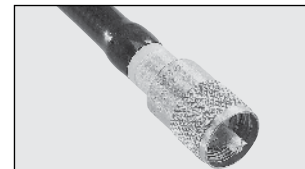

PL-259

Standard UHF Connector Male KD9/19

PART NUMBER	ELECTRICAL TYPE	FREQUENCY BAND	APPROX LENGTH
5/16-24 THDS Female			
KD22VHF1*	Helical 1/4 λ	136 - 141 MHz	8"
KD22VHF2*	Helical 1/4 λ	142 - 149 MHz	8"
KD22VHF3*	Helical 1/4 λ	150 - 161 MHz	8"
KD22VHF4*	Helical 1/4 λ	162 - 174 MHz	8"
KD22FREQHQ1*	HQ Helical 1/4 λ	136 - 140 MHz	9 1/2"
KD22FREQHQ2*	HQ Helical 1/4 λ	142 - 149 MHz	9 1/2"
KD22FREQHQ3*	HQ vv 1/4 λ	150 - 161 MHz	9 1/2"
KD22FREQHQ4*	HQ Helical 1/4 λ	162 - 174 MHz	9 1/2"



516-24THDS Female

Female threaded KD22



SPOTS!

SPOTS! FREQUENCY COLOR CODE (SEE COLOR SPOT ON ANTENNA TOP)

VHF	CENTER FREQUENCY	COLOR
144	138 - 150 MHz	Gray
156	150 - 162 MHz	Orange
160	154 - 166 MHz	Green
167	160 - 174 MHz	Red

UHF	CENTER FREQUENCY	COLOR
420	403 - 437 MHz	Blue
450	432 - 468 MHz	Yellow
470	450 - 490 MHz	Red
490	470 - 510 MHz	Green

800 / 900	CENTER FREQUENCY	COLOR
832	795 - 870 MHz	Blue
918	872 - 964 MHz	Red
1800	1710 - 1850 MHz	Black
1900	1850 - 1990 MHz	Black
2400	2400 - 2500 MHz	Black



SPOTS! CODE ANTENNA SELECTION GUIDE BY CONNECTOR TYPE

Determine connector type on the following pages and select the proper antenna based on frequency and type below. Field tunable antennas come with a cutting chart and cap to allow for tuning to exact frequency.

1/4-32X3/16 - MALE STUD CONNECTOR (MX TYPE)

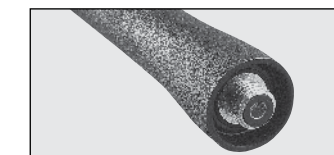

1/4-32X3/16

Male stud type mount with skirt (MX type)

Popular Brands Supported

Motorola, Kenwood, Maxon, Midland, Wilson, G.E., Vertex

PART NUMBER	FREQUENCY BAND (MHZ)	ANTENNA TYPE	APPROX LENGTH
SPHL10156	150 - 162	Helical Standard 1/4 λ	8"
SPHS10156	152 - 160	Helical Short 1/4 λ	4"
SPHL10160	154 - 166	Helical Standard - 1/4 λ	8"
SPHL10160IC*	CC to 157	Helical Standard 1/4 λ	8"
SPHL10167	160 - 174	Helical Standard 1/4 λ	8"
SPHL10167IC*	CC to 167	Helical Standard 1/4 λ	8"
SPWH10420	395 - 445	Whip Standard 1/4 λ	6"
SPHS10420	403 - 437	Helical Short 1/4 λ	3"
SPWH10450	425 - 475	Whip Standard 1/4 λ	6"
SPHS10450	432 - 468	Helical Short 1/4 λ	3"
SPWH10470	450 - 490	Whip Standard 1/4 λ	6"
SPHS10470	452 - 488	Helical Short 1/4 λ	3"
SPHL10FT	Field Tunable 136 - 221	Helical Standard 1/4 λ	8"
SPWH10FT	Field Tunable 400 - 512	Whip Standard 1/4 λ	6"

* This antenna is designed with a longer "skirt" for use with ICOM radios.



SPOTS!

M7 X 1.00 METRIC CONNECTOR (MD TYPE)

PART NUMBER	FREQUENCY BAND (MHZ)	ANTENNA TYPE	APPROX LENGTH
*SPEN14832	806 - 866	Whip - 1/2 – End Fed	7"
*SPWH14832	782 - 882	Whip - Standard - 1/4 λ	3"
*SPHS14832	800 - 865	Helical - Short - 1/4 λ	2.75"
*SPEN14918	890 - 960	Half – End Fed	6"
*SPHL14FT	Field Tunable 136 - 221	Helical - Standard - 1/4 λ	7"



M7.0X1.0

Male stud type connector unskirted (MD type)

Popular Brands Supported

G.E., Ericsson

BNC CONNECTOR (BN TYPE)

PART NUMBER	FREQUENCY BAND (MHZ)	ANTENNA TYPE	APPROX LENGTH
*SPHS15450	432 - 468	Helical - Short - 1/4 λ	3"
*SPHL15FT	Field Tunable 136 - 221	Helical - Standard - 1/4 λ	8"
*SPWH15FT	Field Tunable 400 - 512	Whip - Standard - 1/4 λ	6"



BNC

BNC Male coaxial connector unskirted

Popular Brands Supported

G.E., Kenwood, Motorola, Maxon, Johnson

BNC CONNECTOR COVERED TYPE (BNX TYPE)

PART NUMBER	FREQUENCY BAND (MHZ)	ANTENNA TYPE	APPROX LENGTH
*SPHL16FT	Field Tunable 136 - 221	Helical - Standard - 1/4 λ	8"
*SPWH16FT	Field Tunable 400 - 512	Whip - Standard - 1/4 λ	6"



BNC-S

BNC Male coaxial connector fully skirted (BNX type)

Popular Brands Supported

Ericsson

TNC CONNECTOR - STANDARD (TN TYPE) - EXPOSED BRIGHT FINISH

PART NUMBER	FREQUENCY BAND (MHZ)	ANTENNA TYPE	APPROX LENGTH
SPDA17806/2170LAR	806 - 960 / 1710 - 2170	Center Fed Dipole	8"
SPDA17832	824 - 894	Center Fed Dipole	8"
SPDA17850/1900	824 - 894 / 1850 - 1990	Center Fed Dipole	7.5"
SPDA17918	890 - 960	Center Fed Dipole	8"
SPDA171800	1710 - 1850	Center Fed Dipole	6.5"
SPDA171900	1850 - 1990	Center Fed Dipole	6.5"
SPDA172400	2400 - 2500	Center Fed Dipole	6"
SPDA17RP2400	2400 - 2500	Center Fed Dipole	6"
SPDA17RP2400/5900	2400 - 2500 / 4900 - 5900	Center Fed Dipole	6"
SPDA17RP918	890 - 960	Center Fed Dipole	8"
*SPHL17FT	Field Tunable 136 - 221	Helical - Standard - 1/4 λ	8"
*SPWH17FT	Field Tunable 400 - 512	Whip - Standard - 1/4 λ	6"
ICEBLADELT	698 - 960 / 1710 - 2170 / 2500 - 2700	Multiband	9"
ICEBLADEWT	698 - 960 / 1710 - 2170 / 2500 - 2700	Multiband	9"

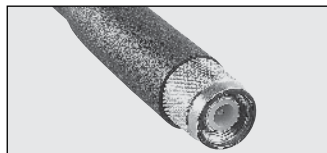

TNC

TNC Male coaxial connector unskirted (TN type)

Popular Brands Supported

Icom, Standard



SPOTS!

TNC CONNECTOR - COVERED (TNX TYPE)

PART NUMBER	FREQUENCY BAND (MHZ)	ANTENNA TYPE	APPROX LENGTH
SPHL18FT	Field Tunable 136 - 221	Helical - Standard - 1/4 λ	8"
SPWH18FT	Field Tunable 400 - 512	Whip - Standard - 1/4 λ	6"

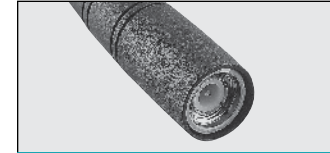

TNC-S

TNC Coaxial connector fully skirted (TNX type)

Popular Brands Supported

Vertex

SMA MALE STANDARD - EXTENDED BASE - T1 (SMS TYPE)

PART NUMBER	FREQUENCY BAND (MHZ)	ANTENNA TYPE	APPROX LENGTH
SPWH20832	782 - 882	Whip - Standard - 1/4 λ	3"
SPHS20832	800 - 864	Helical - Short - 1/4 λ	2.75"
SPWH20918	863 - 973	Whip - Standard - 1/4 λ	3"
SPHS20918	872 - 954	Helical - Short - 1/4 λ	2.75"
SPHL20FT	Field Tunable 136 - 221	Helical - Standard - 1/4 λ	8"
SPWH20FT	Field Tunable 400 - 512	Whip - Standard - 1/4 λ	6"



SMA MALE T1

SMA Male extended base (SMS Type)

Popular Brands Supported

Standard

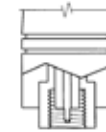

SMA FEMALE - NON STANDARD MOTOROLA TYPE (SF TYPE)

PART NUMBER	FREQUENCY BAND (MHZ)	ANTENNA TYPE	APPROX LENGTH
SPWB21150	136 - 174	Helical - Standard - 1/4 λ	6.75"
SPHL21156	150 - 162	Helical - Standard - 1/4 λ	8"
SPHS21156	152 - 160	Helical - Short - 1/4 λ	4"
SPHL21167	160 - 174	Helical - Standard - 1/4 λ	8"
SPHS21167	162 - 172	Helical - Short - 1/4 λ	4"
SPWH21450	425 - 475	Whip - Standard - 1/4 λ	6"
SPHS21450	432 - 468	Helical - Short - 1/4 λ	3"
SPHS21490	475 - 512	Helical - Short - 1/4 λ	3"
SPWH21832	782 - 882	Whip - Standard - 1/4 λ	3"
SPHS21832	800 - 864	Helical - Short - 1/4 λ	2.75"
SPWH21918	863 - 973	Whip - Standard - 1/4 λ	3"
SPHS21918	872 - 954	Helical - Short - 1/4 λ	2.75"
SPHL21FT	Field Tunable 136 - 221	Helical - Standard - 1/4 λ	8"
SPWH21FT	Field Tunable 400 - 512	Whip - Standard - 1/4 λ	6"

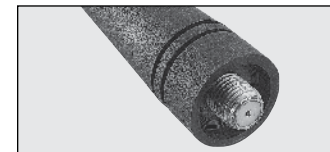

SMA F T1

SMA Female flush insulator & partial skirt (SF Type)

Popular Brands Supported

Motorola





SPOTS!

SMA FEMALE STANDARD - FLUSH BASE - T2 (SFJ TYPE)

PART NUMBER	FREQUENCY BAND (MHZ)	ANTENNA TYPE	APPROX LENGTH
SPWB22150	136 - 174	Helical - Standard - 1/4 λ	6.75"
SPHL22156	150 - 162	Helical - Standard - 1/4 λ	8"
SPHL22167	160 - 174	Helical - Standard - 1/4 λ	8"
SPWH22450	425 - 475	Whip - Standard - 1/4 λ	6"
SPHS22450	432 - 468	Helical - Short - 1/4 λ	3"
SPWH22470	450 - 490	Whip - Standard - 1/4 λ	6"
SPHS22470	452 - 468	Helical - Short - 1/4 λ	3"
SPHS22490	475 - 512	Helical - Short - 1/4 λ	3"
SPWH22832	782 - 882	Whip - Standard - 1/4 λ	3"
SPHS22832	800 - 864	Helical - Short - 1/4 λ	2.75"
SPWH22918	863 - 973	Whip - Standard - 1/4 λ	3"
SPHS22918	872 - 954	Helical - Short - 1/4 λ	2.75"
SPHL22FT	Field Tunable 136 - 221	Helical - Standard - 1/4 λ	8"
SPWH22FT	Field Tunable 400 - 512	Whip - Standard - 1/4 λ	6"



SMA F T2

SMA Female recessed insulator & partial (short) skirt (SFJ type)

Popular Brands Supported

EF Johnson, Kenwood



SMA FEMALE STANDARD - HALF SKIRT BASE - T3 (SFU TYPE)

PART NUMBER	FREQUENCY BAND (MHZ)	ANTENNA TYPE	APPROX LENGTH
SPWB23150	136 - 174	Helical - Standard - 1/4 λ	6.75"
SPHL23167	160 - 174	Helical - Standard - 1/4 λ	8"
SPWH23450	425 - 475	Whip - Standard - 1/4 λ	6"
SPHS23450	432 - 468	Helical - Short - 1/4 λ	3"
SPWH23470	450 - 490	Whip - Standard - 1/4 λ	6"
SPHS23470	452 - 488	Helical - Short - 1/4 λ	3"
SPWH23490	470 - 512	Whip - Standard - 1/4 λ	6"
SPHS23490	475 - 512	Helical - Short - 1/4 λ	3"
SPWH23832	782 - 882	Whip - Standard - 1/4 λ	3"
SPWH23918	863 - 973	Whip - Standard - 1/4 λ	3"
SPHS23918	872 - 954	Helical - Short - 1/4 λ	2.75"
SPHL23FT	Field Tunable 136 - 221	Helical - Standard - 1/4 λ	8"
SPWH23FT	Field Tunable 400 - 512	Whip - Standard - 1/4 λ	6"

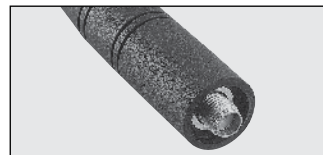

SMA F T3

SMA Female recessed insulator & partial (long) skirt (SFU type)

Popular Brands Supported

Kenwood (2005 and newer models), Uniden, King



SPOTS!

SMA MALE - FLUSH BASE - T2 (SM TYPE)

PART NUMBER	CONNECTOR	FREQUENCY BAND (MHZ)	ANTENNA TYPE	APPROX LENGTH
SPDA24700/2700	SMA Male	698-960/1710-2170/2500-2700	Multiband	9"
SPDA24832	SMA	824 - 894	Center Fed Dipole	9"
SPDA24850/1900	SMA	824 - 894 / 1850 - 1990	Center Fed Dipole	7.5"
SPDA24918	SMA M T2	890 - 960	Center Fed Dipole	8"
SPDA241800	SMA M T2	1710 - 1880	Center Fed Dipole	6.5"
SPDA241900	SMA M T2	1850 - 1990	Center Fed Dipole	6.5"
SPDA242400	SMA	2400 - 2500	Center Fed Dipole	6"
SPDA24RP918	SMA M T2 RP	890 - 960	Center Fed Dipole	8"
SPDA24RP 2400	SMA M T2 RP	2400 - 2500	Center Fed Dipole	6"
SPDP24832	SMA M T2	824 - 894	Center Fed Dipole	8"
SPDP24918	SMA M T2	890 - 960	Center Fed Dipole	
SPDP242400	SMA M T2	2400 - 2500	Center Fed Dipole	3.5"
SPEN24815	SMA M T2	760 - 870	Whip - End Fed - 1/2 λ	7
*SPHS24832	SMA M T2	800 - 864	Helical - Short - 1/4 λ	2.75"
*SPHS24918	SMA M T2	872 - 954	Helical - Short - 1/4 λ	2.75"
*SPWB24150	SMA M T2	136 - 174	Wideband	7.5"
*SPWB24425	SMA M T2	380 - 470	Wideband	6.5"
*SPWB24480	SMA M T2	440 - 520	Wideband	6"
*SPWH24815	SMA M T2	760 - 870	Whip - Short - 1/4 Wave	3.5
*SPWH24918	SMA M T2	863 - 973	Whip - Standard - 1/4 λ	3"
*SPHL24FT	SMA M T2	Field Tunable 136 - 221	Helical - Standard - 1/4 λ	8"
*SPWH24FT	SMA M T2	Field Tunable 400 - 512	Whip - Standard - 1/4 λ	6"
ICEBLADELT	SMA Male	698-960/1710-2170/2500-2700	Multiband	9"
ICEBLADEWS	SMA Male	2400-2500/4900-5900	Multiband	9"

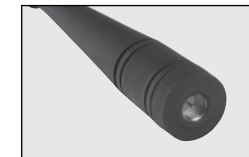

SMA MALE T2

SMA Male flush base (SM Type)

Popular Brands

G.E., Technophone, Relm





NMO

The most popular mount is the NMO or "new Motorola" mount. NMO consists of a nickel plated brass bushing and silver plated center contact for maximum conductivity and corrosion resistance.



NMOHF

"Antennas operating above 1700MHz require a better match than the traditional NMO mount can provide. PulseLarsen offers a totally redesigned standard NMO mount which boasts a variety of innovative features such as:

- Simply pull the center pin to convert from low frequency to high frequency application
- High quality components such as gold plated conductors and precision tolled body parts
- Accommodates a variety of coax types
- Fully sealed solder connections
- Improves lower frequency performance as well



KG

Patented KG (Kulglass) glass mount antennas feature low impedance power transfer and the industry's smallest footprint. Virtually no loss difference (0.5dB) through the glass and the no-holes mounting makes it an ideal option.



PO

PO series mount is an SO239/UHF type mount which fits in a 5/8" hole. The mount is made of brass for conductivity and stainless steel for durability.



MHW

Similar to the PO series in that it mounts directly to an SO239/UHF connector, the MHW is a half-wave design requiring no ground plane for operation. The MHW can mount directly on a radio or any of the PO permanent or temporary mounts.



PHW

PHW series antenna is a half-wave antenna with a flexible radiating element. Useful for quick set up, it is designed to be suspended from any non-metallic object by the radiating element. No ground plane is required. The antenna interfaces directly with a PL-259 connector.



LM

Based on a 5/16" - 24 thread stud, this 3/4" hole mount provides durable installation with solid ground plane contact to maximize antenna gain potential. In addition, the thread connection prevents system static caused by intermittent contact between the coil and the mount.



OM

OM series is a self-mounting, half antenna. The coax is soldered directly to the antenna coil, requiring only a 3/8" hole. The half wave design makes it ideal for mounting on any surface, including wood and fiberglass, as no ground plane is required. The OM is self mounting with three nuts and bolts or self-tapping screws.



MM/MS

The MM/MS series are complete antenna units incorporating a magnetic base with a whip antenna and coaxial cable.

 **PulseLarsen**
Antennas

 Call us at
+1.800.ANTENNA

 Visit our website at
pulselarsenantennas.com

 Connect with us on twitter
PulseLarsen1





LOW BAND COILS/WHIPS

Model	Type	Frequency (MHz)	Gain (dBi)	Max Height (In)	Power Rating (Watts)	Whip Color	Cable Assembly/Mount
NMO27BCO	Loaded 1/4 λ	27-30		4	150	Coil Only	Order Separately
NMO27B	Loaded 1/4 λ	27-30	2	52.5	150	Black	Order Separately
NMO27C	Loaded 1/4 λ	27-30	2	52.5	150	Stainless	Order Separately
NMO30BCO	Loaded 1/4 λ	30-34		4	150	Coil Only	Order Separately
NMO30B	Loaded 1/4 λ	30-34	2	57.5	150	Black	Order Separately
NMO30C	Loaded 1/4 λ	30-34	2	57.5	150	Stainless	Order Separately
NMO34BCO	Loaded 1/4 λ	34-40		4	150	Coil Only	Order Separately
NMO34B	Loaded 1/4 λ	34-40	2	57.5	150	Black	Order Separately
NMO34C	Loaded 1/4 λ	34-40	2	57.5	150	Stainless	Order Separately
NMO40BCO	Loaded 1/4 λ	40-50		3.5	150	Coil Only	Order Separately
NMO40B	Loaded 1/4 λ	40-50	2	57.5	150	Black	Order Separately
NMO40C	Loaded 1/4 λ	40-50	2	57.5	150	Stainless	Order Separately
NMOWB40C	Loaded 1/4 λ	40-50	2	55	150	Stainless	Order Separately
NMO50BCO	Loaded 1/4 λ	47-54		3.5	150	Coil Only	Order Separately
NMO50B	Loaded 1/4 λ	47-54	2	52.5	150	Black	Order Separately
NMO50C	Loaded 1/4 λ	47-54	2	52.5	150	Stainless	Order Separately
NMOQ52C	1/4 λ	52-88	2	55	150	Stainless	Order Separately
NMOQ88C	1/4 λ	88-136	2	35	150	Stainless	Order Separately
Q52	1/4 λ	52-88	2	55	200	Stainless	Order Separately
Q88	1/4 λ	88-136	2	35	200	Stainless	Order Separately



NMO Low Band



NMOQ Low Band



NMOWB Low Band



Q Series Low Band

The most commonly used cable assembly/mount is the NMOKHFUD (27 MHz to 6 GHz) with 17' of UD (RG-58/U Dual Shield).

NOTE: Larsen springs (SPRING or SPRINGB) can be added to most mobile antennas.



VHF COILS/WHIPS

Model	Type	Frequency (MHz)	Gain (dBi)	Max Height (In)	Power Rating (Watts)	Whip Color	Cable Assembly/Mount	Connector
MHW150BCO	1/2 λ	144-174		2.5	200	Coil Only	Order Separately	
MHW150C	1/2 λ	144-174	2	51.5	200	Stainless	Order Separately	
NMO150BCO	5/8 λ	144-174		2.5	200	Coil Only	Order Separately	
NMO150B	5/8 λ	144-174	5.14	51.5	200	Black	Order Separately	
NMO150C	5/8 λ	144-174	5.14	51.5	200	Stainless	Order Separately	
NMO150BK	5/8 λ	144-174	5.14	51.5	200	Black	17' RG-58A/U	PL-259
NMO150CK	5/8 λ	144-174	5.14	51.5	200	Stainless	17' RG-58A/U	PL-259
NMO150HWBCO	5/8 λ	144-174		2.5	200	Coil Only	Order Separately	
NMO150BHW	1/2 λ	144-174	2	51.5	200	Black	Order Separately	
NMO150CHW	1/2 λ	144-174	2	51.5	200	Stainless	Order Separately	
NMOU150D	Loaded 1/4 λ	150-165	2	18	200	Black	Order Separately	
NMOU155D	Loaded 1/4 λ	155-170	2	18	200	Stainless	Order Separately	
NMOWB150BCO	Wideband 1/2 λ	135-174		2.75	100	Coil Only	Order Separately	
NMOWB150B	Wideband 1/2 λ	135-174	2	51.75	100	Black	Order Separately	
NMOWB150C	Wideband 1/2 λ	135-174	2	51.75	100	Stainless	Order Separately	
NMOWB150BK	Wideband 1/2 λ	135-174	2	51.75	100	Black	17' RG-58A/U	PL-259
NMOWBQB*	Wideband 1/4 λ	150-170	2	20	200	Black	Order Separately	
NMOWBQC*	Wideband 1/4 λ	150-170	2	20	200	Stainless	Order Separately	
NMOQW144	1/4 λ	144-152	2	19	200	Stainless	Order Separately	
NMOQW152	1/4 λ	152-162	2	19	200	Stainless	Order Separately	
LM150BCO	5/8 λ	144-174		2.75	200	Coil Only	Order Separately	
LM150B	5/8 λ	144-174	5.14	51.75	200	Black	Order Separately	
LM150C	5/8 λ	144-174	5.14	51.75	200	Stainless	Order Separately	
LMWBQ	Wideband 1/4 λ	150-170	2	18.5	200	Stainless	Order Separately	
LMWBQB	Wideband 1/4 λ	150-170	2	18.5	200	Black	Order Separately	
PO150BCO	5/8 λ	144-174	2	2.5	200	Coil Only	Order Separately	
PO150B	5/8 λ	144-174	5.14	51.5	200	Black	Order Separately	
PO150C	5/8 λ	144-174	5.14	51.5	200	Stainless	Order Separately	

* NEW POGO PIN MODELS

Model	Type	Frequency (MHz)	Gain (dBi)	Max Height (in)	Power Ratings (Watts)	Whip Color	Cable Assembly/Mount	Mount Type
NMOWBPQB	Wideband 1/4 λ	150-170	2	20	200	Black	Order Separately	NMO with Pogo Pin
NMOWBPQC	Wideband 1/4 λ	150-170	2	20	200	Stainless	Order Separately	NMO with Pogo Pin



MHW



NMO150 / NMOHW



NMOU



NMOWB



NMOWBQ

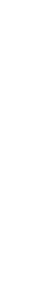

NMOQW



LMWB



LM



PO



Pogo Pin Base

The most commonly used cable assembly/mount is the NMOKHFUD (27 MHz to 6 GHz) with 17' of UD (RG-58/U Dual Shield).

NOTE: Larsen springs (SPRING or SPRINGB) can be added to most mobile antennas.





VHF GLASS MOUNT

Model	Type	Frequency (MHz)	Gain (dBi)	Max Height (In)	Power Rating (Watts)	Whip Color	Cable Assembly/ Mount	Connector
KGFFREQUDPL2	VHF Disguise	140-149	2	20	100	Black	14' RG-58/U	PL-259
KGFFREQUDPL3	VHF Disguise	150-159	2	20	100	Black	14' RG-58/U	PL-259
KGFFREQUDPL4	VHF Disguise	160-170	2	20	100	Black	14' RG-58/U	PL-259
KG144O/S	1/2 λ	144-160	2	48	100	Black	Order Separately	
KG144UD	1/2 λ	144-160	2	48	100	Black	14' RG-58/U	No Conn
KG144UDPL	1/2 λ	144-160	2	48	100	Black	14' RG-58/U	PL-259
KG160O/S	1/2 λ	160-174	2	47	100	Black	Order Separately	
KG160UD	1/2 λ	160-174	2	47	100	Black	14' RG-58/U	No Conn
KG160UDPL	1/2 λ	160-174	2	47	100	Black	14' RG-58/U	PL-259
KGVHFUDI/S	Inside Cable Unit	144-174			100		14' RG-58/U	No Conn



Glass Mount



Low Profile

VHF LOW PROFILE

Model	Frequency (MHz)	Gain (dBi)	Size H x DIA (In)	Power Rating (Watts)	Color	Cable Assembly/ Mount
LP152NMO	151.02-152.98	2	3.75 x 4.5	60	Black	Order Separately
LP154NMO	152.96-155.04	2	3.75 x 4.5	60	Black	Order Separately
LP156NMO	154.42-156.58	2	3.75 x 4.5	60	Black	Order Separately
LP158NMO	156.38-158.62	2	3.75 x 4.5	60	Black	Order Separately
LP160NMO	158.33-160.67	2	3.75 x 4.5	60	Black	Order Separately
LP162NMO	160.29-162.71	2	3.75 x 4.5	60	Black	Order Separately
LP164NMO	162.75-165.25	2	3.75 x 4.5	60	Black	Order Separately
LP167NMO	165.21-167.79	2	3.75 x 4.5	60	Black	Order Separately
LP169NMO	167.68-170.32	2	3.75 x 4.5	60	Black	Order Separately
LP171NMO	170.16-172.84	2	3.75 x 4.5	60	Black	Order Separately
LP174NMO	172.14-174.86	2	3.75 x 4.5	60	Black	Order Separately

The most commonly used cable assembly/mount is the NMOKHFUD (27 MHz to 6 GHz) with 17' of UD (RG-58/U Dual Shield).



VHF DIRECT MOUNTS

Model	Type	Frequency (MHz)	Gain (dBi)	Max Height (In)	Power Rating (Watts)	Whip Color	Cable Assembly	Connector
OM150BCO	1/2 λ	144-174		3	200	Coil Only	17' RB-58A/U	PL-259
OM150CK	1/2 λ	144-174	2	51.75	200	Stainless	17' RB-58A/U	PL-259
PHW150BCO	1/2 λ	144-174	2	2.5	200	Coil Only	Order Separately	
PHW150C	1/2 λ	144-174	2	56.5	200	Stainless	Order Separately	

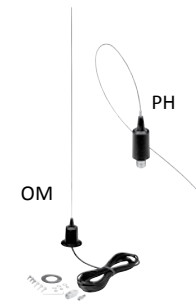

OM



MST

VHF MAGNETIC MOUNTS

Model	Type	Frequency (MHz)	Gain (dBi)	Max Height (In)	Power Rating (Watts)	Whip Color	Cable Assembly	Connector
MSTFME	Tunable 1/4 λ	144-965	2	21	50	Black	12' RG-174	FME Crimp

VHF 220 MHz

Model	Type	Frequency (MHz)	Gain (dBi)	Max Height (In)	Power Rating (Watts)	Whip Color	Cable Assembly/ Mount
NMO220BCO	5/8 λ	220-225	5.2	2.5	200	Coil Only	Order Separately
NMO220B	5/8 λ	220-225	5.2	30	200	Black	Order Separately
NMO220C	5/8 λ	220-225	5.2	30	200	Stainless	Order Separately
NMO220HWBCO	1/2 λ	220-225		3	200	Coil Only	Order Separately
NMO220CHW	1/2 λ	220-225	2	30	200	Stainless	Order Separately
NMO220CS	5/8 λ	217-220	5.2	3.15	200	Stainless	Order Separately



NMOHW

The most commonly used cable assembly/mount is the NMOKHFUD (27 MHz to 6 GHz) with 17' of UD (RG-58/U Dual Shield).

NOTE: Larsen springs (SPRING or SPRINGB) can be added to most mobile antennas.





UHF COILS/WHIPS

Model	Type	Frequency (MHz)	Gain (dBi)	Max Height (in)	Power Rating (Watts)	Whip Color	Cable Assembly
LMUHFBASEB	Base Only	406-512		2	200	Coil Only	Order Separately
LM406C	5/8 over 1/2 λ	406-420	5.6	33	200	Stainless	Order Separately
LM440C	5/8 over 1/2 λ	440-460	5.6	33	200	Stainless	Order Separately
LM450C	5/8 over 1/2 λ	450-470	5.6	33	200	Stainless	Order Separately
NMO4063CS	5/8 λ	406-430	5.14	19	200	Stainless	Order Separately
NMO4303CS	5/8 λ	430-450	5.14	19	200	Stainless	Order Separately
NMO4503CS	5/8 λ	450-470	5.14	19	200	Stainless	Order Separately
NMO4703CS	5/8 λ	470-490	5.14	19	200	Stainless	Order Separately
NMO4903CS	5/8 λ	490-512	5.14	19	200	Stainless	Order Separately
NMO406B	5/8 over 1/2 λ	406-420	5.6	33	200	Black	Order Separately
NMO406C	5/8 over 1/2 λ	406-420	5.6	33	200	Stainless	Order Separately
NMO420B	5/8 over 1/2 λ	420-440	5.6	33	200	Black	Order Separately
NMO420C	5/8 over 1/2 λ	420-440	5.6	33	200	Stainless	Order Separately
NMO440B	5/8 over 1/2 λ	440-460	5.6	33	200	Black	Order Separately
NMO440C	5/8 over 1/2 λ	440-460	5.6	33	200	Stainless	Order Separately
NMO450B	5/8 over 1/2 λ	450-470	5.6	33	200	Black	Order Separately
NMO450C*	5/8 over 1/2 λ	450-475	5.6	33	200	Stainless	Order Separately
NMO470C	5/8 over 1/2 λ	470-490	5.6	33	200	Stainless	Order Separately
NMO490B	5/8 over 1/2 λ	490-512	5.6	33	200	Black	Order Separately
NMO490C	5/8 over 1/2 λ	490-512	5.6	33	200	Stainless	Order Separately
NMO406HWBCO	Base Only	406-420		2.5	200	Coil Only	Order Separately
NMO406CHW	1/2 λ Collinear	406-420	5.5	35.5	200	Stainless	Order Separately
NMO420CHW	1/2 λ Collinear	420-440	5.5	35.5	200	Stainless	Order Separately
NMO440CHW	1/2 λ Collinear	440-460	5.5	35.5	200	Stainless	Order Separately
NMO450HWBCO	Base Only	420-512		2.5	200	Coil Only	Order Separately
NMO450CHW	1/2 λ Collinear	450-470	5.5	35.5	200	Stainless	Order Separately
NMOQBASE1B	Base Only	Whip Size .070		2	200	Coil Only	Order Separately
NMOQBASE2B	Base Only	Whip Size .100		2	200	Coil Only	Order Separately
NMOQBASE3B	Base Only	Whip Size .125		2	200	Coil Only	Order Separately
NMOUHBBASEB	Base Only	Whip Size .100		2	200	Coil Only	Order Separately
NMOQW406	1/4 λ	406-430	2	7	200	Stainless	Order Separately
NMOQW450	1/4 λ	450-470	2	7	200	Stainless	Order Separately
NMOWB406BCO	Wide Band Coil	406-512		2.5	200	Coil Only	Order Separately
NMOWB406C	Wide Band	406-430	5.5	35.5	200	Stainless	Order Separately
NMOWB430C	Wide Band	430-455	5.5	35.5	200	Stainless	Order Separately
NMOWB450C	Wide Band	450-475	5.5	35.5	200	Stainless	Order Separately
NMOWB470C	Wide Band	470-495	5.5	35.5	200	Stainless	Order Separately
NMOWB490C	Wide Band	490-515	5.5	35.5	200	Stainless	Order Separately

* NEW POGO PIN MODELS

Model	Type	Frequency (MHz)	Gain (dBi)	Max Height (in)	Power Ratings (Watts)	Whip Color	Cable Assembly/Mount	Mount Type
NMOP450C	5/8 over 1/2 λ	450-475	5.6	33	200	Stainless	Order Separately	NMO with Pogo Pin

The most commonly used cable assembly/mount is the NMOKHFUD (27 MHz to 6 GHz) with 17' of UD (RG-58/U Dual Shield).

NOTE: Larsen springs (SPRING or SPRINGB) can be added to most mobile antennas.



Pogo Pin Base



UHF GLASS MOUNT

Model	Type	Frequency (MHz)	Gain (dBi)	Max Height (in)	Power Rating (Watts)	Whip Color	Cable Assembly/ Mount	Connector
KG406O/S	1/2 λ	406-420	2	15	100	Black	Order Separately	
KG406UD	1/2 λ	406-420	2	15	100	Black	14' RG-58/U	No Conn
KG406UDPL	1/2 λ	406-420	2	15	100	Black	14' RG-58/U	PL-259
KG420O/S	1/2 λ	420-440	2	15	100	Black	Order Separately	
KG420UDPL	1/2 λ	420-440	2	15	100	Black	14' RG-58/U	PL-259
KG450O/S	1/2 λ	450-470	2	15	100	Black	Order Separately	
KG450UD	1/2 λ	450-470	2	15	100	Black	14' RG-58/U	No Conn
KG450UDPL	1/2 λ	450-470	2	15	100	Black	14' RG-58/U	PL-259
KG470O/S	1/2 λ	470-490	2	15	100	Black	Order Separately	
KG470UD	1/2 λ	470-490	2	15	100	Black	14' RG-58/U	No Conn
KG490O/S	1/2 λ	490-512	2	15	100	Black	Order Separately	
KG490UD	1/2 λ	490-512	2	15	100	Black	14' RG-58/U	No Conn
KGUHFUDI/S	Inside Coupler Only	406-512			100		14' RG-58/U	No Conn



Glass Mount



Inside Coupler



Outside

UHF LOW PROFILE

Model	Frequency (MHz)	Gain (dBi)	Size H x DIA (in)	Power Rating (Watts)	Color	Cable Assembly/ /Mount
LP406NMO	406-420		1.5 x 4.5	100	Black	Order Separately
LP406NMOW	406-420	2	1.5 x 4.5	100	White	Order Separately
LP420NMO	416-430	2	1.5 x 4.5	100	Black	Order Separately
LP420NMOW	416-430	2	1.5 x 4.5	100	White	Order Separately
LP450NMO	450-470	2	1.5 x 4.5	100	Black	Order Separately
LP450NMOW	450-470	2	1.5 x 4.5	100	White	Order Separately
LP470NMO	470-490	2	1.5 x 4.5	100	Black	Order Separately
LP470NMOW	470-490	2	1.5 x 4.5	100	White	Order Separately
LP490NMO	490-512	2	1.5 x 4.5	100	Black	Order Separately
LP490NMOW	490-512	2	1.5 x 4.5	100	White	Order Separately
LPT450NMO	450-470	2	4.5 x 1.5	100	Black	Order Separately
LPT450/512NMO	450-520	4.6	3.5x1.5	100	Black	Order Separately



LP



LPT450/512NMO



LPT

The most commonly used cable assembly/mount is the NMOKHFUD (27 MHz to 6 GHz) with 17' of UD (RG-58/U Dual Shield).



UHF DIRECT MOUNTS

Model	Type	Frequency (MHz)	Gain (dBi)	Size (In)	Power Rating (Watts)	Whip Color	Cable Assembly	Connector
LP450	Low Profile	450-470	2	1.25H x 5.25D	100	N/A	17' RG-58/U	No Conn
OM406BCO	1/2 λ	406-440		4	100	Coil Only	17' RG-58A/U	PL259
OM450BCO	1/2 λ	440-512		4	100	Coil Only	17' RG-58A/U	PL259
OM406CK	1/2 λ Collinear	406-420	5.5	35.5	100	Stainless	17' RG-58A/U	PL259
OM420CK	1/2 λ Collinear	420-440	5.5	35.5	100	Stainless	17' RG-58A/U	PL259
OM450CK	1/2 λ Collinear	450-470	5.5	35.5	100	Stainless	17' RG-58A/U	PL259
OM470CK	1/2 λ Collinear	470-490	5.5	35.5	100	Stainless	17' RG-58A/U	PL259

LP Direct Mount



OM

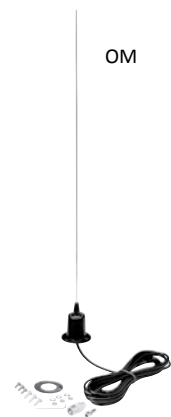

UHF MAGNETIC MOUNTS

Model	Type	Frequency (MHz)	Gain (dBi)	Max Height (In)	Power Rating (Watts)	Whip Color	Cable Assembly	Connector
MSTFME	Tunable 1/4 λ	144-965	2	21	50	Black	12' RG-174	FME Crimp
MSTBNCFT	Tunable 1/4 λ	144-965	2	21	50	Black	12' RG-174	TNC

MST



UHF STEALTH BLADES

Stealth Blade antennas have a gain of 2.14 dBi, a maximum power of 3 Watts and linear polarization.

Model	Frequency (MHz)	Bandwidth % @1.5/2:1	Dimensions L x W (In)	Coax	Connector
SB450FME12	450-470	20/30	10" x 0.75"	12' RG-316	FME

SB

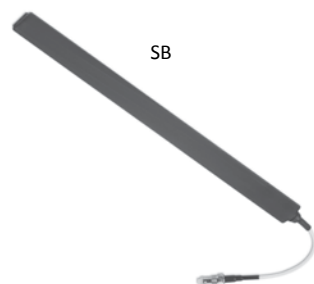

MULTI BAND COILS/WHIPS

Model	Type	Frequency (MHz)	Gain (dBi)	Max Height (in)	Power Rating (Watts)	Whip Color	Cable Assembly
NMO2/70BCO	Dual Band Coil	144-148 / 440-450			100	Coil Only	Order Separately
NMO2/70B	VHF: Center Loaded 1/2 λ	144-148	3.8	34.5	100	Black	Order Separately
NMO2/70C	UHF: Collinear	440-450	5.2				
NMO2/70SH*	VHF: Center Loaded 1/2 λ	144-148	2.14	19	200	Stainless	Order Separately
	UHF: Center Loaded 3/4 λ	440-450	4				
NMO150/450C	VHF: Center Loaded 1/2 λ	150-154	3.8	37.25	100	Stainless	Order Separately
	UHF: Collinear	450-460	5.2				
NMO150/450/800*	Tri Band	150-165 / 450-470 / 806-940	2.14	16.5	100	Black	Order Separately

* NEW POGO PIN MODELS

Model	Type	Frequency (MHz)	Gain (dBi)	Max Height (in)	Power Ratings (Watts)	Whip Color	Cable Assembly/Mount	Mount Type
NMOP2/70SH	VHF: Center Loaded UHF: Center Loaded 3/4 λ 1/2 λ	144-148 440-450	2.14 4	19	200	Stainless	Order Separately	NMO with Pogo Pin
NMOP150/450/800	Tri Band	150-165 / 450-470 / 806-940	-7/0/1	16.5	100	Black Stainless	Order Separately	NMO with Pogo Pin
NMO150/450/758	Tri Band	150-165 / 450-470 / 806-940	0/5/4	17.8	100	Black	Order Separately	NMO with Pogo Pin

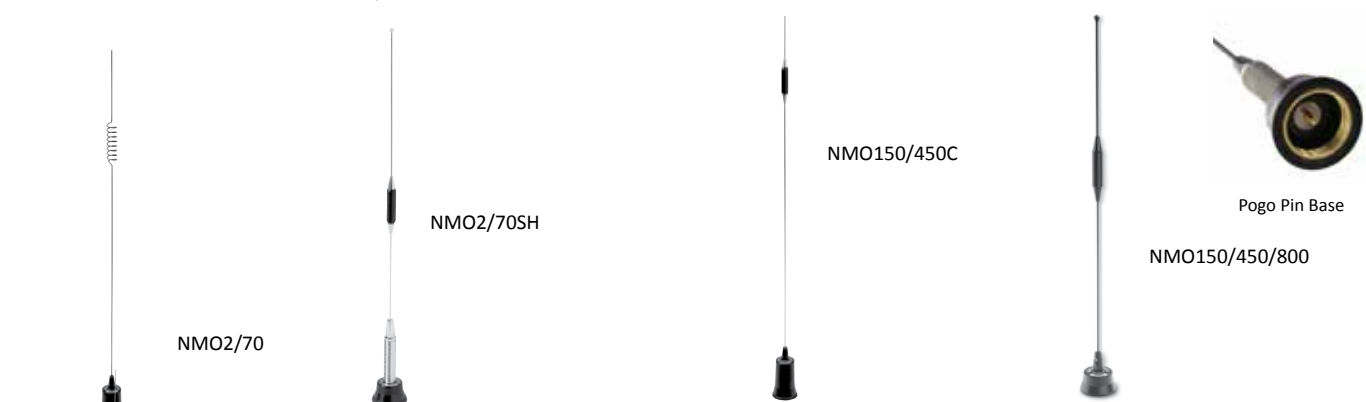

MULTI BAND VHF/UHF GLASS MOUNT

Model	Type	Frequency (MHz)	Gain (dBi)	Max Height (in)	Power Rating (Watts)	Whip Color	Cable Assembly	Connector
KG2/70CXPL	1/2 λ Collinear	144-148 / 442-448	2	32.75	100	Black	14' RG-58A/U	PL-259
KG2/70CXFME	1/2 λ Collinear	144-148 / 442-448	2	32.75	100	Black	14' RG-58A/U	FME

KG2/70



MULTI BAND VHF/UHF MAGNETIC MOUNTS

Model	Type	Frequency (MHz)	Gain (dBi)	Max Height (in)	Power Rating (Watts)	Whip Color	Cable Assembly	Connector
MM2/70PL	VHF: Center Loaded 1/4 λ	144-148	2	21	50	Black	12' RG-58A/U	PL-259
	UHF: Center Loaded 3/4 λ	442-448	4					

MM2/70



The most commonly used cable assembly/mount is the NMOKFUD (27 MHz to 6 GHz) with 17' of UD (RG-58/U Dual Shield).

TUNABLE 1/4 WAVE 136-960 MHz



ALL MADE IN THE USA

TUNABLE 1/4 WAVE COILS/WHIPS

Model	Frequency (MHz)	Gain (dBi)	Max Height (In)	Power Rating (Watts)	Whip Color	Cable Assembly
NMOQSPEC	136-960	2	22	200	Stainless	Order Separately
NMOQSPECB	136-960	2	22	200	Black	Order Separately
NMOQC	136-512	2	23	200	Stainless	Order Separately
NMOQB	136-512	2	23	200	Black	Order Separately
PQ	136-512	2	22	200	Stainless	Order Separately
Q	136-512	2	22	200	Stainless	Order Separately
QB	136-512	2	22	200	Black	Order Separately

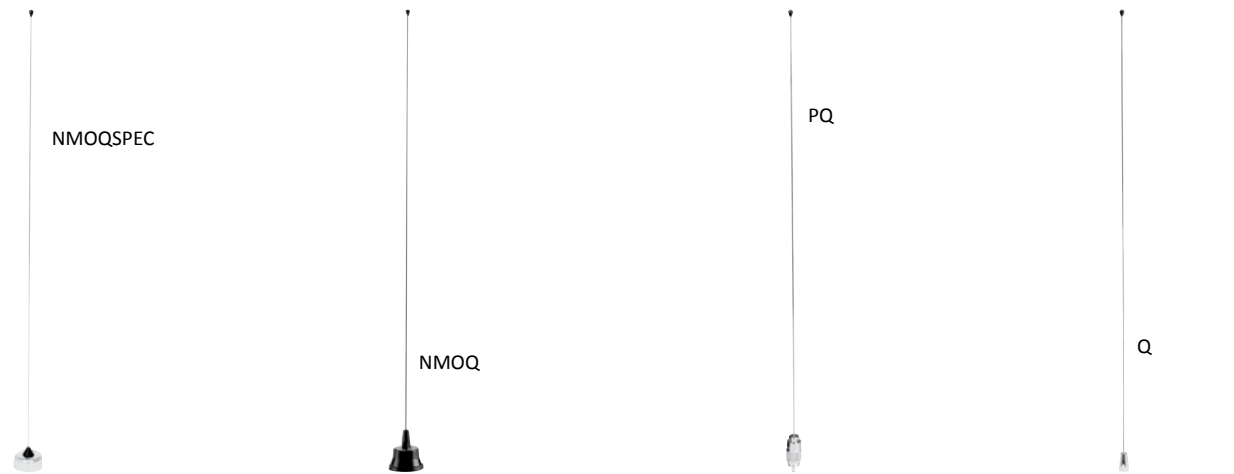

TUNABLE 1/4 WAVE MAGNETIC MOUNTS

Model	Frequency (MHz)	Gain (dBi)	Max Height (In)	Power Rating (Watts)	Whip Color	Cable Assembly	Connector
MSTFME	144-965	2	21	50	Black	12' RG-174	FME Crimp



* NEW POGO PIN MODELS

Model	Type	Frequency (MHz)	Gain (dBi)	Max Height (in)	Power Ratings (Watts)	Whip Color	Cable Assembly/Mount	Mount Type
NMOP5T900B	5/8 over 5/8 over 1/4 λ	890-960	7.2	18	200	Black	Order Separately	NMO with Pogo Pin



Pogo Pin Base

The most commonly used cable assembly/mount is the NMOKHFUD (27 MHz to 6 GHz) with 17' of UD (RG-58/U Dual Shield).



ALL MADE IN THE USA

700/800/900/1850 MHz

700/800/900/1850 MHz COILS/WHIPS

Model	Type	Frequency (MHz)	Gain (dBi)	Max Height (In)	Power Rating (Watts)	Whip Color	Cable Assembly and Connector
LM800	5/8 over 1/2 λ	806-866	5.6	14.5	200	Stainless	Order Separately
LM825	5/8 over 1/2 λ	824-896	5.6	14.5	200	Stainless	Order Separately
LM900	5/8 over 1/2 λ	890-960	5.6	14.5	200	Stainless	Order Separately
NMOQW700	1/4 λ	740-806	2	3	200	Stainless	Order Separately
NMOQW800	1/4 λ	806-896	2	3	200	Stainless	Order Separately
NMOQW900	1/4 λ	890-970	2	3	200	Stainless	Order Separately
NMOQSPEC800B	1/4 λ	806-896	2	4	200	Black	Order Separately
NMOQSPEC900B	1/4 λ	890-970	2	4	200	Black	Order Separately
NMOQ700B	1/4 λ	740-806	2	4.5	200	Black	Order Separately
NMOQ800B	1/4 λ	806-896	2	4.5	200	Black	Order Separately
NMOQ900B	1/4 λ	890-960	2	4.5	200	Black	Order Separately
NMOSPEC800	5/8 over 1/4 λ	806-866	5.4	13.5	200	Stainless	Order Separately
NMOSPEC825	5/8 over 1/4 λ	824-896	5.4	13.5	200	Stainless	Order Separately
NMOSPEC900	5/8 over 1/4 λ	890-960	5.4	13.5	200	Stainless	Order Separately
NMO3HD800B	5/8 over 1/4 λ	806-866	5.4	13.75	200	Black	Order Separately
NMO3HD825B	5/8 over 1/4 λ	824-896	5.4	13.75	200	Black	Order Separately
NMO3HD900B	5/8 over 1/4 λ	890-960	5.4	13.75	200	Black	Order Separately
NMO3E700B	5/8 over 1/4 λ	740-806	5.4	13.5	200	Black	Order Separately
NMO3E800B	5/8 over 1/4 λ	806-866	5.4	13.5	200	Black	Order Separately
NMO3E825B	5/8 over 1/4 λ	824-896	5.4	13.5	200	Black	Order Separately
NMO3E900B	5/8 over 1/4 λ	890-960	5.4	13.5	200	Black	Order Separately
NMO700	5/8 over 1/2 λ	740-806	5.6	12.75	200	Stainless	Order Separately
NM0770B	5/8 over 1/2 λ	758-870	5	17.3	200	Black	Order Separately
NM0770	5/8 over 1/2 λ	758-870	5	17.3	200	Stainless	Order Separately
NMO800	5/8 over 1/2 λ	806-866	5.6	12.75	200	Stainless	Order Separately
NMO825	5/8 over 1/2 λ	824-896	5.6	12.75	200	Stainless	Order Separately
NMO900	5/8 over 1/2 λ	890-960	5.6	12.75	200	Stainless	Order Separately
NMO800B	5/8 over 1/2 λ	806-866	5.6	12.75	200	Black	Order Separately
NMO825B	5/8 over 1/2 λ	824-896	5.6	12.75	200	Black	Order Separately
NMO900B	5/8 over 1/2 λ	890-960	5.6	12.75	200	Black	Order Separately
NMO5T800B	5/8 over 5/8 over 1/4 λ	806-866	7.2	18	200	Black	Order Separately
NMO5T825B	5/8 over 5/8 over 1/4 λ	824-896	7.2	18	200	Black	Order Separately
NMO5T900B*	5/8 over 5/8 over 1/4 λ	890-960	7.2	18	200	Black	Order Separately
NMO5E825B	5/8 over 5/8 over 1/4 λ	824-896	7.2	19	200	Black	Order Separately
NMO5E900B	5/8 over 5/8 over 1/4 λ	890-960	7.2	19	200	Black	Order Separately
Q800	1/4 λ	806-866	2	3.5	200	Stainless	Order Separately
Q900	1/4 λ	890-960	2	3.5	200	Stainless	Order Separately

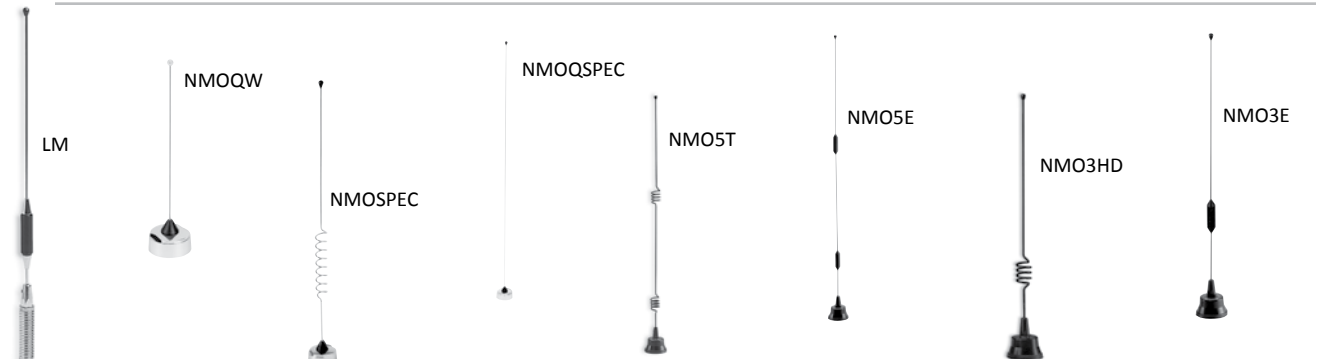

The most commonly used cable assembly/mount is the NMOKHFUD (27 MHz to 6 GHz) with 17' of UD (RG-58/U Dual Shield).



700/800/900/1850 MHz COILS/WHIPS (CONTINUED)

Model	Type	Frequency (MHz)	Gain (dBi)	Max Height (in)	Power Rating (Watts)	Whip Color	Cable Assembly	Conn
NMOC/P3E	5/8 over 1/4 λ	824-960 1850-1990	4	4.7	10	Black	Order Separately	
NMOC/P3EUD	5/8 over 1/4 λ	824-960 1850-1990	4	4.7	10	Black	17' RG-58/U	No Conn
NMOC/P3EUDFME	5/8 over 1/4 λ	824-960 1850-1990	4	4.7	10	Black	17' RG-58/U	FME
NMOC/P3EUDMPL	5/8 over 1/4 λ	824-960 1850-1990	4	4.7	10	Black	17' RG-58/U	MPL
NMOC/P3EUDSMA	5/8 over 1/4 λ	824-960 1850-1990	4	4.7	10	Black	17' RG-58/U	SMA
NMOC/P3EUDTNC	5/8 over 1/4 λ	824-960 1850-1990	4	4.7	10	Black	17' RG-58/U	TNC
NMOC/P3E770	5/8 over 1/4 λ	758-870	4	4.8	40	Black	Order Separately	TNC



NMOC/P3E



KG3E



KGI

700/800/900/1850 MHz GLASS MOUNT

Optimum glass thickness 0.138" through 0.158"

Model	Type	Frequency (MHz)	Gain (dBi)	Height (in)	Rating (Watts)	Whip Color	Cable Assembly	Connector
KGI768	1/4 λ	758-896	2	-	60	Black	14' RG-58/U	No Conn
KGI825	1/4 λ Dipole	806-896	2		60	Black	14' RG-58/U	No Conn
KG3E770	5/8 over 1/2 λ	758-896	5.14	-	60	Black	14' RG-58/U	No Conn
KG3E825UD	5/8 over 1/2 λ	806-896	5.14	13	60	Black	14' RG-58/U	No Conn
KG3E825UDFME	5/8 over 1/2 λ	806-896	5.14	13	60	Black	14' RG-58/U	FME
KG3E825UDMPL	5/8 over 1/2 λ	806-896	5.14	13	60	Black	14' RG-58/U	MPL
KG3E825UDTNC	5/8 over 1/2 λ	806-896	5.14	13	60	Black	14' RG-58/U	TNC
KG3E900UD	5/8 over 1/2 λ	890-960	5.14	13	60	Black	14' RG-58/U	No Conn
KG3E900UDFME	5/8 over 1/2 λ	890-960	5.14	13	60	Black	14' RG-58/U	FME
KG3E900UDMPL	5/8 over 1/2 λ	890-960	5.14	13	60	Black	14' RG-58/U	MPL
KG3E825O/S	5/8 over 1/2 λ	806-896	5.14	13	60	Black	Outside Coupler Only	
KG3E900O/S	5/8 over 1/2 λ	890-960	5.14	13	60	Black	Outside Coupler Only	
KGC/P3EUD	Cellular: Collinear PCS: 5/8 over 5/8 over 1/2 λ	824-896 1850-1990	5.14 5.14	13	7	Black	15' RB-58/U	No Conn
KGC/P3EUDFME	Cellular: Collinear PCS: 5/8 over 5/8 over 1/2 λ	824-896 1850-1990	5.14 5.14	13	7	Black	15' RB-58/U	FME
KG3E768UD	5/8 over 1/2 λ	764-869	5.14	14	60	Black	14' RG-58/U	



700/800/900/1850 MHz NMO MOUNT LOW PROFILE

Model	Frequency (MHz)	Gain (dBi)	Size H x DIA (in)	Power Rating (Watts)	Color	Cable Assembly
*LP78NMO**	740-960	4	1.5 x 4.5	100	Black	Order Separately
*LP800NMO**	806-960	2	1.5 x 4.5	100	Black	Order Separately
*LP800NMOW**	806-960	2	1.5 x 4.5	100	White	Order Separately
*LPT700/800NMO**	740-866	2	3.25 x 1.5	100	Black	Order Separately
*LPT800/900NMO**	806-960	2	3.25 x 1.5	100	Black	Order Separately
*LPT825/19NMOHF**	806-960 1710-2170 2400	3 3 4	3 x 1.75	45	Black	Order Separately Requires NMOHF Mount
SLPT698/960NMO***	698-960	4.5	3 x 1.5	45	Black	Order Separately
SLPT698/2170NMOHF***	698-960 1710-2170 2400-2700	4.5 5.6 4	3 x 1.75	45	Black	Order Separately Requires NMOHF Mount
ICEFINLNMHOHF***	698-2700	3	3 x 1.5	30	Transparent	Order Separately
ICEFIN698/960NMO ***	750-960	3	3 x 1.5	30	Transparent	Order Separately
ICEFIN806NMO***	806-960	2.9	3 x 1.5	35	Transparent	Order Separately

ICEFIN698-960NMO



LP



LPT



SLPT NMO



700/800/900/1850 MHz DIRECT MOUNTS

Model	Type	Frequency (MHz)	Gain (dBi)	Size (in)	Power Rating (Watts)	Color	Cable Assembly	Connector
*LP800**	Low Profile	806-960	2	1.25H x 5.25D	100	Black	17' RG-58/U	No Conn
LPT698/2700DMN		698-960 1710-2170 2300-2700	3.1 4.4 5	1.6 x 4.2		Black	Order Separately	N Female
*OM800UD	5/8 over 1/2 λ	806-866	3.2	15.5 H	60	Black	14' RG-58/U	No Conn
*OM800UDMPL	5/8 over 1/2 λ	806-866	3.2	15.5 H	60	Black	14' RG-58/U	MPL
*OM800UDTNC	5/8 over 1/2 λ	806-866	3.2	15.5 H	60	Black	14' RG-58/U	TNC
*OM825UD	5/8 over 1/2 λ	824-896	3.2	15.5 H	60	Black	14' RG-58/U	No Conn
*OM825UDMPL	5/8 over 1/2 λ	824-896	3.2	15.5 H	60	Black	14' RG-58/U	MPL
*OM825UDTNC	5/8 over 1/2 λ	824-896	3.2	15.5 H	60	Black	14' RG-58/U	TNC
*OM900UD	5/8 over 1/2 λ	890-960	3.2	15.5 H	60	Black	14' RG-58/U	No Conn
SLPT698/869DMN**	Low Profile	698-869	4.5	3 x 1.5	45	Black	Order Separately	N Female
SLPT806DMN***	Low Profile	806-960	4.5	3 x 1.5	45	Black	Order Separately	N Female
SLPT698/2170DMN***	Low Profile	Cellular: 698-960 PCS: 1710-2170 ISM: 2400-2700	4.5 5.6 4	3 x 1.75	45	Black	Order Separately	N Female
***ICEFIN698/869DMN	ICEFIN	698-869	2.6	3 x 1.5	15	Transparent	Order Separately	N Female
LP800SMA	Low Profile	806-960	2	1.25H x 5.25D	100	Black	17' RG-58/U	SMA
LP800WSMAF	Low Profile	806-960	2	1.25H x 5.25D	100	White	2.5' RG58/U	SMA Female
LP800SMA3	Low Profile	806-960	2	1.25H x 5.25D	100	Black	3' RG58/U	SMA

ICEFIN806DMN



OM



SLPT DM



LP Direct Mount



LPT



The most commonly used cable assembly/mount is the NMOKHFUD (27 MHz to 6 GHz) with 17' of UD (RG-58/U Dual Shield).



700/800/900/1850 MHz MAGNETIC MOUNTS

Model	Type	Frequency (MHz)	Gain (dBi)	Max Height (in)	Power Rating (Watts)	Whip Color	Cable Assembly	Connector
MS3E800FME	5/8 over 1/2 λ	806-896	5.6	13	60	Black	12' RG-58A/U	FME
MS3E800MPL	5/8 over 1/2 λ	806-896	5.6	13	60	Black	12' RG-58A/U	MPL
MS3E800TNC	5/8 over 1/2 λ	806-896	5.6	13	60	Black	12' RG-58A/U	TNC
MS3E900MPL	5/8 over 1/2 λ	890-960	5.6	13	60	Black	12' RG-58A/U	MPL
MS3E900TNC	5/8 over 1/2 λ	890-960	5.6	13	60	Black	12' RG-58A/U	TNC
MS3E900SMA	5/8 over 1/2 λ	890-960	5.6	13	40	Black	12' RG-58A/U	SMA
MM5E900BNC	5/8 over 5/8 over 1/4 λ	890-960	7.12	16.5	60	Black	12' RG-58A/U	BNC
MM5T900SMA	5/8 over 5/8 over 1/4 λ	890-960	7.2	18	60	Black	12' RG-58A/U	SMA
MM5T900SMARP	5/8 over 5/8 over 1/4 λ	890-960	7.2	18	60	Black	12' RG-58A/U	SMA RP
MSU800FME	1/2 λ	806-896	2	4	40	Black	12' RG-58A/U	FME
MSU900FME	1/2 λ	890-960	2	4	40	Black	12' RG-58A/U	FME
MMC/P3EFME	5/8 over 1/4 λ	824-960 1850-1990	4 4	5	7	Black	12' RG-58/U	FME
MMC/P3EMPL	5/8 over 1/4 λ	824-960 1850-1990	4 4	5	7	Black	12' RG-58/U	MPL
MMC/P3ETNC	5/8 over 1/4 λ	824-960 1850-1990	4 4	5	7	Black	12' RG-58/U	TNC
MMC/P3ESMA	5/8 over 1/4 λ	824-960 1850-1990	4 4	5	7	Black	12' RG-58/U	SMA

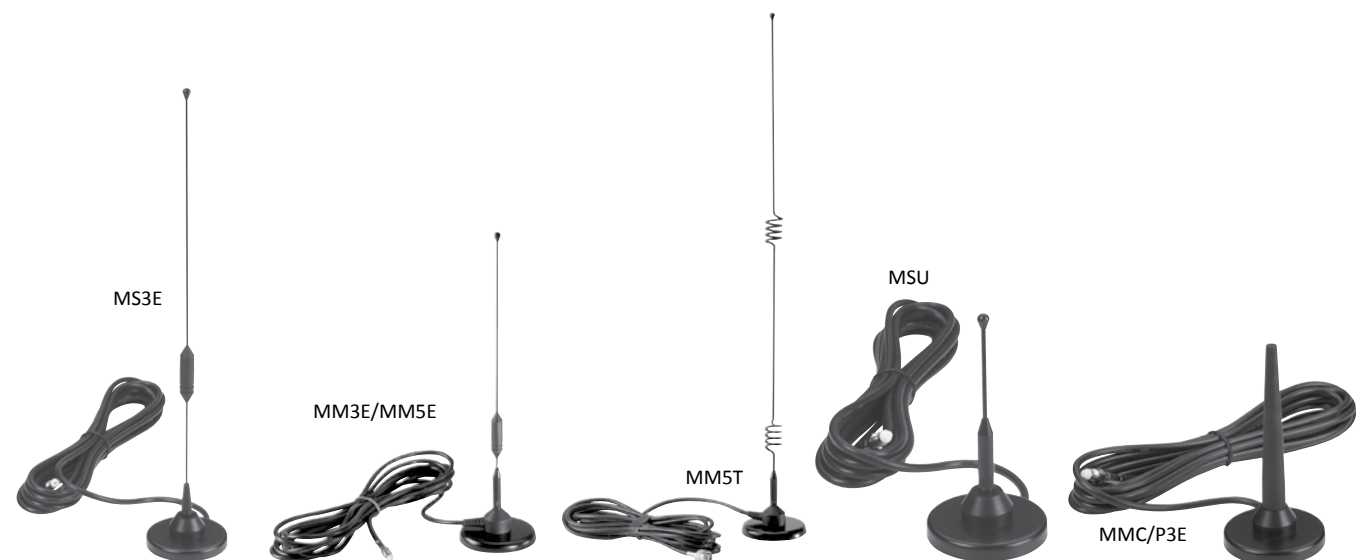

GPS DIRECT MOUNTS

GPS single band direct mount antennas have the following specifications:

Frequency: 1575.4
Gain: 5 dBic
LNA Gain: 28 dB ± 2 dB
Pattern: Hemispherical
Mounting: Direct Feed 5/8" hole
Polarization: Right-Hand Circular
Coax: 17' RG-174
Voltage: 5V DC
Color: Black
Size: .7" H x 2.5" Dia

Model	Connector	Color
GPSDM02	MCX	Black
GPSDM04	MMCX	Black
GPSDM06	SMB	Black
GPSDM08	SMA	Black



GLASS MOUNT

GPS glass mount single band antennas have the following specifications:

Frequency: 1575.4 MHz
Pattern: Hemispherical
Polarization: Right-Hand Circular
Mounting: Double Sided Tape
Gain: 1.5 dBi
LNA Gain: 26 dB ± 2 dB
VSWR: 1.5:1
Voltage: 3V or 5V DC

Model	Size H x L x W (in)	Color	Cable	Connector
*GPSGMSMA	.2 x 3 x 1.2	Black	16.4' RG-174	SMA
*GPSGMSMB	.2 x 3 x 1.2	Black	16.4' RG-174	SMB



* IP65 RATED

GPS LOW PROFILE SINGLE BAND

GPS low profile single band antennas have the following specifications:

Frequency: 1575.4 MHz
Pattern: Hemispherical
Polarization: Right-Hand Circular
Mounting: NMO Mount
Gain: 5 dBic
LNA Gain: 28 dB ± 2 dB
VSWR: 2.0:1
Voltage: 5V DC

Model	Size H x D (in)	Color	Cable	Connector
GPSNMO01	1.3 x 2.9	White	Order Separately	Order Separately
GPSNMO02	1.3 x 2.9	Black	Order Separately	Order Separately
GPSNMO07	1.3 x 2.9	White	17' RG-58/U	SMB
GPSNMO08	1.3 x 2.9	Black	17' RG-58/U	SMB
GPSNMO09	1.3 x 2.9	White	17' RG-58/U	SMA
GPSNMO10	1.3 x 2.9	Black	17' RG-58/U	SMA



GPS LOW PROFILE



GPS0015

GPS TIMING ANTENNA

Model	Frequency (MHz)	LNA Gain (± 2 dB)	Dimensions H x W (in)	Polarization	Voltage	Color	Mounting	Connector
GPS0015	1575.42 ± 1.023	25	4 x 4.5	RHCP	4V-15V DC	White	Bracket	N Male

See also GPSDM26B0500 on page 56 for a lower cost alternative



*MADE IN THE USA
ALL PARST ARE IP65 RATED



*MADE IN THE USA
**IP65 RATED
***IP67 RATED

GPS COMBI WHIP DIRECT MOUNTS



GPS combi whip direct mount antennas have the following specifications:

LNA Gain: 26 dB ± 2 dB
Polarization: Right-Hand Circular /Vertical
Mounting: Direct Feed 5/8" hole
Color: Black

Pattern: Hemispherical / Omni
Coax: 16.4' RG-174 / 16.4' RG-174
Voltage: 5V DC
Base Size: 2" W x 2.3" L x 0.7" H

Model	Frequency (MHz)	Gain (dBi/dBic)	Whip Length (In)	Connector
GPSCW1502	136-174 / 1575.42	2.14/5	22	SMA/SMB
GPSCW4501	406-512 / 1575.42	2.14/5	6.25	SMA/SMA
GPSCW4502	406-512 / 1575.42	2.14/5	6.25	SMA/SMB
GPSCW3E8001	806-896 / 1575.42	5/5	11.5	SMA/SMA
GPSCW3E8003	806-896 / 1575.42	5/5	11.5	FME/SMA

GPS & CELLULAR COMBO DIRECT MOUNT

Direct mount antennas have the following specifications:

Frequency: 824-960 / 1710-2170 / 1575.4 MHz
VSWR: <2.0:1
Gain: 2 dBi / 2 dBi / 5 dBi
LNA Gain: 26 dB ± 2 dB
Pattern: Omni / Omni / Hemispherical
Voltage: 3V or 5V DC
Polarization: Vertical / Vertical / Right-Hand Circular
Coax: 16.4' RG-174 / 16.4' RG-174
Mounting: Direct Feed 3/4" hole
Magnetic Mount Option

Model	Size L x W x D (In)	Color	Connector
*GPSCP00	7.6 x 3.4 x 1.3	Black	TNC/SMA
*GPSCP01	7.6 x 3.4 x 1.3	White	No Conn
*GPSCP02	7.6 x 3.4 x 1.3	Black	No Conn/SMA
*GPSCP03	7.6 x 3.4 x 1.3	White	No Conn/SMA
*GPSCP04	7.6 x 3.4 x 1.3	Black	No Conn/SMB
*GPSCP05	7.6 x 3.4 x 1.3	White	No Conn/SMB
*GPSCP06	7.6 x 3.4 x 1.3	Black	SMA/SMA
*GPSCO07	7.6 x 3.4 x 1.3	White	SMA/SMA
*GPSCP08	7.6 x 3.4 x 1.3	Black	MPL/SMA
*GPSCP09	7.6 x 3.4 x 1.3	White	MPL/SMA
*GPSCP10	7.6 x 3.4 x 1.3	Black	TNC/BNC
*GPSCWCP00	3.9 x 2.3 x 3.2	Black	TNC/SMA
*GPSCWCP01	3.9 x 2.3 x 3.2	Black	No Conn/SMA
*GPSCWCP02	3.9 x 2.3 x 3.2	Black	No Conn/SMB
*GPSCWCP03	3.9 x 2.3 x 3.2	Black	SMA/MPL
*GPSCWCP04	3.9 x 2.3 x 3.2	Black	SMA/SMA
*GPSCWCP05	3.9 x 2.3 x 3.2	Black	TNC/TNC
*GPSCPMM00	7.6 x 3.4 x 1.3	Black	TNC/SMA (Mag Mount)
*GPSCPMM02	7.6 x 3.4 x 1.3	Black	No Conn/SMA (Mag Mount)

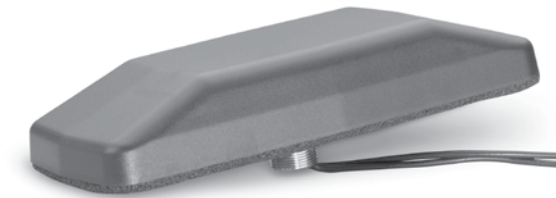

GPSCP



GPS Multi Band Mag Mount



GPSCW

GPS MAGNETIC MOUNT

Gain: 4dBic
Polarization: Right Hand Circular
Coax: LMR195 equivalent
Voltage: 3-5V
Color: Gray (PANTONE 427)
Pattern: Hemispherical

Mounting: Direct Feed 5/8" hole
IP Rating: IP67
Size: .87" (H) x 1.97" (Dia)

Model	Frequency	LNA Gain	Cable Length	Connector
GPSDM26B0500	1575.42	25±2dB	19.68" (500mm)	SMA
GNSSDM26B0500	1561/1575/1602	30±2dB	19.68" (500mm)	SMA



GPSDM26B0500

GPS DIRECT MOUNT

NMOHFGPS mount have the following specifications:

Frequency: 1575.4 - 1576.4 MHz
Polarization: Right-Hand Circular / Vertical
Cable: 16.4' RG-174 (GPS)
16.4' RG-58 (NMOHF)
Size: .5 x 2 x 4.5
Mounting: 5/8" Hole

Gain: 5 dBic
LNA Gain: 26 dB ± 2 dB
VSWR: Less than 2:1
Voltage: 3V or 5V DC
Color: Black

Model	Connectors (mount / GPS)	Color
*NMOHFGPSFMENOCOON**	FME/No Connector	Black
*NMOHFGPSFMESMA**	FME/SMA	Black
*NMOHFGPSNOCONN**	No Connectors	Black
*NMOHFGPSSMASMA**	SMA/SMA	Black

NOTE: Specifications listed refer to GPS performance. Additional antenna specifications are dependent on the antenna mounted on the NMO side.



GPS MAGNETIC MOUNT

GPS single band magnetic mount antennas have the following specifications:

Frequency: 1575.4 MHz
Pattern: Hemispherical
Polarization: Right-Hand Circular
Cable: 17' RG-174

Gain: 5 dBic
LNA Gain: 26 dB ± 2 dB
VSWR: Less than 2:1
Voltage: 5V DC

Model	Size H x L x W (In)	Color	Connector
GPS0002	0.5 x 1.75 x 1.5	Black	MCX
GPS0006	0.5 x 1.75 x 1.5	Black	SMB
GPS0008	0.5 x 1.75 x 1.5	Black	No Conn
GPS0010	0.5 x 1.75 x 1.5	Black	SMA
GPS0012	0.5 x 1.75 x 1.5	Black	BNC



GPS Single Band Mag Mount

Contact factory for upcoming GNSS models covering GPS, Glonass, Beidou/Compass and Galileo



W1919



JAGUAR GPSLPMB

GPS & CELLULAR COMBO : STEALTH BLADES WITH ADHESIVE MOUNT

Dimensions: 5.4" (L) x 1.5"(W) x 0.6" (H) / 136mm(L) x 38mm(W) x 14mm(H)
Mounting: Adhesive Tape
IP Rating : IP67

MODEL	NUMBER OF CABLES	APPLICATION	FREQUENCY (MHZ)	VSWR	PEAK GAIN (DBI, AVG)	DIMENSION (L X W X H)	COAX	CONNECTOR
GPSSB800/2170FS	2	3G	806-960/ 1710-2170	<2.5:1	0	5.4" x 1.5" x 0.6" 136mm x 38mm x 15mm	16.4' RG-174	FME (F)
		GPS	1575.42	<2:1	LNA gain:30dB, NF:< 2.4dB, DC power: 3-5V			SMA (m)
GPSSB800/2170SS	2	3G	806-960/ 1710-2170	<2.5:1	0	5.4" x 1.5" x 0.6" 136mm x 38mm x 15mm	16.4' RG-174	SMA (m)
		GPS	1575.42	<2:1	LNA gain:30dB, NF:< 2.4dB, DC power: 3-5V			SMA (m)
W4120GNSS5000	2	3G	806-960/ 1710-2170	<2.5:1	1.7(LB) 2.9(HB)	5.4" x 1.5" x 0.6" 136mm x 38mm x 15mm	16.4' RG-174	SMA (m)
		GNSS	1559-1606	<2:1	LNA gain:30dB, NF:< 2.4dB, DC power: 3-5V			SMA (m)

Note:
 1)* of equivalent cable.

JAGUAR SERIES - MULTIBAND VEHICULAR ANTENNAS

Please contact factory for E-Mark certification
Mounting: Adhesive Mount
IP Rating : IP67

MODEL	NUMBER OF CABLES	APPLICATION	FREQUENCY (MHZ)	PEAK GAIN (DBI)	DIMENSION (L X W X H)	COAX	CONNECTOR
GPSLPMB401	4	LTE 1	698-960/ 1710-2690	4.4 (LB) 5.4 (HB)	5.7" x 5.3" x 0.95" 145mm x 135mm x 24mm	10' LMR195*	SMA (m)
		LTE 2	698-960/ 1710-2690	4.4 (LB) 5.4 (HB)		10' LMR195*	SMA (m)
		WIFI 1	2400-2500/ 4900-5950	4.5 (LB) 6.7 (HB)		10' LMR195*	RP-SMA (m)
		GNSS	1559-1606	LNA gain:30dB, NF:< 2.4dB, DC power: 3-5V		10' RG174	SMA (m)
LPMB401	4	LTE 1	698-960/ 1710-2690	2 (LB) 4.4 (HB)	5.7" x 5.3" x 0.95" 145mm x 135mm x 24mm	10' LMR195*	SMA (m)
		LTE 2	698-960/ 1710-2690	2 (LB) 4.4 (HB)		10' LMR195*	SMA (m)
		WIFI 1	2400-2500/ 4900-5950	3.5 (LB) 4.7 (HB)		10' LMR195*	RP-SMA (m)
		WIFI 2	2400-2500/ 4900-5950	3.5 (LB) 4.7 (HB)		10' LMR195*	RP-SMA (m)
W1919	2	LTE1 1	698-960/ 1710-2690/ 3400-3800	-0.4 @698-960/ 1.7 @1710-2690/ 1.7 @ 3400-3800	3.08" x 3.08" x 1.2" 78mm x 78mm x 30mm	10' RG174	SMA (m)
		LTE 2	698-960/ 1710-2690/ 3400-3800	-0.4 @698-960/ 1.7 @1710-2690/ 1.7 @ 3400-3800		10' RG174	SMA (m)

Note:
 1) LPMB4BRACKETMM is a magnetic mounting base option for Jaguar Series antenna while LPMB4BRACKETAM is a adhesive mounting base option.
 2) Frequency details for GNSS: 1561.098MHz±2.06/1575.42MHz±1.023/1602.5625MHz±4
 3) * of equivalent cable.



DISC W4165

DISC SERIES - MULTIBAND ANTENNAS

Please contact factory for E-Mark certification
Options up to 2 leads; including 3G (or ISM), or WLAN or GNSS includes GPS, Glonass, Beidou/Compass, Galileo

Dimensions: (Direct Mount) 3.95"(D) x 1.37" (H) / 100mm(D) x 34.8mm (H)
 (Magnetic Mount) 3.97"(D) x 1.67" (H) / 100.8mm(D) x 43mm(H)
Mounting: Direct Mount , 3/4" mounting hole (19mm)

Coaxial Cable Type: RG-174, 2x
IP Rating: IP67

MODEL		NUMBER OF CABLES	APPLICATION	FREQUENCY (MHZ)	VSWR	PEAK GAIN (DBI, AVG)	CABLE LENGTH (INCHES)	CONNECTOR
DIRECT MOUNT	MAGNETIC MOUNT							
W4165	W4165MM	2	3G / GNSS	824-960/1710-2170 1559-1610	<2 :1	4 (LB) 4.5 (UB) *See below for GNSS spec	13.2'	SMA(m)/SMA(m)
W4165AI	W4165MMAI						5'	TNC(m)/RP-TNC (m)
W4165SMA5	W4165MMSMA5						5'	SMA(m)/SMA(m)
W4165RPSMA10	W4165MMRPSMA10						10'	RP-SMA (m)/RP-SMA(m)
W4156	N/A	2	3G	824-960/1710-2170	<2 :1	2.5 (LB) 4 (UB)	13.2'	SMA(m)
			WLAN	2400-2500/4900-5900	<2 :1	4 (LB) 4.5 (UB)		SMA(m)

Note: 1) Frequency details for GNSS: 1561.098MHz±2.06/1575.42MHz±1.023/1602.5625MHz±4'.
 LNA Gain : 30dB, NF: < 2.4dB, DC power : 3-5V



FIN SERIES - MULTIBAND VEHICULAR ANTENNAS

Please contact factory for E-Mark certification
Options up to 3 leads; including 3G (or ISM), or WLAN or GNSS includes GPS, Glonass, Beidou/Compass, Galileo

Dimensions: 4.26"(D) x 3.48" (H) / 108mm(D) x 88.3mm (H)
Mounting: Direct Mount , 3/4" mounting hole (19mm)
IP Rating : IP67

MODEL	NUMBER OF CABLES	APPLICATION	FREQUENCY (MHZ)	VSWR	PEAK GAIN (DBI, AVG)	COAX CABLE	CONNECTOR
GPSDM700/5800GGT (Black Color)	3	LTE	698-960/1710-2700	<2.5:1	3 (LB) 4.5(HB)	17' RG58	SMA(m)
GPSDMW700/5800GGT (White Color)		WLAN	2400-2485/5150-5825	<2:1	4.1 (UB) 5.9 (HB)	17' RG58	RP-SMA(m)
		GPS	1575.42	<2:1	LNA gain:30dB, NF:< 2.4dB, DC power: 3-5V	17' RG174	SMA(m)
GPSDM700/5800SSS (Black Color)	3	LTE	698-960/1710-2700	<2.5:1	3 (LB) 4.5(HB)	17' RG58	SMA(m)
GPSDMW700/5800SSS (White Color)		WLAN	2400-2485/5150-5825	<2:1	4.1 (UB) 5.9 (HB)	17' RG58	SMA(m)
		GPS	1575.42	<2:1	LNA gain:30dB, NF:< 2.4dB, DC power: 3-5V	17' RG174	SMA(m)
GNSSDM700/5800SSS (Black Color)	3	LTE	698-960/1710-2700	<2.5:1	3 (LB) 4.5(HB)	17' RG58	SMA(m)
		WLAN	2400-2485/5150-5825	<2:1	4.1 (UB) 5.9 (HB)	17' RG58	SMA(m)
		GNSS	1559-1606	<2:1	LNA gain:30dB, NF:< 2.4dB, DC power: 3-5V	17' RG174	SMA(m)

Note: 1)Frequency details for GNSS: 1561.098MHz±2.06/1575.42MHz±1.023/1602.5625MHz±4

RAZORBACK SERIES

Please contact factory for E-Mark certification
Options up to 6 leads; including MIMO LTE(2x), MIMO WIFI(3x), GPS/GNSS
GNSS includes GPS, Glonass, Beidou/Compass, Galileo

Dimension: (Direct & Adhesive Mount)7.6"(L) x 3.4"(W) x 3.6"(H) / 195mm(L) x 88mm(W) x 92mm(H)
 (Magnetic Mount)7.6"(L) x 3.5"(W) x 3.7"(H) / 195mm(L) x 89mm(W) x 94mm(H)

Mounting: Direct Mount & Adhesive Mount, 7/8" mounting hole (M22 nut)

IP Rating : IP67



RAZ4211XDM

MODEL			NUMBER OF CABLES	APPLICATION	FREQUENCY(MHZ)	VSWR	ISOLATION	PEAK GAIN(DBI)	CABLE	CONNECTOR
DIRECT MOUNT	MAGNETIC MOUNT	ADHESIVE MOUNT								
RAZ62311DM (Black Color)	RAZ62311MM (Black Color)	RAZ62311AM (Black Color)	6	LTE1	644-960/ 1710-2700	< 2:1	<-13	4.6(LB) 4.9(UB)	17' LMR195*	SMA (m)
RAZ62312DM (White Color)	RAZ62312MM (White Color)	RAZ62312AM (White Color)		LTE2						SMA (m)
				WLAN 1	2400-2500/ 4900-5925	< 2:1	<-13	6 (LB) 6.6(UB)	17' LMR195*	RP-SMA(m)
				WLAN 2						RP-SMA(m)
				WLAN 3						RP-SMA(m)
				GNSS	1559-1610	< 2:1	LNA gain:30dB, NF:<2.4dB, DC power: 3-5V		17'RG174	SMA
RAZ52211DM (Black Color)	RAZ52211MM (Black Color)	RAZ52211AM (Black Color)	5	LTE1	644-960/ 1710-2700	< 2:1	<-13	4.6(LB) 4.9(UB)	17' LMR195*	SMA (m)
RAZ52212DM (White Color)	RAZ52212MM (White Color)	RAZ52212AM (White Color)		LTE2						SMA (m)
				WLAN 1	2400-2500/ 4900-5925	< 2:1	<-13	6 (LB) 6.6(UB)	17' LMR195*	RP-SMA(m)
				WLAN 2						RP-SMA(m)
			GNSS	1559-1610	< 2:1	LNA gain:30dB, NF:<2.4dB, DC power: 3-5V		17'RG174	SMA	
RAZ42111DM (Black Color)	RAZ42111MM (Black Color)	RAZ42111AM (Black Color)	4	LTE1	644-960/ 1710-2700	< 2:1	<-13	4.6(LB) 4.9(UB)	17' LMR195*	SMA (m)
RAZ42112DM (White Color)	RAZ42112MM (White Color)	RAZ42112AM (White Color)		LTE2						SMA (m)
				WLAN	2400-2500/ 4900-5925	< 2:1	<-13	6 (LB) 6.6(UB)	17' LMR195*	RP-SMA(m)
				GNSS	1559-1610	< 2:1	LNA gain:30dB, NF:<2.4dB, DC power: 3-5V		17'RG174	SMA
RAZ32011DM (Black Color)	RAZ32011MM (Black Color)	RAZ32011AM (Black Color)	3	LTE1	644-960/ 1710-2700	< 2:1	<-13	4.6(LB) 4.9(UB)	17' LMR195*	SMA (m)
RAZ32012DM (White Color)	RAZ32012MM (White Color)	RAZ32012AM (White Color)		LTE2						SMA (m)
				GNSS	1559-1610	< 2:1	LNA gain:30dB, NF:<2.4dB, DC power: 3-5V		17'RG174	SMA



ARMADILLO SERIES

Please contact factory for E-Mark certification
Options up to 6 leads; including MIMO LTE(2x), MIMO WIFI(3x), GPS/GNSS
GNSS includes GPS, Glonass, Beidou/Compass, Galileo

Dimension: 6.5”(L) x 6”(W) x 3”(H) /
 164.5mm(L) x 151.9mm(W) x 76mm(H)
Mounting: Direct Mount, 7/8” mounting hole (M22 nut)
IP Rating: IP67

MODEL			NUMBER OF CABLES	APPLICATION	FREQUENCY(MHZ)	VSWR	PEAK GAIN(DBI)**	COAXIAL CABLE	CONN.
DIRECT MOUNT	MAGNETIC MOUNT	ADHESIVE MOUNT							
ARM62311DM (Black Color)	ARM62311MM (Black Color)	ARM62311AM (Black Color)	6	LTE1	698-960/ 1710-2700	< 2.5:1	4.9(LB) 5.3(UB)	17' LMR195*	SMA (m)
				LTE2					SMA (m)
ARM62312DM (White Color)	ARM62312MM (White Color)	ARM62312AM (White Color)		WLAN 1	2400-2500/ 5150-5900	< 2:1	4.6 (LB) 6.6(UB)	17'LMR195*	RP-SMA(m)
				WLAN 2					RP-SMA(m)
				WLAN 3					RP-SMA(m)
				GNSS	1559-1610	< 2 : 1	LNA gain:30dB, NF:<2.4dB, DC power: 3-5V		SMA
ARM52211DM (Black Color)	ARM52211MM (Black Color)	ARM52211AM (Black Color)	5	LTE1	698-960/ 1710-2700	< 2.5:1	4.9(LB) 5.3(UB)	17' LMR195*	SMA (m)
				LTE2					SMA (m)
ARM52212DM (White Color)	ARM52212MM (White Color)	ARM52212AM (White Color)		WLAN 1	2400-2500/ 5150-5900	< 2:1	4.6 (LB) 6.6(UB)	17'LMR195*	RP-SMA(m)
				WLAN 2					RP-SMA(m)
				GNSS					1559-1610
ARM42111DM (Black Color)	ARM42111MM (Black Color)	ARM42111AM (Black Color)	4	LTE1	698-960/ 1710-2700	< 2.5:1	4.9(LB) 5.3(UB)	17' LMR195*	SMA (m)
				LTE2					SMA (m)
ARM42112DM (White Color)	ARM42112MM (White Color)	ARM42112AM (White Color)		WLAN	2400-2500/ 5150-5900	< 2:1	4.6 (LB) 6.6(UB)	17'LMR195*	RP-SMA(m)
				GNSS	1559-1610	< 2 : 1	LNA gain:30dB, NF:<2.4dB, DC power: 3-5V		SMA
ARM32011DM (Black Color)	N/A	ARM32011AM (Black Color)	3	LTE1	698-960/ 1710-2700	< 2.5:1	4.9(LB) 5.3(UB)	17' LMR195*	SMA (m)
									LTE2
ARM32012DM (White Color)		ARM32012AM (White Color)		GNSS	1559-1610	< 2 : 1	LNA gain:30dB, NF:<2.4dB, DC power: 3-5V		SMA
ARM21011DM (Black Color)	N/A	N/A	2	LTE	698-960/ 1710-2700	< 2.5:1	4.9(LB) 5.3(UB)	17' LMR195*	SMA (m)
ARM21012DM (White Color)						GNSS	1564-1610	< 2 : 1	LNA gain:30dB, NF:<2.4dB, DC power: 3-5V

Note:
 1)Frequency details for GNSS: 1561.098MHz±2.06/1575.42MHz±1.023/1602.5625MHz±4
 2) *or equivalent cable
 3)**Antenna measured with 6 inch cable. Attenuation of cable assembly with 17' coax is 3.6dB.

MULTI-BAND DATA ANTENNAS



GPSMB501



GPSMB Panther (White)



GPSMB301



Antenna variant comply to railroad standards are available!

PANTHER SERIES

Please contact factory for E-Mark certification
Options up to 6 leads; including MIMO LTE(2x), MIMO WIFI(3x), GPS/GNSS
GNSS includes GPS, Glonass, Beidou/Compass, Galileo

Dimension: 6.5"(L) x 6"(W) x 3"(H) /
 164.5mm(L) x 151.9mm(W) x 76mm(H)

Mounting: Direct Mount, 7/8" mounting hole (M22 nut)

IP Rating : IP67

MODEL	NUMBER OF CABLES	APPLICATION	FREQUENCY(MHZ)	VSWR	ISOLATION	PEAK GAIN(DBI)	CABLE	CONN.
PAN62311DM (Black Color) PAN62312DM (White Color)	6	LTE1	698-960/ 1695-2700/ 2900-3600	< 1.5:1	-15	4(LB) 5(UB)	17'RG-58	SMA (m)
		LTE2						SMA (m)
		WLAN 1	2400-2500/ 4900-5900	< 1.5:1	-25	4.5 (LB) 5(UB)	17'RG-58	RP-SMA(m)
		WLAN 2						RP-SMA(m)
		WLAN 3						RP-SMA(m)
GNSS	1559-1610	< 2 : 1	LNA gain:30dB, NF:< 2.5dB, DC power: 3-5V		17'RG-174	SMA		
GPSMB501 (Black Color) GPSMB502 (White Color)	5	LTE1	698-960/ 1695-2700/ 2900-3600	< 1.5:1	-15	4(LB) 5(UB)	17'RG-58	SMA (m)
		LTE2						SMA (m)
		WLAN 1	2400-2500/ 4900-5900	< 1.5:1	-25	4.5 (LB) 5(UB)	17'RG-58	RP-SMA(m)
		WLAN 2						RP-SMA(m)
		GNSS	1559-1610	< 2 : 1	LNA gain:30dB, NF:< 2.5dB, DC power: 3-5V		17'RG-174	SMA
GPSMB401 (Black Color) GPSMB402 (White Color)	4	LTE1	698-960/ 1695-2700/ 2900-3600	< 1.5:1	-15	4(LB) 5(UB)	17'RG-58	SMA (m)
		LTE2						SMA (m)
		WLAN	2400-2500/ 4900-5900	< 1.5:1	N/A	4.5 (LB) 5(UB)	17'RG-58	RP-SMA(m)
		GNSS	1559-1610	< 2 : 1	LNA gain:30dB, NF:< 2.5dB, DC power: 3-5V		17'RG-174	SMA
GPSMB301 (Black Color) GPSMB302 (White Color)	3	LTE1	698-960/ 1695-2700/ 2900-3600	< 1.5:1	-15	6(LB) 5.5(UB)	17'RG-58	SMA (m)
		LTE2						SMA (m)
		GNSS	1559-1610	< 2 : 1	LNA gain:30dB, NF:< 2.5dB, DC power: 3-5V		17'RG-174	SMA

Note:

1)GPSMBMM is a magnetic mounting base option for Panther Series antenna.

2)Panther Series has models that are compliant with railroad standards EN50155, EN61373 and EN45545-2. Contact factory for more information.

3)Frequency details for GNSS: 1561.098MHz±2.06/1575.42MHz±1.023/1602.5625MHz±4



NOTE: All NMO mount antennas listed in this catalog section require the NMOHF-style (high frequency 27 MHz - 6 GHz) mount.

PUBLIC SAFETY AND WIFI BROADBAND ANTENNAS

Model	Type	Frequency (MHz)	Gain (dBi)	Max Height (In)	VSWR	Cable Assembly
EF2405NMO	Elevated Feed	2400-2500	5	16	<1.5:1	Order Separately
EF4905NMO	Elevated Feed	4900-5000	5	12	<1.5:1	Order Separately
NMO4E4900B	Elevated Feed	4900-5350	4	4.5	2:1	Order Separately
NMO4E5350B	Elevated Feed	5350-5925	4	4.5	2:1	Order Separately
NMO5E2400B	Collinear	2400-2500	2.95	8.5	1.5:1	Order Separately



EF



NMO4E



NMO5E



Through its rich history in the Larsen and LK brands, Pulse has over 50 years in the antenna business.

NOTE: All NMO mount antennas listed in this catalog section require the NMOHF-style (high frequency 27 MHz - 6 GHz) mount.

PUBLIC SAFETY 700/800; 2G/3G/4G LTE; WIFI; DSRC – LOW PROFILE

Model Black	Model White	Frequency (MHz)	Gain (dBi)	Mount	Size Hx DIA (in)	Power Rating (Watts) Black / White / ICEFIN
*LPT825/19NMOHF	N/A	Cellular: 806-960 PCS: 1710-2170 ISM: 2400	3 3 4	NMOHF	3 x 1.75	10 / 10 / NA
*LPT2400NMOHF	LPT2400NMOHFW	2400-2500	5	NMOHF	3 x 1.75	10 / 10 / NA
**SLPT698/2170NMOHF	SLPT698/2170NMOHFW	LTE: 698-960 PCS: 1710-2170 ISM: 2400-2700	4.5 5.6 4	NMOHF	3 x 1.75	40 / 40 / 30
**SLPT2400NMOHF	SLPT2400NMOHFW	2400-2500	4.3	NMOHF	2.6 x 1.5	35 / 35 / 30
**SLPT4900NMOHF	SLPT4900NMOHFW	4900-5900	5.5	NMOHF	2.6 x 1.5	35 / 35 / 30
**SLPT2400/5900NMOHF	SLPT245NMOHFW	2400-2500 4900-5900	4.3 5.5	NMOHF	2.6 x 1.5	35 / 35 / 30
**SLPT698/2170DMN	SLPT698/2170DMNW	LTE: 698-960 PCS: 1710-2170 ISM: 2400-2700	4.5 5.6 4	Direct (N Female)	3 x 1.75	40 / 40 / 35
**SLPT2400DMN	SLPT2400DMNW	2400-2500	4.3	Direct (N Female)	2.6 x 1.5	35 / 35 / 30
**SLPT4900DMN	SLPT4900DMNW	4900-5900	5.5	Direct (N Female)	2.6 x 1.5	35 / 35 / 30
SLPT2400/5900DMN	N/A	2400-2500 4900-6000	4.8 5.1	Direct (N Female)	2.6 x 1.5	45/45/ NA

ICEFIN698-960NMO



ICEFIN806DMN



SLPT NMO



SLPT DM



LPT



LTE MAGNETIC MOUNT

Model	Application	Frequency(MHz)	VSWR	Peak Gain (dBi, Avg)	Coax Cable	Connector
LPT698/3800MM	LTE, LTE Cat M1	"698-960/ 1710-3800"	<2:1	2	10' RG58	SMA (m)
LPT698/38MM200SMA					10' LMR200*	SMA (m)
LPT698/3800MMMCX					10' RG58	MMCX

Note: 1)* of equivalent cable.





LTE, 4G, BROADBAND RADOME OMNIS

Radome Enclosure: Pultruded Fiberglass (UV Protected)
VSWR: 2.0:1 **Power Rating:** 20 Watts
Ingress Protection: IP67 **Polarization:** Vertical
Suggested mounting brackets for N Female connectors are FB2BRACKET or FB3BRACKET. See Page 53 for FB brackets.

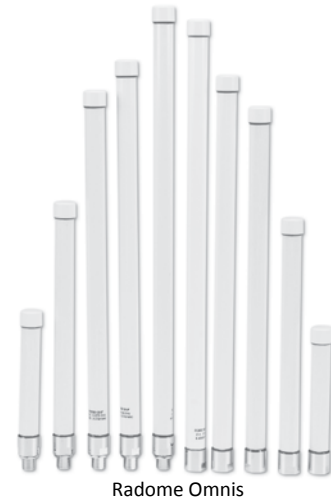

Model	Frequency (MHz)	Gain (dBi)	Length (In)	Connector
**W5067 ⁽¹⁾	698-960 1710-2170 2400-2700	0.7 1.0 2.0	9.1	N Female
RO17102NM ⁽²⁾	1710-2170	2	4.5	N Male
RO8605NFC ⁽³⁾	860 - 930	5.0	32	N Female
*RO2404NM	2400-2500	4	11.5	N Male
*RO2406NF	2400-2500	6	11.5	N Female
*RO2406NM	2400-2500	6	11.5	N Male
RO2408NF	2400-2500	8	20	N Female
RO2408NM	2400-2500	8	20	N Male
RO2408NFD (downtilt)	2400-2500	8	20	N Female
RO2408NMD (downtilt)	2400-2500	8	20	N Male
RO2408NFU (uptilt)	2400-2500	8	20	N Female
RO2408NMU (uptilt)	2400-2500	8	20	N Male
*RO2202NF	217-222	1.6	33	N Female
*RO4910NF	4940-4990	10	18	N Female
*RO4910NM	4940-4990	10	18	N Male
*RO5206NF	5150-5350	6	6.75	N Female
*RO5410NF	5470-5725	10	16.5	N Female
*RO5210NF	5150-5350	10	16.5	N Female
*RO5210NM	5150-5350	10	16.5	N Male
*RO5410NM	5470-5725	10	16.5	N Male
*RO5805NF	5150-5825	5	6.75	N Female
*RO5805NM	5150-5825	5	6.75	N Male
*RO5806NF	5725-5875	6	6.75	N Female
*RO5810NF	5725-5875	10	16.5	N Female
*RO5810NM	5725-5875	10	16.5	N Male
RO8063/21704NM	806-960	3	16.5	N Male
RO8063/21704NF	1710-2170	4		N Female
RO8061/21702NM	806-960	1	8.6	N Male
RO8061/21702NF	1710-2170	2		N Female
W5030	2400-2500 5150-5875	4 6	6.8	N Male
RO3ISMNM	430-440 860-930	2 2.5	21.3	N Male
RO25002NF ⁽²⁾	2300-2700	2.0	5.1	N Female

(1) 3 Watt Power (2) PIM Rated to -155 dBc (3) Bracket ROKIT Available. Contact Factory.

YAGIS

Construction: Fully Welded Elements
VSWR: 2.0:1
Power Rating: 300 Watts
Wind Load: 100 mph
Feed Connection: N Female
Mounting Hardware: Included

Model	Elements	(MHz)	(dBi)	(In)
*YA3406WN	5	406-430	11	42.25
*YA3450WN	5	450-470	11	36.25
*YA5740W	7	740-806	11	32.75
*YA6740W	4	740-806	8	19.25
*YA5800W	7	806-866	11	31.25
*YA6800W	4	806-866	8	17.5
*YA5825W	7	824-896	11	31.25
*YA6825W	4	824-896	8	17.5
*YA5900W	7	890-960	11	30
*YA6900W	4	890-960	8	17.5

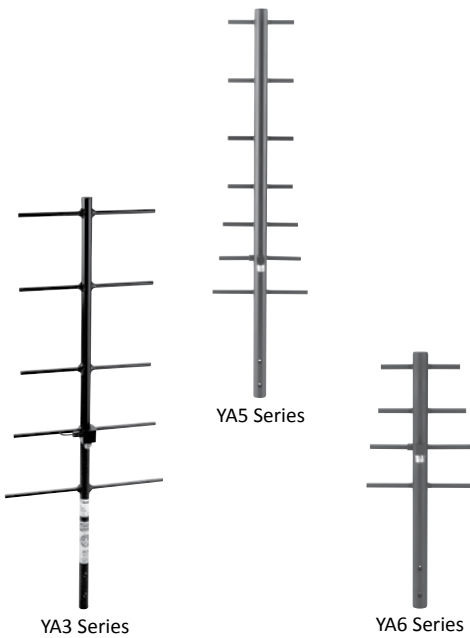

OMNI BASE STATION ANTENNAS

Omni Base Station part numbers ending in "WA" do not include mounting hardware. All others includes the appropriate FB2BRACKET or FB3BRACKET for mounting. See Page 78 for FB brackets.

Model	Type	Frequency (MHz)	Gain (dBi)	Max Height (In)	Power Rating (Watts)	Whip Color	Feed Connection
BSA45C	Base Loaded 1/4 λ	45-50	2	51.75	200	Stainless	N Female
BSA118B	5/8 λ	118-121	5.2	64	200	Black	UHF Female
BSA132B	5/8 λ	131-135	5.2	54.5	200	Black	UHF Female
BSA150B	5/8 λ	144-174	5.2	51.75	200	Black	UHF Female
BSA150C	5/8 λ	144-174	2.5	51.75	200	Black	UHF Female
BSA220C	5/8 λ	200-225	5.2	33.75	200	Stainless	UHF Female
BSA406C	5/8 over 1/2 λ	406-420	5.6	32	200	Stainless	UHF Female
BSA440C	5/8 over 1/2 λ	440-460	5.6	32	200	Stainless	UHF Female
BSA450C	5/8 over 1/2 λ	450-470	5.6	32	200	Stainless	UHF Female
BSAKIT	Base Station Ground Plane Kit				200		UHF Female
FB1136	5/8 over 1/2 λ	136-230	5.6	96	200	Stainless	UHF Female
FB2406	5/8 over 1/4 λ	406-420	5.4	32.5	200	Black	N Female
FB2450	5/8 over 1/4 λ	450-470	5.4	32.5	200	Black	N Female
FB2406W/A	5/8 over 1/4 λ	406-420	5.4	32.25	200	Black	N Female
FB2420W/A	5/8 over 1/4 λ	420-440	5.4	32.25	200	Black	N Female
FB2450W/A	5/8 over 1/4 λ	450-470	5.4	32.25	200	Black	N Female
FB3800	5/8 over 1/4 λ	806-866	5.4	16	150	Black	N Female
FB3825	5/8 over 1/4 λ	824-896	5.4	16	150	Black	N Female
FB3740WA	5/8 over 1/4 λ	740-806	5.4	16	150	Black	N Female
FB3800WA	5/8 over 1/4 λ	806-866	5.4	16	150	Black	N Female
FB3825WA	5/8 over 1/4 λ	824-896	5.4	16	150	Black	N Female
FB35T800	5/8 over 5/8 over 1/4 λ	806-866	7.2	32	150	Black	N Female
FB35T825	5/8 over 5/8 over 1/4 λ	824-896	7.2	32	150	Black	N Female
FB35T800WA	5/8 over 5/8 over 1/4 λ	806-866	7.2	32	150	Black	N Female
FB35T825WA	5/8 over 5/8 over 1/4 λ	824-896	7.2	32	150	Black	N Female
FB3 900	5/8 over 1/4 λ	890-960	5.4	16	150	Black	N Female
FB3900WA	5/8 over 1/4 λ	890-960	5.4	16	150	Black	N Female
FB35T900	5/8 over 5/8 over 1/4 λ	890-960	7.2	23	150	Black	N Female
FB35T900WA	5/8 over 5/8 over 1/4 λ	890-960	7.2	23	150	Black	N Female
FB45T2400	5/8 over 5/8 over 1/4 λ	2400-2485	7.2	16.5	100	Black	N Female
FB45T2400WA	5/8 over 5/8 over 1/4 λ	2400-2485	7.2	9	100	Black	N Female

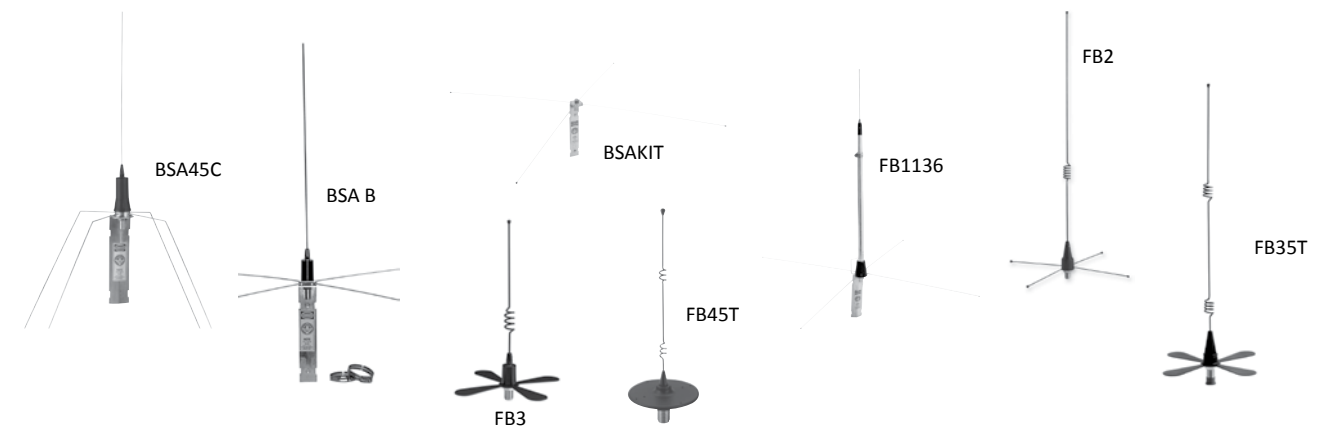

Maker Of Clarity™ Transparent Antennas!

From Your **PIMinator™** Low-Pim Solutions Expert

Distributed Antenna Systems: As consumers switch to a lifestyle of constant internet connection, the demand on wireless networks increases dramatically. The carrier networks are switching from one of coverage to capacity. Previously coverage came via cellular base stations with tower-mounted antennas with vast reach to many consumers. The future networks need to fulfill capacity demands by bringing those networks closer to the consumer, with greater data throughput reaching customers in smaller coverage areas. To meet these very high data rates it's critical to have high quality innovative components such as Pulse Electronics PIMinator™ line of in-building low-PIM antennas, Pulse clarity™ transparent antennas and accessory components.

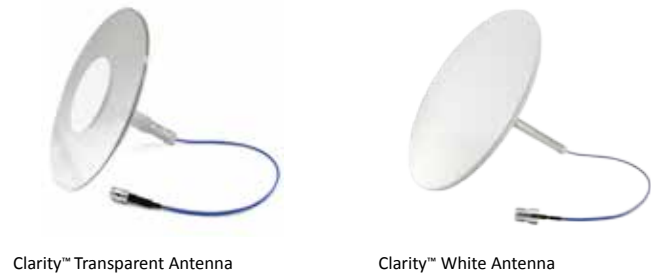

ULTRA-THIN CLARITY™ ANTENNAS				
Clarity™ Series	Pulse Part Number	Freq, MHz	PIM Rating, dBc	Connector
Ultra-Thin Clear	DASUTCC500NF	608-960/1695-2200/2300-2700MHz, Antenna only	-155	N Female w/500mm pigtail
Ultra-Thin Clear	DASUTCCR500NF	608-960/1695-2200/2300-2700MHz, with Reflector	-155	N Female w/500mm pigtail
Ultra-Thin Clear	DASUTCC500MD	608-960/1695-2200/2300-2700MHz, Antenna only	-155	4.1-9.5 Mini-DIN Female w/500mm pigtail
Ultra-Thin Clear	DASUTCCR500MD	608-960/1695-2200/2300-2700MHz, with Reflector	-155	4.1-9.5 Mini-DIN Female w/500mm pigtail
Ultra-Thin Clear	DASUTCC5004310	608-960/1695-2200/2300-2700MHz, Antenna only	-155	4.3-10 DIN Female w/500mm pigtail
Ultra-Thin Clear	DASUTCCR5004310	608-960/1695-2200/2300-2700MHz, with Reflector	-155	4.3-10 DIN Female w/500mm pigtail
Clarity	DASUTCCACC1	Reflector	N/A	N/A
Ultra-Thin White	DASUTWC500NF	608-960/1695-2200/2300-2700MHz Antenna Only	-155	N Female w/ 500mm pigtail
Ultra-Thin White	DASUTWCR500NF	608-960/1695-2200/2300-2700MHz, with Reflector	-155	N Female w/ 500mm pigtail
Ultra-Thin White	DASUTWC500MD	608-960/1695-2200/2300-2700MHz Antenna Only	-155	4.1-9.5 Mini-DIN Female w/ 500mm pigtail
Ultra-Thin White	DASUTWCR500MD	608-960/1695-2200/2300-2700MHz, with Reflector	-155	4.1-9.5 Mini-DIN Female w/ 500mm pigtail
Ultra-Thin White	DASUTWC5004310	608-960/1695-2200/2300-2700MHz Antenna Only	-155	4.3-10 DIN Female w/500mm pigtail
Ultra-Thin White	DASUTWCR5004310	608-960/1695-2200/2300-2700MHz, with Reflector	-155	4.3-10 DIN Female w/500mm pigtail



Antennas	Pulse Part Number	Freq, MHz	PIM Rating, dBc	Connector
MIMO Ceiling Mount	DASLTE500NFMIMO	698-960/1710-2170/2300-2700/4900-5900	-155	N Female w/500mm pigtail (2x)
MIMO Ceiling Mount	DAS500MDMIMO	698-960/1710-2170/2300-2700/4900-5900	-155	Mini-DIN (4.1/9.5) Female w/500mm pigtail
SISO Ceiling Mount	DASLTE500NF	698-960/1710-2170/2300-2700/4900-5900	-155	N Female w/500mm pigtail
SISO Ceiling Mount	DASLTENF	698-960/1710-2170/2300-2700/4900-5900	-155	N Female w/500mm pigtail
SISO Ceiling Mount	DASLTEMINIDIN	698-960/1710-2170/2300-2700/4900-5900	-155	Mini-DIN (4.1 / 9.5) Female w/ 500mm pigtail
SISO Ceiling Mount	DASLTEDIN	698-960/1710-2170/2300-2700/4900-5900	-155	DIN (7 / 16)

RF Splitters	Pulse Part Number	Freq, MHz	PIM Rating, dBc	Connector
Power Splitter, 2-Way, 300W	DASSPLIT2WDIN	698-2700	-155	DIN
Power Splitter, 2-Way, 300W	DASSPLIT2WNF	698-2700	-155	N Female
Power Splitter, 3-Way 300W	DASSPLIT3WNF	698-2700	-155	N Female
Power Splitter, 4-Way, 300W	DASSPLIT4WNF	698-2700	-155	N Female



PSIBVHF and PSIBVU78



Installed Condition:
PSIBVHF and PSIBVU78



PSUTWCNF

PUBLIC SAFETY DAS PRODUCTS							
Application	Frequency, MHz	Series	Part Number	PIM Rating	Connector	Color	Size (inches / mm)
UHF + 700/800	380-570; 698-960	Clarity™-Pearl	PSUTWCNF	N/A	N-Female	White	12.3" (311mm) Diameter. 0.37" (9.5mm) Below ceiling
VHF	132-174	V-Thinity™	PSIBVHF	N/A	N-Female	White	15.0x15.0 inch (380x380mm) Below Ceiling: 0.060 inch (1.5mm)
VHF+UHF+700/800	132-174; 380-570; 700-960	V-Thinity™	PSIBVU78	N/A	N-Female	White	15.4 x 13.6 inch (391 x 346mm) Below Ceiling: 0.06 inch (1.5mm)"



PSDASxx Series Top View



PSDASxx Series Bottom View

PUBLIC SAFETY + CARRIER COMBO DAS PRODUCT							
Application	Frequency, MHz	Series	Part Number	PIM Rating	Connector	Color	Size (inches / mm)
UHF (Tetra) + 3G/4G LTE (or WiFi)	380-520; 698-960; 1710-2700; 4900-6000	5Bar	PSDAS4310F	N/A	4.3-10	White	11.3 Dia x 5.4 Tall (288mm Dia. X 136mm Tall)
UHF (Tetra) + 3G/4G LTE (or WiFi)	380-520; 698-960; 1710-2700; 4900-6000	5Bar	PSDAS4310FP	-150dBc (@2x20 watts)	4.3-10	White	11.3 Dia x 5.4 Tall (288mm Dia. X 136mm Tall)
UHF (Tetra) + 3G/4G LTE (or WiFi)	380-520; 698-960; 1710-2700; 4900-6000	5Bar	PSDASNF	N/A	N-Female	White	11.3 Dia x 5.4 Tall (288mm Dia. X 136mm Tall)
UHF (Tetra) + 3G/4G LTE (or WiFi)	380-520; 698-960; 1710-2700; 4900-6000	5Bar	PSDASNFP	-150dBc (@2x20 watts)	N-Female	White	11.3 Dia x 5.4 Tall (288mm Dia. X 136mm Tall)

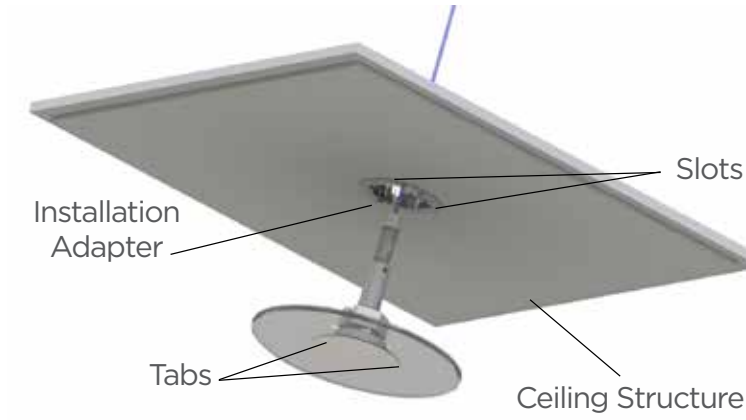

Typical Assembly using the Clarity Installation Adapter



Above-Ceiling Antenna Holder



Above-Ceiling Antenna Holder (Shown with Antenna Installed)

Items	Part Number	Function	Material Size	Comments
Above-Ceiling Antenna Holder	DASACHOLDER	Support antennas above ceiling tile rails.	Polycarbonate; 618x192x122 mm (24.4x7.6x4.4 inch)	The holder includes snap-in-place brackets for easy installation onto most standard ceiling tiles rails. Antennas are robustly held in place so the antennas cannot be disturbed when building tenant moves ceiling tiles and impacts the antenna. The plastic construction ensures PIM is not aggravated unlike competitive ferrous metal holders.
Clarity Installation Adapter	DASCLINSERT	Blind-hole installation of Clarity Antennas.	94 mm dia (3.7 inch dia)	The Installation adapter allows one-sided (blind-hole) installation of Clarity antennas when the building construction does not provide access to the backside of the antenna for installation of the provided nut. Ideal for hardpan, drywall, plank and other architectural ceiling types.
PIM-Blocker Absorber	DASACABSORBER	System PIM Reduction	(19.7 x 19.7 x 2.0 inch)	The PulseLarsen PIM Blocker absorber bag can reduce PIM by as much as 40dB when placed between antennas and the surrounding structure. The PulseLarsen PIM Blocker can also be used to improve isolation in BDA Repeater applications. See Datasheet for more details.



DAS PIM-Blocker Absorber



Clarity Installation Adapter



ICEFIN Transparent



ICEFIN White

LOW COST MONOPOLE WITH GROUND PLANE SOLUTION

Application	Frequency, MHz	SLPT White Series Antenna		IceFin™ Series Antenna		Peak Gain*	PIM Rating	Connector	Mechanical Properties
		Color	Part Number	Color	Part Number				
700 / 800	698-869	White	SLPT698/869DMNW	Transparent	ICEFIN698/869DMN	3.3 dBi	None	N-Female	1.5" dia x 3.1" tall (38mm dia. X 79 mm tall)
2G / 3G / 4G LTE	698-960 / 1710-2700	White	SLPT698/2170DMNW	Transparent	ICEFINLDMN	3.5 dBi (lower band) 4.95 dBi (upper band)	None	N-Female	1.5" dia x 3.1" tall (38mm dia. X 79 mm tall)

* Gain when using ground plane



Installed Configuration



Installed Configuration



Frame and Screws



Ground Plane

Application	Part Number	Mechanical Properties
Ground Plane (for use with above antennas)	ICEFIN-GP	15.75" Dia. X 0.040" thk (400mm Dia. X 1mm thk) Material: Aluminum"
Frame (for use with above antennas)	ICEFIN-F	2.95" Dia. (74.9mm Dia).



IN-BUILDING ANTENNA	FREQUENCY (MHZ)	HEIGHT (IN/MM)	GAIN (DBI)	CONNECTOR
Single Band Baton Style				
RO17102NM	1710-2170	4.5 / 115	2	N Female w/ 500mm pigtail
Multi Band Baton Style				
W5067	698 - 960 / 1710 - 2170 / 2400 - 2700	9.1 / 230	1 / 2	N Female
RO8061/21702NF	806-960/1710-2170	8.5 / 216	1 / 2	N Female
RO8061/21702NM	806-960/1710-2170	8.5 / 216	1 / 2	N Male
RO8063/21704NF	806-960/1710-2170	15.3 / 389	3 / 4	N Female
RO8063/21704NM	806-960/1710-2170	15.3 / 389	3 / 4	N Male
W5030	2.4-2.5/5.15-5.875 GHz	6.8 / 173	4 / 6	N Male
Public Safety Antennas				
Donor Yagi	YA34xxWN	406 thru 512Mhz	11 dBi	N Female
Donor Yagi	YA5xxW	740 thru 960	11 dBi	N Female
Donor Yagi	YA6xxW	740 thru 960	8 dBi	N Female
Base Station	FB24xx WA	406 thru 470	5.4 dBi	N Female
Base Station	FB3xxx	740 thru 960	5.4 dBi	N Female
Base Station	FB35T900x	902 thru 928	7.2 dBi	N Female

**See specific datasheet for Part Number and coverage frequency.



*MADE IN THE USA



LOW LOSS COAXIAL CABLE

Diameter of coaxial cable : 1.13mm

Part Number	Insertion Loss (dB)		Cable Length		Connector Type	
	@ 2.4GHz	@6GHz	inches	mm	1st termination	2nd Termination
W9003	-0.6	-1.4	3	76	SMA (F) Bulkhead	U.FL compatible
W9003M	-0.6	-1.4	3	76	SMA (F) Bulkhead	U.FL compatible
W9006	-0.8	-1.7	6	150	RP- SMA (F) Bulkhead	U.FL compatible
W9006M	-0.8	-1.7	6	150	SMA (F) Bulkhead	U.FL compatible
W9009C	-1	-1.9	9	229	RP- SMA (F) Bulkhead	U.FL compatible
W9009M	-1	-1.9	9	229	SMA (F) Bulkhead	U.FL compatible
W9011	-1.3	-2.6	11	280	RP- SMA (F) Bulkhead	U.FL compatible
W9011M	-1.3	-2.6	11	280	SMA (F) Bulkhead	U.FL compatible
W9015	-1.4	-2.8	15	381	RP- SMA (F) Bulkhead	U.FL compatible
W9015M	-1.4	-2.8	15	381	SMA (F) Bulkhead	U.FL compatible
W9020	-1.6	-3.2	20	508	RP- SMA (F) Bulkhead	U.FL compatible
W9020M	-1.6	-3.2	20	508	SMA (F) Bulkhead	U.FL compatible



*MADE IN THE USA

All Larsen NMOHF (high frequency 27 MHz to 6 GHz) mounts convert from low frequency applications to high frequency applications and back by pulling or replacing the center pin and insulator.

NMOHF mounts require a 3/4" hole for mounting and include 17' of coax. NMOHF mounts accommodate roof surfaces from 0.1" to .03". NMOHFTHK (thick) mounts accommodates roof surfaces up to 1/2" thick.

NMO 3/4" HIGH FREQUENCY MOUNTS

Model	Coax	Connector
*NMOKHFCX	CX (RG-58A/U)	No Conn
*NMOKHFCXFME	CX (RG-58A/U)	FME CRIMP
*NMOKHFCXMPL	CX (RG-58A/U)	MPL
*NMOKHFCXPL	CX (RG-58A/U)	PL-259
*NMOKHFDS	DS (RG-58A/U Dual Shield)	No Conn
NMOKHFUD	UD (RG-58U Dual Shield)	No Conn
*NMOKHFUDFME	UD (RG-58U Dual Shield)	FME
*NMOKHFUDMPL	UD (RG-58U Dual Shield)	MPL
*NMOKHFUDSMA	UD (RG-58U Dual Shield)	SMA
*NMOKHFUDTNC	UD (RG-58U Dual Shield)	TNC
*NMOKHFUDQMA	UD (RG58U Dual Shield)	QMA
*NMOKHF200SMAI	LMR200	SMA Installed

NMO 3/4" HIGH FREQUENCY MID-SIZE MOUNTS

Model	Coax	Connector
*NMOKHFMIDCX	CX (RG-58A/U)	No Conn
*NMOKHFMIDDS	DS (RG-58A/U Dual Shield, Low Loss)	No Conn
*NMOKHFMIDUD	UD (RG-58U, Dual Shield)	No Conn

NMO 3/4" HIGH FREQUENCY THICK MOUNTS

Model	Coax	Connector
*NMOKHFCXTHK	CX (RG-58A/U)	No Conn
*NMOKHFDSTHK	DS (RG-58A/U Dual Shield)	No Conn

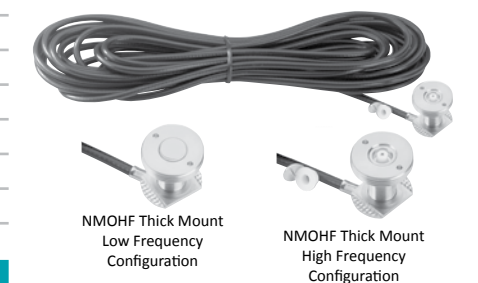
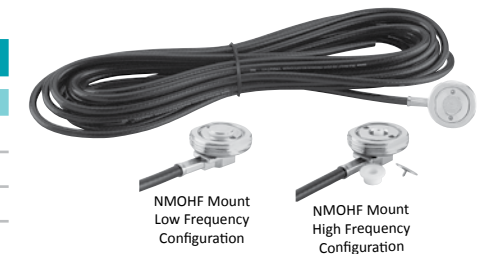



*MADE IN THE USA

If your antenna has a "tab" or "pin" connector, use the NMOHF mount in the low frequency configuration - leave the center pin and insulator in place as it arrives from the factory.



If your antenna has a "high frequency" (HF) connector, use the NMOHF mount in the high frequency configuration - remove the center pin and insulator.



NMO 3/4" STANDARD MOUNTS

NMO 3/4" standard mounts require a 3/4" hole for mounting and include 17' of coax.

Model	Coax	Connector
NMOKNOCONN	CX (RG-58A/U)	No Conn
*NMOK	CX (RG-58A/U)	PL-259
*NMOKFME	CX (RG-58A/U)	FME
*NMOKMPL	CX (RG-58A/U)	MPL Crimp
*NMOKDS	DS (RG-58A/U Dual Shield)	No Conn
*NMOKDSFME	DS (RG-58A/U Dual Shield)	FME
NMOKUD	UD (RG-58U Dual Shield)	No Conn
*NMOKUDFME	UD (RG-58U Dual Shield)	FME
*NMOKUDPL	UD (RG-58U Dual Shield)	PL-259T
*NMOKUDTNC	UD (RG-58U Dual Shield)	TNC

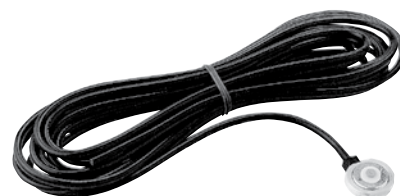

NMO HIGH FREQUENCY MOUNTS

Model	Inches	Thickness	Cable
NMOHF	.03-.1"	0.761-2.54 mm Standard	Not included
NMOHF MID	.03-.23"	0.761 - 5.90 mm Mid-Thickness	Not included (1)
NMOHF THK	.03-.5"	1.6 - 12.7 mm Greatest Thickness	Not included

(1) Special tool required to install to coax.



*MADE IN THE USA

All Larsen NMOHF (high frequency 27 MHz to 6 GHz) mounts convert from low frequency applications to high frequency applications and back by pulling or replacing the center pin and insulator.

NMO HIGH FREQUENCY MAGNETIC MOUNTS

NMOHF round magnetic mounts have the following specifications:

Size: 3.5" Diameter
 Cable Length: 12'
 Pull Strength: 80 lbs



Model	Coax	Length	Connector
*NMOMMRNOCONN	CX (RG-58A/U)	12'	No Connector
*NMOMMR	CX (RG-58A/U)	12'	58FCP
*NMOMMRFME	CX (RG-58A/U)	12'	FME Crimp
*NMOMMRPL	CX (RG-58A/U)	12'	PL-259
*NMOMMRMPL	CX (RG-58A/U)	12'	MPL Crimp
*NMOMMRTNC	CX (RG-58A/U)	12'	TNC
*NMOMMRNBNC	CX (RG-58A/U)	12'	BNC
*NMOMMRN	CX (RG-58A/U)	12'	N Crimp
*NMOMMRDS	DS (RG-58A/U Dual Shield)	12'	No Connector
*NMOMMRDSFME	DS (RG-58A/U Dual Shield)	12'	FME
*NMOMMRDSMPL	DS (RG-58A/U Dual Shield)	12'	MPL Crimp
*NMOMMRDSN	DS (RG-58A/U Dual Shield)	12'	N Male
*NMOMMRDSSMA	DS (RG-58A/U Dual Shield)	12'	SMA
*NMOMMRDSSMAR/P	DS (RG-58A/U Dual Shield)	12'	RP SMA
*NMOMMRDSPL	DS (RG-58A/U Dual Shield)	12'	PL-259T
*NMOMMRDSTNC	DS (RG-58A/U Dual Shield)	12'	TNC
*NMOMMRDS17BNC	DS (RG-58A/U Dual Shield)	17'	BNC
*NMOMMRDS17SMARP	DS (RG-58A/U Dual Shield)	17'	RP SMA
*NMOMMRDSNF	DS (RG-58A/U Dual Shield)	12'	N Female
*NMOMMRDSTNC3	DS (RG-58A/U Dual Shield)	3'	TNC
*NMOMMRDSTNC8	DS (RG-58A/U Dual Shield)	8'	TNC
*NMOMMRUD17FME	UD (RG-58U Dual Shield)	17'	FME
*NMOMMRUD25FME	UD (RG-58U Dual Shield)	25'	FME
*NMOMMRUD25NC	UD (RG-58U Dual Shield)	25'	No Connector
*NMOMMRUDNOCONN	UD (RG-58U Dual Shield)	12'	No Connector
*NMOMMR200NOCONN	LMR200	12'	No Connector
*NMOMMR200SMA	LMR200	12'	SMA
*NMOMMR200N	LMR200	12'	N Crimp
*NMOMMR200N1	LMR200	1'	N Male
*NMOMMR200NF12	LMR200	12'	N Female
*NMOMMR200NF3	LMR200	3'	N Female
*NMOMMR200RPSMA	LMR200	12'	RP SMA
*NMOMMR200SMA20	LMR200	20'	SMA
*NMOMMR200TNC30	LMR200	30'	TNC
*NMOMMR240NOCONN	LMR240	12'	No Connector
*NMOMMR240NOCONN1	LMR240	1'	No Connector
*NMOMMR240NOCONN3	LMR240	3'	No Connector

NMO 3/8" THICK MOUNTS

NMO 3/8" mounts have the following specifications:

Mounting: 3/4" hole
 Mounting Surface: 0.15" to 0.22" thickness (3.81-5.59mm)
 Cable Length: 17'



Model	Coax	Connector
*NMOKCX38THK	CX (RG-58A/U)	No Conn
*NMOKUD38THK	DS (RG-58A/U Dual Shield)	No Conn



*MADE IN THE USA



*MADE IN THE USA

All Larsen NMOHF (high frequency 27 MHz to 6 GHz) mounts convert from low frequency applications to high frequency applications and back by pulling or replacing the center pin and insulator.

GPS LTE DIRECT MOUNTS

NMOHFGPS mounts have the following specifications:

Frequency: 1575.4 - 1576.4 MHz Gain: 5 dBic
 Polarization: Right-Hand Circular / Vertical LNA Gain: 26 dB ± 2 dB
 Cable: 16.4' RG-174 (GPS) VSWR: Less than 2:1
 16.4' RG-58 (NMOHF) Size: .5 x 2 x 4.5
 Voltage: 3 or 5 V DC Color: Black
 Mounting: 5/8 " Hole

Model	Connectors
*NMOHFGPSFMENOCNN	FME/No Connector
*NMOHFGPSFMESMA	FME/SMA
*NMOHFGPSNOCNN	No Connectors
*NMOHFGPSSMASMA	SMA/SMA

NOTE: Specifications listed refer to GPS performance. Additional antenna specifications are dependent on the antenna mounted on the NMO side.



NMO SQUARE MAGNETIC MOUNTS

NMO square magnetic mounts have the following specifications:

Size: 3.5" x 3"
 Cable Length: 12'
 Pull Strength: 50 lbs

Model	Coax	Connector
*NMOMMNOCONN	CX (RG-58A/U)	No Conn
*NMOMMMPL	CX (RG-58A/U)	MPL
*NMOMM	CX (RG-58A/U)	58FCP
*NMOMMBNC	CX (RG-58A/U)	BNC
*NMOMMPL	CX (RG-58A/U)	PL-259
*NMOMMFME	CX (RG-58A/U)	FME
*NMOMMDSFME	DS (RG-58A/U Dual Shield)	FME



NMO TRUNK LID MOUNTS

NMO trunk lid mounts have the following specifications:

Size: 2.5" x 2"

Model	Coax	Cable Length	Connector
*NMOTLP	CX (RG-58A/U)	17 ft.	PL-259
*NMOTLPFME	CX (RG-58A/U)	17 ft.	FME
*NMOHFTLP200NF	LMR-200	17 ft.	N-Female
*NMOHFTLP200NF12	LMR-200	12 ft.	N-Female



LM MOUNTS

Model	Coax	Connector
*LMKNOCONN	CX (RG-58A/U)	No Conn
*LMKFME	CX (RG-58A/U)	FME
*LMK	CX (RG-58A/U)	PL-259
*LMKDS	DS (RG-58A/U Dual Shield)	No Conn
*LMKDSFME	DS (RG-58A/U Dual Shield)	FME
LMKUD	UD (RG-58U Dual Shield)	No Conn
LMKUDFME	UD (RG-58U Dual Shield)	FME

LMMM MAGNETIC MOUNTS

LM magnetic mounts have the following specifications:

Size: 3.5" x 3" Cable Length: 12'
 Type: 5/16" x 24 THDS Pull Strength: 50 lbs

Model	Coax	Connector
*LMMMFMFME	CX (RG-58A/U)	FME Crimp
*LMMMFMPL	CX (RG-58A/U)	MPL Crimp
*LMMM	CX (RG-58A/U)	58FCP
*LMMMBNC	CX (RG-58A/U)	BNC Crimp
*LMMMPL	CX (RG-58A/U)	PL-259
*LMMMDS	DS (RG-58A/U Dual Shield)	No Conn
*LMMMDSFME	DS (RG-58A/U Dual Shield)	FME

LM TRUNK LID MOUNTS

LM trunk lid mounts have the following specifications:

Size: 2.5" x 2" Cable Length: 17'
 Type: 5/16" x 24 THDS

Model	Coax	Connector
*LMTLP	CX (RG-58A/U)	PL-259
*LMTLPDS	DS (RG-58A/U Dual Shield)	Order Separately

PO MOUNTS

Model	Coax	Connector
*POKNOCONN	CX (RG-58A/U)	No Conn

PO MAGNETIC MOUNTS

PO magnetic mounts have the following specifications:

Size: 3.5" x 3" Cable Length: 12'
 Type: SO-239 Female Pull Strength: 50 lbs

Model	Coax	Connector
*POMM	CX (RG-58A/U)	58FCP

SMA CONNECTORS

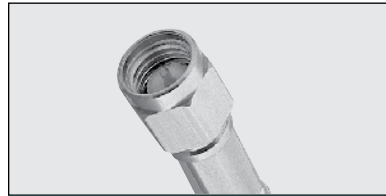

MODEL	DESCRIPTION
SMACP58	SMA Crimp Plug 58/U
CABLE GROUP	58

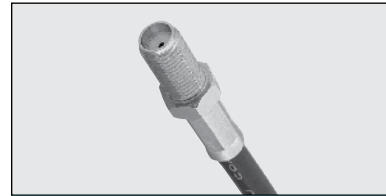

MODEL	DESCRIPTION
SMACJ	SMA Crimp Jack 58/U
CABLE GROUP	58

BNC CONNECTORS



MODEL	DESCRIPTION
BNCCRIMP	BNC Crimp Plug 58/U
CABLE GROUP	58



MODEL	DESCRIPTION
BNCCJ58	BNC Crimp Jack 58/U
CABLE GROUP	58



MODEL	DESCRIPTION
BNC174	BNC Crimp Plug 174/U
CABLE GROUP	174

N CONNECTORS



MODEL	DESCRIPTION
NCRIMP	N Crimp Plug 58/U
CABLE GROUP	58



MODEL	DESCRIPTION
N8	N Clamp Plug 8/U
CABLE GROUP	8



MODEL	DESCRIPTION
NCBJ58	N Crimp Blk Jack 58/U
CABLE GROUP	58

TNC CONNECTORS



MODEL	DESCRIPTION
TNCCRIMP	TNC Crimp Plug 58/U
CABLE GROUP	58



MODEL	DESCRIPTION
TNC	TNC Clamp Plug 58/U
CABLE GROUP	58



MODEL	DESCRIPTION
TNCCJ	TNC Crimp Jack 58/U
CABLE GROUP	58



MODEL	DESCRIPTION
TNCCBJ	TNC Crimp Blk Jack 58/U
CABLE GROUP	58



MODEL	DESCRIPTION
TNCAP	TNC Angle Plug 58/U
CABLE GROUP	58

UHF CONNECTORS



MODEL	DESCRIPTION
MPLCRIMP	M/UHF Crimp Plug 58/U
CABLE GROUP	58



MODEL	DESCRIPTION
MPLCP	M/UHF Crimp Plug 174/U
CABLE GROUP	174

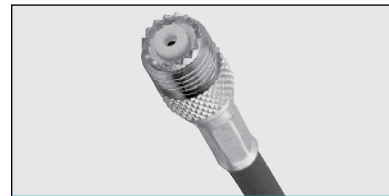

MODEL	DESCRIPTION
MPLCJ58	M/UHF Crimp Jack 58/U
CABLE GROUP	58

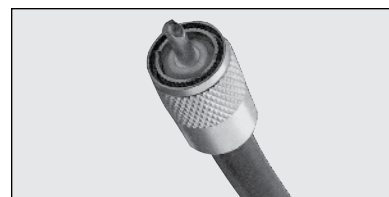

MODEL	DESCRIPTION
PL2598PHN	UHF Solder Plug PL 259/U
CABLE GROUP	8

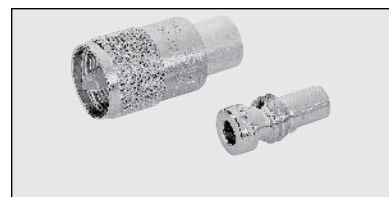

MODEL	DESCRIPTION
PL259T	UHF Solder Plug PL259/U with Teflon & Silver UG175 adapter 8/58
CABLE GROUP	8/58

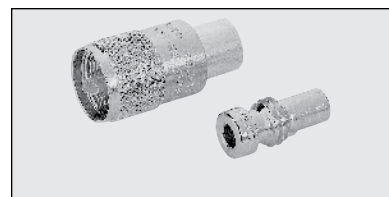

MODEL	DESCRIPTION
PL259	UHF Solder Plug PL259/U with UG 175 adapter 8/58
CABLE GROUP	8/58

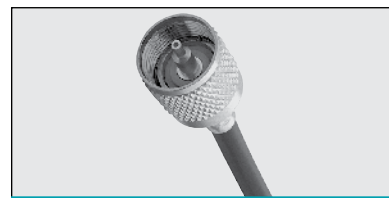

MODEL	DESCRIPTION
PLCP	UHF Crimp Plug 58/U
CABLE GROUP	58



MODEL	DESCRIPTION
58FCP	UHF FCP Plug 58/U
CABLE GROUP	58

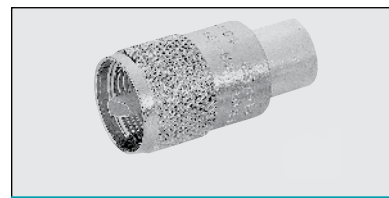

MODEL	DESCRIPTION
PL2598	UHF Solder Plug PL259/U, Teflon & Silver Plate 8/58
CABLEGROUP	8/58

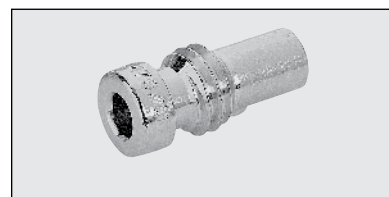

MODEL	DESCRIPTION
UG175	UHF Reducing adapter 58/U
CABLE GROUP	58



MODEL	DESCRIPTION
PL258	UHF adapter J/J



MODEL	DESCRIPTION
UHFBJJ	UHF bulkhead

FME CONNECTORS



MODEL	DESCRIPTION
FMECP58	FME Crimp Plug 58/U
CABLE GROUP	58



MODEL	DESCRIPTION
FMECRIMP	FME Crimp Jack 58/U
CABLE GROUP	58



MODEL	DESCRIPTION
FMECJ174	FME Crimp Jack 174/U
CABLE GROUP	174



MODEL	DESCRIPTION
FB	FME adapter to BNC plug



MODEL	DESCRIPTION
FT	FME adapter to TNC plug



MODEL	DESCRIPTION
FM	FME adapter to mini-UHF plug



MODEL	DESCRIPTION
FN	FME adapter to N plug



MODEL	DESCRIPTION
FP	FME adapter to UHF plug

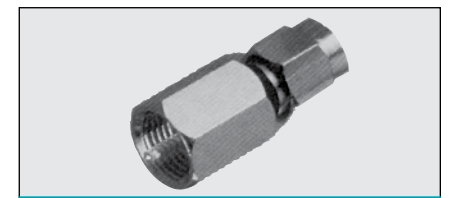

MODEL	DESCRIPTION
FSM	FME adapter to SMA plug



MODEL	DESCRIPTION
FSF	FME adapter to SMA jack



MODEL	DESCRIPTION
6 x 32	Set Screws
8 x 32	Set Screws



MODEL	DESCRIPTION
A4	BSA/BA/SO-239 to NMO mount adapter



MODEL	DESCRIPTION
BA	Bulkhead mount adapter with hardware



MODEL	DESCRIPTION
HS1	3/4" hole saw fits 3/8" or larger drills



MODEL	DESCRIPTION
HSBLADE	Replacement blades for HS1



MODEL	DESCRIPTION
KGREINSTALL	KG glassmount installation kit die cut tape



MODEL	DESCRIPTION
BAHEXNUT	Hex nut for BA



MODEL	DESCRIPTION
BALL1B	Black teardrop rod tip for W490, W540 tapered rods
BALL2B	Black teardrop rod tip for Q and NMOQ antennas
BALL3B	Black teardrop rod tip for .100 diameter non-tapered rods
BALL4	Rod tip WBQ800 antennas



MODEL	DESCRIPTION
BANOHardware	Bulkhead mount adapter without hardware

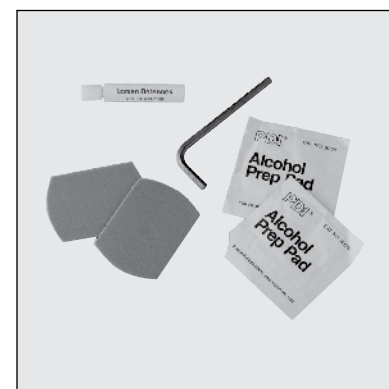

MODEL	DESCRIPTION
KGREINSTALLDC	KG glass mount installation kit die cut tape



MODEL	DESCRIPTION
KGSWIVEL.073	KG swivel mount assembly, .073 dia
KGSWIVEL.100	KG swivel mount assembly, .100 dia

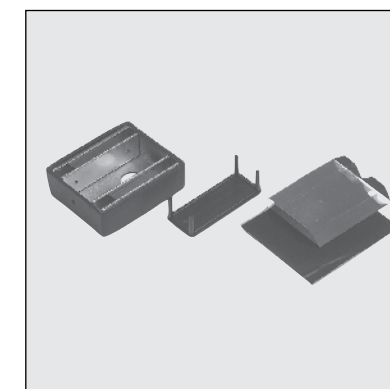

MODEL	DESCRIPTION
MM34	Rectangular mag mount housing, 3/4" hole

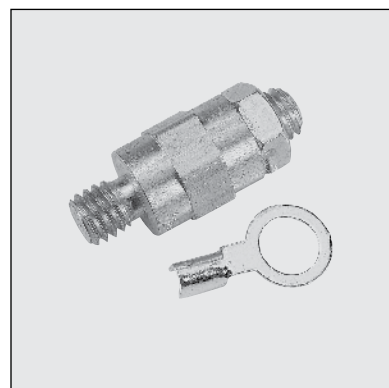

MODEL	DESCRIPTION
BATTBOLT	Battery bolt with terminals, 3/8" ring leads



MODEL	DESCRIPTION
GROMMETS	Qty 100 plastic grommet secures/centers coax, 3/4" hole



MODEL	DESCRIPTION
HP34	Plastic hole plug for 3/4" hole
HP38	Plastic hole plug for 3/8" hole



MODEL	DESCRIPTION
NMOBRASSRING	Nickel plated brass ring for NMO and NMOHF mounts



MODEL	DESCRIPTION
NMOCAPB	Rain cap for NMO mount

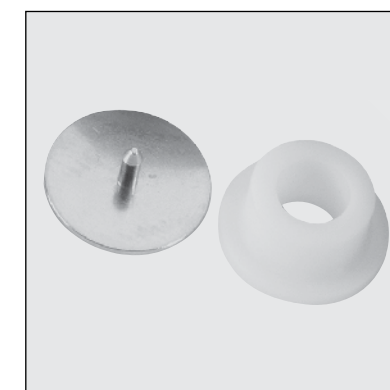

MODEL	DESCRIPTION
HFCENTERCONTACT	NMOHF Center Contacts and Insulators - 10 each



MODEL DESCRIPTION
 NMOTEST1 Test adapter for NMO mount

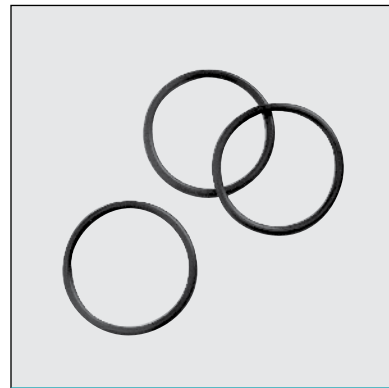

MODEL DESCRIPTION
 OLMMNT O ring for LM mount
 ONMOANT O ring for NMO antennas/bases
 ONMOMNT O ring for NMO mount
 OPOMNT O ring for PO mount



MODEL DESCRIPTION
 QCONE.073 Chrome Q cone / Q base, .073 dia.
 QCONE.100 Chrome Q cone / Q base, .100 dia.
 QCONE.125 Chrome Q cone / Q base, .125 dia.



MODEL DESCRIPTION
 SPRING Chrome shock spring
 Shock Spring
 QCONE Q Base
 .100 dia & wrench included



MODEL DESCRIPTION
 SPRINGB Black shock spring
 Shock Spring
 QCONE.100B Q Cone
 .100 dia & wrench included

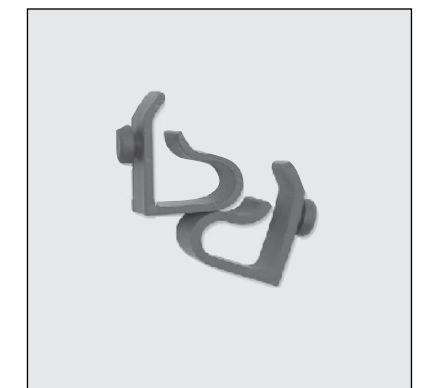

MODEL DESCRIPTION
 WACLIP Mounting clips for WA700/2700 Series - 2 per package



MODEL DESCRIPTION
 QCONE.073B Black Q cone / Q base, .073 dia.
 QCONE.100B Black Q cone / Q base, .100 dia.
 QCONE.125B Black Q cone / Q base, .125 dia

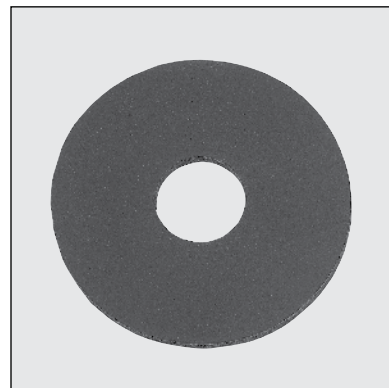

MODEL DESCRIPTION
 RGFB1ANT Rubber gaskets for FB1 antenna

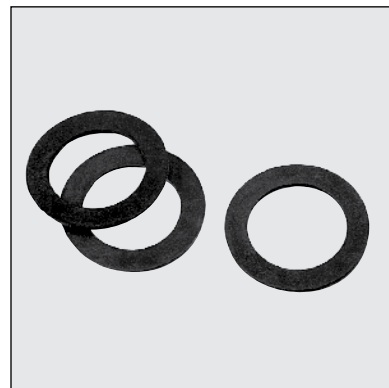

MODEL DESCRIPTION
 RGNMOANT Rubber gasket for NMO coil/bases
 RGPOMNT Rubber gasket for PO mounts



MODEL DESCRIPTION
 WASUCTIONCUP Suction cup mounts for WA700/2700 Series - 2 per package

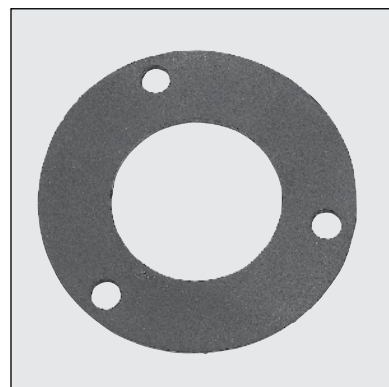

MODEL DESCRIPTION
 RGOMANT Rubber gasket for OM bases

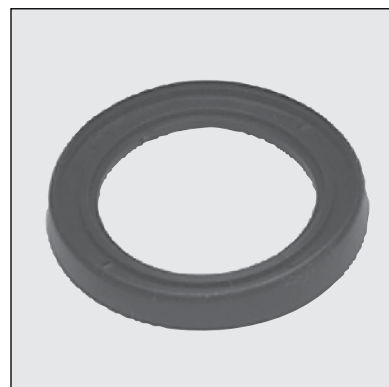

MODEL DESCRIPTION
 RGSS Rubber SuperSeal gasket for MakroBlend® coils / bases

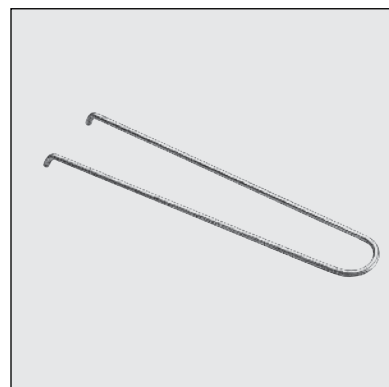

MODEL DESCRIPTION
 SPANNER Spanner wrench for PO and NMOK mounts



MODEL DESCRIPTION
 TMB34B Black trunk gutter bracket. Screws included.
 TMB38B
 TMB58B

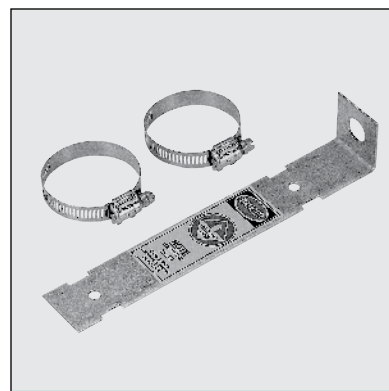

MODEL DESCRIPTION
 FB2BRACKET Mounting bracket and hardware for FB2 series

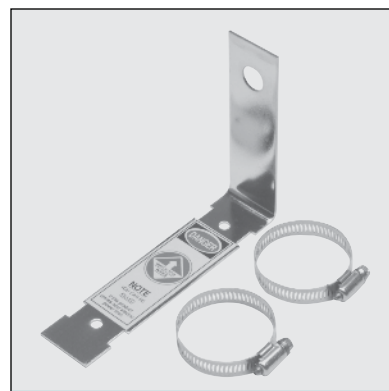

MODEL DESCRIPTION
 FB3BRACKET Mounting bracket and hardware for blade and round FB antennas

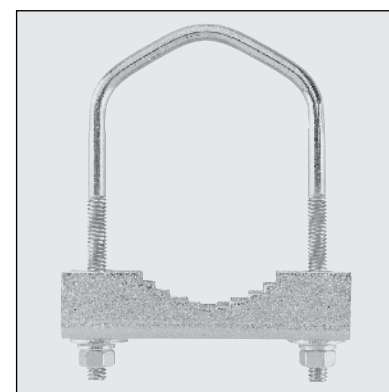

MODEL DESCRIPTION
 YAGIKITHD Mounting hardware for 2 1/2" pipe for YA3, YA5 and YA6 antennas



MODEL DESCRIPTION
 BRK0003 Universal multipurpose antenna mounting bracket, mounts to pipe, wall & I-Beam



MODEL DESCRIPTION
 TMBOM Chrom trunk gutter bracket for OM antennas. Screws included.

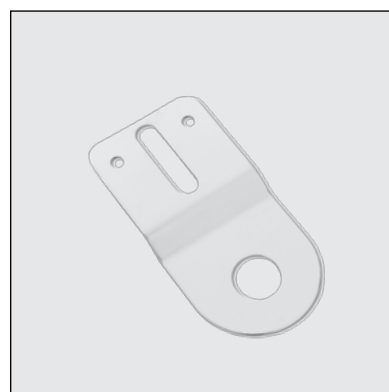

MODEL DESCRIPTION
 TMB34D Fender bracket only Fits Dodge Ram Trucks. Year 2002 and Older



MODEL DESCRIPTION
 TMB34
 TMB38
 TMB58 Chrome trunk gutter bracket. Screws included



MODEL DESCRIPTION
 ROKIT Radome Omni Pipe Mounting Bracket



MODEL DESCRIPTION
 GPSMBMM Panther series Magnetic Mount Bracket



MODEL DESCRIPTION
 LPMB4BRACKETMM Jaguar series Magnetic Mount Bracket, over ground plane solution

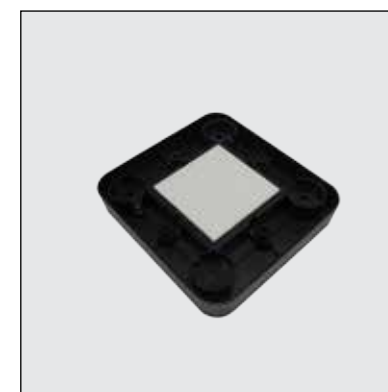

MODEL DESCRIPTION
 LPMB4BRACKETAM Jaguar series Adhesive Mount Bracket

COAX TYPES/PART NUMBERS



RG-174 - Small Diameter Coax

RG-174 is the industry standard for applications requiring a small diameter, highly flexible coax. Frequently used in mobile mag mount applications. Subject to higher losses at higher frequencies. Good performance for environmental variations but lower in overall ruggedness.

Recommended Applications

Mobile/Portable less than 900 MHz where flexibility and small diameter is important.

Larsen Part Number: RG-174
 Stocking Lengths: 1000'/Spool
 Cut to order



RG-213 - Stranded Bare Braid - Mil Spec QPI

This RG-8-sized cable uses a stranded center conductor with a polyethylene dielectric and PVC jacket. Built to Mil Specs this cable is used in all Larsen UHF/VHF products targeted for outdoor installation.

Recommended Applications

For lower frequency applications requiring high ruggedness.

Larsen Part Number: RG-213
 Stocking Lengths: 500' or 1000'/Spool
 Cut to order



RG-58U - Low Loss Dual Shield with Solid Center Conductor (UD)

This is Larsen's premium coax for 800 and 900 MHz applications. The solid center conductor (20 AWG) is easy to use with all connectors. Digital applications benefit from the 100% Duofoil aluminum shield. The shield is not glued to the dielectric making it easier to peel back for connector installation. The braid is 95% coverage. This cable is standard for most mounting kits over 800 MHz and can be special ordered with other frequencies. Uses standard RG-58 connectors.

Recommended Applications

For all applications at 800 MHz and above

Larsen Part Number: UD Coax
 Stocking Lengths: 1000'/Spool
 Cut to order



RG-58A/U - CX Standard Coax

The industry standard in quality, value-priced coax. Stranded center conductor offers good flexibility and long-life under most conditions. Not typically recommended for applications above 512 MHz due to higher losses. Uses standard RG-58 connectors.

Recommended Applications

General applications under 512 MHz. First choice for value priced coax.

Larsen Part Number: CX Coax
 Stocking Lengths: 1000'/Spool
 Cut to order



RG-58A/U - "Digi-Shield"™ Low Loss Braided Center

Employs two shields, consisting of a full aluminum/mylar wrap covered by a braid. This combination of shields, plus low-loss dielectric material and stranded center conductor makes an excellent choice for mobile applications. Performance features include low-loss and high flexibility. Uses standard RG-58 connectors.

Recommended Applications

Higher performance applications where lower loss and flexibility are important. Recommended for applications above 800 MHz.

Larsen Part Number: DS Coax
 Stocking Lengths: 1000'/Spool
 Cut to order

COAX SPECIFICATION COMPARISON

TECHNICAL CHARACTERISTICS OF INSULATION AND JACKET COMPOUNDS

PVC	POLYETHYLENE (SOLID AND FOAM)	TEFLON
Sometimes referred to as vinyl or polyvinyl chloride. Extremely high or low temperature properties cannot be found in one formulation. Certain formulations may have -55° C to +105° C rating. Other common vinyls may have -20° C to +60° C. There are many formulations for the variety of different applications. The many varieties of PVC also differ in pliability and electrical properties. The price range can vary accordingly. Typical dielectric constant values can vary from 3.5 to 6.5.	A very good insulation in terms of electrical properties. Low dielectric constant, a stable dielectric constant over all frequencies, very high insulation resistance. In terms of flexibility, polyethylene can be rated stiff to very hard, depending on molecular weight and density — low-density being the most flexible, and high-density, high-molecular weight formulation being very hard. Moisture resistance is rated excellent. Correct Brown and Black formulations have excellent weather resistance. The dielectric constant is 2.3 for solid insulation and 1.64 for foam designs. Flame retardant formulations are available with dielectric constants ranging from about 1.7 for foam flame retardant to 2.58 solid flame retardant polyethylene.	This material has excellent electrical properties, temperature range and chemical resistance. It is not suitable where subjected to nuclear radiation and does not have good high voltage characteristics. FEP Teflon is extrudable in a manner similar to PVC and polyethylene. This means long wire and cable lengths are available. TFE Teflon is extrudable in hydraulic ram-type process. Lengths are limited due to amount of material in the ram, thickness of the insulation and preform size. TFE must be extruded over a silver- or nickel-coated wire. The nickel- and silver-coated designs are rated 260° C and 200° C maximum, respectively. The cost of Teflon is approximately 8 to 10 times more per pound than PVC compounds.

Comparative Properties of Insulation and Jacket

PVC Low-density Polyethylene		
Oxidation Resistance	E	E
Heat Resistance	G-E	G
Oil Resistance	F	G-E
Low Temperature Flexibility	P-G	E
Weather, Sun Resistance	G-E	E
Ozone Resistance	E	E
Abrasion Resistance	F-G	G
Electrical Properties	F-G	E
Flame Resistance	E	P
Nuclear Radiation Resistance	F	G-E
Water Resistance	F-G	E
Acid Resistance	G-E	G-E
Alkali Resistance	G-E	G-E
Gasoline, Kerosene, Etc. (Aliphatic Hydrocarbons) Resistance	P	G-E
Benzol, Toluol, Etc., (Aromatic Hydrocarbons) Resistance	P-F	P
Degreaser Solvents (Halogenated Hydrocarbons) Resistance	P-F	G
Alcohol Resistance	G-E	E
Underground Burial	P-G	G

P = Poor F = Fair G = Good E = Excellent

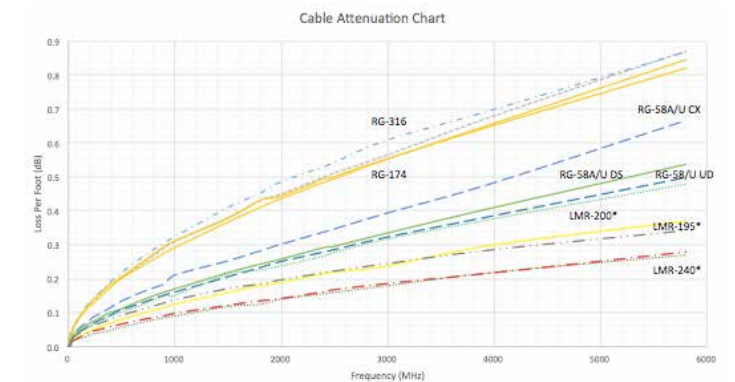

Nominal Temperature Range/Insulating and Jacketing Compounds

Compound	Normal Low	Normal High	Special Low	Special High
Polyethylene - Solid	-60° C	80° C	--	--
Polyethylene - Foam	-60° C	80° C	--	--
FEP Teflon	-70° C	200° C	--	--
PVC	-20° C	80° C	-55° C	105° C
TFE Teflon	-70° C	260° C	--	--

Note: Ordes for 1000 foot full spools may ship with up to one splice per spool.



CONTACT US TODAY!

☎ Call us at **+1.800.ANTENNA**

🌐 Visit our website at: **pulselarsenantennas.com**

🐦 Connect with us on twitter: **PulseLarsen1**



Worldwide Headquarters
San Diego, CA, USA
15255 Innovation Drive #100
San Diego, CA 92128
+1-858-674-8100

Vancouver, WA, USA
18110 SE 34th Street
Suite 250, Building 2
Vancouver, WA 98683
Tel: **+1-360-944-7551**
antennas.us@pulseelectronics.com

Europe - Finland
Automaatitietie 1, FI-90440 Oulunsalo.
Tel: **+358-20-7935-500**
antennas.eu@pulseelectronics.com

Europe - Germany
Campus Berliner Allee
Berliner Allee 65 D-64295
Darmstadt Germany
Tel: **+49.173.659.85.21**
antennas.eu@pulseelectronics.com

ISO Manufacturing Site
No 99. Huo Ju road, Suzhou new District,
Jiangsu Province, Suzhou, China, PRC.
Tel: **+86-512-69206053**
antennas.as@pulseelectronics.com

