

General information

Antenna covering NB-IoT Band 8 and 20 (791 - 960 MHz), GSM 900 (880-960 MHz), GSM 1800 (1710-1880 MHz), GSM 1900 (1850-1990 MHz) and UMTS-2100 (2110-2170 MHz) for inside mounting on non-conductive surfaces, such as plastic.

InSide GSM/NB-IoT Flex is a ground plane independent antenna including coaxial cable with connector and are supplied with adhesive.

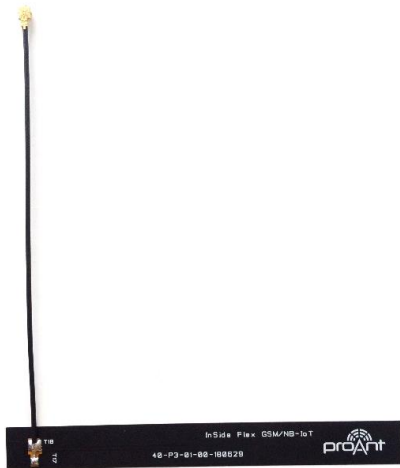

Technical data

Frequency	791-960/1710-2170 MHz
Return loss	< -6 dB (on Proant fixture)
Gain	Max 5.5 dBi (on Proant fixture)
Dimension	10 x 93 mm, thickness 0.13 mm
Mounting	Adhesive tape
Temperature	-40 to +85° C

Applications

- IoT devices
- M2M-communications
- Telemetric
- Automated meter reading
- Alarms

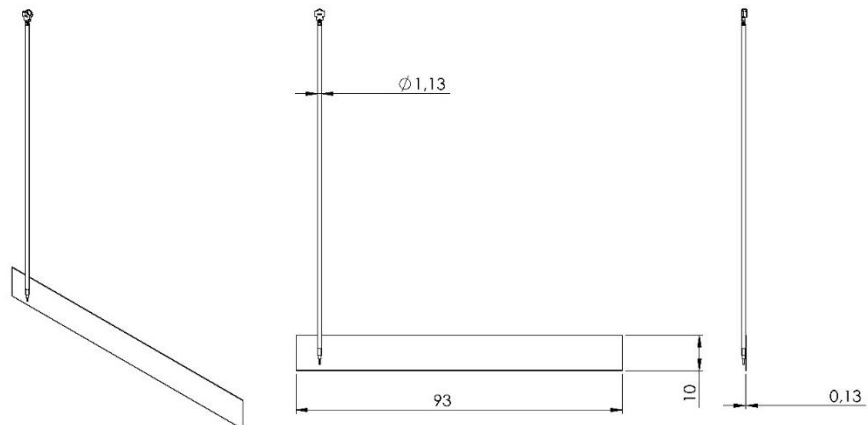

Electrical performance

Measurement setup

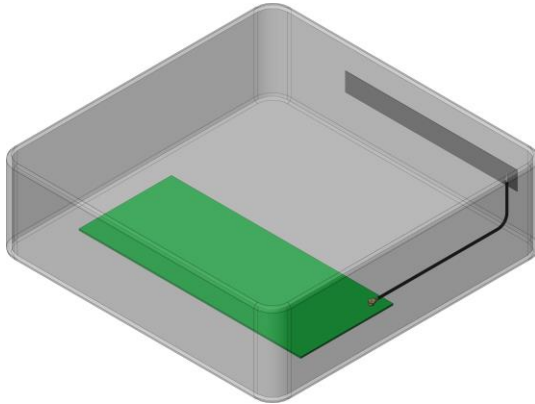

The antenna measurements were done on Proant's standard measurement fixture - the antenna mounted in an ABS plastic box, 150x150x45 mm, connected to a PCB, 120x50 mm, with the cable fully extended.

Return loss

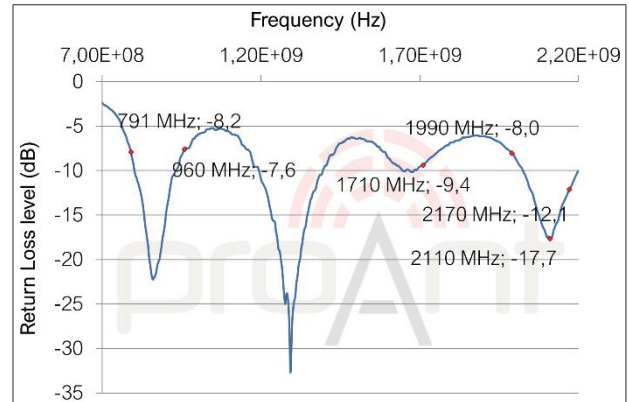

Total radiation efficiency

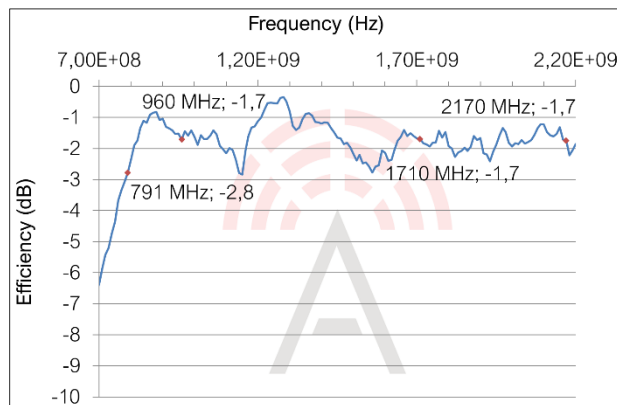

Maximum radiation gain

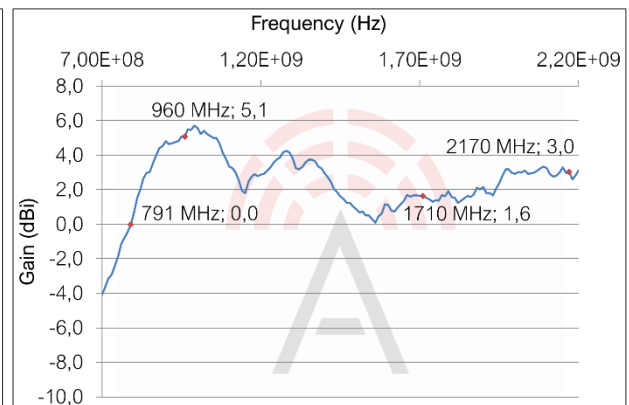

Radiation pattern, 800/850/900 MHz

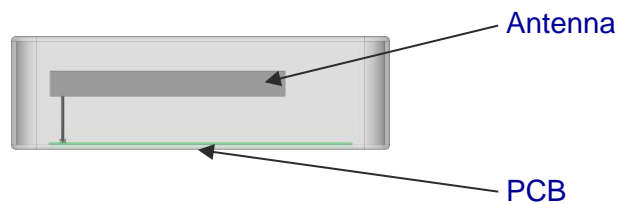
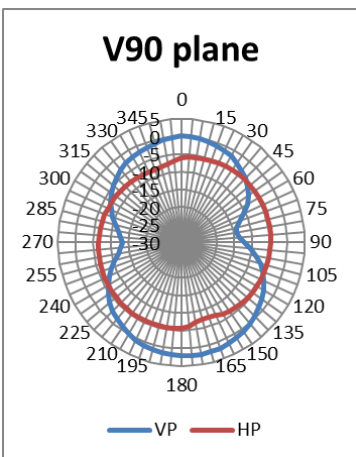
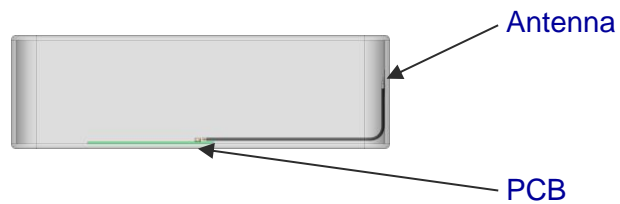
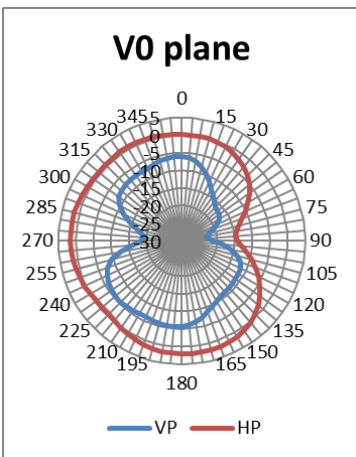
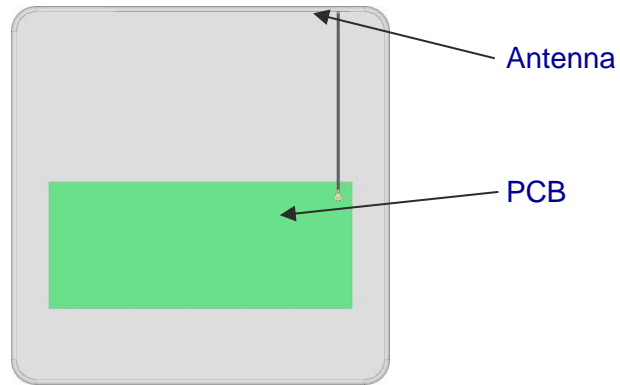
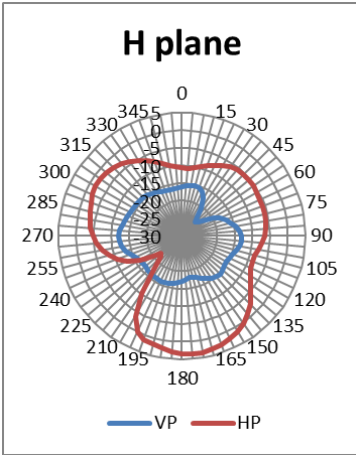

Radiation pattern, 1800/1900 MHz

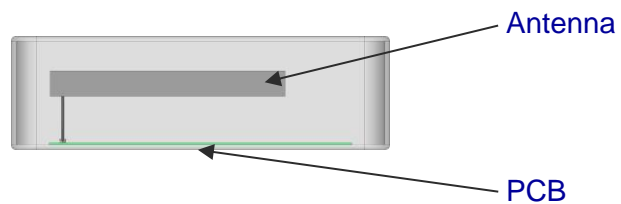
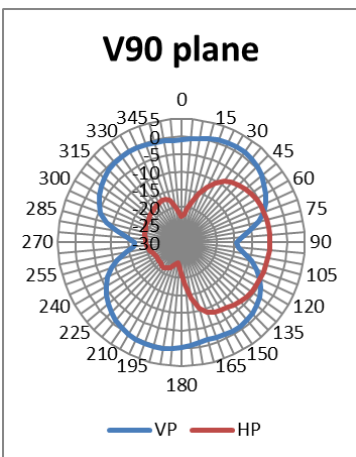
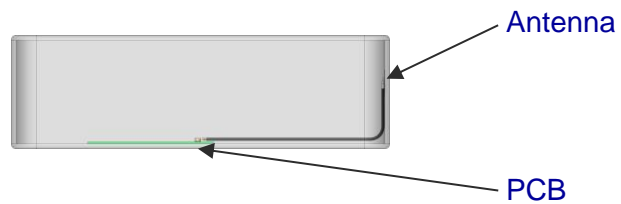
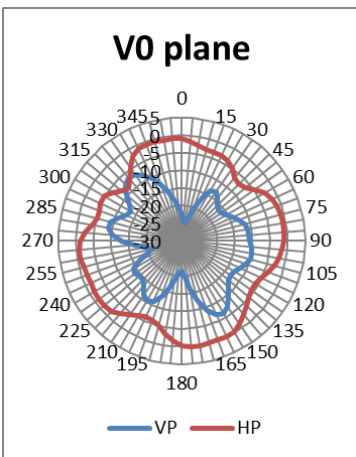
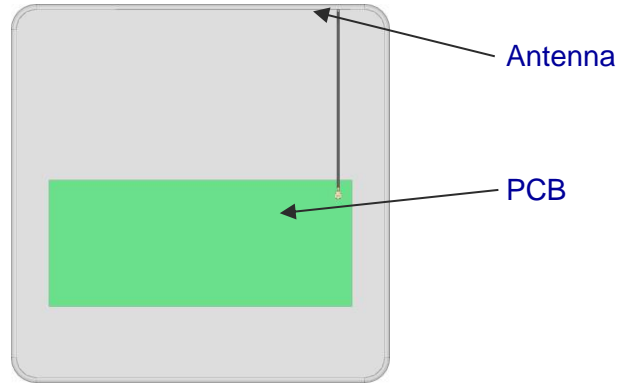
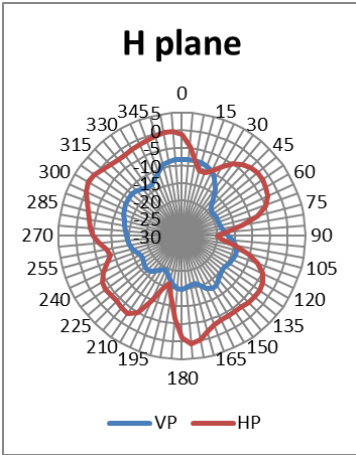

Radiation pattern, 2100 MHz

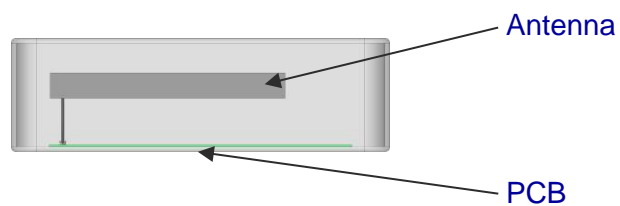
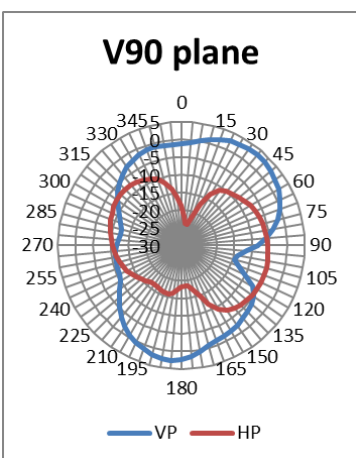
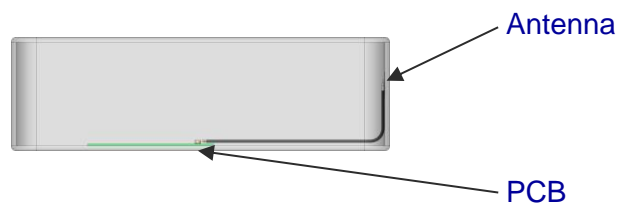
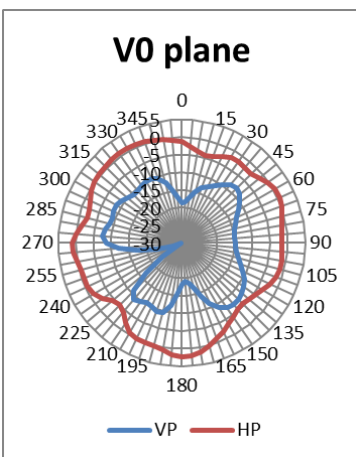
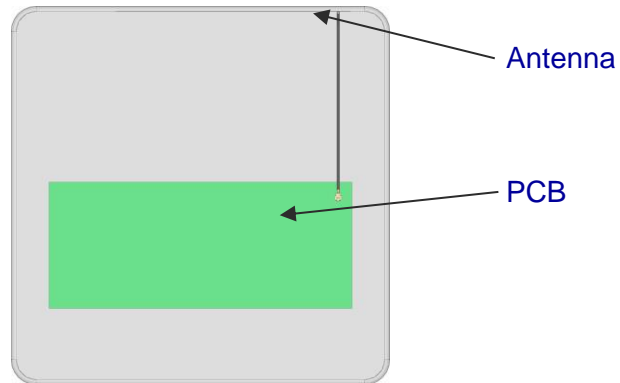
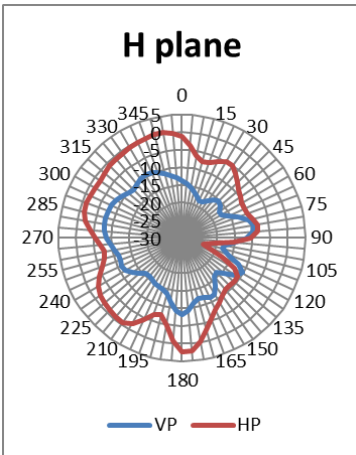

Intended applications

The antenna is optimized for pentaband operation in the GSM, UMTS and NB-IoT systems, which is defined by several frequency bands. Some of the supported bands are:

GSM/GPRS/EDGE	GSM 850 (824 – 894 MHz)
	GSM 900 (880 – 960 MHz)
	GSM 1800 (1710 – 1880 MHz)
	GSM 1900 (1850 – 1990 MHz)
UMTS/LTE	Band 1 (1920 – 2170 MHz)
	Band 2 (1850 – 1990 MHz)
	Band 3 (1710 – 1880 MHz)
	Band 4 (1710 – 2155 MHz)
	Band 5 (824 – 894 MHz)
	Band 6 (830 – 883 MHz)
	Band 8 (880 – 960 MHz)
	NB-IoT
Band 20 (791 – 862 MHz)	

Ordering information

Part number	Part name	Details
PRO-IS-577	InSide GSM/NB-IoT Flex, 100 mm MHF	Antenna for NB-IoT and GSM. 100 mm cable with MHF (U.FL) connector.

For information on sales, delivery terms and conditions and prices, please visit the Proant website (www.proant.se) for a complete list of distributors.

Proant offers consultation with design-in of the InSide antennas. Proant have all necessary capabilities for antenna design including anechoic chamber and prototype workshop. Please send your requests to info@proant.se.

Disclaimer

The information given in this application note shall in no event be regarded as a guarantee of conditions or characteristics. With respect to any examples or hints given herein, any typical values stated herein and/or any information regarding the application of the device, Proant AB hereby disclaims any and all warranties and liabilities of any kind, including without limitation, warranties of non-infringement of intellectual property rights of any third party.