

Cable - VIP-CAB-FLK14/16/3,0M/S7 - 2904519

Please be informed that the data shown in this PDF Document is generated from our Online Catalog. Please find the complete data in the user's documentation. Our General Terms of Use for Downloads are valid (<http://phoenixcontact.com/download>)



Round cable set; controller: SIMATIC® TOP connect; connection 1: IDC/FLK socket strip (1x 16-position); connection 2: IDC/FLK socket strip (1x 14-position); cable length: 3 m

Key Commercial Data

Packing unit	1 pc
GTIN	
GTIN	4046356859394

Technical data

General

Max. permissible operating voltage	< 50 V AC
	60 V DC
Max. current carrying capacity per path	1 A
Length of cable	3 m
External cable diameter	6.4 mm
Single wire, cross section	0.14 mm ²
Single wire, cross section [AWG]	26
Single wire, number of litz wires	7
Single wire, material	Cu tin-plated
Cable, preassembly	Insulation displacement, IEC 60352-4/DIN EN 60352-4
Shielding	no
Cable capacity	120 pF/m
Outer sheath, material	PVC
External sheath, color	gray RAL 7035

Environmental conditions

Ambient temperature (operation)	-20 °C ... 50 °C
Ambient temperature (storage/transport)	-20 °C ... 70 °C

Cable - VIP-CAB-FLK14/16/3,0M/S7 - 2904519

Technical data

Environmental conditions

Flame resistance	IEC 60332-1
	DIN VDE 0482 Part 332-1
Resistance to oil	UL 1581
Gasoline resistance	against occasional splashes

Connector 1

Connection name	Field level
Connection method	IDC/FLK socket strip
Number of connections	1
Number of positions	14
Pitch	2.54 mm

Connector 2

Connection name	Controller level
Connection method	IDC/FLK socket strip
Number of connections	1
Number of positions	16
Pitch	2.54 mm

Supported controller

Controller	SIEMENS TOP connect
------------	---------------------

Standards and Regulations

Flame resistance	IEC 60332-1
	DIN VDE 0482 Part 332-1
Resistance to oil	UL 1581
Gasoline resistance	against occasional splashes
Connection in acc. with standard	CUL

Environmental Product Compliance

China RoHS	Environmentally Friendly Use Period = 50 years
	For details about hazardous substances go to tab "Downloads", Category "Manufacturer's declaration"

Drawings

Cable - VIP-CAB-FLK14/16/3,0M/S7 - 2904519

Connection diagram

14-pos. Socket strip PIN	16-pos. Socket strip PIN	Wire color
1	16	Black
2	14	Brown
3	12	Red
4	10	Orange
5	8	Yellow
6	6	Green
7	4	Blue
8	2	Violet
9	9	Gray
10	1	White
11	11	White-black
12	3	White-brown
13	13	White-red
14	5	White-orange
	7	-
	15	-

Pin assignment and color code

Cable - VIP-CAB-FLK14/16/3,0M/S7 - 2904519

Dimensional drawing

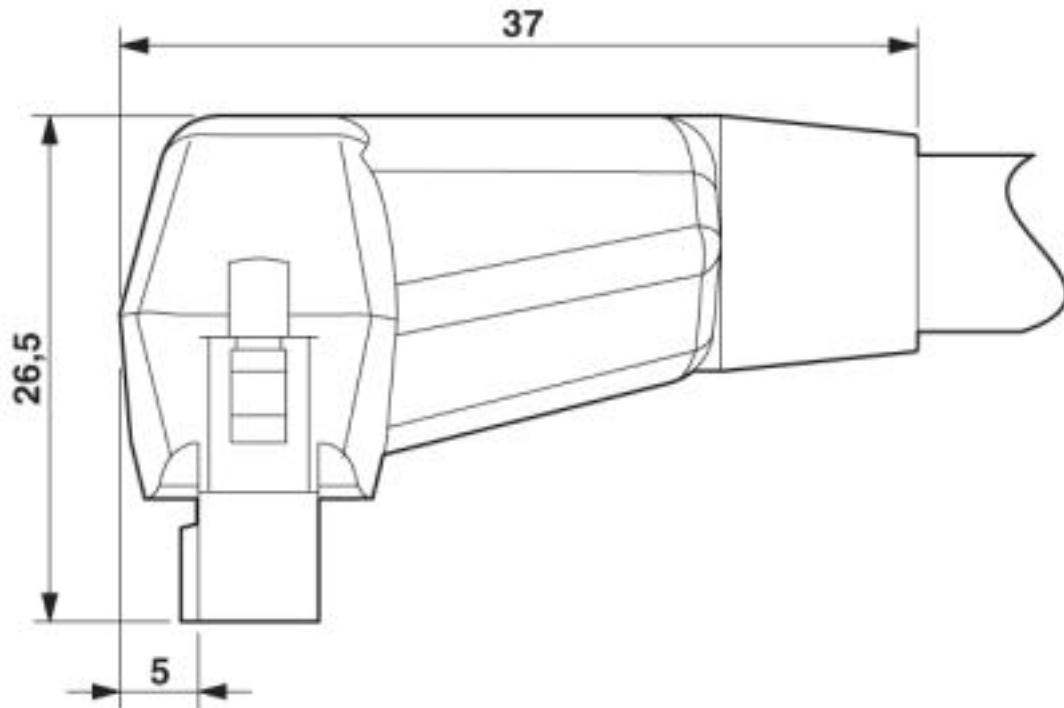

Classifications

eCl@ss

eCl@ss 5.1	27242200
eCl@ss 6.0	27249200
eCl@ss 7.0	27249205
eCl@ss 8.0	27249205
eCl@ss 9.0	27242220

ETIM

ETIM 2.0	EC000237
ETIM 3.0	EC000237
ETIM 4.0	EC000237
ETIM 5.0	EC000237
ETIM 6.0	EC000237

UNSPSC

UNSPSC 6.01	26121620
UNSPSC 7.0901	26121620
UNSPSC 11	26121620
UNSPSC 12.01	26121620
UNSPSC 13.2	26121620
UNSPSC 19.0	26121620

Phoenix Contact 2020 © - all rights reserved
<http://www.phoenixcontact.com>

PHOENIX CONTACT GmbH & Co. KG
Flachsmarktstr. 8
32825 Blomberg
Germany
Tel. +49 5235 300
Fax +49 5235 3 41200
<http://www.phoenixcontact.com>