

Sensor/actuator cable - SAC-4P-M12MR/.../... - 1696950

Please be informed that the data shown in this PDF Document is generated from our Online Catalog. Please find the complete data in the user's documentation. Our General Terms of Use for Downloads are valid (<http://phoenixcontact.com/download>)



Sensor/actuator cable, 4-position, Variable cable type, Plug angled M12, coding: A, on free cable end, cable length: Free input (0.2 ... 40.0 m)

Your advantages

- ✓ Easy and safe: 100% electrically tested plug-in components
- ✓ Flexible solutions - configurable materials with variable cable types and cable lengths

Key Commercial Data

Packing unit	1 pc
Minimum order quantity	25 pc

Technical data

Dimensions

Length of cable	Free input (0.2 ... 40.0 m)
Stripping length of the free conductor end	50 mm

Ambient conditions

Ambient temperature (operation)	-25 °C ... 90 °C (Plug / socket)
Degree of protection	IP65
	IP67
	IP68

General

Rated current at 40°C	4 A
Rated voltage	250 V AC
	250 V DC
Number of positions	4
Insulation resistance	≥ 100 MΩ
Coding	A - standard
Standards/regulations	M12 connector IEC 61076-2-101
Status display	No
Protective circuit/component	unwired
Overvoltage category	II
Degree of pollution	3

Sensor/actuator cable - SAC-4P-M12MR/.../... - 1696950

Technical data

General

Insertion/withdrawal cycles	≥ 100
Torque	0.4 Nm (M12 connector)

Material

Flammability rating according to UL 94	HB
Contact material	CuSn
Contact surface material	Ni/Au
Contact carrier material	TPU GF
Material of grip body	TPU, hardly inflammable, self-extinguishing
Material, knurls	Zinc die-cast, nickel-plated

Line characteristics

Note	This item is a sensor/actuator cable with a freely selectable cable type. The technical data for all possible cable types is listed in the table below.
------	---

Standards and Regulations

Standards/specifications	M12 connector IEC 61076-2-101
Flammability rating according to UL 94	HB

PUR/PVC yellow [140]

Cable type	PUR/PVC yellow
Cable type (abbreviation)	140
Cable abbreviation	LiYY-11Y
UL AWM style	20549
Conductor cross section	0.34 mm ²
AWG signal line	22
Conductor structure signal line	42x 0.10 mm
Core diameter including insulation	1.5 mm ±0.05 mm
Thickness, insulation	approx. 0.3 mm (Core insulation)
	≥ 0.38 mm (Outer cable sheath)
	approx. 0.35 mm (Inner sheath)
Wire colors	brown, white, blue, black
Overall twist	4 wires, twisted
External sheath, color	yellow
External cable diameter D	5.2 mm ±0.2 mm
Smallest bending radius, fixed installation	52 mm
Smallest bending radius, movable installation	52 mm
Number of bending cycles	2000000
Bending radius	52 mm
Traversing path	5 m
Traversing rate	3 m/s
Cable weight	39 kg/km
Outer sheath, material	PUR

Sensor/actuator cable - SAC-4P-M12MR/.../... - 1696950

Technical data

PUR/PVC yellow [140]

Material, inner sheath	PVC
Material conductor insulation	PVC
Conductor material	Bare Cu litz wires
Insulation resistance	≥ 1 GΩ*km (at 20 °C)
Conductor resistance	max. 58 Ω/km (at 20 °C)
Nominal voltage, cable	≤ 300 V
Test voltage, cable	≥ 3000 V
Flame resistance	in accordance with DIN UL-Style 20549
Ambient temperature (operation)	-25 °C ... 80 °C (cable, fixed installation)
	-5 °C ... 80 °C (cable, flexible installation)

PUR irradiated halogen-free orange [150]

Cable type	PUR irradiated halogen-free orange
Cable type (abbreviation)	150
Cable abbreviation	D12YSL11X-OB
Conductor cross section	4x 0.34 mm ²
AWG signal line	22
Conductor structure signal line	19x 0.15 mm
Core diameter including insulation	1.05 mm ±0.05 mm (Signal line)
Wire colors	brown, white, blue, black
Overall twist	4 wires, twisted
Length of twist, overall twist	27 mm
External sheath, color	orange RAL 2003
External cable diameter D	5.2 mm ±0.2 mm
Smallest bending radius, fixed installation	min. 15 mm
Smallest bending radius, movable installation	min. 30 mm
Number of bending cycles	5000000
Bending radius	52 mm
Traversing path	10 m
Traversing rate	3 m/s
Torsion force	± 360 °/m
Outer sheath, material	PUR
Material conductor insulation	PE
Conductor material	Bare Cu litz wires
Conductor resistance	max. 57 Ω/km
Nominal voltage, cable	320 V (AC)
Test voltage, cable	2500 V (50 Hz, 5 minutes)
Special properties	Silicone-free
	Irradiated
Halogen-free	The cable is halogen-free
Other resistance	hydrolysis and microbe resistant

Sensor/actuator cable - SAC-4P-M12MR/.../... - 1696950

Technical data

PUR irradiated halogen-free orange [150]

	Resistant to welding splashes
Ambient temperature (operation)	-50 °C ... 105 °C (cable, fixed installation)
	-40 °C ... 105 °C (cable, flexible installation)

PUR irradiated halogen-free yellow [160]

Cable type	PUR irradiated halogen-free yellow
Cable type (abbreviation)	160
Cable abbreviation	D12YSL11X-OB
Conductor cross section	4x 0.34 mm ² (Signal line)
AWG signal line	22
Conductor structure signal line	19x 0.15 mm
Core diameter including insulation	1.05 mm ±0.05 mm (Signal line)
Wire colors	brown, white, blue, black
Overall twist	4 wires, twisted
Length of twist, overall twist	27 mm
External sheath, color	yellow
External cable diameter D	5.2 mm ±0.2 mm
Smallest bending radius, fixed installation	min. 15 mm
Smallest bending radius, movable installation	min. 30 mm
Number of bending cycles	5000000
Bending radius	52 mm
Traversing path	10 m
Traversing rate	3 m/s
Torsion force	360 °/m
Outer sheath, material	PUR
Material conductor insulation	PE
Conductor material	Bare Cu litz wires
Conductor resistance	≤ 57 Ω/km
Nominal voltage, cable	320 V AC
Test voltage, cable	2500 V AC (50 Hz, 5 minutes)
Special properties	Silicone-free
	Irradiated
Flame resistance	DIN VDE 0472 part 804, test type B
Halogen-free	The cable is halogen-free
Other resistance	hydrolysis and microbe resistant
Ambient temperature (operation)	-50 °C ... 105 °C (cable, fixed installation)
	-40 °C ... 105 °C (cable, flexible installation)

PUR halogen-free orange [180]

Cable type	PUR halogen-free orange
Cable type (abbreviation)	180
Cable abbreviation	Li9Y-11Y

Sensor/actuator cable - SAC-4P-M12MR/.../... - 1696950

Technical data

PUR halogen-free orange [180]

UL AWM style	20549
Conductor cross section	4x 0.34 mm ² (Signal line)
AWG signal line	22
Conductor structure signal line	42x 0.10 mm
Core diameter including insulation	1.27 mm ±0.02 mm (Signal line)
Thickness, insulation	≥ 0.21 mm (Core insulation)
	approx. 0.8 mm (Outer cable sheath)
Wire colors	brown, white, blue, black
Overall twist	4 wires, twisted
External sheath, color	orange RAL 2003
External cable diameter D	4.7 mm ±0.15 mm
Smallest bending radius, fixed installation	23.5 mm
Smallest bending radius, movable installation	47 mm
Number of bending cycles	4000000
Bending radius	47 mm
Traversing path	10 m
Traversing rate	3 m/s
Acceleration	10 m/s ²
Cable weight	30 kg/km
Outer sheath, material	PUR
Material conductor insulation	PP
Conductor material	Bare Cu litz wires
Insulation resistance	≥ 1 GΩ*km (at 20 °C)
Conductor resistance	max. 58 Ω/km (at 20 °C)
Nominal voltage, cable	≤ 300 V
Test voltage, cable	≥ 3000 V
Special properties	Free of substances which would hinder coating with paint or varnish
Flame resistance	in accordance with UL 758/1581 FT2
Halogen-free	in accordance with DIN VDE 0472 part 815
	in accordance with DIN EN 50267-2-1
Resistance to oil	in accordance with DIN EN 60811-2-1
Other resistance	Resistant to salt water
	hydrolysis and microbe resistant
Ambient temperature (operation)	-40 °C ... 80 °C (cable, fixed installation)
	-25 °C ... 80 °C (cable, flexible installation)

PUR POWER 0.75 mm² black [186]

Cable type	PUR POWER 0.75 mm ² black
Cable type (abbreviation)	186
Cable abbreviation	LiY11Y
UL AWM style	20549 / 1061 (80°C/300 V)

Sensor/actuator cable - SAC-4P-M12MR/.../... - 1696950

Technical data

PUR POWER 0.75 mm² black [186]

Conductor cross section	4x 0.75 mm ² (power line)
AWG signal line	18
Conductor structure signal line	42x 0.15 mm
Core diameter including insulation	1.75 mm ±0.05 mm
Thickness, insulation	≥ 0.23 mm (Core insulation)
	≥ 0.76 mm (Outer cable sheath)
Wire colors	brown, white, blue, black
Overall twist	4 wires, twisted
External sheath, color	black-gray RAL 7021
External cable diameter D	5.9 mm ±0.15 mm
Smallest bending radius, movable installation	59 mm
Minimum bending radius, fixed installation	5 x D
Minimum bending radius, flexible installation	10 x D
Number of bending cycles	2000000
Bending radius	59 mm
Traversing path	5 m
Traversing rate	3 m/s
Acceleration	5 m/s ²
Cable weight	57 kg/km
Outer sheath, material	PUR
Material conductor insulation	PVC
Conductor material	Bare Cu litz wires
Insulation resistance	≥ 1 MΩ*km (at 20 °C)
Conductor resistance	max. 26 Ω/km (at 20 °C)
Nominal voltage, cable	≤ 300 V
Test voltage, cable	≥ 3000 V
Flame resistance	according to UL 758/1581 (horizontal)
	in accordance with UL 758/1581 FT2
Resistance to oil	According to DIN EN 60811-2-1, 168 h at 100°C
Other resistance	hydrolysis and microbe resistant
	Low adhesion
	abrasion-resistant
	Resistant to salt water
Ambient temperature (operation)	-25 °C ... 80 °C (cable, fixed installation)
	-5 °C ... 80 °C (cable, flexible installation)

PUR halogen-free yellow [240]

Cable type	PUR halogen-free yellow
Cable type (abbreviation)	240
Cable abbreviation	Li9Y11Y
Conductor cross section	4x 0.34 mm ²

Sensor/actuator cable - SAC-4P-M12MR/.../... - 1696950

Technical data

PUR halogen-free yellow [240]

AWG signal line	22
Conductor structure signal line	42x 0.10 mm
Core diameter including insulation	1.27 mm ±0.02 mm
Thickness, insulation	≥ 0.21 mm (Core insulation)
	approx. 0.8 mm (Outer cable sheath)
Wire colors	brown, white, blue, black
Overall twist	4 wires, twisted
Length of twist, overall twist	49.5 mm
External sheath, color	yellow
External cable diameter D	4.7 mm ±0.15 mm
Smallest bending radius, fixed installation	23.5 mm
Smallest bending radius, movable installation	47 mm
Number of bending cycles	4000000
Bending radius	47 mm
Traversing path	10 m
Traversing rate	3 m/s
Acceleration	10 m/s ²
Cable weight	30 kg/km
Outer sheath, material	PUR
Material conductor insulation	PP
Conductor material	Bare Cu litz wires
Insulation resistance	≥ 1 GΩ*km (at 20 °C)
Conductor resistance	max. 58 Ω/km (at 20 °C)
Nominal voltage, cable	≤ 300 V
Test voltage, cable	≥ 3000 V
Special properties	Flexible cable conduit capable
	Silicone-free
	Free of substances which would hinder coating with paint or varnish
Flame resistance	in accordance with DIN UL-Style 20549
	in accordance with FT1 as per UL 758
Halogen-free	in accordance with DIN VDE 0472 part 815
	in accordance with DIN EN 50267-2-1
Resistance to oil	in accordance with DIN EN 60811-2-1
Other resistance	Highly resistant to acids, alkaline solutions and solvents
	hydrolysis and microbe resistant
Ambient temperature (operation)	-40 °C ... 80 °C (cable, fixed installation)
	-25 °C ... 80 °C (cable, flexible installation)

PUR halogen-free gray [280]

Cable type	PUR halogen-free gray
Cable type (abbreviation)	280

Sensor/actuator cable - SAC-4P-M12MR/.../... - 1696950

Technical data

PUR halogen-free gray [280]

Cable abbreviation	Li9Y11Y-HF
UL AWM style	20549 / 10493 (80°C/300 V)
Conductor cross section	4x 0.34 mm ²
AWG signal line	22
Conductor structure signal line	42x 0.10 mm
Core diameter including insulation	1.27 mm ±0.02 mm
Thickness, insulation	≥ 0.21 mm
Wire colors	brown, white, blue, black
Overall twist	4 wires, twisted
External sheath, color	gray RAL 7001
Outer sheath thickness	approx. 0.5 mm
External cable diameter D	4.2 mm ±0.15 mm
Minimum bending radius, fixed installation	5 x D
Minimum bending radius, flexible installation	10 x D
Number of bending cycles	10000000
Minimum bending radius, drag chain applications	10 x D
Traversing path	10 m
Traversing rate	3 m/s
Acceleration	10 m/s ²
Cable weight	30 kg/km
Outer sheath, material	PUR
Material conductor insulation	PP
Conductor material	Bare Cu litz wires
Insulation resistance	≥ 1 GΩ*km
Conductor resistance	≤ 58 Ω/km
Nominal voltage, cable	≤ 300 V
Test voltage, cable	≥ 3000 V
Special properties	Flexible cable conduit capable
	Silicone-free
	Free of substances which would hinder coating with paint or varnish
	flexible
Flame resistance	in accordance with UL 758/1581 FT2
	DIN EN 60332-2-2 (20 s)
Halogen-free	in accordance with DIN VDE 0472 part 815
	in accordance with DIN EN 50267-2-1
Resistance to oil	in accordance with DIN EN 60811-2-1
Other resistance	Highly resistant to acids, alkaline solutions and solvents
	hydrolysis and microbe resistant
	partly UV-resistant in accordance with DIN EN ISO 4892-2-A
	Low adhesion

Sensor/actuator cable - SAC-4P-M12MR/.../... - 1696950

Technical data

PUR halogen-free gray [280]

	abrasion-resistant
Ambient temperature (operation)	-40 °C ... 80 °C (cable, fixed installation)
	-25 °C ... 80 °C (cable, flexible installation)

PVC gray [500]

Cable type	PVC gray
Cable type (abbreviation)	500
Cable abbreviation	LiYY
Conductor cross section	0.34 mm ²
AWG signal line	22
Conductor structure signal line	42x 0.10 mm
Core diameter including insulation	1.45 mm ±0.02 mm
Thickness, insulation	≥ 0.23 mm (Core insulation)
	≥ 0.76 mm (Outer cable sheath)
Wire colors	brown, white, blue, black
Overall twist	4 wires, twisted
External sheath, color	gray RAL 7001
External cable diameter D	5.2 mm ±0.15 mm
Smallest bending radius, fixed installation	26 mm
Smallest bending radius, movable installation	52 mm
Cable weight	40 kg/km
Outer sheath, material	PVC
Material conductor insulation	PVC
Conductor material	Bare Cu litz wires
Insulation resistance	≥ 1 GΩ*km (at 20 °C)
Conductor resistance	max. 58 Ω/km (at 20 °C)
Nominal voltage, cable	≤ 300 V (AC)
Test voltage, cable	≥ 3000 V (AC)
Flame resistance	in accordance with FT1 as per UL 758
Resistance to oil	in accordance with DIN EN 60811-2-1
Ambient temperature (operation)	-40 °C ... 80 °C (cable, fixed installation)
	-25 °C ... 80 °C (cable, flexible installation)

PVC yellow [540]

Cable type	PVC yellow
Cable type (abbreviation)	540
Cable abbreviation	LiYY
Conductor cross section	0.34 mm ²
AWG signal line	22
Conductor structure signal line	42x 0.10 mm
Core diameter including insulation	1.45 mm ±0.05 mm
Thickness, insulation	≥ 0.23 mm (Core insulation)

Sensor/actuator cable - SAC-4P-M12MR/.../... - 1696950

Technical data

PVC yellow [540]

	≥ 0.76 mm (Outer cable sheath)
Wire colors	brown, white, blue, black
Overall twist	4 wires, twisted
External sheath, color	yellow
External cable diameter D	5.2 mm ±0.15 mm
Cable weight	40 kg/km
Outer sheath, material	PVC
Material conductor insulation	PVC
Conductor material	Bare Cu litz wires
Insulation resistance	≥ 1 GΩ*km (at 20 °C)
Conductor resistance	max. 58 Ω/km (at 20 °C)
Nominal voltage, cable	≤ 300 V (AC)
Test voltage, cable	≥ 3000 V
Flame resistance	As per UL-Style 2464
	according to UL 758/1581 FT1
Resistance to oil	in accordance with DIN EN 60811-2-1
Ambient temperature (operation)	-40 °C ... 80 °C (cable, fixed installation)
	-25 °C ... 80 °C (cable, flexible installation)

PVC yellow 105 °C [542]

Cable type	PVC yellow 105 °C
Cable type (abbreviation)	542
Cable abbreviation	LiYY
Conductor cross section	0.34 mm ²
AWG signal line	22
Conductor structure signal line	42x 0.10 mm
Core diameter including insulation	1.55 mm ±0.05 mm
Thickness, insulation	≥ 0.38 mm (Core insulation)
	≥ 0.76 mm (Outer cable sheath)
Wire colors	brown, white, blue, black
Overall twist	4 wires, twisted
External sheath, color	yellow
External cable diameter D	5.5 mm ±0.2 mm
Cable weight	43 kg/km
Outer sheath, material	PVC
Material conductor insulation	PVC
Conductor material	Bare Cu litz wires
Insulation resistance	≥ 100 MΩ*km (at 20 °C)
Conductor resistance	≤ 58 Ω/km (at 20 °C)
Nominal voltage, cable	≤ 300 V
Test voltage, cable	≥ 3000 V

Sensor/actuator cable - SAC-4P-M12MR/.../... - 1696950

Technical data

PVC yellow 105 °C [542]

Flame resistance	in accordance with UL-Style 2517
	in acc. to UL VW1
Ambient temperature (operation)	-25 °C ... 105 °C (cable, fixed installation)

Gray, highly flexible PUR [800]

Note	Due to the extremely robust outer sheath, this cable should only be stripped in 5 cm increments.
Cable type	Gray, highly flexible PUR
Cable type (abbreviation)	800
Cable abbreviation	LiF9Y11Y
UL AWM style	20549
Conductor cross section	4x 0.34 mm ² (Signal line)
AWG signal line	22
Conductor structure signal line	42x 0.10 mm
Core diameter including insulation	1.3 mm ±0.05 mm (Signal line)
Wire colors	brown, white, blue, black
Overall twist	4 wires, twisted
External sheath, color	gray RAL 7001
External cable diameter D	4.8 mm ±0.2 mm
Minimum bending radius, fixed installation	4 x D
Minimum bending radius, flexible installation	7.5 x D
Number of bending cycles	10000000
Minimum bending radius, drag chain applications	7,5 x D
Traversing path	5 m
Traversing rate	3.3 m/s
Acceleration	5 m/s ²
Number of bending cycles	15000000
Bending radius	50 mm
Traversing path	0.9 m
Traversing rate	5 m/s
Acceleration	30 m/s ²
Torsion force	± 360 °/m (1 000 000 torsion cycles)
Cable weight	33.5 kg/km
Outer sheath, material	PUR
Material conductor insulation	PP
Conductor material	Bare Cu litz wires
Insulation resistance	≥ 20 MΩ*km
Conductor resistance	approx. 53 Ω/km
Nominal voltage, cable	300 V
Test voltage, cable	2000 V
Special properties	Cable jacket is welding spark-resistant, recyclable, matt, low-adhesion, abrasion-resistant, flame-retardant, and self-extinguishing

Sensor/actuator cable - SAC-4P-M12MR/.../... - 1696950

Technical data

Gray, highly flexible PUR [800]

	Free from silicone and cadmium
	Free of substances which would hinder coating with paint or varnish
Flame resistance	in accordance with UL 758/1581 FT2
Halogen-free	in accordance with DIN VDE 0472 part 815
Resistance to oil	in accordance with DIN EN 60811-2-1
Other resistance	Highly resistant to acids, alkaline solutions and solvents
	Silicone-free
Ambient temperature (operation)	-40 °C ... 80 °C (cable, fixed installation)
	-25 °C ... 80 °C (cable, flexible installation)

PUR halogen-free black [PUR]

Cable type	PUR halogen-free black
Cable type (abbreviation)	PUR
Cable abbreviation	Li9Y11Y-HF
UL AWM style	20549 / 10493 (80°C/300 V)
Conductor cross section	4x 0.34 mm ²
AWG signal line	22
Conductor structure signal line	42x 0.10 mm
Core diameter including insulation	1.27 mm ±0.02 mm
Thickness, insulation	≥ 0.21 mm
Wire colors	brown, white, blue, black
Overall twist	4 wires, twisted
External sheath, color	black-gray RAL 7021
Outer sheath thickness	approx. 0.5 mm
External cable diameter D	4.2 mm ±0.15 mm
Minimum bending radius, fixed installation	5 x D
Minimum bending radius, flexible installation	10 x D
Number of bending cycles	10000000
Minimum bending radius, drag chain applications	10 x D
Traversing path	10 m
Traversing rate	3 m/s
Acceleration	10 m/s ²
Cable weight	30 kg/km
Outer sheath, material	PUR
Material conductor insulation	PP
Conductor material	Bare Cu litz wires
Insulation resistance	≥ 1 GΩ*km
Conductor resistance	≤ 58 Ω/km
Nominal voltage, cable	≤ 300 V
Test voltage, cable	≥ 3000 V
Special properties	Flexible cable conduit capable

Sensor/actuator cable - SAC-4P-M12MR/.../... - 1696950

Technical data

PUR halogen-free black [PUR]

	Silicone-free
	Free of substances which would hinder coating with paint or varnish
	flexible
Flame resistance	in accordance with UL 758/1581 FT2
	DIN EN 60332-2-2 (20 s)
Halogen-free	in accordance with DIN VDE 0472 part 815
	in accordance with DIN EN 50267-2-1
Resistance to oil	in accordance with DIN EN 60811-2-1
Other resistance	Highly resistant to acids, alkaline solutions and solvents
	hydrolysis and microbe resistant
	partly UV-resistant in accordance with DIN EN ISO 4892-2-A
	Low adhesion
	abrasion-resistant
Ambient temperature (operation)	-40 °C ... 80 °C (cable, fixed installation)
	-25 °C ... 80 °C (cable, flexible installation)

PVC black [PVC]

Cable type	PVC black
Cable type (abbreviation)	PVC
Cable abbreviation	LiYY
UL AWM style	2464 / 1729 (80°C/300 V)
Conductor cross section	4x 0.34 mm ² (Signal line)
AWG signal line	22
Conductor structure signal line	42x 0.10 mm
Core diameter including insulation	1.45 mm ±0.02 mm
Thickness, insulation	≥ 0.23 mm (Core insulation)
Wire colors	brown, white, blue, black
Overall twist	4 wires, twisted
External sheath, color	black RAL 9005
Outer sheath thickness	≥ 0.76 mm
External cable diameter D	5.2 mm ±0.15 mm
Minimum bending radius, fixed installation	5 x D
Minimum bending radius, flexible installation	10 x D
Cable weight	40 kg/km
Outer sheath, material	PVC
Material conductor insulation	PVC
Conductor material	Bare Cu litz wires
Insulation resistance	≥ 200 MΩ*km (at 20 °C)
Conductor resistance	max. 58 Ω/km (at 20 °C)
Nominal voltage, cable	≤ 300 V
Test voltage, cable	≥ 3000 V

Sensor/actuator cable - SAC-4P-M12MR/.../... - 1696950

Technical data

PVC black [PVC]

Flame resistance	according to UL 758/1581 FT1
	According to UL 758/1581 (Cable Flame)
	According to DIN EN 60332-1-2
Resistance to oil	according to DIN EN 60811-2-1, 168 h at 60 °C
Ambient temperature (operation)	-40 °C ... 80 °C (cable, fixed installation)
	-25 °C ... 80 °C (cable, flexible installation)

Environmental Product Compliance

China RoHS	Environmentally friendly use period: unlimited = EFUP-e
	No hazardous substances above threshold values

Drawings

Dimensional drawing

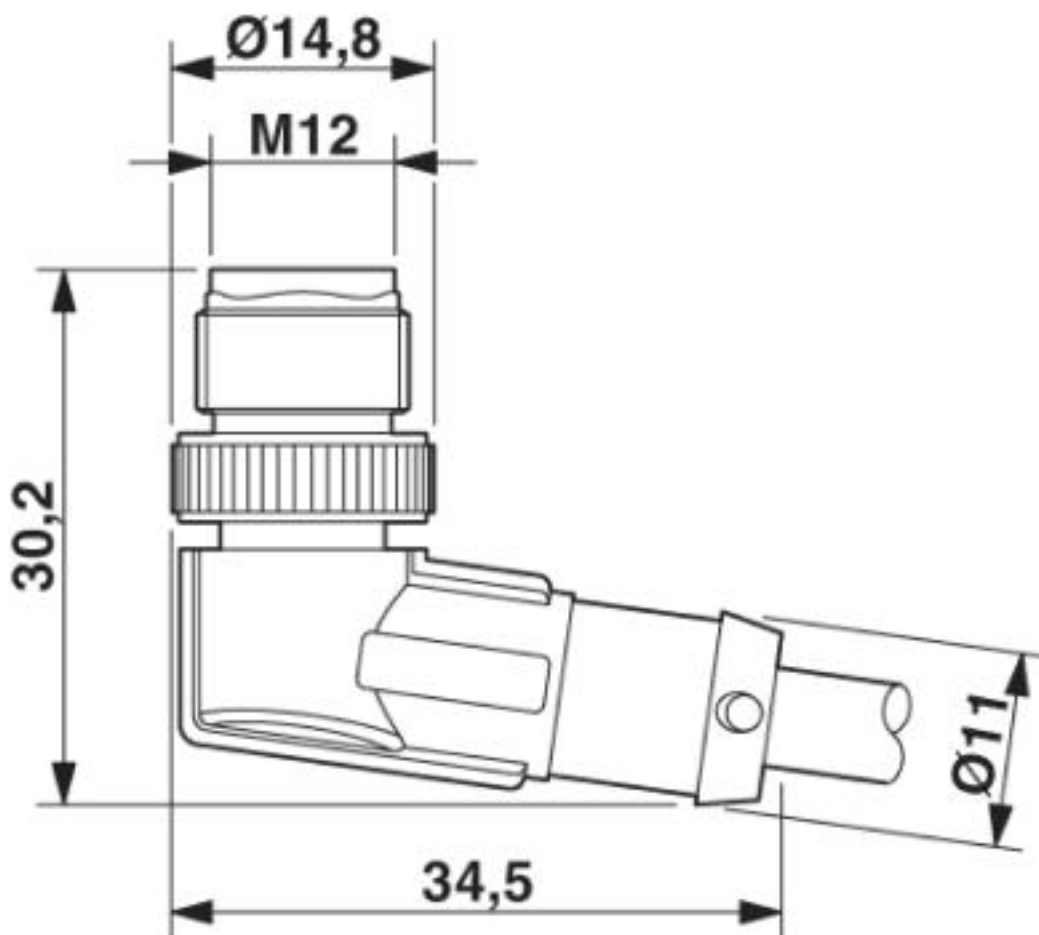

M12 x 1 male plug, angled

Sensor/actuator cable - SAC-4P-M12MR/.../... - 1696950

Circuit diagram

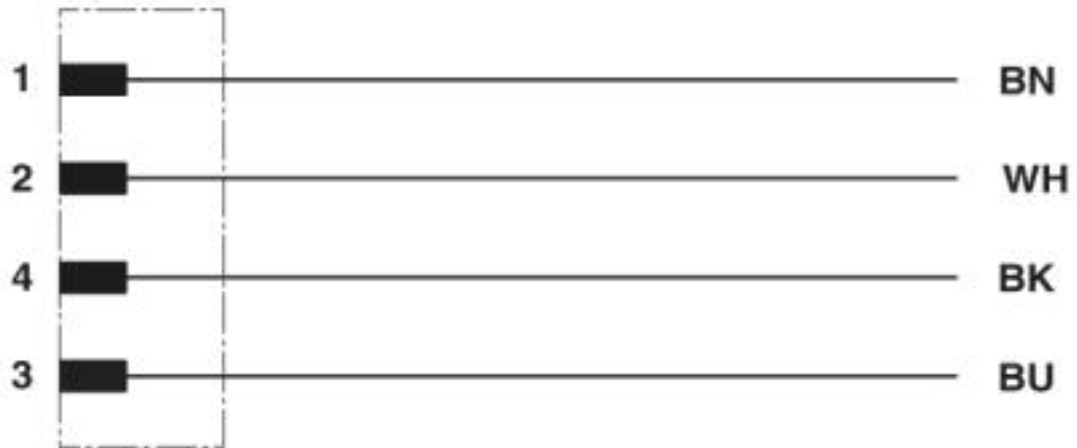

Contact assignment of the M12 plug

Sensor/actuator cable - SAC-4P-M12MR/.../... - 1696950

Schematic diagram

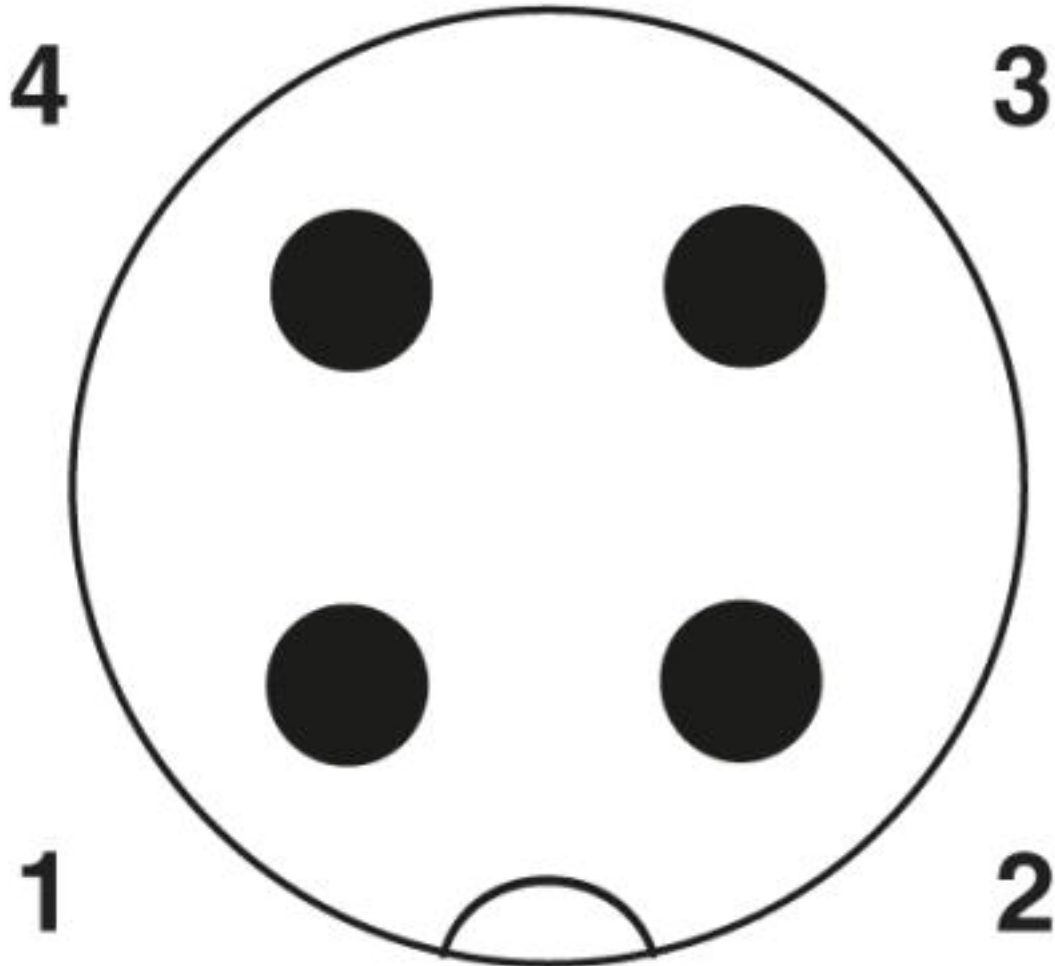

Pin assignment M12 plug, 4-pos., A-coded, view plug side

Sensor/actuator cable - SAC-4P-M12MR/.../... - 1696950

Cable cross section

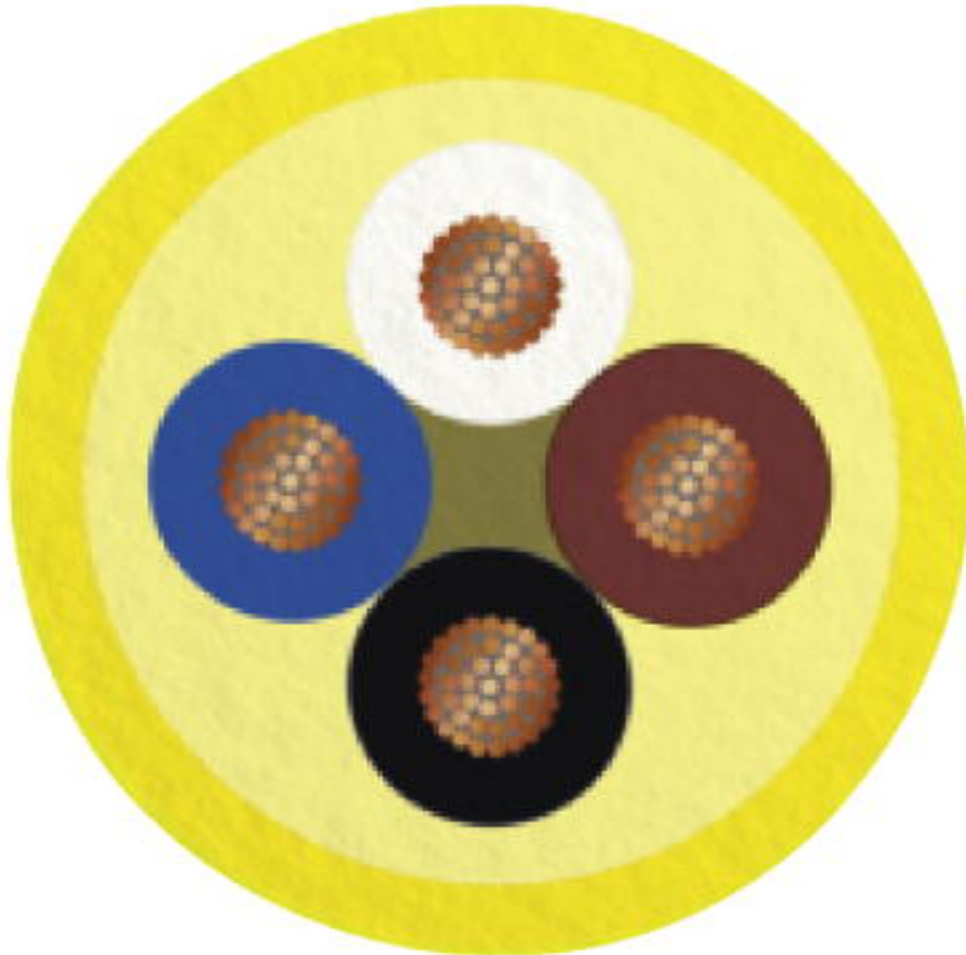

PUR/PVC yellow [140]

Sensor/actuator cable - SAC-4P-M12MR/.../... - 1696950

Cable cross section

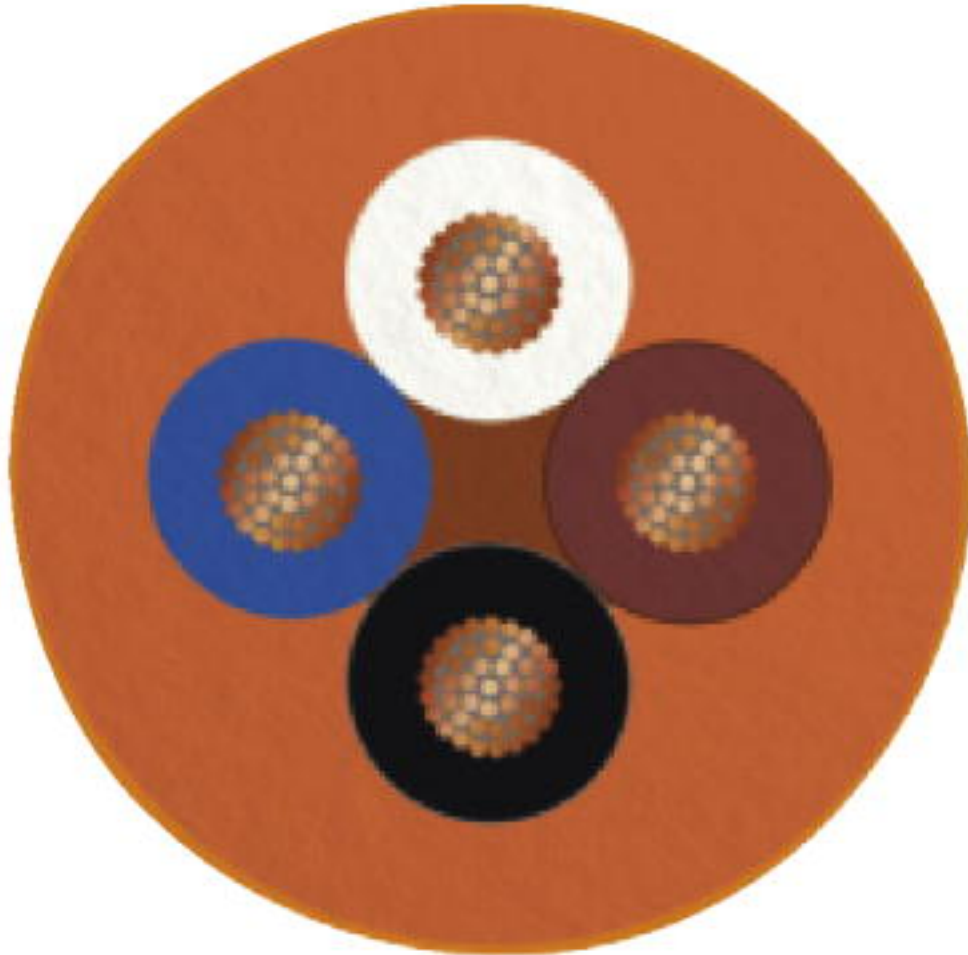

PUR irradiated halogen-free orange [150]

Sensor/actuator cable - SAC-4P-M12MR/.../... - 1696950

Cable cross section

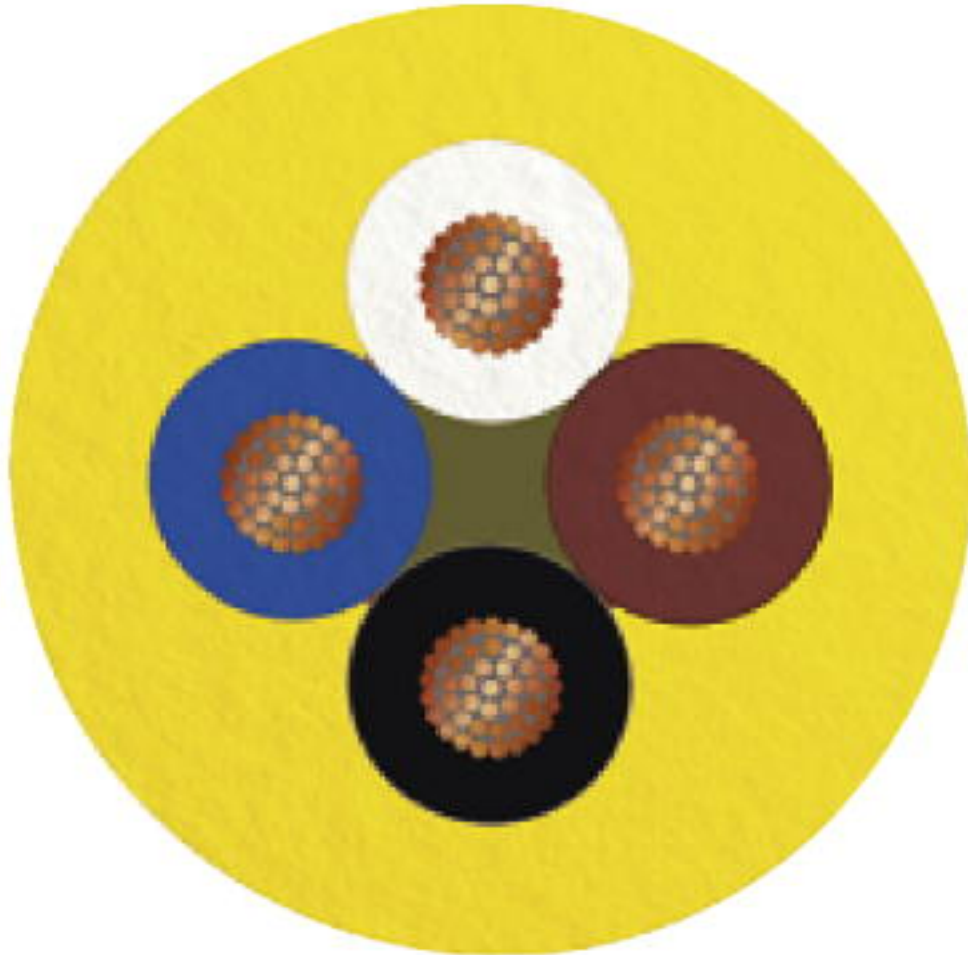

PUR irradiated halogen-free yellow [160]

Sensor/actuator cable - SAC-4P-M12MR/.../... - 1696950

Cable cross section

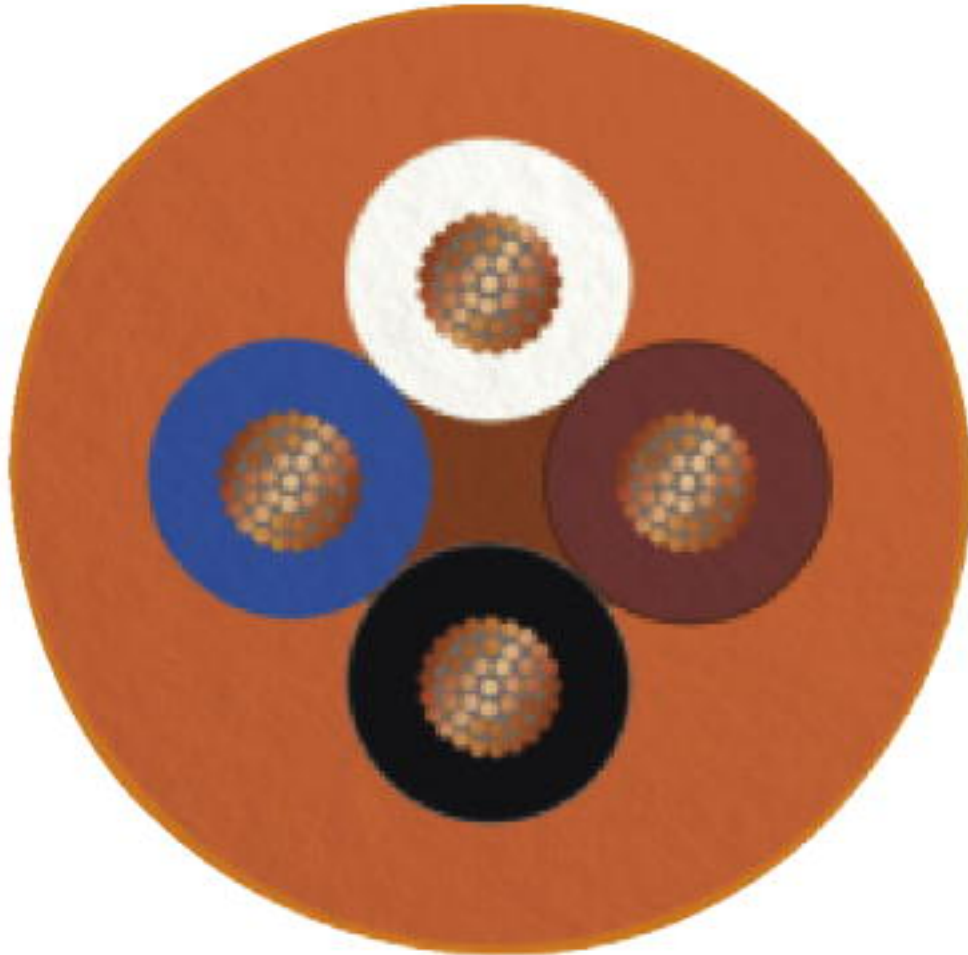

PUR halogen-free orange [180]

Sensor/actuator cable - SAC-4P-M12MR/.../... - 1696950

Cable cross section

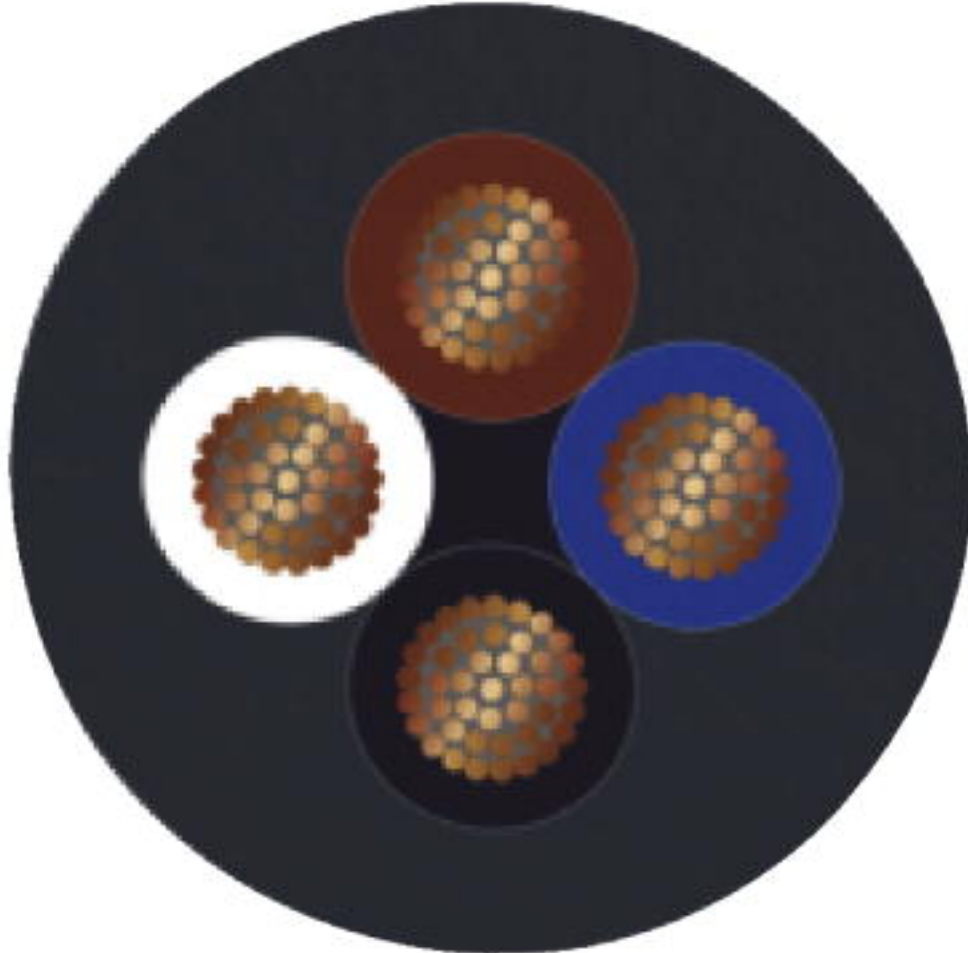

PUR POWER 0.75 mm² black [186]

Sensor/actuator cable - SAC-4P-M12MR/.../... - 1696950

Cable cross section

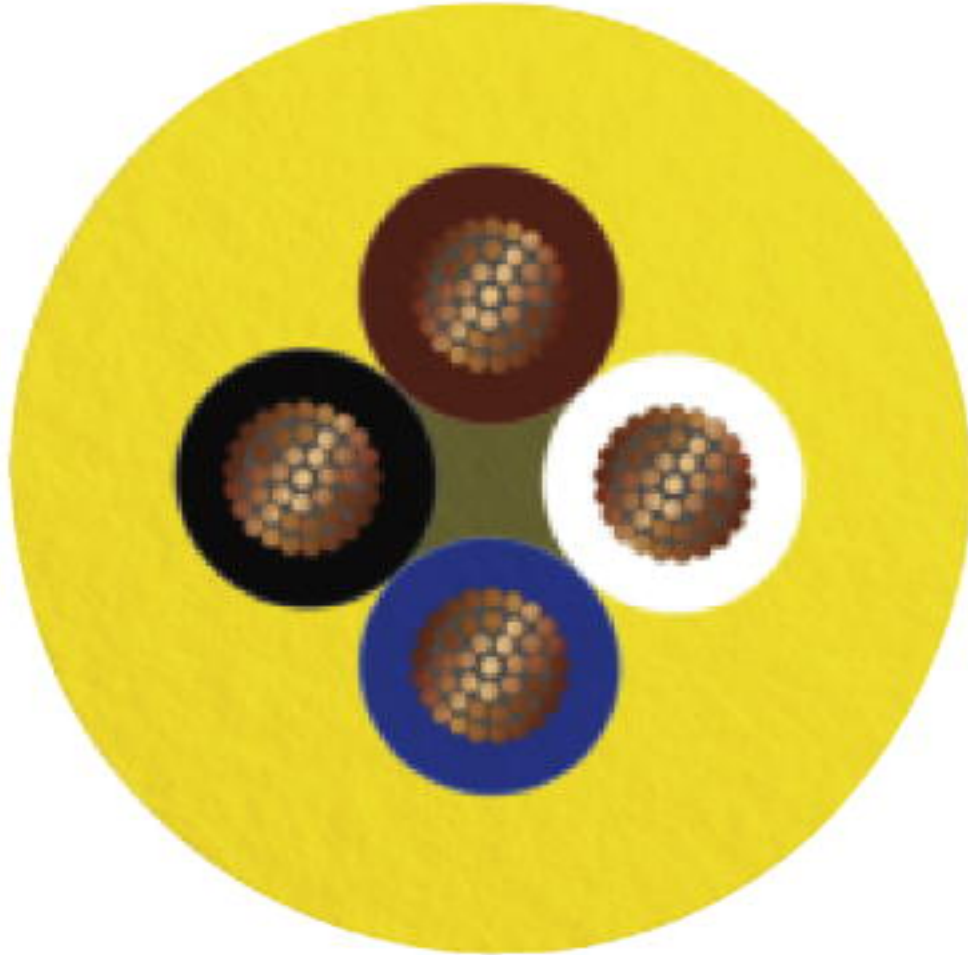

PUR halogen-free yellow [240]

Sensor/actuator cable - SAC-4P-M12MR/.../... - 1696950

Cable cross section

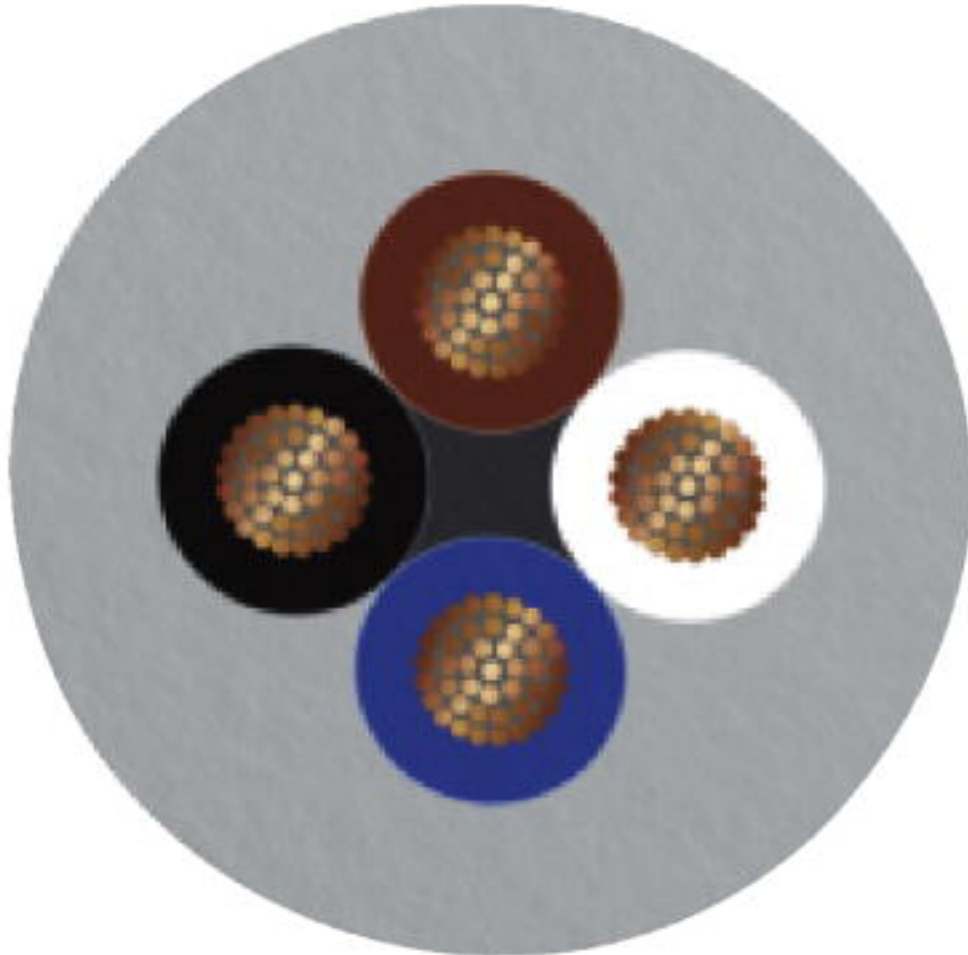

PUR halogen-free gray [280]

Sensor/actuator cable - SAC-4P-M12MR/.../... - 1696950

Cable cross section

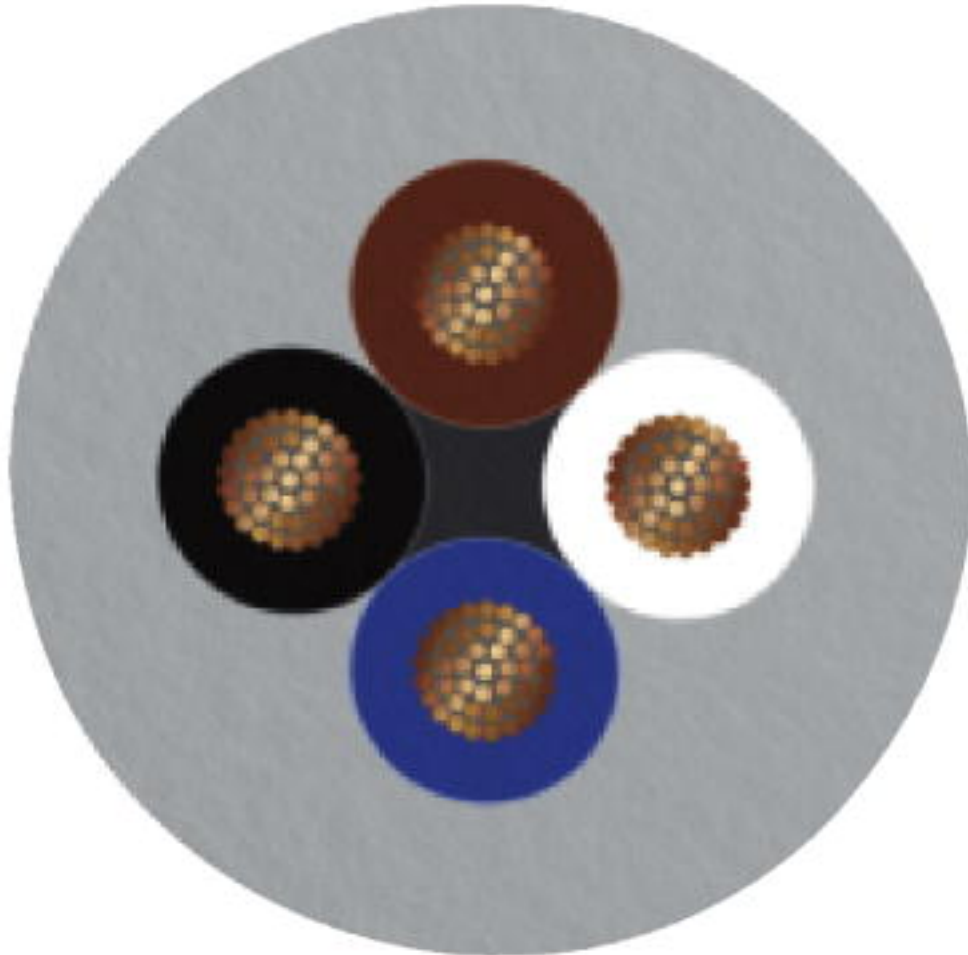

PVC gray [500]

Sensor/actuator cable - SAC-4P-M12MR/.../... - 1696950

Cable cross section

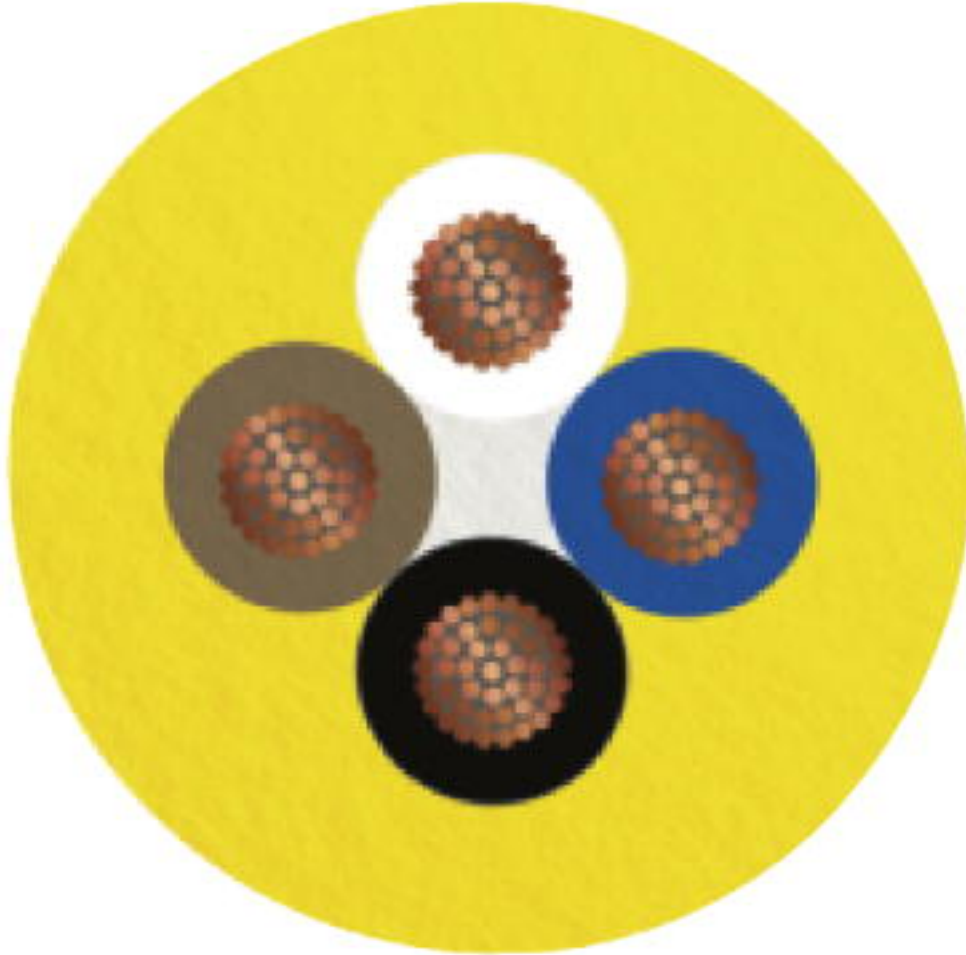

PVC yellow [540]

Sensor/actuator cable - SAC-4P-M12MR/.../... - 1696950

Cable cross section

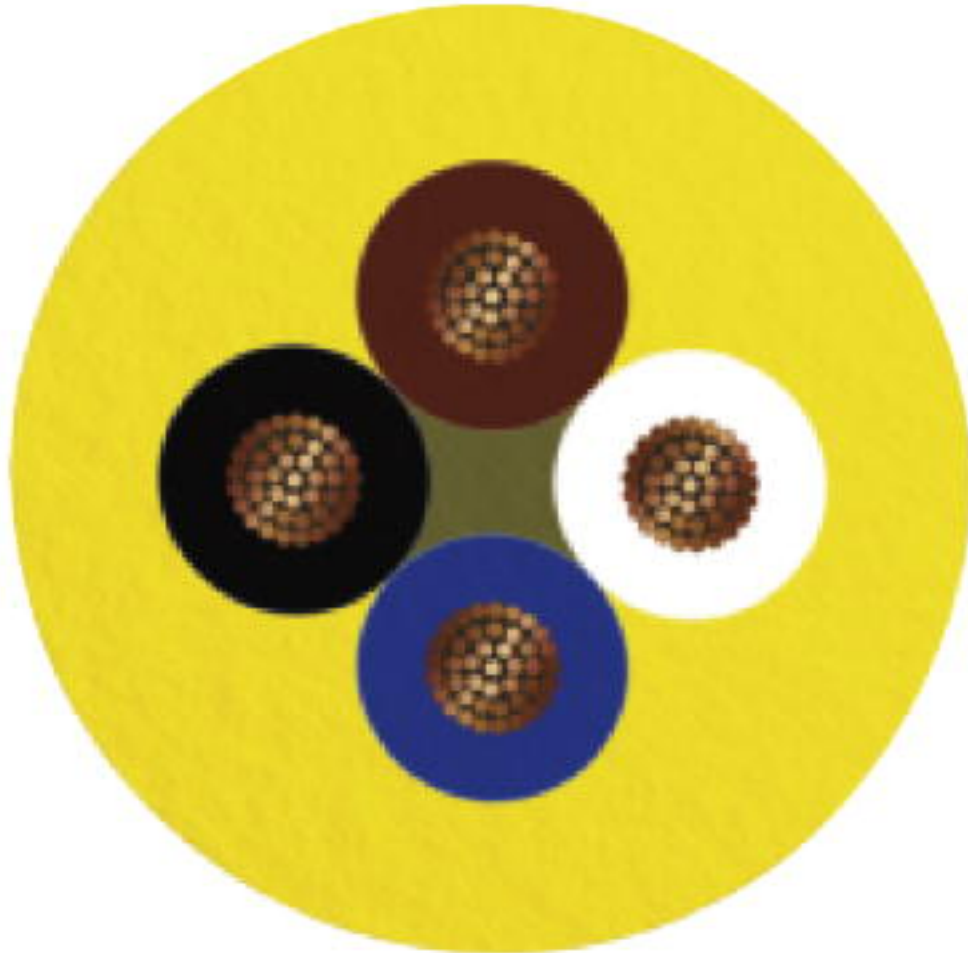

PVC yellow 105 °C [542]

Sensor/actuator cable - SAC-4P-M12MR/.../... - 1696950

Cable cross section

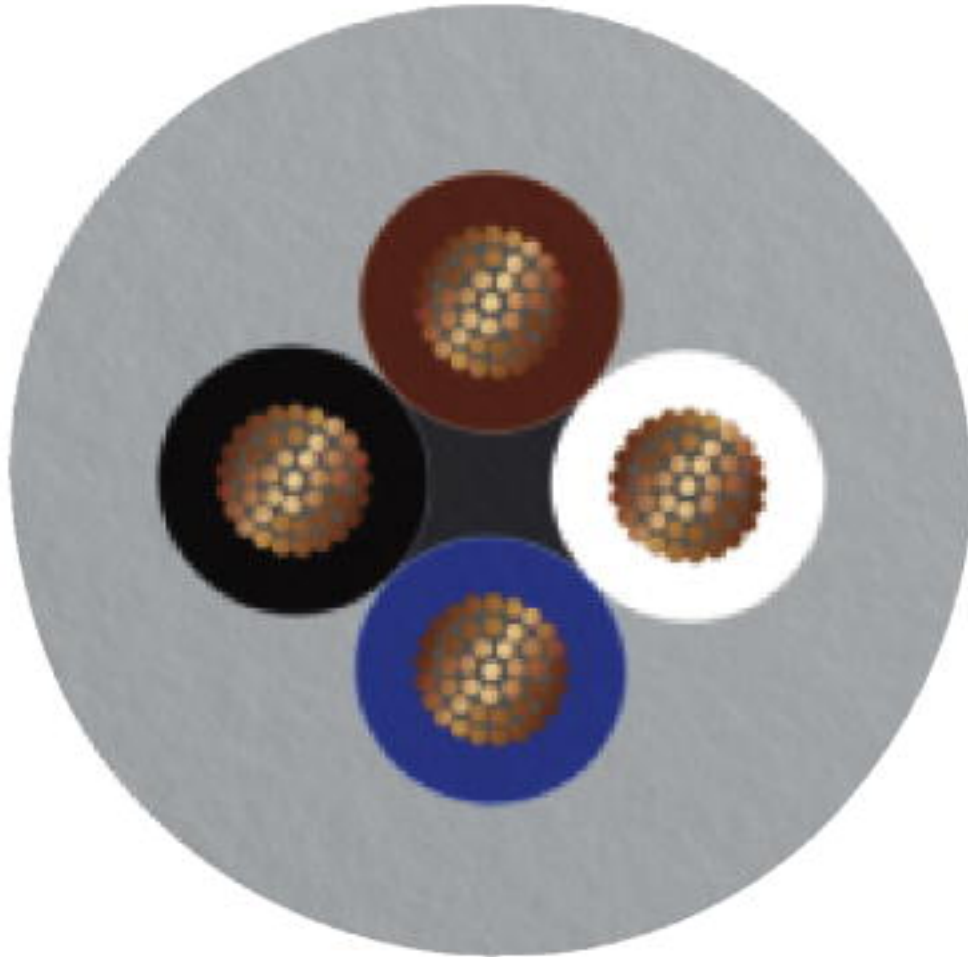

Gray, highly flexible PUR [800]

Sensor/actuator cable - SAC-4P-M12MR/.../... - 1696950

Cable cross section

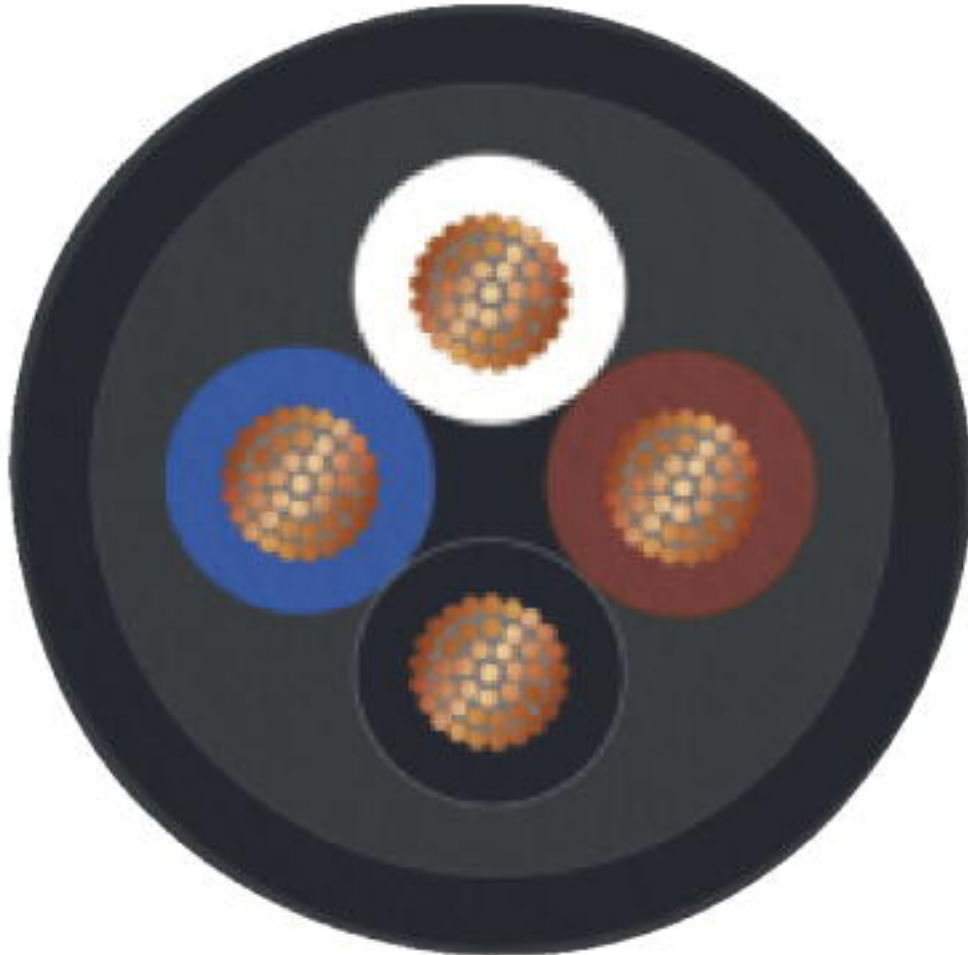

PUR halogen-free black [PUR]

Sensor/actuator cable - SAC-4P-M12MR/.../... - 1696950

Cable cross section

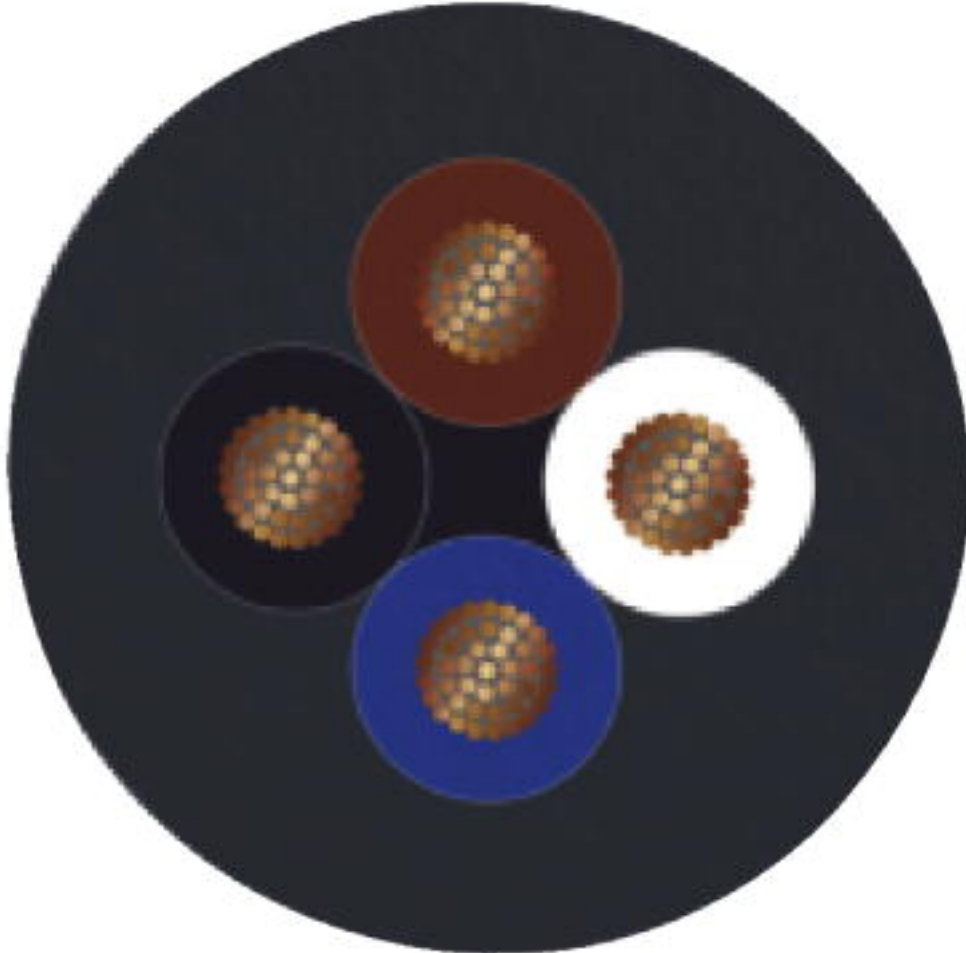

PVC black [PVC]

Classifications

eCl@ss

eCl@ss 10.0.1	27060311
eCl@ss 4.0	27060300
eCl@ss 4.1	27060300
eCl@ss 5.0	27061800
eCl@ss 5.1	27061800
eCl@ss 6.0	27279200
eCl@ss 7.0	27279218
eCl@ss 8.0	27279218
eCl@ss 9.0	27060311

Sensor/actuator cable - SAC-4P-M12MR/.../... - 1696950

Classifications

ETIM

ETIM 2.0	EC000830
ETIM 3.0	EC001855
ETIM 4.0	EC001855
ETIM 5.0	EC001855
ETIM 6.0	EC001855
ETIM 7.0	EC001855

UNSPSC

UNSPSC 6.01	31251501
UNSPSC 7.0901	31251501
UNSPSC 11	31251501
UNSPSC 12.01	31251501
UNSPSC 13.2	31251501
UNSPSC 19.0	31251501
UNSPSC 20.0	31251501
UNSPSC 21.0	31251501

Approvals

Approvals

Approvals

UL Listed / cUL Listed / cULus Listed

Ex Approvals

Approval details

UL Listed		http://database.ul.com/cgi-bin/XYV/template/LISEXT/1FRAME/index.htm	FILE E 221474
Nominal voltage UN	300 V		
Nominal current IN	4 A		

cUL Listed		http://database.ul.com/cgi-bin/XYV/template/LISEXT/1FRAME/index.htm	FILE E 221474
Nominal voltage UN	300 V		

Sensor/actuator cable - SAC-4P-M12MR/.../... - 1696950

Approvals

Nominal current I _N	4 A
--------------------------------	-----

cULus Listed	
--------------	--

Accessories

Accessories

Conductor marking

Insert label - PABA WH/23 - 1013779



Insert label, Strip, white, unlabeled, can be labeled with: CMS-P1-PLOTTER, mounting type: thread on, cable diameter range: 1.5 ... 35 mm, lettering field size: 23 x 4 mm, Number of individual labels: 20

Insert label - PABA YE/23 - 1013782



Insert label, Strip, yellow, unlabeled, can be labeled with: CMS-P1-PLOTTER, mounting type: thread on, cable diameter range: 1.5 ... 35 mm, lettering field size: 23 x 4 mm, Number of individual labels: 20

Corrugated pipe

Protective hose - WP-PA HF 13,0 BK - 3240681



Polyamide protective hose, inflammability class V0, UV resistant

Protective hose - WP-PA HF-HB 13,0 BK - 3240839



Polyamide protective hose, inflammability class HB, UV resistant

Cutting tools

Sensor/actuator cable - SAC-4P-M12MR/.../... - 1696950

Accessories

Diagonal cutter - CUTFOX-S VDE - 1212207



Diagonal cutter for hard (piano wire) and soft wires, VDE 1000 V AC/1500 V DC tested

Marker pen

Marker pen - B-STIFT - 1051993



Marker pen, for manual labeling of unprinted Zack strips, smear-proof and waterproof, line thickness 0.5 mm

Protective cap

Sealing cap - PROT-M12 FS-PA-CHAIN - 1430873



M12 sealing cap made of plastic with fixing band, for sensor cables, for free M12 plugs

Safety locking

Locking clip - SAC-M12-EXCLIP-M - 1558988



Locking clip for the pin side of sensor/actuator cables with M12 connector and M12 connectors for assembly, for knurl diameter: 15 mm or for Allen key with a wrench size of 14 mm, prevents the disconnection of plug-in connections without tools

Screwdriver tools

Adapter insert - TSD-M SAC-BIT ADAPTER - 1212600



Adapter bit for TSD-M...torque tools, E6.3-1/4" drive with 4 mm hexagon to accommodate SAC bits

Sensor/actuator cable - SAC-4P-M12MR/.../... - 1696950

Accessories

Tool - SAC BIT M12-D15 - 1208432



Nut for assembling sensor/actuator cables with M12 connector and M12 connectors for assembly, with a knurl diameter of 15 mm, for 4 mm hexagonal drive

Stripping tool

Stripping tool - WIREFOX SAC-1 - 1212757



Stripping pliers, for halogen-free sensor/actuator cables (SAC cables), with PUR and PVC insulation, from Ø of 3.2 to 4.4 mm, any stripping length

Stripping tool - WIREFOX SAC - 1212623



Stripping pliers, for halogen-free sensor/actuator cables (SAC cables), with PUR and PVC insulation, from Ø of 4.4 to 7 mm, any stripping length

Stripping tool - WIREFOX 10 - 1212150



Stripping tool, for cables and conductors from 0.02 - 10 mm², self-adjusting, stripping length of up to 18 mm, cutting capacity of up to 10 mm² stranded/1.5 mm² solid, replaceable stripping blade

Torque tool

Torque screwdriver - TSD 04 SAC - 1208429



Torque screwdriver, with preset torque of 0.4 Nm and 4 mm hexagonal drive for M12 connectors

Sensor/actuator cable - SAC-4P-M12MR/.../... - 1696950

Accessories

Torque screwdriver - TSD-M 1,2NM - 1212224



Torque screw driver, accuracy as per EN ISO 6789 standard, adjustable from 0.3 - 1.2 Nm

Protective hose adapter - WP-CTA POM 13,0 BK - 1422884



Protective hose adapter, for corrugated hoses with a nominal size of 13 (10 x 13), corrugated in parallel

Phoenix Contact 2020 © - all rights reserved
<http://www.phoenixcontact.com>

PHOENIX CONTACT GmbH & Co. KG
Flachsmarktstr. 8
32825 Blomberg
Germany
Tel. +49 5235 300
Fax +49 5235 3 41200
<http://www.phoenixcontact.com>