

Sensor/actuator cable - SAC-5P-MS-FR-3L SCO/.../... - 1542431

Please be informed that the data shown in this PDF Document is generated from our Online Catalog. Please find the complete data in the user's documentation. Our General Terms of Use for Downloads are valid (<http://phoenixcontact.com/download>)



Sensor/actuator cable, 5-position, Variable cable type, Plug straight M12 SPEEDCON, coding: A, on Socket angled M12 SPEEDCON, coding: A, with 3 LEDs, cable length: Free input (0.2 ... 40.0 m)

Your advantages

- ✓ Easy and safe: 100% electrically tested plug-in components
- ✓ Save time, thanks to installation with SPEEDCON fast locking system
- ✓ Flexible solutions - configurable materials with variable cable types and cable lengths
- ✓ Convenient: increased machine availability thanks to quick and easy diagnostics



Key Commercial Data

Packing unit	1 pc
Minimum order quantity	25 pc

Technical data

Dimensions

Length of cable	Free input (0.2 ... 40.0 m)
-----------------	-----------------------------

Ambient conditions

Ambient temperature (operation)	-25 °C ... 90 °C (Plug / socket)
Degree of protection	IP65
	IP67
	IP68

General

Rated current at 40 °C	4 A
Rated voltage	24 V AC
	24 V DC
Number of positions	5
Insulation resistance	≥ 100 MΩ
Coding	A - standard
Standards/regulations	M12 connector IEC 61076-2-101

Sensor/actuator cable - SAC-5P-MS-FR-3L SCO/.../... - 1542431

Technical data

General

Status display	3 LEDs
Protective circuit/component	unwired
Overvoltage category	II
Degree of pollution	3
Insertion/withdrawal cycles	≥ 100
Torque	0.4 Nm (M12 connector)

Material

Flammability rating according to UL 94	HB
Contact material	CuSn
Contact surface material	Ni/Au
Contact carrier material	TPU GF
Material of grip body	TPU, hardly inflammable, self-extinguishing
Material, knurls	Zinc die-cast, nickel-plated
Sealing material	NBR

Line characteristics

Note	This item is a sensor/actuator cable with a freely selectable cable type. The technical data for all possible cable types is listed in the table below.
------	---

Standards and Regulations

Standards/specifications	M12 connector IEC 61076-2-101
Flammability rating according to UL 94	HB

PUR/PVC gray [100]

Cable type	PUR/PVC gray
Cable type (abbreviation)	100
Cable abbreviation	LiYY-11Y
Conductor cross section	0.34 mm ²
AWG signal line	22
Conductor structure signal line	42x 0.10 mm
Core diameter including insulation	1.5 mm ±0.05 mm
Thickness, insulation	≥ 0.3 mm (Core insulation)
	≥ 0.38 mm (Outer cable sheath)
	approx. 0.35 mm (Inner sheath)
Wire colors	brown, white, blue, black, green-yellow
Overall twist	5 wires around filler to the core
External sheath, color	gray RAL 7001
External cable diameter D	5.9 mm ±0.2 mm
Smallest bending radius, fixed installation	29.5 mm
Smallest bending radius, movable installation	59 mm
Number of bending cycles	2000000
Bending radius	59 mm

Sensor/actuator cable - SAC-5P-MS-FR-3L SCO/.../... - 1542431

Technical data

PUR/PVC gray [100]

Traversing path	5 m
Traversing rate	3 m/s
Cable weight	50 kg/km
Outer sheath, material	PUR
Material, inner sheath	PVC
Material, filler	PVC
Material conductor insulation	PVC
Conductor material	Bare Cu litz wires
Insulation resistance	≥ 100 MΩ*km (at 20 °C)
Conductor resistance	max. 58 Ω/km (at 20 °C)
Nominal voltage, cable	≤ 300 V
Test voltage, cable	≥ 3000 V
Flame resistance	As per UL-Style 2464
Ambient temperature (operation)	-25 °C ... 80 °C (cable, fixed installation)
	-5 °C ... 80 °C (cable, flexible installation)

PUR, black, 5th conductor gray [115]

Cable type	PUR, black, 5th conductor gray
Cable type (abbreviation)	115
Cable abbreviation	Li9Y11Y-HF
UL AWM style	20549 / 10493 (80°C/300 V)
Conductor cross section	5x 0.34 mm ²
AWG signal line	22
Conductor structure signal line	42x 0.10 mm
Core diameter including insulation	1.27 mm ±0.02 mm
Thickness, insulation	≥ 0.21 mm
Wire colors	Brown, white, blue, black, gray
Overall twist	5 cores, twisted
External sheath, color	black-gray RAL 7021
Outer sheath thickness	approx. 0.7 mm
External cable diameter D	5 mm ±0.15 mm
Minimum bending radius, fixed installation	5 x D
Minimum bending radius, flexible installation	10 x D
Number of bending cycles	4000000
Bending radius	50 mm
Traversing path	10 m
Traversing rate	3 m/s
Acceleration	10 m/s ²
Cable weight	35 kg/km
Outer sheath, material	PUR
Material, filler	PP

Sensor/actuator cable - SAC-5P-MS-FR-3L SCO/.../... - 1542431

Technical data

PUR, black, 5th conductor gray [115]

Material conductor insulation	PP
Conductor material	Bare Cu litz wires
Conductor resistance	≤ 58 Ω/km
Nominal voltage, cable	≤ 300 V
Test voltage, cable	≥ 3000 V
Special properties	Flexible cable conduit capable
	Silicone-free
	Free of substances which would hinder coating with paint or varnish
	flexible
Flame resistance	in accordance with DIN UL-Style 20549
	in accordance with UL 758/1581 FT2
Halogen-free	in accordance with DIN VDE 0472 part 815
Resistance to oil	in accordance with DIN EN 60811-2-1
Other resistance	partly UV-resistant in accordance with DIN EN ISO 4892-2-A
	hydrolysis and microbe resistant
	Resistant to salt water
	Low adhesion
	abrasion-resistant
Ambient temperature (operation)	-40 °C ... 80 °C (cable, fixed installation)
	-25 °C ... 80 °C (cable, flexible installation)

PUR halogen-free yellow [240]

Cable type	PUR halogen-free yellow
Cable type (abbreviation)	240
Cable abbreviation	Li9Y11Y
UL AWM style	20549 / 10493 (80°C/300 V)
Conductor cross section	5x 0.34 mm ²
AWG signal line	22
Conductor structure signal line	42x 0.10 mm
Core diameter including insulation	1.27 mm ±0.02 mm
Thickness, insulation	≥ 0.21 mm
Wire colors	brown, white, blue, black, green-yellow
Overall twist	5 wires around filler to the core
Length of twist, overall twist	55 mm
External sheath, color	yellow
Outer sheath thickness	approx. 0.7 mm
External cable diameter D	5 mm ±0.15 mm
Minimum bending radius, fixed installation	5 x D
Minimum bending radius, flexible installation	10 x D
Number of bending cycles	4000000
Minimum bending radius, drag chain applications	10 x D

Sensor/actuator cable - SAC-5P-MS-FR-3L SCO/.../... - 1542431

Technical data

PUR halogen-free yellow [240]

Traversing path	10 m
Traversing rate	3 m/s
Acceleration	10 m/s ²
Cable weight	35 kg/km
Outer sheath, material	PUR
Material conductor insulation	PP
Conductor material	Bare Cu litz wires
Conductor resistance	≤ 58 Ω/km (at 20 °C)
Nominal voltage, cable	≤ 300 V
Test voltage, cable	≥ 3000 V
Flame resistance	in accordance with DIN UL-Style 20549
	in accordance with UL 758/1581 FT2
Halogen-free	in accordance with DIN VDE 0472 part 815
Resistance to oil	in accordance with DIN EN 60811-2-1
Other resistance	hydrolysis and microbe resistant
	Resistant to salt water
Ambient temperature (operation)	-40 °C ... 80 °C (cable, fixed installation)
	-25 °C ... 80 °C (cable, flexible installation)

PUR irradiated halogen-free orange [150]

Cable type	PUR irradiated halogen-free orange
Cable type (abbreviation)	150
Cable abbreviation	D12YSL11X-JB
Conductor cross section	4x 0.34 mm ² (Signal line)
	1x 0.5 mm ² (PE connection)
AWG signal line	22
AWG power supply	20
Conductor structure signal line	42x 0.10 mm
Conductor structure, voltage supply	24x 0.15 mm
Wire colors	Brown, blue, black, white, green/yellow
Overall twist	5 cores, twisted
External sheath, color	orange RAL 2003
External cable diameter D	5.2 mm ±0.2 mm
Smallest bending radius, fixed installation	min. 20 mm
Smallest bending radius, movable installation	min. 30 mm
Number of bending cycles	5000000
Bending radius	52 mm
Traversing path	10 m
Traversing rate	3 m/s
Outer sheath, material	PUR
Material conductor insulation	PE

Sensor/actuator cable - SAC-5P-MS-FR-3L SCO/.../... - 1542431

Technical data

PUR irradiated halogen-free orange [150]

Conductor material	Bare Cu litz wires
Conductor resistance	≤ 57.5 Ω/km (with 0.34 mm ² conductor cross section)
	≤ 39 Ω/km (with 0.5 mm ² conductor cross section)
Nominal voltage, cable	250 V (AC)
Test voltage, cable	2000 V (50 Hz, 5 minutes)
Special properties	Silicone-free
	Irradiated
Flame resistance	DIN VDE 0472 part 804, test type B
Halogen-free	The cable is halogen-free
Other resistance	hydrolysis and microbe resistant
	UV resistant
	Resistant to welding splashes
Ambient temperature (operation)	-50 °C ... 105 °C (cable, fixed installation)
	-40 °C ... 105 °C (cable, flexible installation)

PUR halogen-free orange [180]

Cable type	PUR halogen-free orange
Cable type (abbreviation)	180
Cable abbreviation	Li9YLi9Y-11Y
UL AWM style	20549
Conductor cross section	4x 0.34 mm ² (Signal line)
	1x 0.5 mm ² (PE connection)
AWG signal line	22
AWG power supply	20
Conductor structure signal line	42x 0.10 mm
Conductor structure, voltage supply	28x 0.15 mm
Core diameter including insulation	1.27 mm ±0.02 mm (Signal line)
	1.46 mm ±0.02 mm (PE connection)
Thickness, insulation	≥ 0.21 mm (Signal line)
	≥ 0.21 mm (PE connection)
	approx. 0.65 mm (Outer cable sheath)
Wire colors	brown, white, blue, black, green-yellow
Overall twist	5 wires around filler to the core
External sheath, color	orange RAL 2003
External cable diameter D	5 mm ±0.15 mm
Cable weight	36 kg/km
Outer sheath, material	PUR
Material conductor insulation	PP
Conductor material	Bare Cu litz wires
Insulation resistance	≥ 10 GΩ*km (at 20 °C)
Conductor resistance	≤ 58 Ω/km (Signal line)

Sensor/actuator cable - SAC-5P-MS-FR-3L SCO/.../... - 1542431

Technical data

PUR halogen-free orange [180]

	≤ 39 Ω/km (PE connection)
Nominal voltage, cable	≤ 300 V
Test voltage, cable	≥ 3000 V
Flame resistance	in accordance with DIN UL-Style 20549
Halogen-free	in accordance with DIN VDE 0472 part 815
Ambient temperature (operation)	-25 °C ... 80 °C (Cable)

PUR halogen-free gray [280]

Cable type	PUR halogen-free gray
Cable type (abbreviation)	280
Conductor cross section	0.34 mm ²
AWG signal line	22
AWG power supply	20
Conductor structure signal line	42x 0.10 mm
Conductor structure, voltage supply	28x 0.15 mm
Core diameter including insulation	1.55 mm (Signal line)
	1.65 mm (Protective conductor)
Thickness, insulation	0.39 mm (Signal line)
	0.37 mm (Protective conductor)
	0.65 mm (Outer cable sheath)
Wire colors	brown, white, blue, black, green-yellow
Overall twist	5 wires around filler to the core
External sheath, color	gray RAL 7001
External cable diameter	5.20 mm
Outer sheath, material	PUR
Material, filler	Fiberglass
Material conductor insulation	TPE
Conductor material	Bare Cu litz wires
Ambient temperature (operation)	-40 °C ... 80 °C (cable, fixed installation)
	-5 °C ... 80 °C (cable, flexible installation)

PVC gray [500]

Cable type	PVC gray
Cable type (abbreviation)	500
Cable abbreviation	LiYY
Conductor cross section	0.34 mm ²
AWG signal line	22
Conductor structure signal line	42x 0.10 mm
Core diameter including insulation	1.45 mm ±0.02 mm
Thickness, insulation	≥ 0.23 mm (Core insulation)
	≥ 0.76 mm (Outer cable sheath)
Wire colors	brown, white, blue, black, green-yellow

Sensor/actuator cable - SAC-5P-MS-FR-3L SCO/.../... - 1542431

Technical data

PVC gray [500]

Overall twist	5 wires around filler to the core
External sheath, color	gray RAL 7001
External cable diameter D	5.9 mm ±0.15 mm
Cable weight	51 kg/km
Outer sheath, material	PVC
Material, filler	PVC
Material conductor insulation	PVC
Conductor material	Bare Cu litz wires
Insulation resistance	≥ 1 GΩ*km (at 20 °C)
Conductor resistance	max. 58 Ω/km (at 20 °C)
Nominal voltage, cable	≤ 300 V (AC)
Test voltage, cable	≥ 3000 V (AC)
Flame resistance	As per UL-Style 2464
	according to UL 758/1581 FT1
Resistance to oil	in accordance with DIN EN 60811-2-1
Ambient temperature (operation)	-40 °C ... 80 °C (cable, fixed installation)
	-25 °C ... 80 °C (cable, flexible installation)

PVC black 5th conductor gray [515]

Cable abbreviation	LiYY
UL AWM style	2464 / 1729 (80°C/300 V)
Conductor cross section	5x 0.34 mm ² (Signal line)
AWG signal line	22
Conductor structure signal line	42x 0.10 mm
Core diameter including insulation	1.45 mm ±0.02 mm
Thickness, insulation	≥ 0.23 mm (Core insulation)
	≥ 0.76 mm (Outer cable sheath)
Wire colors	Brown, white, blue, black, gray
Overall twist	5 wires around filler to the core
Length of twist, overall twist	60 mm
External sheath, color	black RAL 9005
External cable diameter D	5.9 mm ±0.15 mm
Minimum bending radius, fixed installation	5 x D
Minimum bending radius, flexible installation	10 x D
Cable weight	52 kg/km
Outer sheath, material	PVC
Material, filler	PP yarn
Material conductor insulation	PVC
Conductor material	Bare Cu litz wires
Insulation resistance	≥ 100 MΩ*km (at 20 °C)
Conductor resistance	≤ 58 Ω/km (at 20 °C)

Sensor/actuator cable - SAC-5P-MS-FR-3L SCO/.../... - 1542431

Technical data

PVC black 5th conductor gray [515]

Nominal voltage, cable	≤ 300 V AC
Test voltage, cable	≥ 3000 V AC
Flame resistance	According to UL 758/1581 (Cable Flame)
	according to UL 758/1581 FT1
	According to DIN EN 60332-1-2 (60 s)
Resistance to oil	according to DIN EN 60811-2-1, 168 h at 60 °C
Ambient temperature (operation)	-40 °C ... 80 °C (cable, fixed installation)
	-25 °C ... 80 °C (cable, flexible installation)

PVC gray 5th conductor gray [520]

Cable abbreviation	LiYY
Conductor cross section	0.34 mm ²
AWG signal line	22
Conductor structure signal line	42x 0.10 mm
Core diameter including insulation	1.45 mm ±0.02 mm
Thickness, insulation	≥ 0.23 mm (Core insulation)
	≥ 0.76 mm (Outer cable sheath)
Wire colors	Brown, white, blue, black, gray
Overall twist	5 wires around filler to the core
Length of twist, overall twist	55 mm
External sheath, color	gray RAL 7001
External cable diameter D	5.9 mm ±0.15 mm
Cable weight	54 kg/km
Outer sheath, material	PVC
Material, filler	PVC
Material conductor insulation	PVC
Conductor material	Bare Cu litz wires
Insulation resistance	≥ 1 GΩ*km (at 20 °C)
Conductor resistance	max. 58 Ω/km (at 20 °C)
Nominal voltage, cable	≤ 300 V
Test voltage, cable	≥ 3000 V
Flame resistance	As per UL-Style 2464
Ambient temperature (operation)	-25 °C ... 80 °C (cable, fixed installation)
	-5 °C ... 80 °C (cable, flexible installation)

PVC yellow [540]

Cable type	PVC yellow
Cable type (abbreviation)	540
Cable abbreviation	LiFY
Conductor cross section	0.34 mm ²
AWG signal line	22
Conductor structure signal line	43x 0.10 mm

Sensor/actuator cable - SAC-5P-MS-FR-3L SCO/.../... - 1542431

Technical data

PVC yellow [540]

Core diameter including insulation	1.45 mm ±0.02 mm
Thickness, insulation	approx. 0.23 mm (Core insulation)
	approx. 0.76 mm (Outer cable sheath)
Wire colors	brown, white, blue, black, green-yellow
Overall twist	5 wires around filler to the core
Length of twist, overall twist	70 mm
External sheath, color	yellow
External cable diameter D	5.9 mm ±0.15 mm
Smallest bending radius, fixed installation	29.5 mm
Smallest bending radius, movable installation	59 mm
Outer sheath, material	PVC
Material, filler	PVC
Material conductor insulation	PVC
Conductor material	Bare Cu litz wires
Insulation resistance	≥ 1 MΩ*km (at 20 °C)
Conductor resistance	max. 58 Ω/km (at 20 °C)
Nominal voltage, cable	≤ 300 V (AC)
Test voltage, cable	3000 V
Flame resistance	As per UL-Style 2464
	according to UL 758/1581 FT1
Resistance to oil	in accordance with DIN EN 60811-2-1
Ambient temperature (operation)	-40 °C ... 80 °C (cable, fixed installation)
	-25 °C ... 80 °C (cable, flexible installation)

PVC yellow 105 °C [542]

Cable type	PVC yellow 105 °C
Cable type (abbreviation)	542
Conductor cross section	0.34 mm ²
AWG signal line	22
Conductor structure signal line	42x 0.10 mm
Core diameter including insulation	1.55 mm ±0.05 mm
Thickness, insulation	≥ 0.38 mm (Core insulation)
	≥ 0.76 mm (Outer cable sheath)
Wire colors	Brown, white, blue, black, gray
Overall twist	5 wires around filler to the core
External sheath, color	yellow
External cable diameter D	5.9 mm ±0.2 mm
Cable weight	50 kg/km
Outer sheath, material	PVC
Material conductor insulation	PVC
Conductor material	Bare Cu litz wires

Sensor/actuator cable - SAC-5P-MS-FR-3L SCO/.../... - 1542431

Technical data

PVC yellow 105 °C [542]

Insulation resistance	≥ 100 MΩ*km (at 20 °C)
Conductor resistance	max. 58 Ω/km (at 20 °C)
Nominal voltage, cable	≤ 300 V
Test voltage, cable	≥ 3000 V
Flame resistance	in accordance with UL-Style 2517

Gray, highly flexible PUR [800]

Note	Due to the extremely robust outer sheath, this cable should only be stripped in 5 cm increments.
Cable type	Gray, highly flexible PUR
Cable type (abbreviation)	800
Cable abbreviation	LiF9Y11Y
UL AWM style	20549
Conductor cross section	5x 0.34 mm ² (Signal line)
AWG signal line	22
Conductor structure signal line	42x 0.10 mm
Core diameter including insulation	1.3 mm ±0.05 mm (Signal line)
Wire colors	Black, brown, blue, white, gray
Overall twist	5 wires around filler to the core
External sheath, color	gray RAL 7001
External cable diameter D	5.1 mm ±0.2 mm
Minimum bending radius, fixed installation	4 x D
Minimum bending radius, flexible installation	7.5 x D
Number of bending cycles	10000000
Minimum bending radius, drag chain applications	7,5 x D
Traversing path	5 m
Traversing rate	3.3 m/s
Acceleration	5 m/s ²
Number of bending cycles	15000000
Bending radius	50 mm
Traversing path	0.9 m
Traversing rate	5 m/s
Acceleration	30 m/s ²
Torsion force	± 360 °/m (1 000 000 torsion cycles)
Cable weight	38 kg/km
Outer sheath, material	PUR
Material, filler	PE
Material conductor insulation	PP
Conductor material	Bare Cu litz wires
Insulation resistance	≥ 20 MΩ*km
Conductor resistance	approx. 53 Ω/km

Sensor/actuator cable - SAC-5P-MS-FR-3L SCO/.../... - 1542431

Technical data

Gray, highly flexible PUR [800]

Nominal voltage, cable	300 V
Test voltage, cable	2000 V
Special properties	Cable jacket is welding spark-resistant, recyclable, matt, low-adhesion, abrasion-resistant, flame-retardant, and self-extinguishing
	Free from silicone and cadmium
	Free of substances which would hinder coating with paint or varnish
Flame resistance	in accordance with UL 758/1581 FT2
Halogen-free	in accordance with DIN VDE 0472 part 815
Resistance to oil	in accordance with DIN EN 60811-2-1
Other resistance	Highly resistant to acids, alkaline solutions and solvents
	Silicone-free
Ambient temperature (operation)	-40 °C ... 80 °C (cable, fixed installation)
	-25 °C ... 80 °C (cable, flexible installation)

PUR halogen-free black [PUR]

Cable type	PUR halogen-free black
Cable type (abbreviation)	PUR
UL AWM style	20549
Conductor cross section	5x 0.34 mm ² (Signal line)
AWG signal line	22
Conductor structure signal line	42x 0.10 mm
Core diameter including insulation	1.27 mm ±0.02 mm (Signal line)
Thickness, insulation	approx. 0.5 mm
Wire colors	brown, white, blue, black, green-yellow
External sheath, color	black-gray RAL 7021
External cable diameter D	4.55 mm ±0.15 mm
Smallest bending radius, fixed installation	23 mm
Smallest bending radius, movable installation	46 mm
Number of bending cycles	10000000
Bending radius	50 mm
Traversing path	10 m
Traversing rate	3 m/s
Acceleration	10 m/s ²
Cable weight	33 kg/km
Outer sheath, material	PUR
Material conductor insulation	PP
Conductor material	Bare Cu litz wires
Insulation resistance	≥ 16 GΩ*km (at 20 °C)
Conductor resistance	max. 58 Ω/km (at 20 °C)
Nominal voltage, cable	300 V
Test voltage, cable	3000 V

Sensor/actuator cable - SAC-5P-MS-FR-3L SCO/.../... - 1542431

Technical data

PUR halogen-free black [PUR]

Special properties	Flexible cable conduit capable
	Silicone-free
	Free of substances which would hinder coating with paint or varnish
	flexible
Flame resistance	in accordance with UL 758/1581 FT2
	DIN EN 60332-2-2 (20 s)
Halogen-free	in accordance with DIN VDE 0472 part 815
Resistance to oil	in accordance with DIN EN 60811-2-1
Other resistance	Highly resistant to acids, alkaline solutions and solvents
	hydrolysis and microbe resistant
	Resistant to salt water
	partly UV-resistant in accordance with DIN EN ISO 4892-2-A
Ambient temperature (operation)	-40 °C ... 80 °C (cable, fixed installation)
	-25 °C ... 80 °C (cable, flexible installation)

PVC black [PVC]

Cable type	PVC black
Cable type (abbreviation)	PVC
Cable abbreviation	LiYY
UL AWM style	2464 / 1729 (80°C/300 V)
Conductor cross section	5x 0.34 mm ² (Signal line)
AWG signal line	22
Conductor structure signal line	42x 0.10 mm
Core diameter including insulation	1.45 mm ±0.02 mm
Thickness, insulation	≥ 0.23 mm (Core insulation)
Wire colors	brown, white, blue, black, green-yellow
Overall twist	5 wires around filler to the core
External sheath, color	black RAL 9005
Outer sheath thickness	≥ 0.76 mm
External cable diameter D	5.9 mm ±0.15 mm
Minimum bending radius, fixed installation	5 x D
Minimum bending radius, flexible installation	10 x D
Cable weight	51 kg/km
Outer sheath, material	PVC
Material conductor insulation	PVC
Conductor material	Bare Cu litz wires
Insulation resistance	≥ 200 MΩ*km (at 20 °C)
Conductor resistance	max. 58 Ω/km (at 20 °C)
Nominal voltage, cable	≤ 300 V
Test voltage, cable	≥ 3000 V
Flame resistance	As per UL-Style 2464

Sensor/actuator cable - SAC-5P-MS-FR-3L SCO/.../... - 1542431

Technical data

PVC black [PVC]

	according to UL 758/1581 FT1
Resistance to oil	According to DIN EN 60811-2-1, 168 h at 90°C
Ambient temperature (operation)	-40 °C ... 80 °C (cable, fixed installation)
	-25 °C ... 80 °C (cable, flexible installation)

Environmental Product Compliance

China RoHS	Environmentally friendly use period: unlimited = EFUP-e
	No hazardous substances above threshold values

Drawings

Dimensional drawing

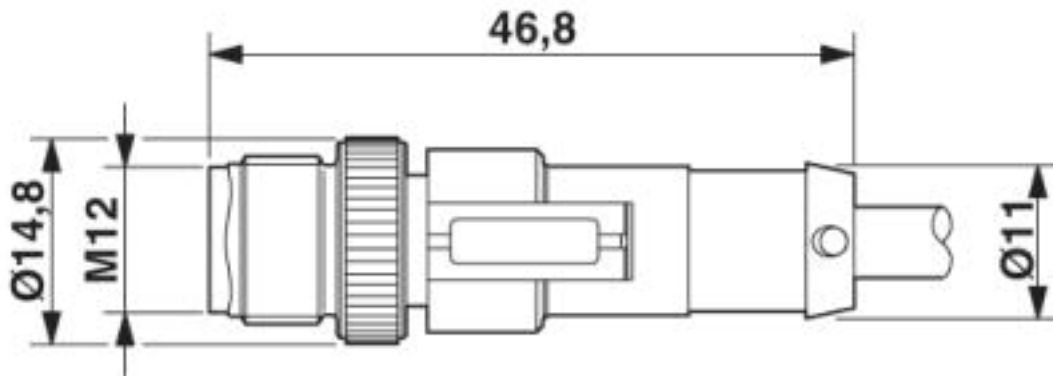

Plug, M12 x 1, straight, shielded

Sensor/actuator cable - SAC-5P-MS-FR-3L SCO/.../... - 1542431

Dimensional drawing

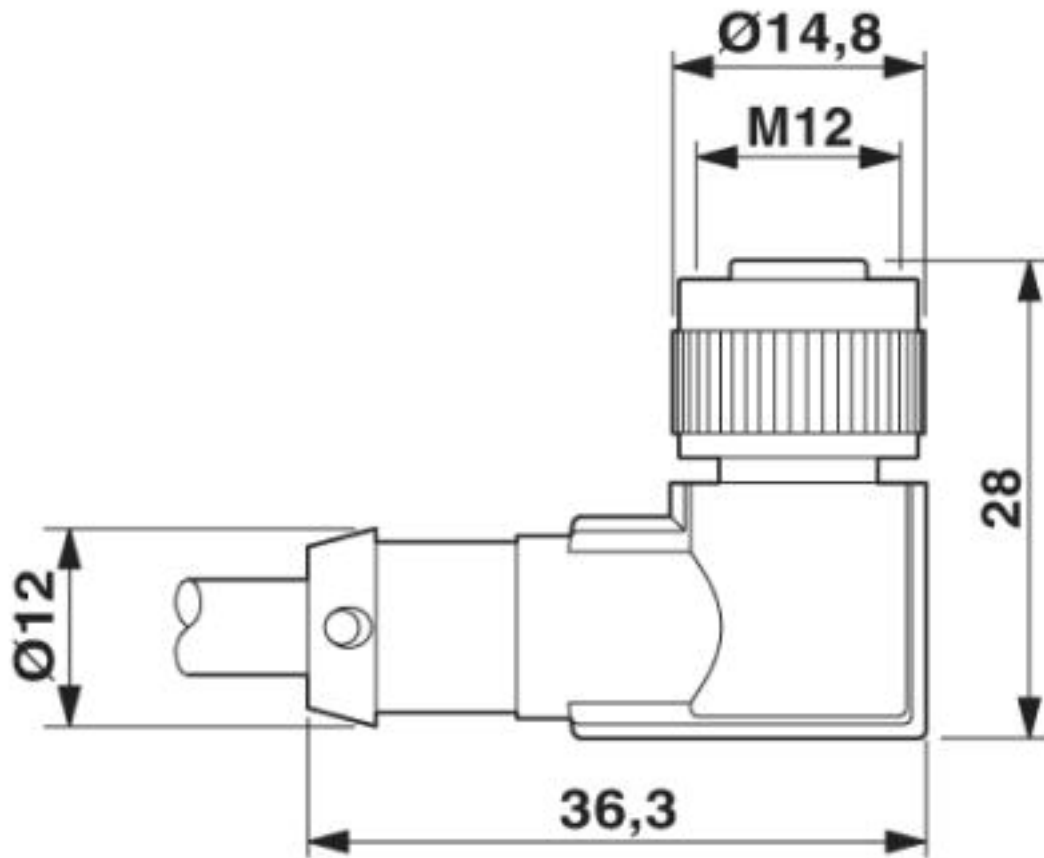

M12 x 1 socket, angled

Sensor/actuator cable - SAC-5P-MS-FR-3L SCO/.../... - 1542431

Circuit diagram

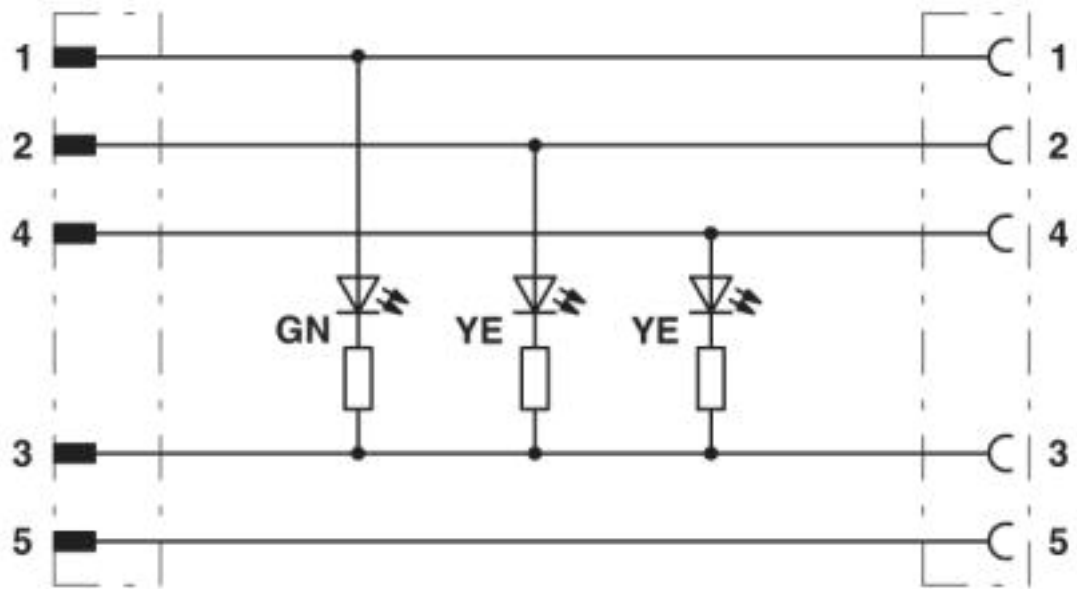

Contact assignment of the M12 plug and the M12 socket

Sensor/actuator cable - SAC-5P-MS-FR-3L SCO/.../... - 1542431

Schematic diagram

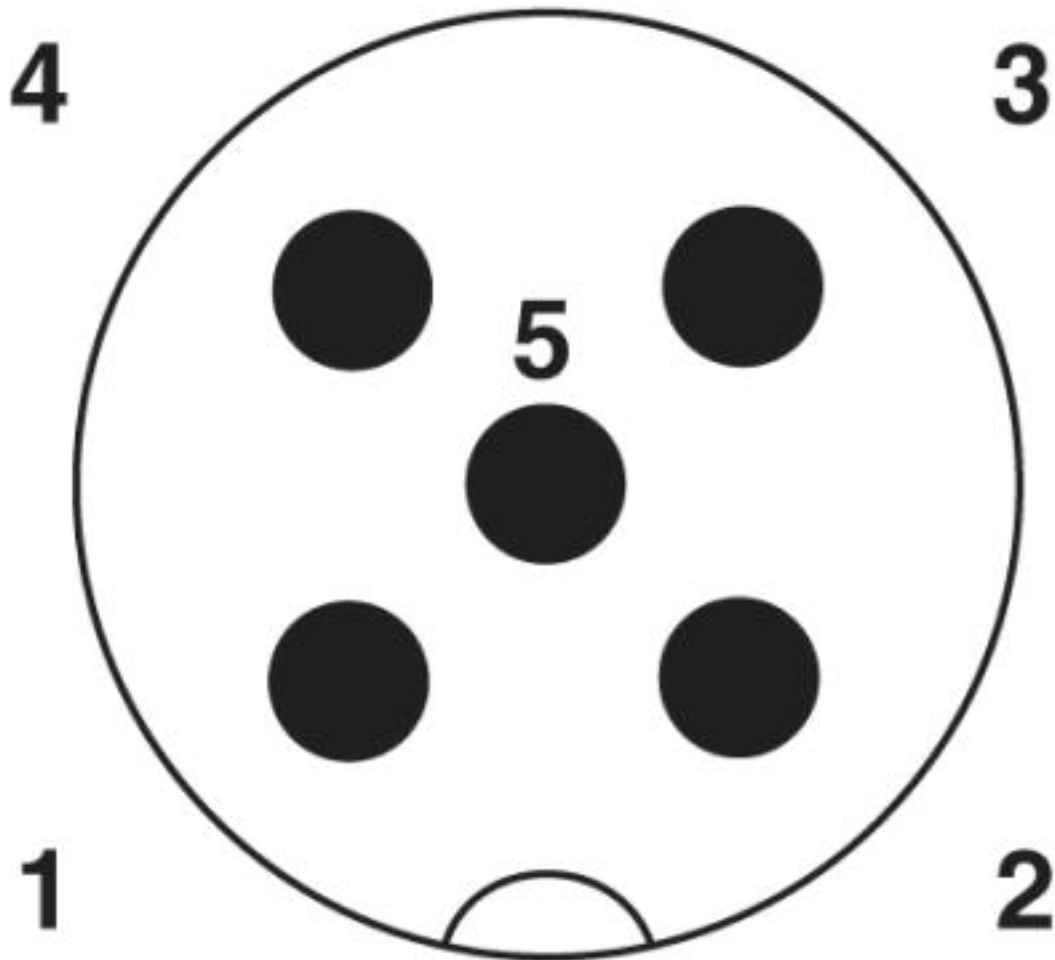

Pin assignment M12 male connector, 5-pos., A-coded, male side

Sensor/actuator cable - SAC-5P-MS-FR-3L SCO/.../... - 1542431

Schematic diagram

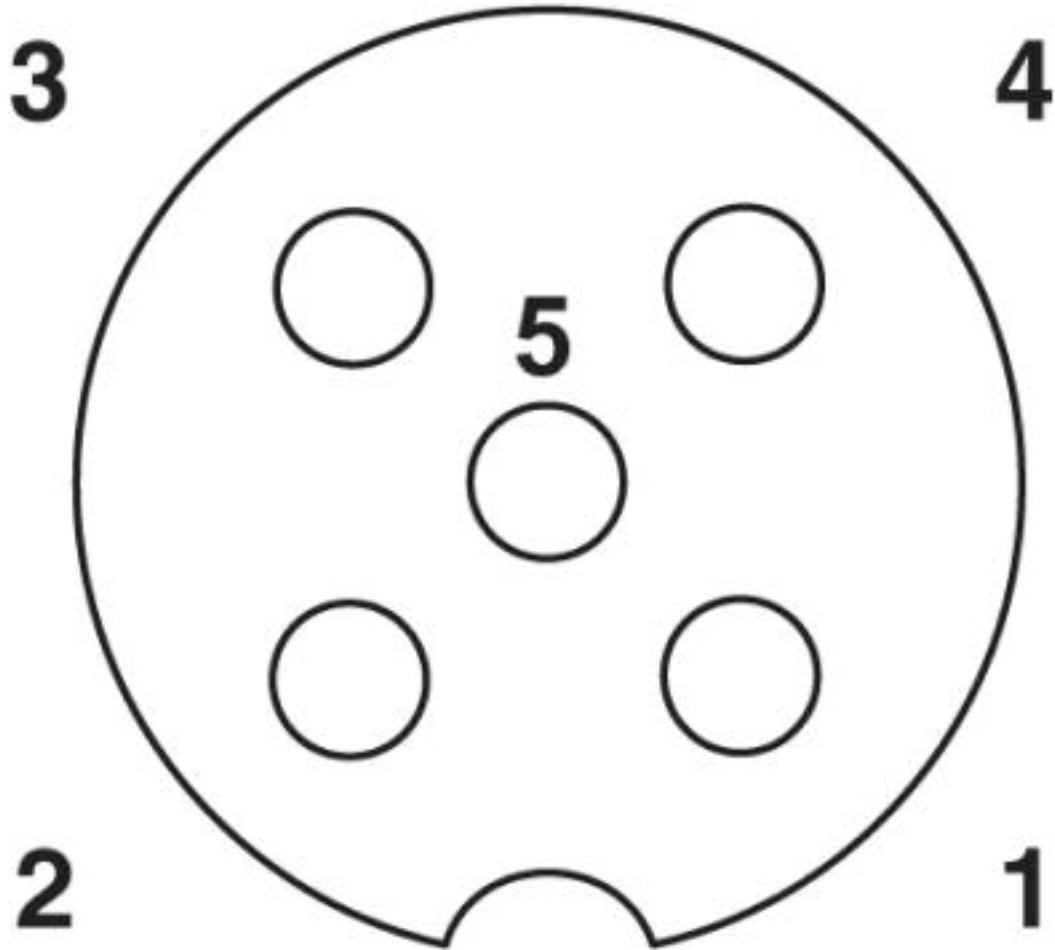

Pin assignment M12 socket, 5-pos., A-coded, socket side view

Sensor/actuator cable - SAC-5P-MS-FR-3L SCO/.../... - 1542431

Cable cross section

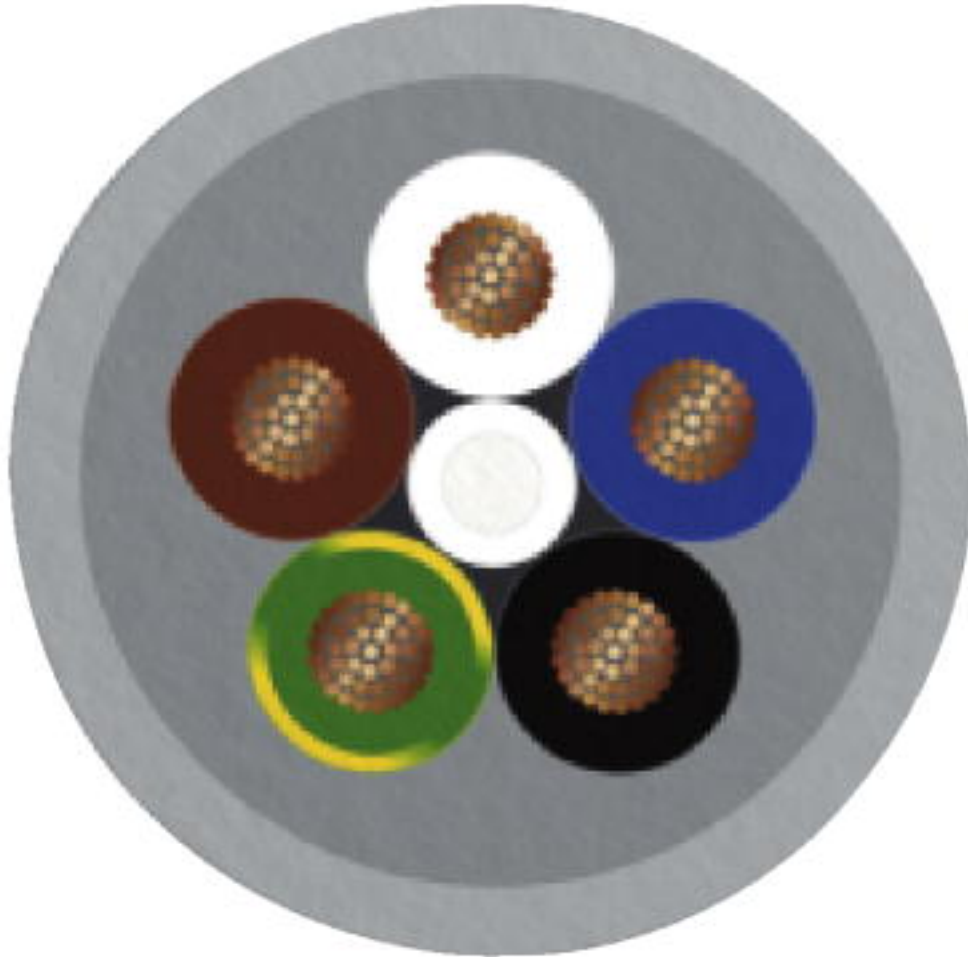

PUR/PVC gray [100]

Sensor/actuator cable - SAC-5P-MS-FR-3L SCO/.../... - 1542431

Cable cross section

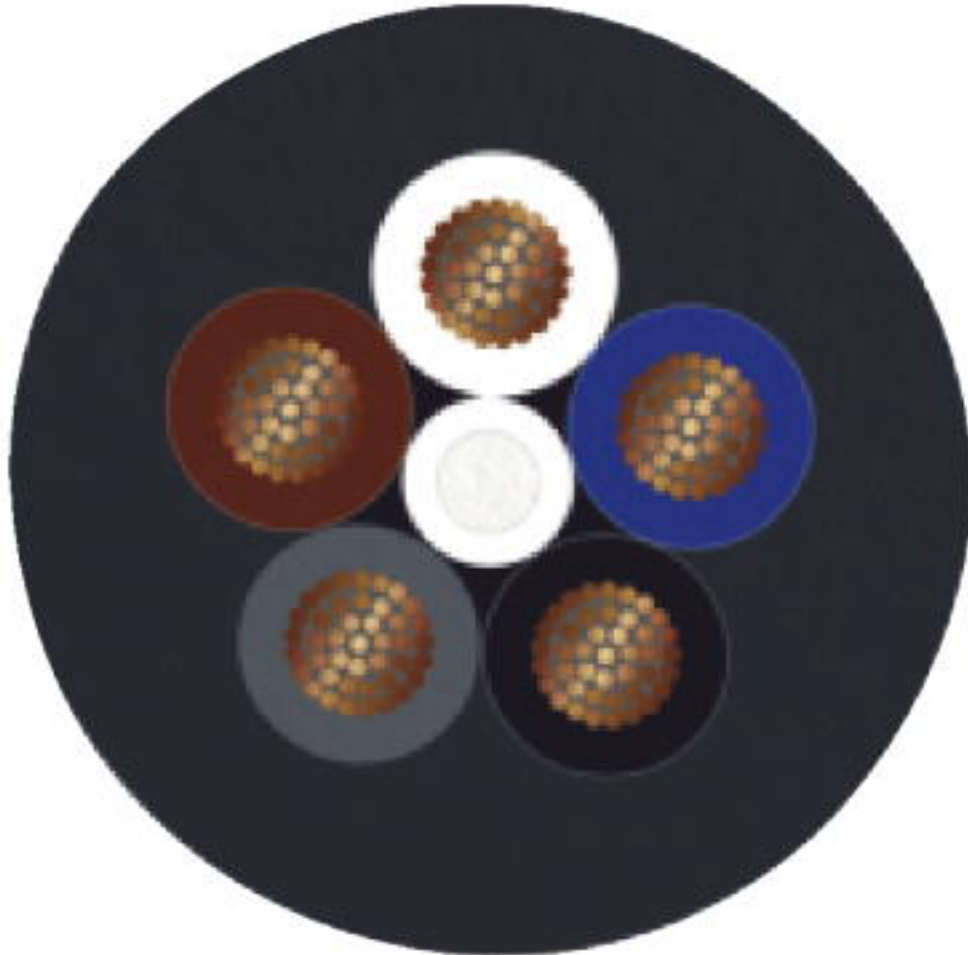

PUR, black, 5th conductor gray [115]

Sensor/actuator cable - SAC-5P-MS-FR-3L SCO/.../... - 1542431

Cable cross section

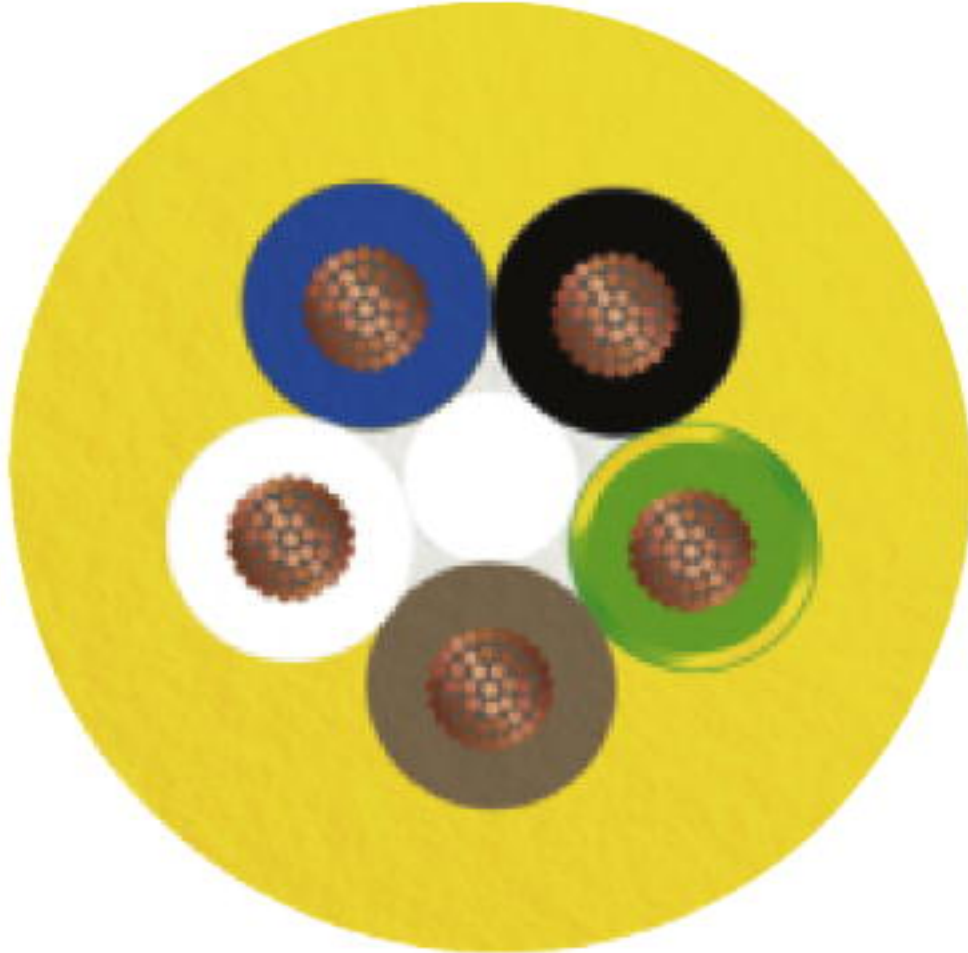

PUR halogen-free yellow [240]

Sensor/actuator cable - SAC-5P-MS-FR-3L SCO/.../... - 1542431

Cable cross section



PUR irradiated halogen-free orange [150]

Sensor/actuator cable - SAC-5P-MS-FR-3L SCO/.../... - 1542431

Cable cross section



PUR halogen-free orange [180]

Sensor/actuator cable - SAC-5P-MS-FR-3L SCO/.../... - 1542431

Cable cross section



PUR halogen-free gray [280]

Sensor/actuator cable - SAC-5P-MS-FR-3L SCO/.../... - 1542431

Cable cross section

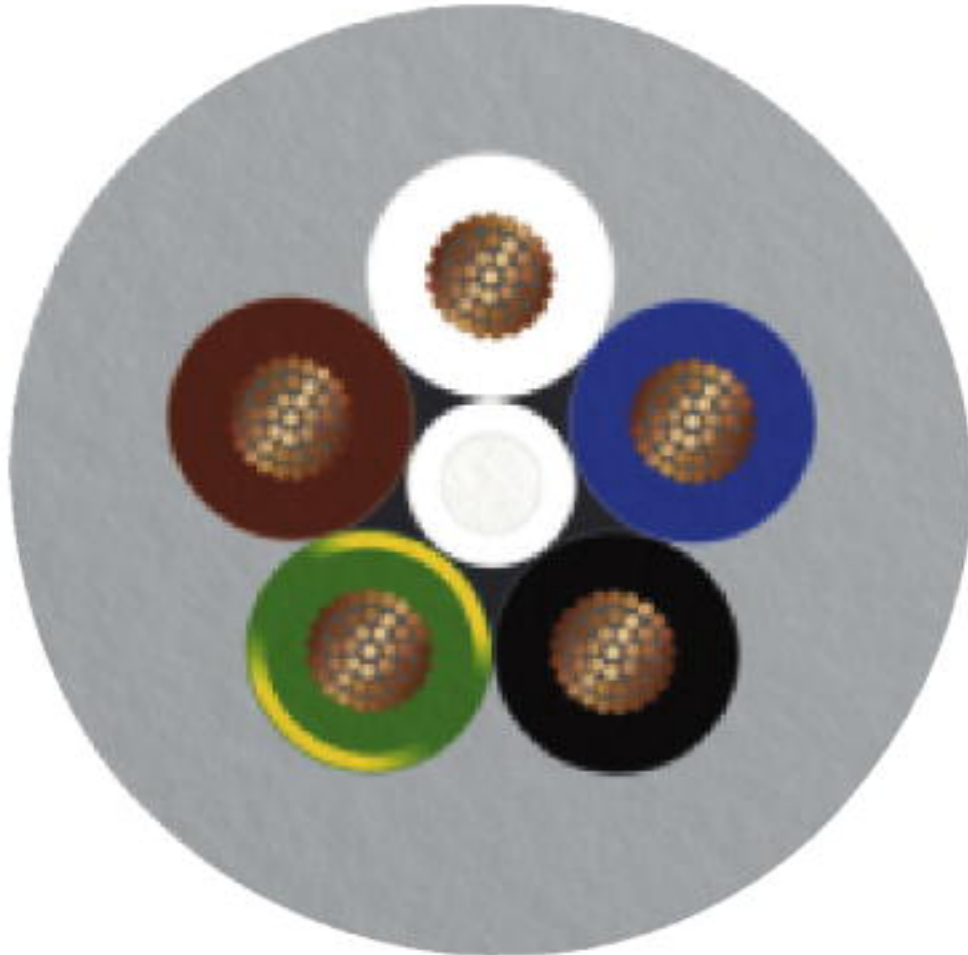

PVC gray [500]

Sensor/actuator cable - SAC-5P-MS-FR-3L SCO/.../... - 1542431

Cable cross section

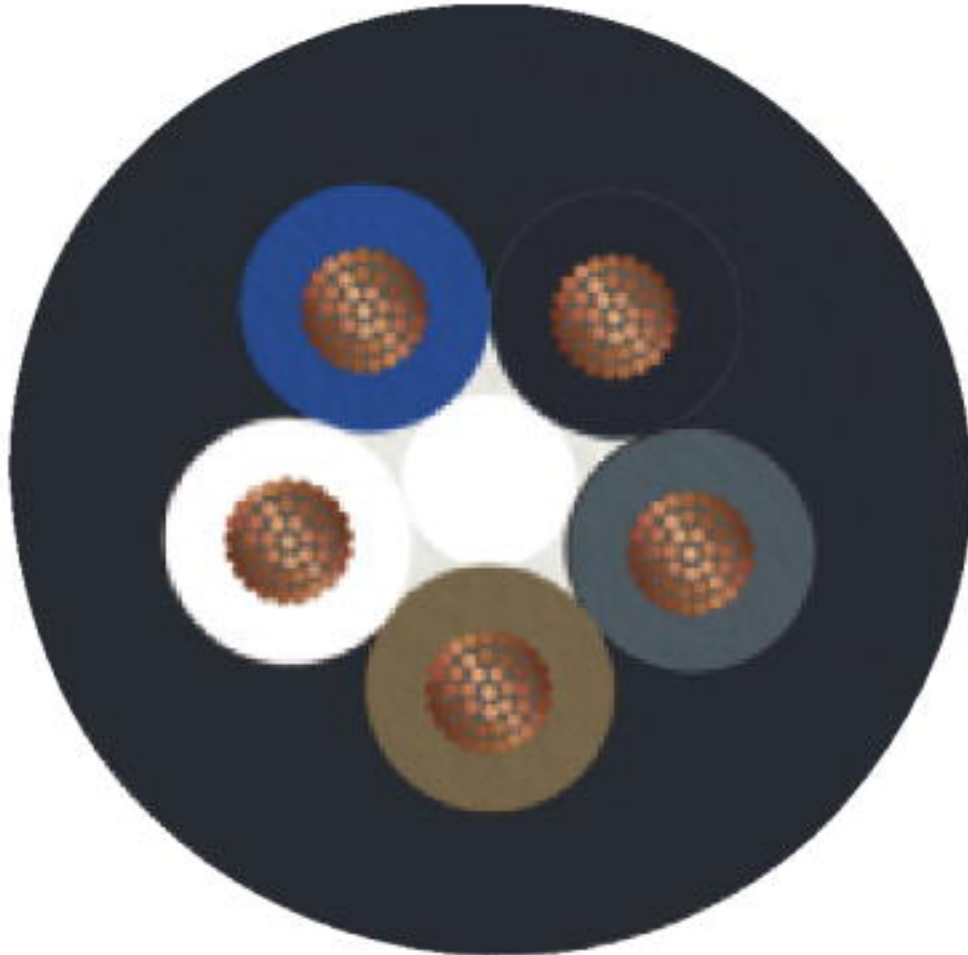

PVC black 5th conductor gray [515]

Sensor/actuator cable - SAC-5P-MS-FR-3L SCO/.../... - 1542431

Cable cross section

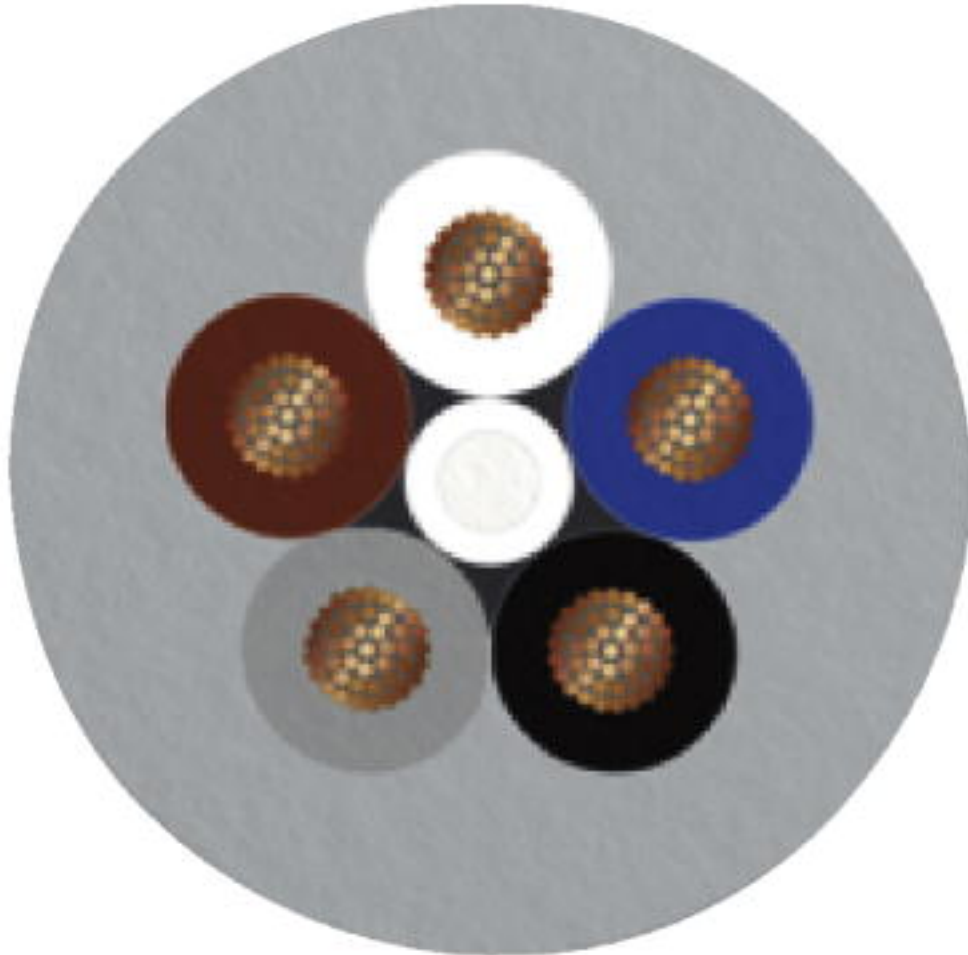

PVC gray 5th conductor gray [520]

Sensor/actuator cable - SAC-5P-MS-FR-3L SCO/.../... - 1542431

Cable cross section

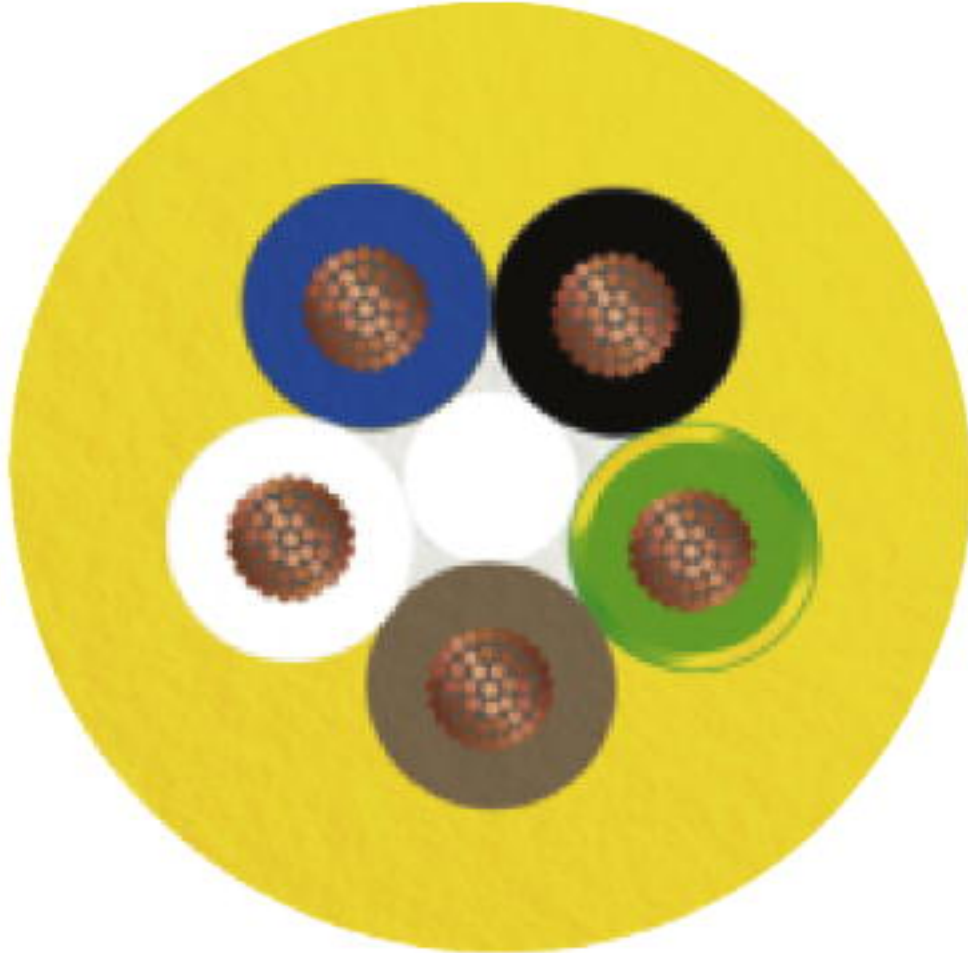

PVC yellow [540]

Sensor/actuator cable - SAC-5P-MS-FR-3L SCO/.../... - 1542431

Cable cross section

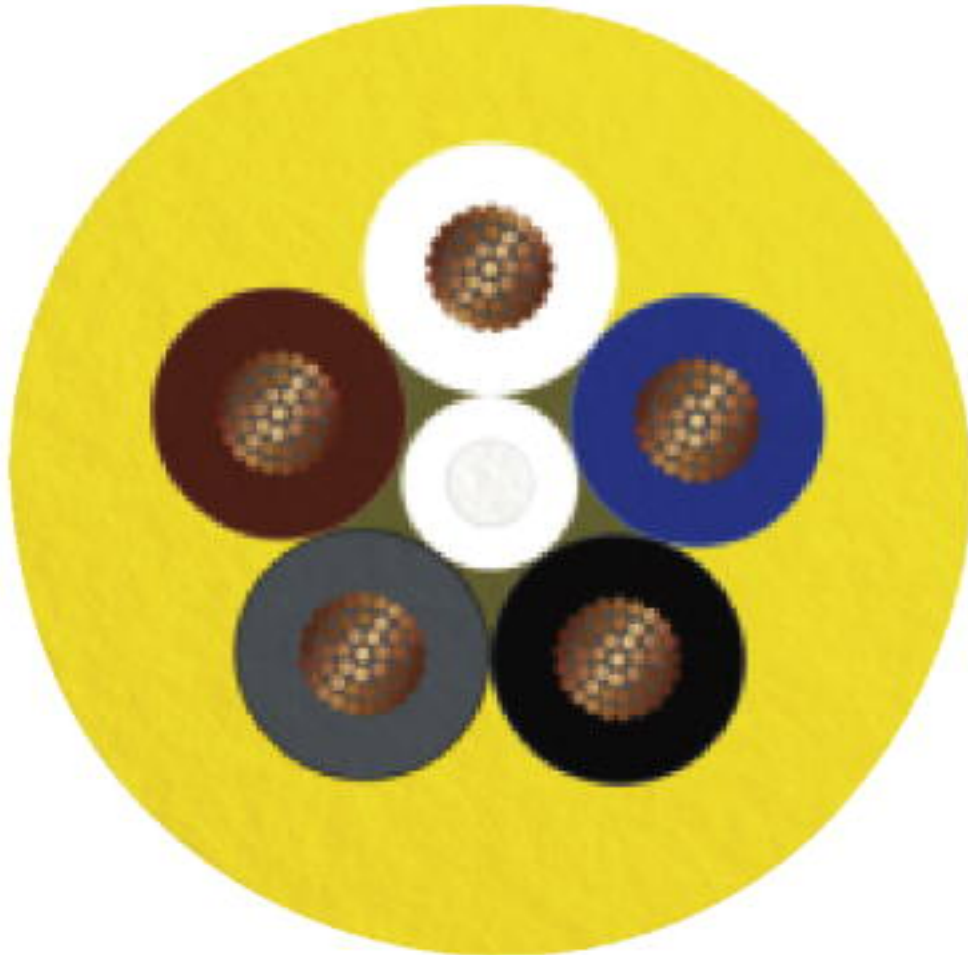

PVC yellow 105 °C [542]

Sensor/actuator cable - SAC-5P-MS-FR-3L SCO/.../... - 1542431

Cable cross section

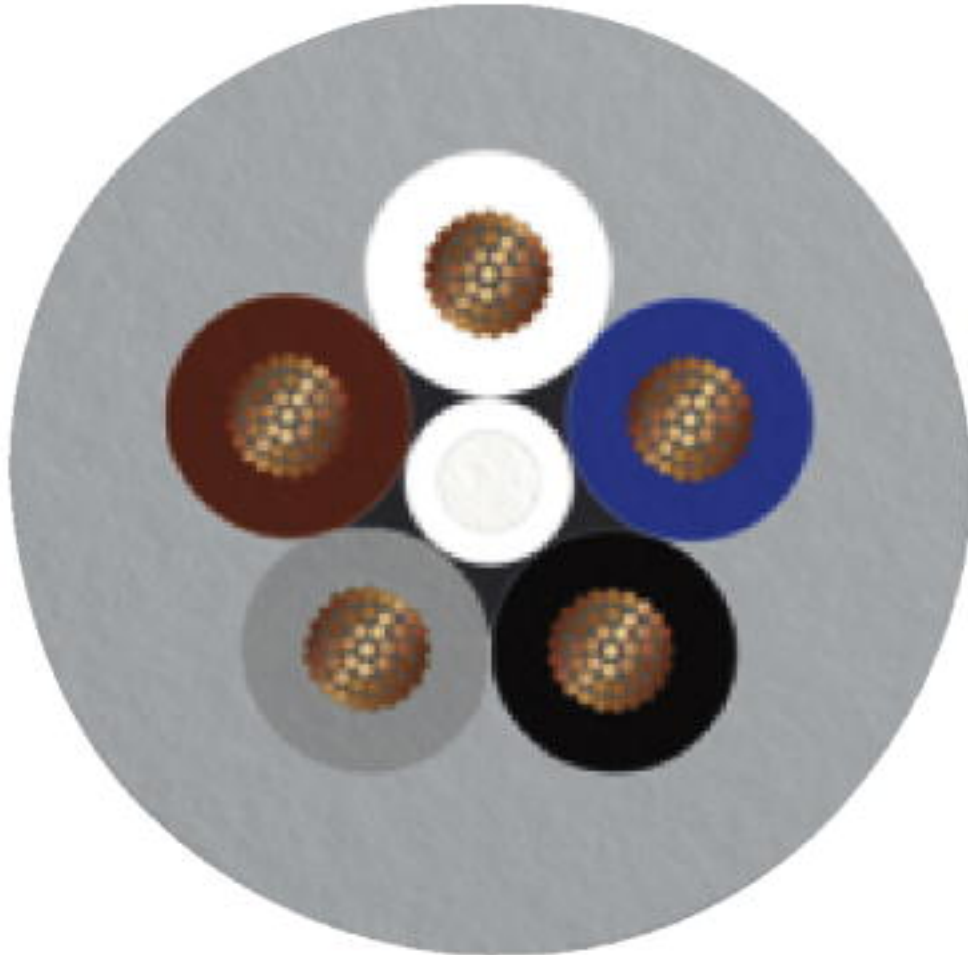

Gray, highly flexible PUR [800]

Sensor/actuator cable - SAC-5P-MS-FR-3L SCO/.../... - 1542431

Cable cross section

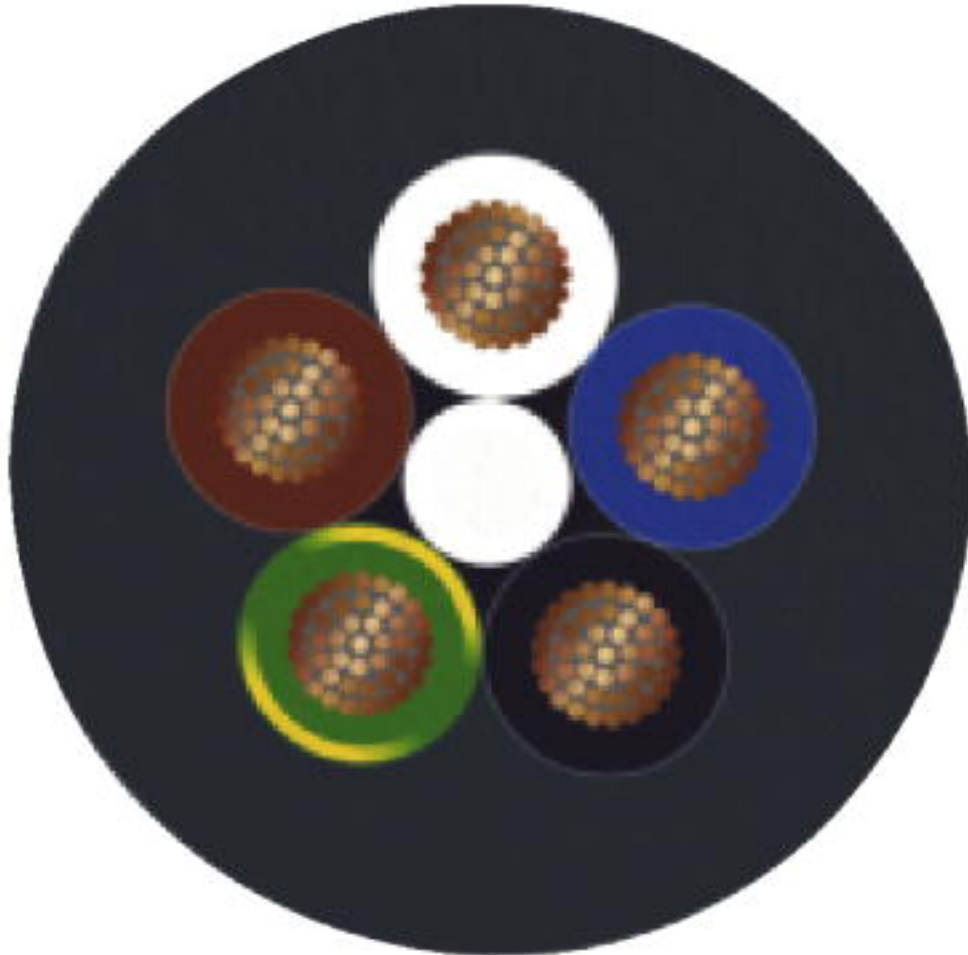

PVC black [PVC]

Classifications

eCl@ss

eCl@ss 4.0	27060306
eCl@ss 4.1	27060306
eCl@ss 5.0	27061801
eCl@ss 5.1	27061800
eCl@ss 6.0	27279200
eCl@ss 7.0	27279218
eCl@ss 8.0	27279218
eCl@ss 9.0	27060311

Sensor/actuator cable - SAC-5P-MS-FR-3L SCO/.../... - 1542431

Classifications

ETIM

ETIM 3.0	EC001855
ETIM 4.0	EC001855
ETIM 5.0	EC001855
ETIM 6.0	EC001855

UNSPSC

UNSPSC 6.01	31251501
UNSPSC 7.0901	31251501
UNSPSC 11	31251501
UNSPSC 12.01	31251501
UNSPSC 13.2	31251501
UNSPSC 19.0	31251501

Approvals

Approvals

Approvals

UL Listed / cUL Listed / EAC / cULus Listed

Ex Approvals

Approval details

UL Listed		http://database.ul.com/cgi-bin/XYV/template/LISEXT/1FRAME/index.htm	FILE E 221474
Nominal voltage UN		24 V	
Nominal current IN		4 A	

cUL Listed		http://database.ul.com/cgi-bin/XYV/template/LISEXT/1FRAME/index.htm	FILE E 221474
Nominal voltage UN		24 V	
Nominal current IN		4 A	

Sensor/actuator cable - SAC-5P-MS-FR-3L SCO/.../... - 1542431

Approvals

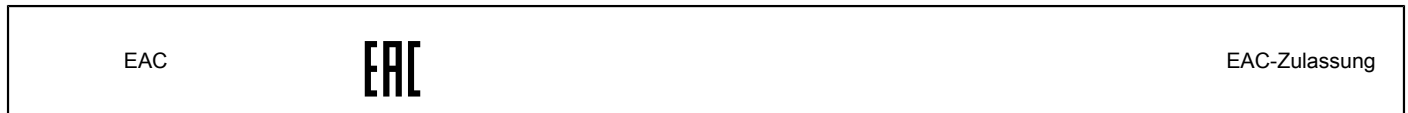

Accessories

Accessories

Conductor marking

Insert label - PABA WH/23 - 1013779



Insert label, Strip, white, unlabeled, can be labeled with: CMS-P1-PLOTTER, mounting type: thread on, cable diameter range: 1.5 ... 35 mm, lettering field size: 23 x 4 mm, Number of individual labels: 20

Insert label - PABA YE/23 - 1013782



Insert label, Strip, yellow, unlabeled, can be labeled with: CMS-P1-PLOTTER, mounting type: thread on, cable diameter range: 1.5 ... 35 mm, lettering field size: 23 x 4 mm, Number of individual labels: 20

Marker pen

Marker pen - B-STIFT - 1051993



Marker pen, for manual labeling of unprinted Zack strips, smear-proof and waterproof, line thickness 0.5 mm

Plug for cable screw gland

Sensor/actuator cable - SAC-5P-MS-FR-3L SCO/.../... - 1542431

Accessories

Screw plug - PROT-M12 MS-PA-CHAIN - 1430899

M12 sealing cap with fixing band, for sensor cables, for free M12 sockets



Protective cap

Sealing cap - PROT-M12 FS-PA-CHAIN - 1430873

M12 sealing cap made of plastic with fixing band, for sensor cables, for free M12 plugs



Safety locking

Locking clip - SAC-M12-EXCLIP-M - 1558988



Locking clip for the pin side of sensor/actuator cables with M12 connector and M12 connectors for assembly, for knurl diameter: 15 mm or for Allen key with a wrench size of 14 mm, prevents the disconnection of plug-in connections without tools

Locking clip - SAC-M12-EXCLIP-F - 1558991



Locking clip for the socket side of sensor/actuator cables with M12 connector and M12 connectors for assembly, for knurl diameter: 15 mm or for Allen key with a wrench size of 14 mm, prevents the disconnection of plug-in connections without tools

Screwdriver tools

Adapter insert - TSD-M SAC-BIT ADAPTER - 1212600



Adapter bit for TSD-M...torque tools, E6.3-1/4" drive with 4 mm hexagon to accommodate SAC bits

Sensor/actuator cable - SAC-5P-MS-FR-3L SCO/.../... - 1542431

Accessories

Tool - SAC BIT M12-D15 - 1208432



Nut for assembling sensor/actuator cables with M12 connector and M12 connectors for assembly, with a knurl diameter of 15 mm, for 4 mm hexagonal drive

Torque tool

Torque screwdriver - TSD 04 SAC - 1208429



Torque screwdriver, with preset torque of 0.4 Nm and 4 mm hexagonal drive for M12 connectors

Torque screwdriver - TSD-M 1,2NM - 1212224



Torque screw driver, accuracy as per EN ISO 6789 standard, adjustable from 0.3 - 1.2 Nm

Phoenix Contact 2020 © - all rights reserved
<http://www.phoenixcontact.com>

PHOENIX CONTACT GmbH & Co. KG
Flachsmarktstr. 8
32825 Blomberg
Germany
Tel. +49 5235 300
Fax +49 5235 3 41200
<http://www.phoenixcontact.com>