

## Sensor/actuator cable - SAC-3P-MS-M8FR-2L SCO/.../... - 1535710

Please be informed that the data shown in this PDF Document is generated from our Online Catalog. Please find the complete data in the user's documentation. Our General Terms of Use for Downloads are valid (<http://phoenixcontact.com/download>)



Sensor/actuator cable, 3-position, Variable cable type, Plug straight M12 SPEEDCON, coding: A, on Socket angled M8, with 2 LEDs, cable length: Free input (0.2 ... 40.0 m)

### Your advantages

- ✓ Easy and safe: 100% electrically tested plug-in components
- ✓ Save time, thanks to installation with SPEEDCON fast locking system
- ✓ Flexible solutions - configurable materials with variable cable types and cable lengths
- ✓ Convenient: increased machine availability thanks to quick and easy diagnostics



### Key Commercial Data

Packing unit	1 pc
Minimum order quantity	25 pc

### Technical data

#### Dimensions

Length of cable	Free input (0.2 ... 40.0 m)
-----------------	-----------------------------

#### Ambient conditions

Ambient temperature (operation)	-25 °C ... 90 °C (Plug / socket)
Degree of protection	IP65
	IP67
	IP68

#### General

Rated current at 40°C	4 A
Rated voltage	24 V
	24 V DC
Number of positions	3
Insulation resistance	≥ 100 MΩ
Coding	A - standard
Standards/regulations	M12 connector IEC 61076-2-101

# Sensor/actuator cable - SAC-3P-MS-M8FR-2L SCO/.../... - 1535710

## Technical data

### General

	M8 connector IEC 61076-2-104
Status display	2 LEDs
Protective circuit/component	unwired
Overvoltage category	II
Degree of pollution	3
Test voltage	1500 V
Insertion/withdrawal cycles	≥ 100
Torque	0.4 Nm (M12 connector)
	0.2 Nm (M8 connectors)

### Material

Flammability rating according to UL 94	HB
Contact material	CuSn
Contact surface material	Ni/Au
Contact carrier material	TPU GF
Material of grip body	TPU, hardly inflammable, self-extinguishing
Material, knurls	Zinc die-cast, nickel-plated
Sealing material	NBR

### Line characteristics

Note	This item is a sensor/actuator cable with a freely selectable cable type. The technical data for all possible cable types is listed in the table below.
------	---------------------------------------------------------------------------------------------------------------------------------------------------------

### Standards and Regulations

Standards/specifications	M12 connector IEC 61076-2-101
	M8 connector IEC 61076-2-104
Flammability rating according to UL 94	HB

### PUR/PVC gray [100]

Cable type	PUR/PVC gray
Cable type (abbreviation)	100
Cable abbreviation	LiYY-11Y
Conductor cross section	0.25 mm <sup>2</sup>
AWG signal line	24
Conductor structure signal line	32x 0.10 mm
Core diameter including insulation	1.32 mm ±0.02 mm
Thickness, insulation	≥ 0.23 mm (Core insulation)
	≥ 0.38 mm (Outer cable sheath)
	approx. 3.5 mm ±0.1 mm (Inner sheath)
Wire colors	brown, blue, black
Overall twist	3 wires, twisted
External sheath, color	gray RAL 7001
External cable diameter D	4.4 mm ±0.2 mm

## Sensor/actuator cable - SAC-3P-MS-M8FR-2L SCO/.../... - 1535710

### Technical data

#### PUR/PVC gray [100]

Smallest bending radius, fixed installation	22 mm
Smallest bending radius, movable installation	44 mm
Number of bending cycles	2000000
Bending radius	44 mm
Traversing path	5 m
Traversing rate	3 m/s
Cable weight	27 kg/km
Outer sheath, material	PUR
Material, inner sheath	PVC
Material conductor insulation	PVC
Conductor material	Bare Cu litz wires
Insulation resistance	≥ 100 MΩ*km (at 20 °C)
Conductor resistance	max. 78 Ω/km (at 20 °C)
Nominal voltage, cable	≤ 300 V
Test voltage, cable	≥ 3000 V
Flame resistance	As per UL-Style 2464
Ambient temperature (operation)	-25 °C ... 80 °C (cable, fixed installation)
	-5 °C ... 80 °C (cable, flexible installation)

#### PUR/PVC yellow [140]

Cable type	PUR/PVC yellow
Cable type (abbreviation)	140
Cable abbreviation	LiYY-11Y
UL AWM style	20549
Conductor cross section	0.25 mm <sup>2</sup>
AWG signal line	24
Conductor structure signal line	32x 0.10 mm
Core diameter including insulation	1.32 mm ±0.02 mm
Thickness, insulation	≥ 0.23 mm (Core insulation)
	≥ 0.38 mm (Outer cable sheath)
	approx. 0.35 mm (Inner sheath)
Wire colors	brown, blue, black
Overall twist	3 wires, twisted
External sheath, color	yellow
External cable diameter D	4.4 mm ±0.2 mm
Smallest bending radius, fixed installation	44 mm
Smallest bending radius, movable installation	44 mm
Number of bending cycles	2000000
Bending radius	44 mm
Traversing path	5 m
Traversing rate	3 m/s

## Sensor/actuator cable - SAC-3P-MS-M8FR-2L SCO/.../... - 1535710

### Technical data

#### PUR/PVC yellow [140]

Cable weight	27 kg/km
Outer sheath, material	PUR
Material, inner sheath	PVC
Material conductor insulation	PVC
Conductor material	Bare Cu litz wires
Insulation resistance	$\geq 100 \text{ M}\Omega \cdot \text{km}$ (at 20 °C)
Conductor resistance	max. 78 $\Omega/\text{km}$ (at 20 °C)
Nominal voltage, cable	$\leq 300 \text{ V}$
Test voltage, cable	$\geq 3000 \text{ V}$
Flame resistance	in accordance with DIN UL-Style 20549
Ambient temperature (operation)	-25 °C ... 80 °C (cable, fixed installation)
	-5 °C ... 80 °C (cable, flexible installation)

#### PUR halogen-free orange [180]

Cable type	PUR halogen-free orange
Cable type (abbreviation)	180
Cable abbreviation	Li9Y-11Y
UL AWM style	20549
Conductor cross section	3x 0.25 mm <sup>2</sup> (Signal line)
AWG signal line	24
Conductor structure signal line	32x 0.10 mm
Core diameter including insulation	1.17 mm $\pm$ 0.02 mm (Signal line)
Thickness, insulation	$\geq 0.21 \text{ mm}$ (Core insulation)
	approx. 0.9 mm (Outer cable sheath)
Wire colors	brown, blue, black
Overall twist	3 wires, twisted
External sheath, color	orange RAL 2003
External cable diameter D	4.4 mm $\pm$ 0.15 mm
Smallest bending radius, fixed installation	22 mm
Smallest bending radius, movable installation	44 mm
Number of bending cycles	4000000
Bending radius	44 mm
Traversing path	10 m
Traversing rate	3 m/s
Acceleration	10 m/s <sup>2</sup>
Cable weight	24 kg/km
Outer sheath, material	PUR
Material conductor insulation	PP
Conductor material	Bare Cu litz wires
Insulation resistance	$\geq 10 \text{ G}\Omega \cdot \text{km}$ (at 20 °C)
Conductor resistance	max. 78 $\Omega/\text{km}$ (at 20 °C)

# Sensor/actuator cable - SAC-3P-MS-M8FR-2L SCO/.../... - 1535710

## Technical data

### PUR halogen-free orange [180]

Nominal voltage, cable	≤ 300 V
Test voltage, cable	≥ 3000 V
Flame resistance	in accordance with DIN UL-Style 20549
	in accordance with UL 758/1581 FT2
Halogen-free	in accordance with DIN VDE 0472 part 815
Resistance to oil	in accordance with DIN EN 60811-2-1
Other resistance	hydrolysis and microbe resistant
	Resistant to salt water
Ambient temperature (operation)	-40 °C ... 80 °C (cable, fixed installation)
	-25 °C ... 80 °C (cable, flexible installation)

### PUR halogen-free gray [280]

Cable type	PUR halogen-free gray
Cable type (abbreviation)	280
Cable abbreviation	Li9Y11Y-HF
UL AWM style	20549 / 10493 (80°C/300 V)
Conductor cross section	3x 0.25 mm <sup>2</sup>
AWG signal line	24
Conductor structure signal line	32x 0.10 mm
Core diameter including insulation	1.17 mm ±0.02 mm
Thickness, insulation	≥ 0.21 mm (Core insulation)
Wire colors	brown, blue, black
Overall twist	3 wires, twisted
Length of twist, overall twist	40 mm
External sheath, color	gray RAL 7001
Outer sheath thickness	approx. 0.5 mm
External cable diameter D	3.6 mm ±0.15 mm
Smallest bending radius, fixed installation	18 mm
Smallest bending radius, movable installation	36 mm
Number of bending cycles	10000000
Bending radius	44 mm
Traversing path	10 m
Traversing rate	3 m/s
Acceleration	10 m/s <sup>2</sup>
Cable weight	18 kg/km
Outer sheath, material	PUR
Material conductor insulation	PP
Conductor material	Bare Cu litz wires
Insulation resistance	≥ 100 GΩ*km (at 20 °C)
Conductor resistance	≤ 78 Ω/km (at 20 °C)
Nominal voltage, cable	≤ 300 V

## Sensor/actuator cable - SAC-3P-MS-M8FR-2L SCO/.../... - 1535710

### Technical data

#### PUR halogen-free gray [280]

Test voltage, cable	≥ 3000 V
Special properties	Flexible cable conduit capable
	Silicone-free
	Free of substances which would hinder coating with paint or varnish
Flame resistance	in accordance with UL 758/1581 FT2
	DIN EN 60332-2-2 (20 s)
Halogen-free	in accordance with DIN VDE 0472 part 815
Resistance to oil	in accordance with DIN EN 60811-2-1
Other resistance	hydrolysis and microbe resistant
	Highly resistant to acids, alkaline solutions and solvents
	Resistant to salt water
	partly UV-resistant in accordance with DIN EN ISO 4892-2-A
Ambient temperature (operation)	-40 °C ... 80 °C (cable, fixed installation)
	-25 °C ... 80 °C (cable, flexible installation)

#### PVC gray [500]

Cable type	PVC gray
Cable type (abbreviation)	500
Cable abbreviation	LiYY
Conductor cross section	0.25 mm <sup>2</sup>
AWG signal line	24
Conductor structure signal line	32x 0.10 mm
Core diameter including insulation	1.25 mm ±0.02 mm
Thickness, insulation	≥ 0.23 mm (Core insulation)
	≥ 0.76 mm (Outer cable sheath)
Wire colors	brown, blue, black
Overall twist	3 wires, twisted
External sheath, color	gray RAL 7001
External cable diameter D	4.4 mm ±0.15 mm
Cable weight	29 kg/km
Outer sheath, material	PVC
Material conductor insulation	PVC
Conductor material	Bare Cu litz wires
Insulation resistance	≥ 1 GΩ*km (at 20 °C)
Conductor resistance	max. 78 Ω/km (at 20 °C)
Nominal voltage, cable	≥ 300 V
Test voltage, cable	≤ 3000 V
Flame resistance	As per UL-Style 2464
Ambient temperature (operation)	-25 °C ... 80 °C (cable, fixed installation)
	-5 °C ... 80 °C (cable, flexible installation)

#### Gray, highly flexible PUR [800]

# Sensor/actuator cable - SAC-3P-MS-M8FR-2L SCO/.../... - 1535710

## Technical data

Gray, highly flexible PUR [800]

Note	Due to the extremely robust outer sheath, this cable should only be stripped in 5 cm increments.
Cable type	Gray, highly flexible PUR
Cable type (abbreviation)	800
Cable abbreviation	LiF9Y11Y
UL AWM style	20549
Conductor cross section	3x 0.25 mm <sup>2</sup> (Signal line)
AWG signal line	24
Conductor structure signal line	32x 0.10 mm
Core diameter including insulation	1.2 mm ±0.05 mm (Signal line)
Wire colors	brown, blue, black
Overall twist	3 wires, twisted
External sheath, color	gray RAL 7001
External cable diameter D	4.3 mm ±0.2 mm
Minimum bending radius, fixed installation	4 x D
Minimum bending radius, flexible installation	7.5 x D
Number of bending cycles	10000000
Minimum bending radius, drag chain applications	7,5 x D
Traversing path	5 m
Traversing rate	3.3 m/s
Acceleration	5 m/s <sup>2</sup>
Number of bending cycles	15000000
Bending radius	50 mm
Traversing path	0.9 m
Traversing rate	5 m/s
Acceleration	30 m/s <sup>2</sup>
Torsion force	± 360 °/m (1 000 000 torsion cycles)
Cable weight	24 kg/km
Outer sheath, material	PUR
Material conductor insulation	PP
Conductor material	Bare Cu litz wires
Insulation resistance	≥ 20 MΩ*km
Conductor resistance	approx. 76 Ω/km
Nominal voltage, cable	300 V
Test voltage, cable	2000 V
Special properties	Cable jacket is welding spark-resistant, recyclable, matt, low-adhesion, abrasion-resistant, flame-retardant, and self-extinguishing
	Free from silicone and cadmium
	Free of substances which would hinder coating with paint or varnish
Flame resistance	in accordance with UL 758/1581 FT2
Halogen-free	in accordance with DIN VDE 0472 part 815

## Sensor/actuator cable - SAC-3P-MS-M8FR-2L SCO/.../... - 1535710

### Technical data

Gray, highly flexible PUR [800]

Resistance to oil	in accordance with DIN EN 60811-2-1
Other resistance	Highly resistant to acids, alkaline solutions and solvents
	Silicone-free
Ambient temperature (operation)	-40 °C ... 80 °C (cable, fixed installation)
	-25 °C ... 80 °C (cable, flexible installation)

PUR halogen-free black [PUR]

Cable type	PUR halogen-free black
Cable type (abbreviation)	PUR
Cable abbreviation	Li9Y11Y-HF
UL AWM style	20549 / 10493 (80°C/300 V)
Conductor cross section	3x 0.25 mm <sup>2</sup>
AWG signal line	24
Conductor structure signal line	32x 0.10 mm
Core diameter including insulation	1.17 mm ±0.02 mm
Thickness, insulation	≥ 0.21 mm (Core insulation)
Wire colors	brown, blue, black
Overall twist	3 wires, twisted
Length of twist, overall twist	40 mm
External sheath, color	black-gray RAL 7021
Outer sheath thickness	approx. 0.5 mm
External cable diameter D	3.6 mm ±0.15 mm
Smallest bending radius, fixed installation	18 mm
Smallest bending radius, movable installation	36 mm
Number of bending cycles	10000000
Bending radius	44 mm
Traversing path	10 m
Traversing rate	3 m/s
Acceleration	10 m/s <sup>2</sup>
Cable weight	18 kg/km
Outer sheath, material	PUR
Material conductor insulation	PP
Conductor material	Bare Cu litz wires
Insulation resistance	≥ 100 GΩ*km (at 20 °C)
Conductor resistance	≤ 78 Ω/km (at 20 °C)
Nominal voltage, cable	≤ 300 V
Test voltage, cable	≥ 3000 V
Special properties	Flexible cable conduit capable
	Silicone-free
	Free of substances which would hinder coating with paint or varnish
Flame resistance	in accordance with UL 758/1581 FT2



# Sensor/actuator cable - SAC-3P-MS-M8FR-2L SCO/.../... - 1535710

## Technical data

### PUR halogen-free black [PUR]

	DIN EN 60332-2-2 (20 s)
Halogen-free	in accordance with DIN VDE 0472 part 815
Resistance to oil	in accordance with DIN EN 60811-2-1
Other resistance	hydrolysis and microbe resistant
	Highly resistant to acids, alkaline solutions and solvents
	Resistant to salt water
	partly UV-resistant in accordance with DIN EN ISO 4892-2-A
Ambient temperature (operation)	-40 °C ... 80 °C (cable, fixed installation)
	-25 °C ... 80 °C (cable, flexible installation)

### PVC black [PVC]

Cable type	PVC black
Cable type (abbreviation)	PVC
Cable abbreviation	LiYY
Conductor cross section	3x 0.25 mm <sup>2</sup> (Signal line)
AWG signal line	24
Conductor structure signal line	32x 0.10 mm
Core diameter including insulation	1.25 mm ±0.02 mm
Thickness, insulation	≥ 0.23 mm (Core insulation)
Wire colors	brown, blue, black
Overall twist	3 wires, twisted
External sheath, color	black RAL 9005
Outer sheath thickness	≥ 0.76 mm
External cable diameter D	4.4 mm ±0.15 mm
Cable weight	29 kg/km
Outer sheath, material	PVC
Material conductor insulation	PVC
Conductor material	Bare Cu litz wires
Insulation resistance	≥ 100 MΩ*km (at 20 °C)
Conductor resistance	max. 78 Ω/km (at 20 °C)
Nominal voltage, cable	≥ 300 V
Test voltage, cable	≤ 3000 V
Flame resistance	As per UL-Style 2464
Ambient temperature (operation)	-25 °C ... 80 °C (cable, fixed installation)
	-5 °C ... 80 °C (cable, flexible installation)

### Environmental Product Compliance

China RoHS	Environmentally friendly use period: unlimited = EFUP-e
	No hazardous substances above threshold values

## Drawings

# Sensor/actuator cable - SAC-3P-MS-M8FR-2L SCO/.../... - 1535710

Dimensional drawing

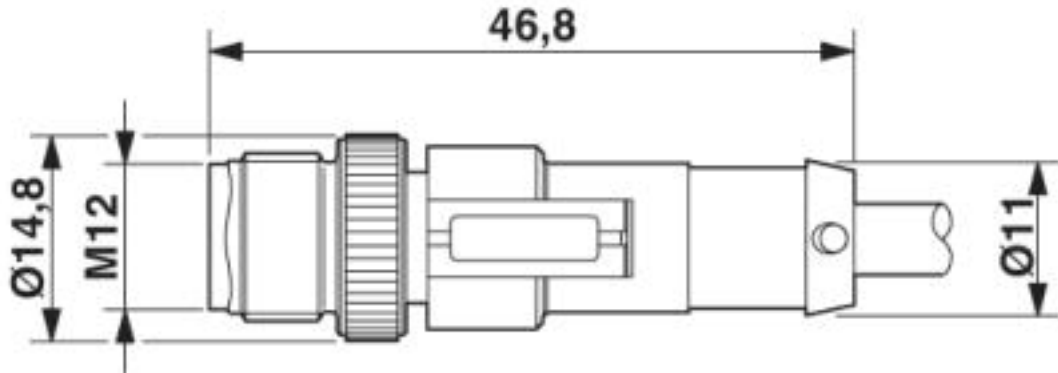

Plug, M12 x 1, straight, shielded

Dimensional drawing

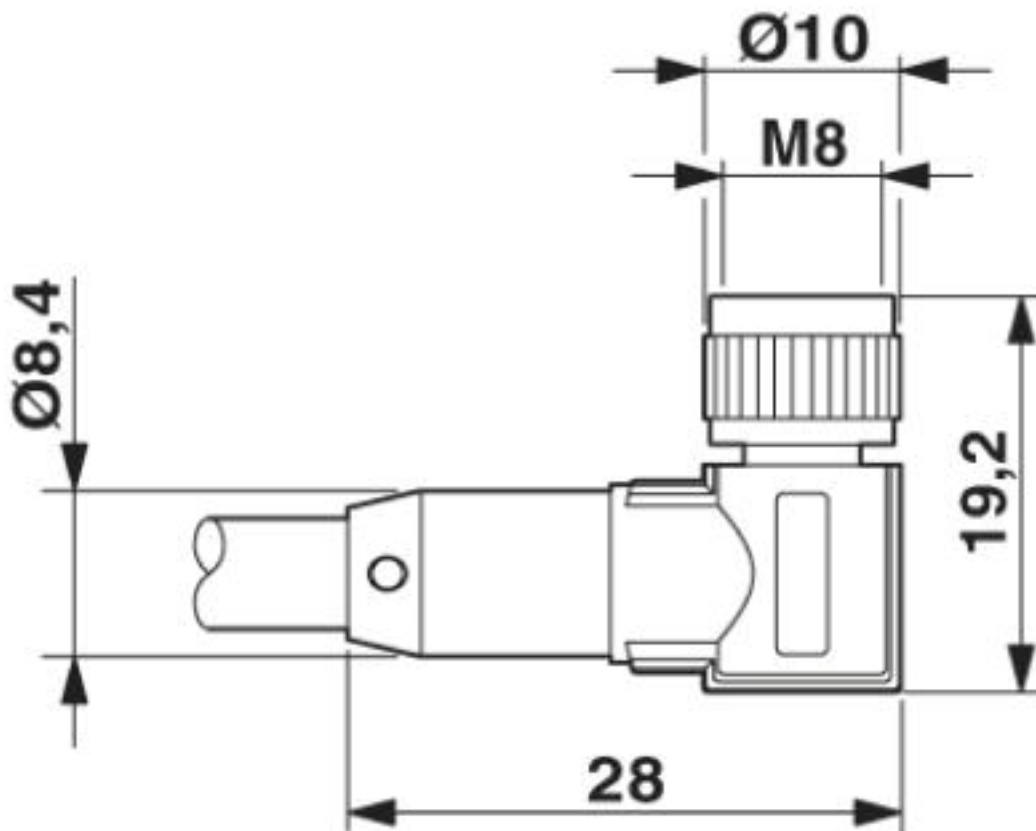

Socket M8 x 1, angled, with LED

# Sensor/actuator cable - SAC-3P-MS-M8FR-2L SCO/.../... - 1535710

Circuit diagram

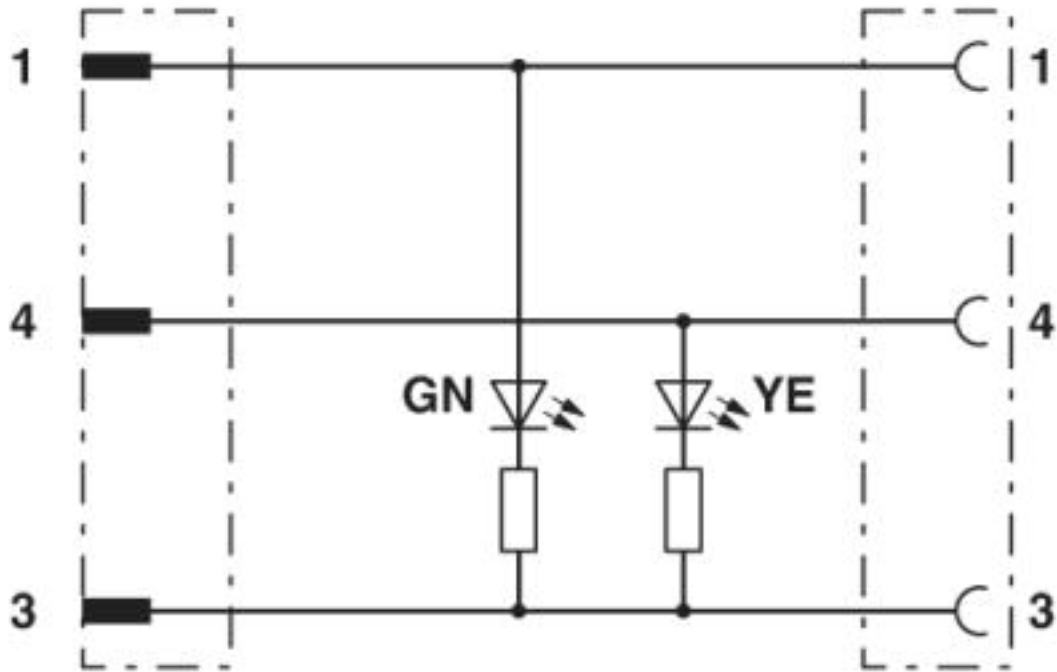

Contact assignment of M12 plugs / M8 sockets

# Sensor/actuator cable - SAC-3P-MS-M8FR-2L SCO/.../... - 1535710

Schematic diagram

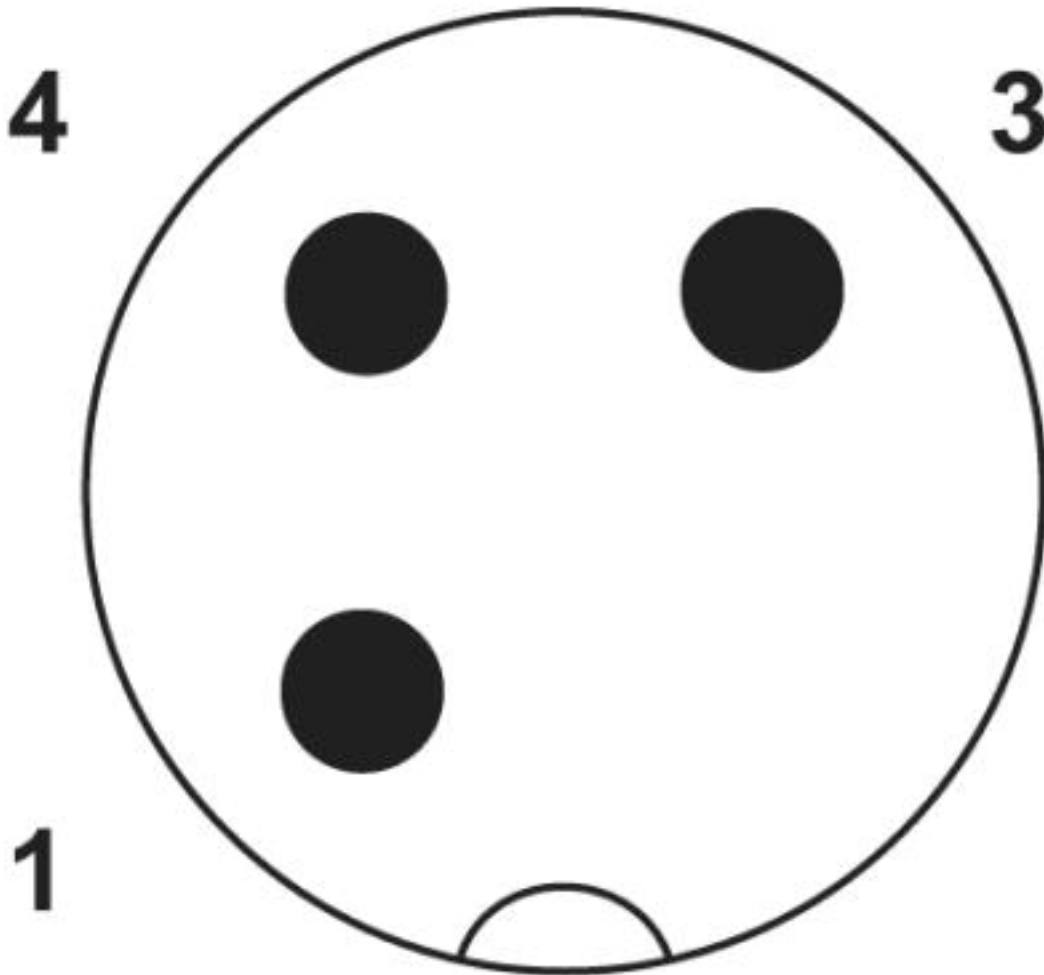

Pin assignment M12 plug, 3-pos., A-coded, view male side

# Sensor/actuator cable - SAC-3P-MS-M8FR-2L SCO/.../... - 1535710

Schematic diagram

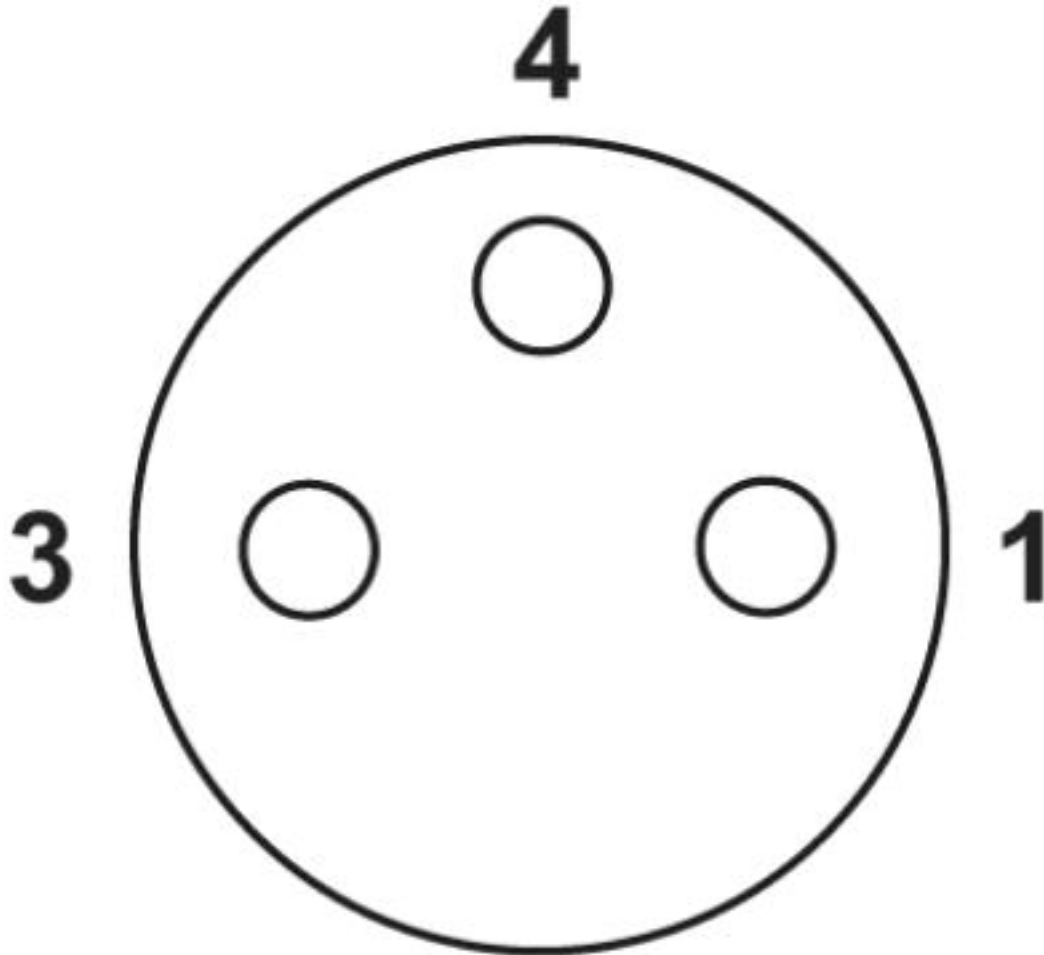

Pin assignment M8 socket, 3-pos., view female side

# Sensor/actuator cable - SAC-3P-MS-M8FR-2L SCO/.../... - 1535710

Schematic diagram

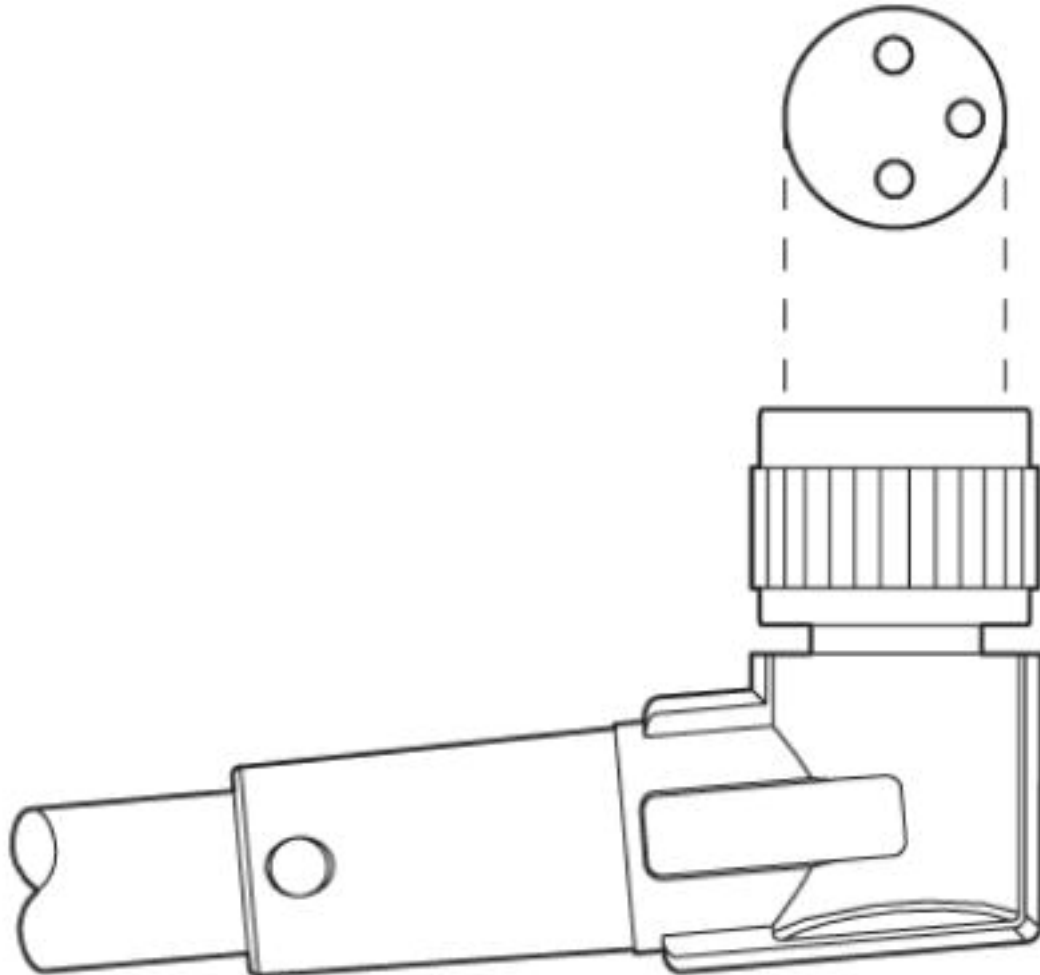

Layout of connector pin assignments

# Sensor/actuator cable - SAC-3P-MS-M8FR-2L SCO/.../... - 1535710

Cable cross section

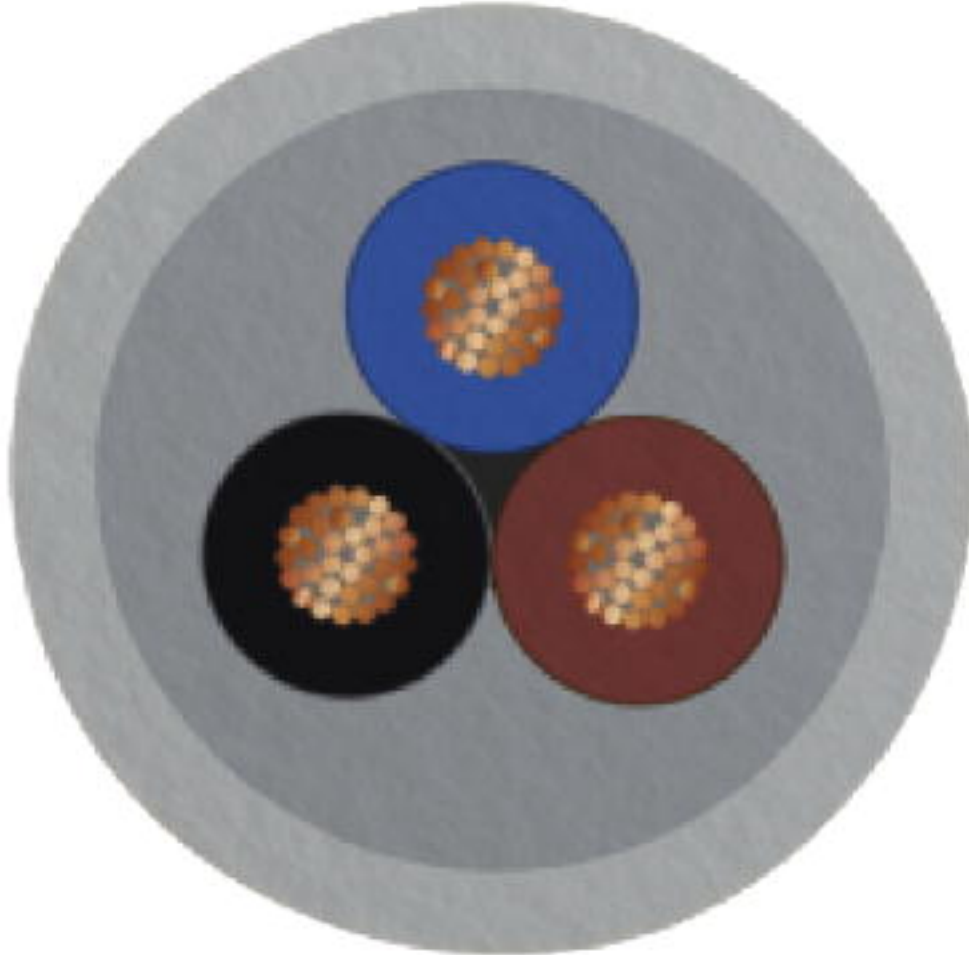

PUR/PVC gray [100]

## Sensor/actuator cable - SAC-3P-MS-M8FR-2L SCO/.../... - 1535710

Cable cross section

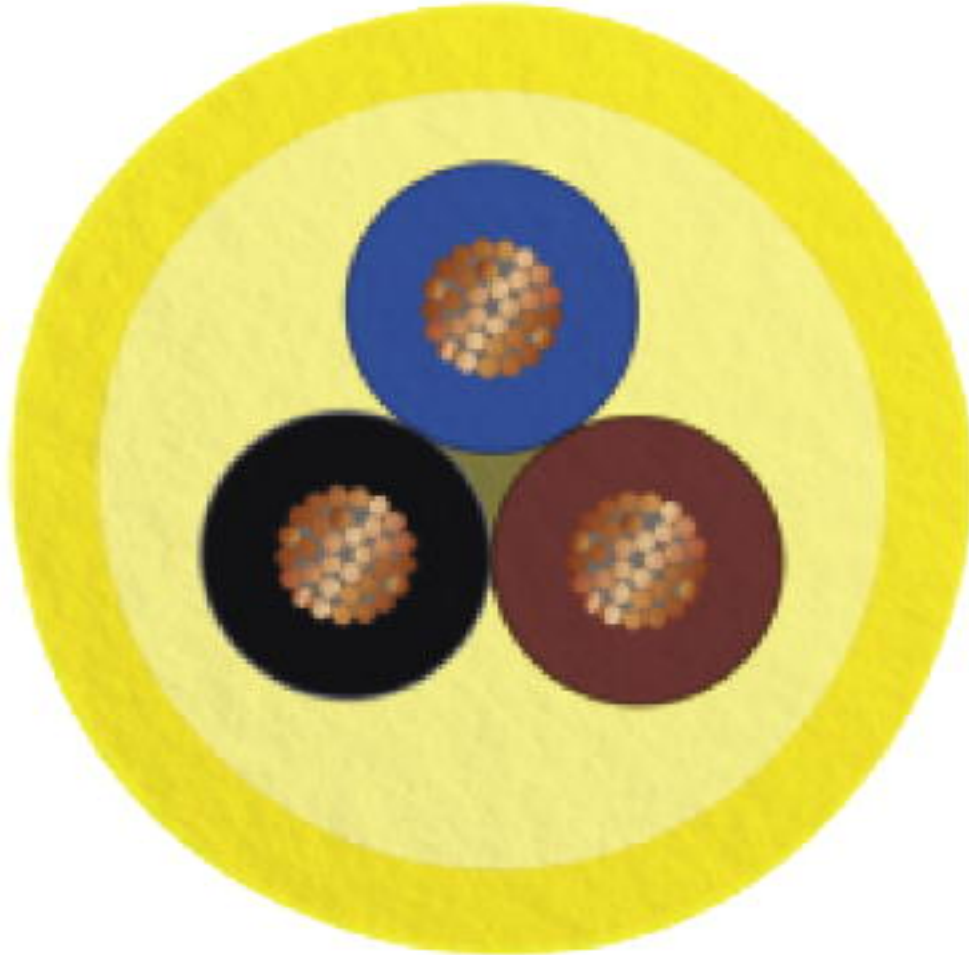

PUR/PVC yellow [140]



## Sensor/actuator cable - SAC-3P-MS-M8FR-2L SCO/.../... - 1535710

Cable cross section

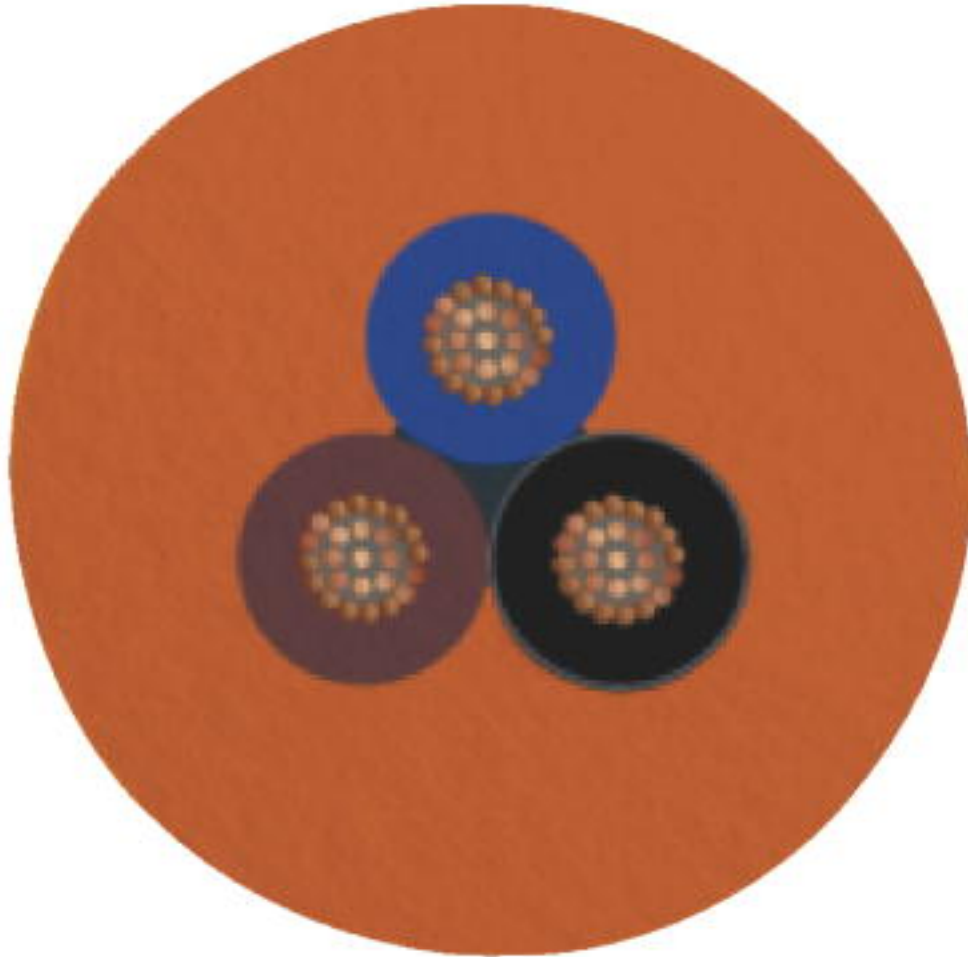

PUR halogen-free orange [180]

## Sensor/actuator cable - SAC-3P-MS-M8FR-2L SCO/.../... - 1535710

Cable cross section

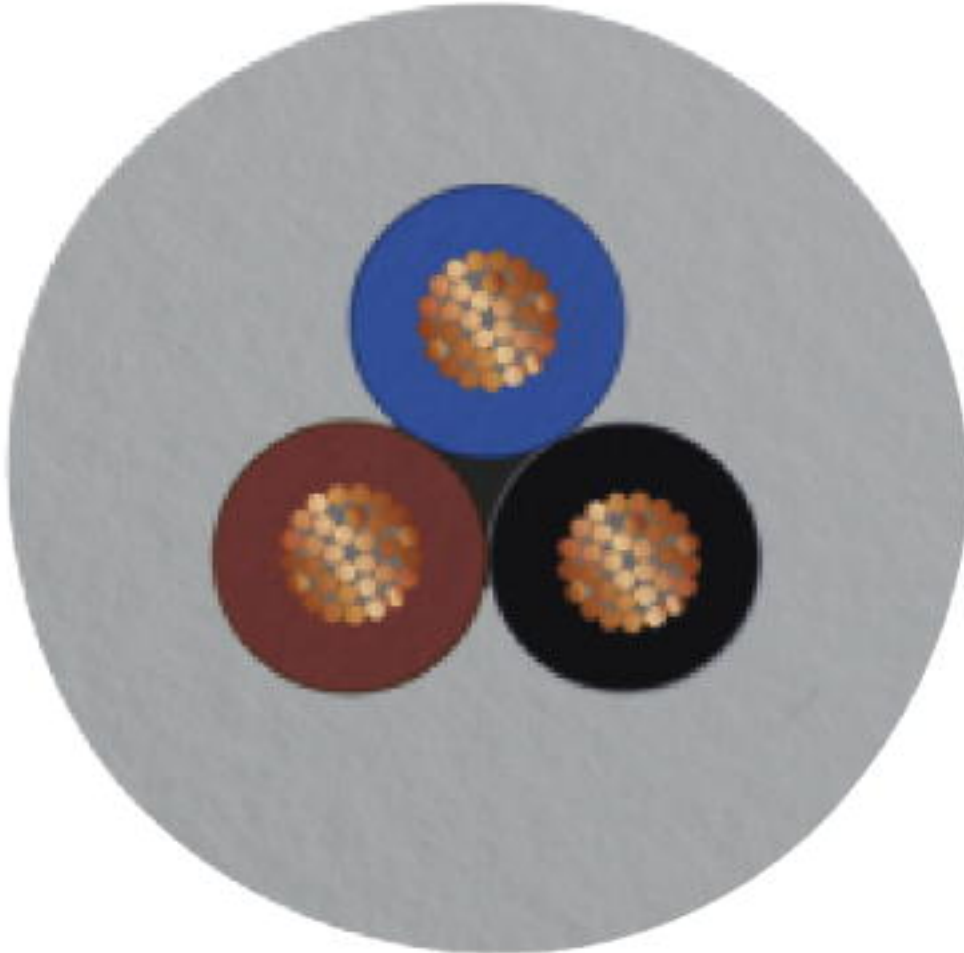

PUR halogen-free gray [280]

## Sensor/actuator cable - SAC-3P-MS-M8FR-2L SCO/.../... - 1535710

Cable cross section

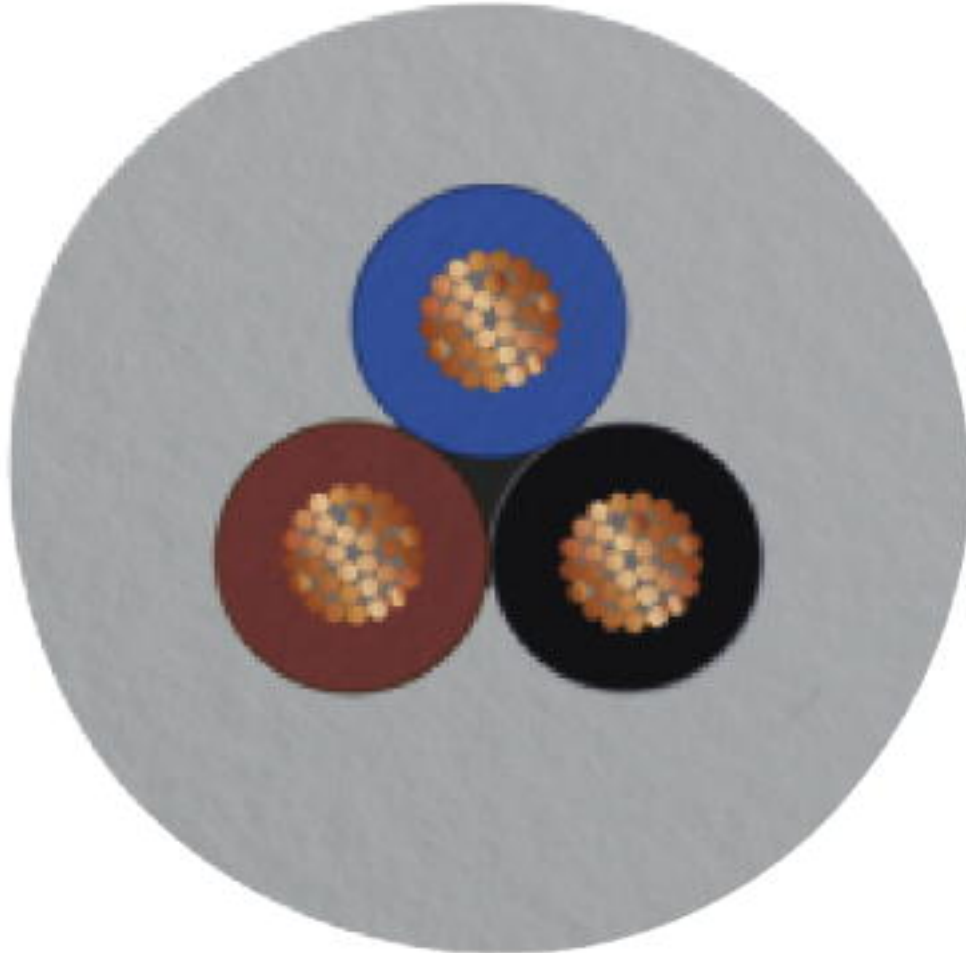

PVC gray [500]

## Sensor/actuator cable - SAC-3P-MS-M8FR-2L SCO/.../... - 1535710

Cable cross section

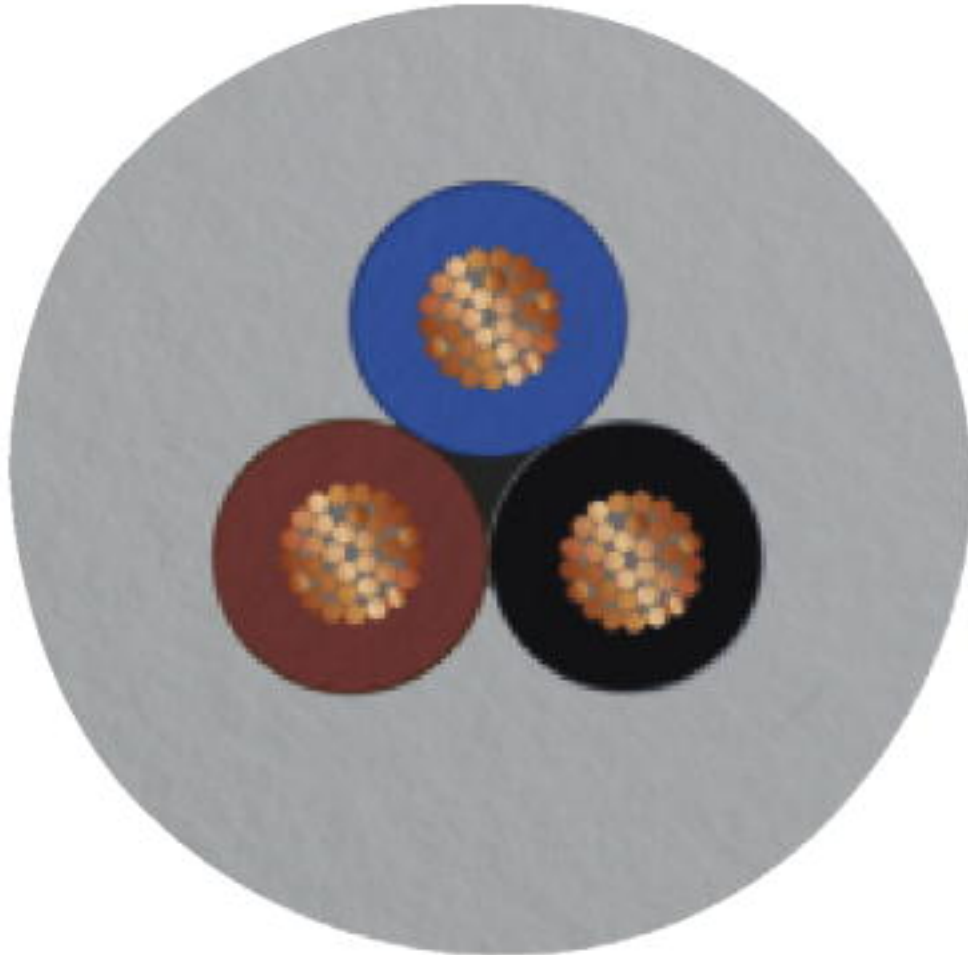

Gray, highly flexible PUR [800]

## Sensor/actuator cable - SAC-3P-MS-M8FR-2L SCO/.../... - 1535710

Cable cross section

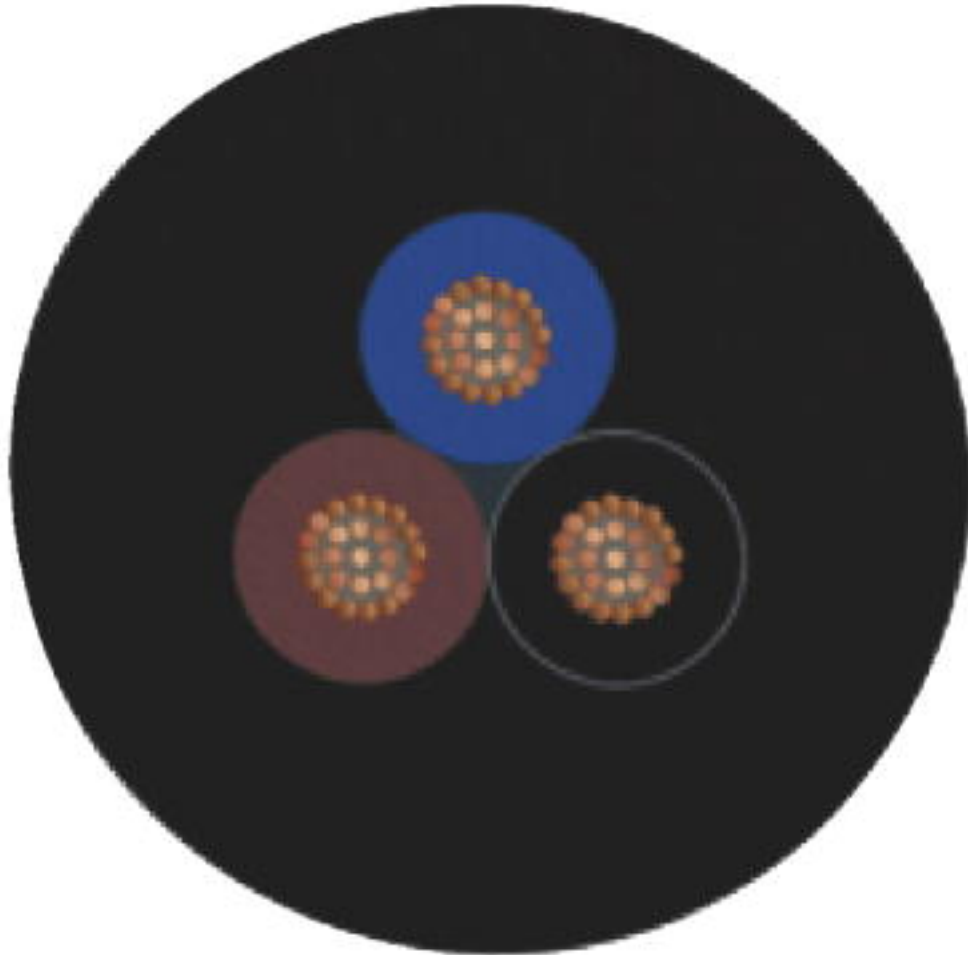

PUR halogen-free black [PUR]

# Sensor/actuator cable - SAC-3P-MS-M8FR-2L SCO/.../... - 1535710

Cable cross section

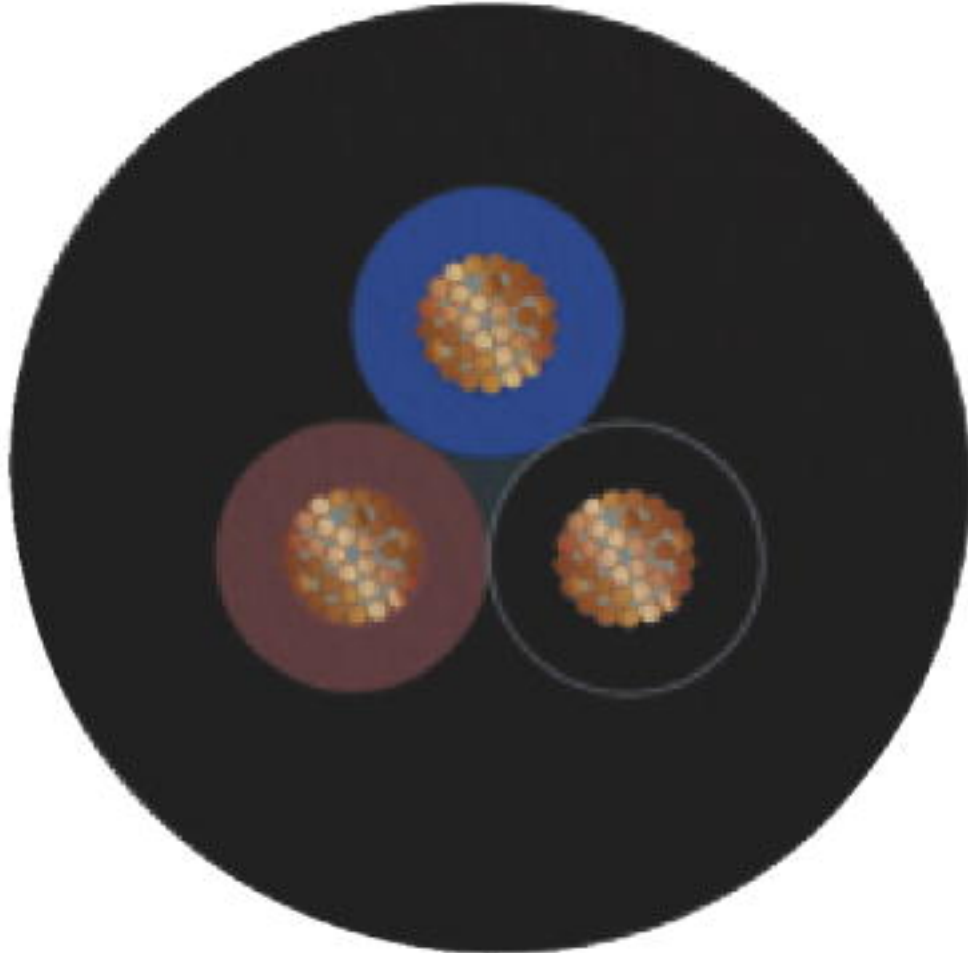

PVC black [PVC]

## Classifications

eCl@ss

eCl@ss 4.0	27060306
eCl@ss 4.1	27060306
eCl@ss 5.0	27061801
eCl@ss 5.1	27061800
eCl@ss 6.0	27279200
eCl@ss 7.0	27279218
eCl@ss 8.0	27279218
eCl@ss 9.0	27060311

# Sensor/actuator cable - SAC-3P-MS-M8FR-2L SCO/.../... - 1535710

## Classifications

### ETIM

ETIM 2.0	EC000830
ETIM 3.0	EC001855
ETIM 4.0	EC001855
ETIM 5.0	EC001855
ETIM 6.0	EC001855

### UNSPSC

UNSPSC 6.01	31251501
UNSPSC 7.0901	31251501
UNSPSC 11	31251501
UNSPSC 12.01	31251501
UNSPSC 13.2	31251501
UNSPSC 19.0	31251501

## Approvals

### Approvals

#### Approvals

UL Listed / cUL Listed / EAC / cULus Listed

#### Ex Approvals

### Approval details

UL Listed		<a href="http://database.ul.com/cgi-bin/XYV/template/LISEXT/1FRAME/index.htm">http://database.ul.com/cgi-bin/XYV/template/LISEXT/1FRAME/index.htm</a>	FILE E 221474
Nominal voltage UN	24 V		
Nominal current IN	4 A		

cUL Listed		<a href="http://database.ul.com/cgi-bin/XYV/template/LISEXT/1FRAME/index.htm">http://database.ul.com/cgi-bin/XYV/template/LISEXT/1FRAME/index.htm</a>	FILE E 221474
Nominal voltage UN	24 V		
Nominal current IN	4 A		

## Sensor/actuator cable - SAC-3P-MS-M8FR-2L SCO/.../... - 1535710

### Approvals

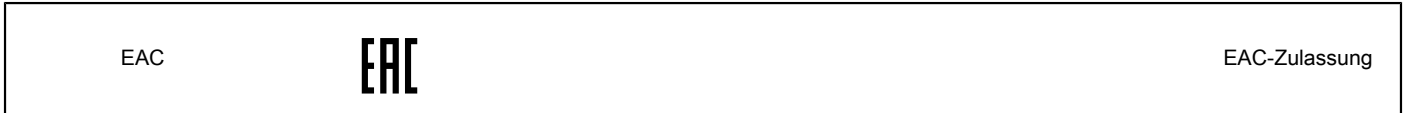

### Accessories

#### Accessories

#### Conductor marking

Insert label - PABA WH/23 - 1013779



Insert label, Strip, white, unlabeled, can be labeled with: CMS-P1-PLOTTER, mounting type: thread on, cable diameter range: 1.5 ... 35 mm, lettering field size: 23 x 4 mm, Number of individual labels: 20

Insert label - PABA YE/23 - 1013782



Insert label, Strip, yellow, unlabeled, can be labeled with: CMS-P1-PLOTTER, mounting type: thread on, cable diameter range: 1.5 ... 35 mm, lettering field size: 23 x 4 mm, Number of individual labels: 20

#### Marker pen

Marker pen - B-STIFT - 1051993



Marker pen, for manual labeling of unprinted Zack strips, smear-proof and waterproof, line thickness 0.5 mm

#### Plug for cable screw gland



## Sensor/actuator cable - SAC-3P-MS-M8FR-2L SCO/.../... - 1535710

### Accessories

Screw plug - PROT-M 8 MS-PA-CHAIN - 1430860

M8 sealing cap made of plastic with fixing band for sensor cables, for M8 sockets



---

### Protective cap

Sealing cap - PROT-M12 FS-PA-CHAIN - 1430873

M12 sealing cap made of plastic with fixing band, for sensor cables, for free M12 plugs



---

### Safety locking

Locking clip - SAC-M12-EXCLIP-M - 1558988



Locking clip for the pin side of sensor/actuator cables with M12 connector and M12 connectors for assembly, for knurl diameter: 15 mm or for Allen key with a wrench size of 14 mm, prevents the disconnection of plug-in connections without tools

---

### Screwdriver tools

Tool - SAC BIT M8-D10 - 1208461



Nut for assembling M8 connectors with longitudinal knurl and a knurl diameter of 10 mm, for 4 mm hexagonal drive

---

Adapter insert - TSD-M SAC-BIT ADAPTER - 1212600



Adapter bit for TSD-M...torque tools, E6.3-1/4" drive with 4 mm hexagon to accommodate SAC bits

## Sensor/actuator cable - SAC-3P-MS-M8FR-2L SCO/.../... - 1535710

### Accessories

Tool - SAC BIT M12-D15 - 1208432



Nut for assembling sensor/actuator cables with M12 connector and M12 connectors for assembly, with a knurl diameter of 15 mm, for 4 mm hexagonal drive

---

### Torque tool

Torque screwdriver - TSD 02 SAC - 1208487



Torque screwdriver, with preset torque of 0.2 Nm and 4 mm hexagonal drive for M8 connectors

---

Torque screwdriver - TSD 04 SAC - 1208429



Torque screwdriver, with preset torque of 0.4 Nm and 4 mm hexagonal drive for M12 connectors

---

Torque screwdriver - TSD-M 1,2NM - 1212224



Torque screw driver, accuracy as per EN ISO 6789 standard, adjustable from 0.3 - 1.2 Nm

---

Phoenix Contact 2020 © - all rights reserved  
<http://www.phoenixcontact.com>

PHOENIX CONTACT GmbH & Co. KG  
Flachsmarktstr. 8  
32825 Blomberg  
Germany  
Tel. +49 5235 300  
Fax +49 5235 3 41200  
<http://www.phoenixcontact.com>