

Bus system cable - SAC-2P-M12MSB/ 5,0-910/M12FSB - 1507382

Please be informed that the data shown in this PDF Document is generated from our Online Catalog. Please find the complete data in the user's documentation. Our General Terms of Use for Downloads are valid (<http://phoenixcontact.com/download>)



Bus system cable, PROFIBUS (12 Mbps), 2-position, PUR halogen-free, violet RAL 4001, shielded, Plug straight M12, coding: B, on Socket straight M12, coding: B, cable length: 5 m



Key Commercial Data

Packing unit	1 pc
GTIN	 4 017918 900205
GTIN	4017918900205

Technical data

Dimensions

Length of cable	5 m
-----------------	-----

Ambient conditions

Ambient temperature (operation)	-25 °C ... 90 °C (Plug / socket)
Degree of protection	IP65
	IP67

General

Note	Further products with variable cable lengths can be found in the accessories section
Rated current at 40°C	4 A
Rated voltage	48 V AC 60 V DC
Number of positions	2
Insulation resistance	≥ 100 MΩ
Coding	B - inverse
Status display	No
Overvoltage category	II
Degree of pollution	3

Bus system cable - SAC-2P-M12MSB/ 5,0-910/M12FSB - 1507382

Technical data

General

Insertion/withdrawal cycles	≥ 100
Torque	0.4 Nm (M12 connector)

Material

Contact material	CuSn
Contact surface material	Ni/Au
Contact carrier material	PA 6.6 (plug), TPU GF (socket)
Material of grip body	TPU, hardly inflammable, self-extinguishing
Material, knurls	Zinc die-cast, nickel-plated
Sealing material	NBR

Cable

Cable type	PROFIBUS
Cable type (abbreviation)	910
UL AWM style	21198 (80°C/300 V)
Cable structure	1x2xAWG24/19
Conductor cross section	2x 0.25 mm ² (Signal line)
AWG signal line	24
Conductor structure signal line	19x 0.13 mm
Core diameter including insulation	2.55 mm ±0.07 mm
Wire colors	Red, green
Overall twist	2 cores with 2 fillers to the core
Shielding	Plastic-coated aluminum foil, tinned copper braided shield
Optical shield covering	85 %
External sheath, color	violet RAL 4001
External cable diameter D	7.8 mm ±0.2 mm
Smallest bending radius, fixed installation	40 mm
Smallest bending radius, movable installation	65 mm
Number of bending cycles	4000000
Bending radius	65 mm
Traversing path	4.5 m
Traversing rate	3 m/s
Acceleration	3 m/s ²
Number of bending cycles	5000000
Bending radius	80 mm
Traversing path	4.5 m
Traversing rate	3 m/s
Acceleration	3 m/s ²
Cable weight	90 kg/km
Outer sheath, material	PUR
Material, filler	PP
Material conductor insulation	Foam-Skin PP

Bus system cable - SAC-2P-M12MSB/ 5,0-910/M12FSB - 1507382

Technical data

Cable

Conductor material	Tin-plated Cu litz wires
Insulation resistance	≥ 5 GΩ*km
Conductor resistance	≤ 78.6 Ω/km
Cable capacity	nom. 30 pF/m
Wave impedance	150 Ω ±10 % (3 MHz ... 20 MHz)
Attenuation	≤ 0.049 dB/m (at 16 MHz)
Nominal voltage, cable	30 V
Test voltage Core/Core	1500 V (50 Hz, 1 min.)
Test voltage Core/Shield	1500 V (50 Hz, 1 min.)
Flame resistance	UL 1581, Sec. 1060 (FT-1)
	IEC 60332-1-2
Halogen-free	in accordance with DIN VDE 0472 part 815
	according to IEC 60754-1
Other resistance	Low adhesion
Ambient temperature (operation)	-40 °C ... 80 °C (cable, fixed installation)
	-30 °C ... 80 °C (cable, flexible installation)
	≤ 70 °C (cable, drag chain applications)

Environmental Product Compliance

China RoHS	Environmentally friendly use period: unlimited = EFUP-e
	No hazardous substances above threshold values

Drawings

Dimensional drawing

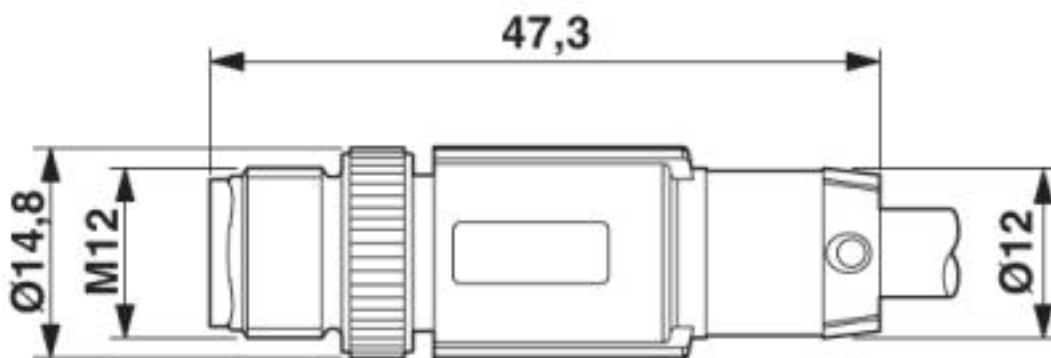

Plug, M12 x 1, straight, shielded

Bus system cable - SAC-2P-M12MSB/ 5,0-910/M12FSB - 1507382

Dimensional drawing

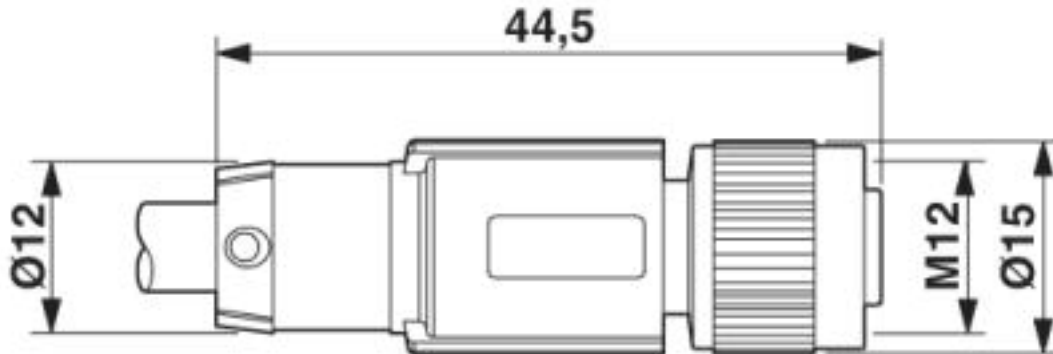

M12 x 1 socket, straight, shielded

Circuit diagram

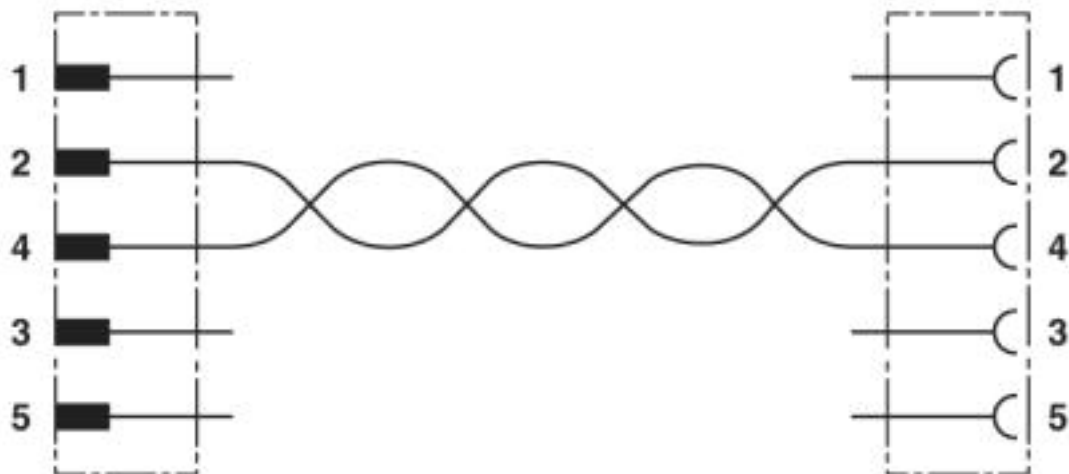

Bus system cable - SAC-2P-M12MSB/ 5,0-910/M12FSB - 1507382

Schematic diagram

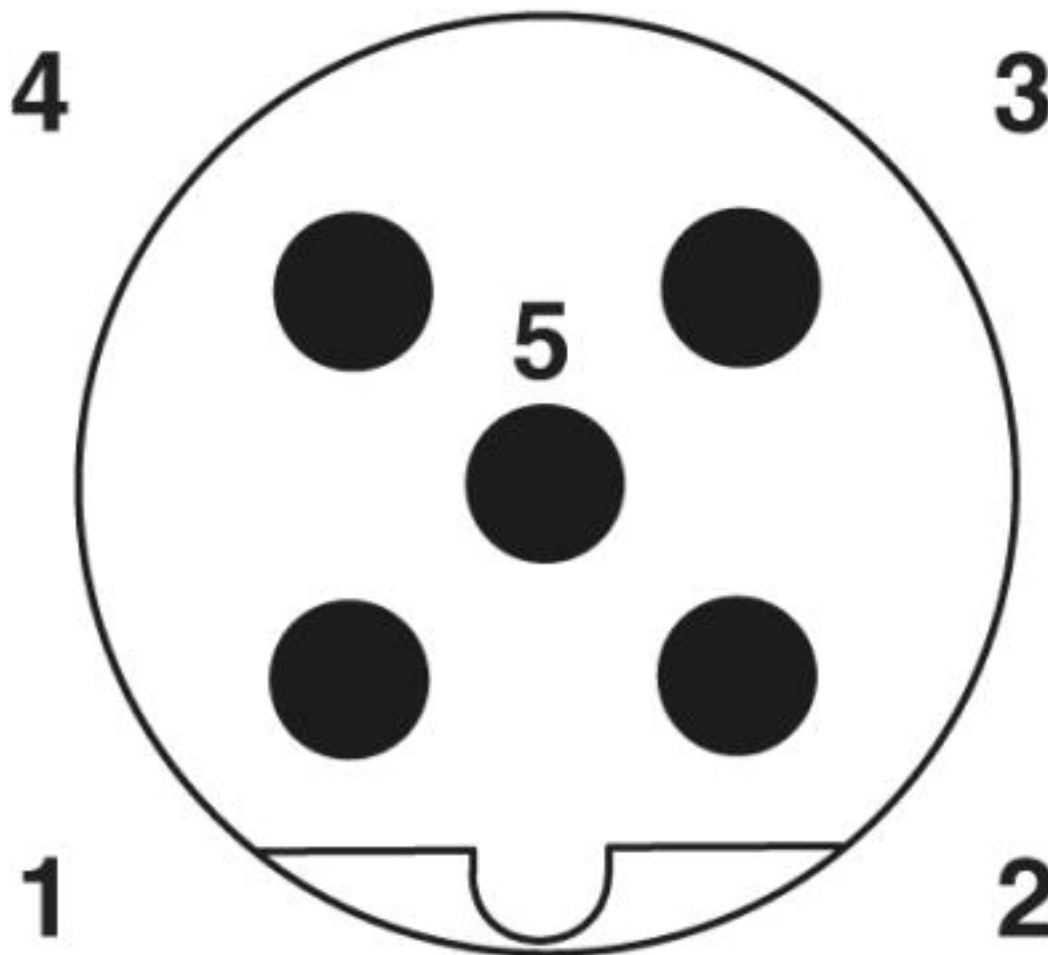

Pin assignment M12 male connector, 5-pos., B-coded, male side

Bus system cable - SAC-2P-M12MSB/ 5,0-910/M12FSB - 1507382

Schematic diagram

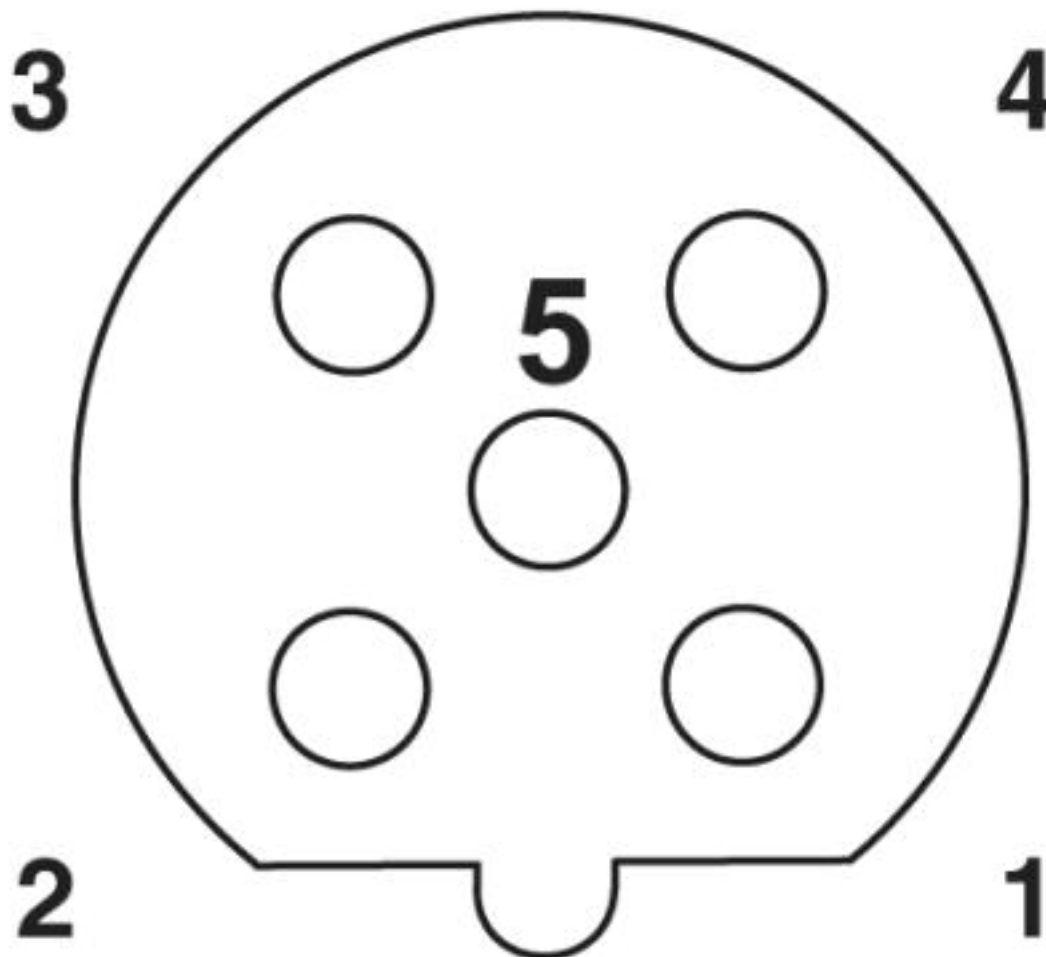

Pin assignment M12 socket, 5-pos., B-coded, female side

Bus system cable - SAC-2P-M12MSB/ 5,0-910/M12FSB - 1507382

Cable cross section

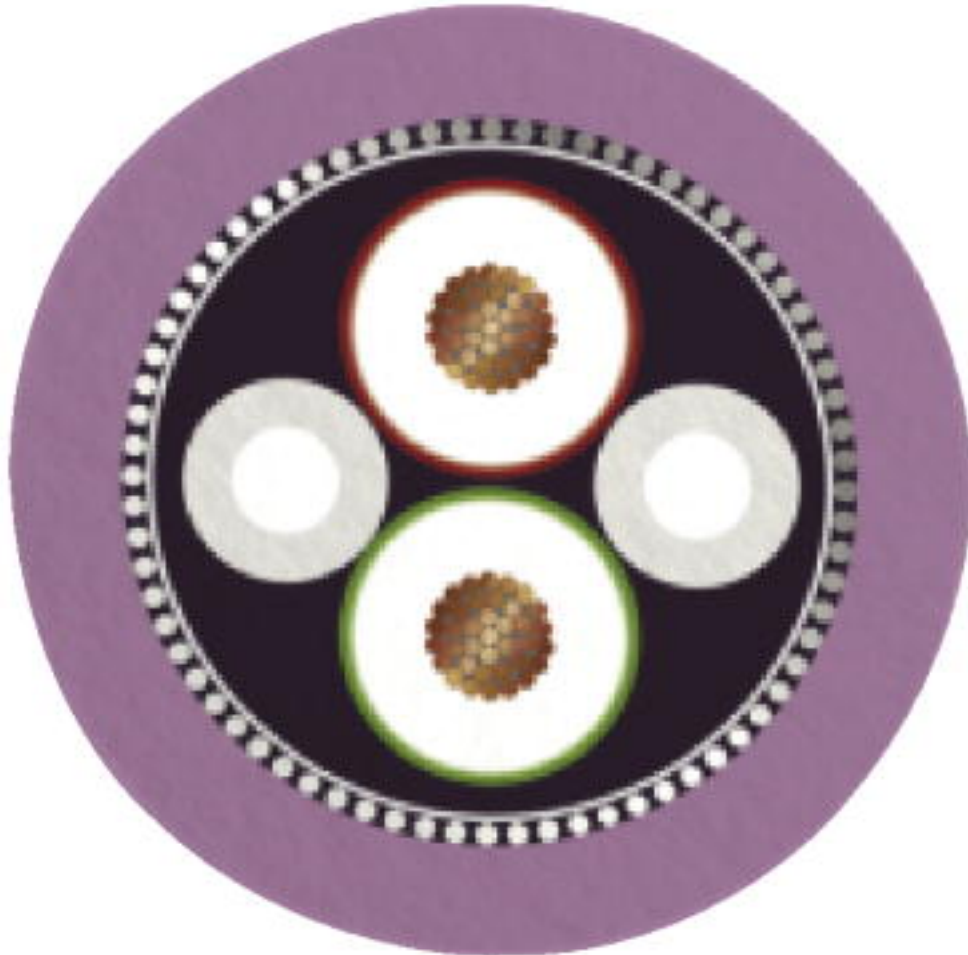

PROFIBUS [910]

Classifications

eCl@ss

eCl@ss 10.0.1	27060308
eCl@ss 4.0	27060300
eCl@ss 4.1	27060300
eCl@ss 5.0	27061800
eCl@ss 5.1	27061800
eCl@ss 6.0	27279200
eCl@ss 7.0	27279218
eCl@ss 8.0	27279218
eCl@ss 9.0	27060308

Bus system cable - SAC-2P-M12MSB/ 5,0-910/M12FSB - 1507382

Classifications

ETIM

ETIM 2.0	EC000830
ETIM 3.0	EC001855
ETIM 4.0	EC001855
ETIM 5.0	EC002599
ETIM 6.0	EC001262
ETIM 7.0	EC001262

UNSPSC

UNSPSC 6.01	31251501
UNSPSC 7.0901	31251501
UNSPSC 11	31251501
UNSPSC 12.01	31251501
UNSPSC 13.2	31251501
UNSPSC 18.0	26121604
UNSPSC 19.0	26121604
UNSPSC 20.0	26121604
UNSPSC 21.0	26121604

Approvals

Approvals

Approvals

null / null / null

Ex Approvals

Approval details

Accessories

Accessories

Data cable preassembled

Bus system cable - SAC-2P-M12MSB/ 5,0-910/M12FSB - 1507382

Accessories

Bus system cable - SAC-2P-M12MSB/910/... - 1538047



Bus system cable, PROFIBUS (12 Mbps), 2-position, PUR halogen-free, violet RAL 4001, shielded, Plug straight M12, coding: B, on free cable end, cable length: Free input (0.2 ... 40.0 m)

Bus system cable - SAC-2P-M12MSB-M12FSB/910/... - 1538089



Bus system cable, PROFIBUS (12 Mbps), 2-position, PUR halogen-free, violet RAL 4001, shielded, Plug straight M12, coding: B, on Socket straight M12, coding: B, cable length: Free input (0.2 ... 40.0 m)

Bus system cable - SAC-2P-M12FSB/910/... - 1538063



Bus system cable, PROFIBUS (12 Mbps), 2-position, PUR halogen-free, violet RAL 4001, shielded, free cable end, on Socket straight M12, coding: B, cable length: Free input (0.2 ... 40.0 m)

Plug for cable screw gland

Screw plug - PROT-M12 MS-PA-CHAIN - 1430899

M12 sealing cap with fixing band, for sensor cables, for free M12 sockets



Protective cap

Sealing cap - PROT-M12 FS-PA-CHAIN - 1430873

M12 sealing cap made of plastic with fixing band, for sensor cables, for free M12 plugs



Safety locking

Bus system cable - SAC-2P-M12MSB/ 5,0-910/M12FSB - 1507382

Accessories

Locking clip - SAC-M12-EXCLIP-M - 1558988



Locking clip for the pin side of sensor/actuator cables with M12 connector and M12 connectors for assembly, for knurl diameter: 15 mm or for Allen key with a wrench size of 14 mm, prevents the disconnection of plug-in connections without tools

Locking clip - SAC-M12-EXCLIP-F - 1558991



Locking clip for the socket side of sensor/actuator cables with M12 connector and M12 connectors for assembly, for knurl diameter: 15 mm or for Allen key with a wrench size of 14 mm, prevents the disconnection of plug-in connections without tools

Screwdriver tools

Adapter insert - TSD-M SAC-BIT ADAPTER - 1212600



Adapter bit for TSD-M...torque tools, E6.3-1/4" drive with 4 mm hexagon to accommodate SAC bits

Tool - SAC BIT M12-D15 - 1208432



Nut for assembling sensor/actuator cables with M12 connector and M12 connectors for assembly, with a knurl diameter of 15 mm, for 4 mm hexagonal drive

T-distributor

T distributor - SAC-5PT-FB/2XMB PBDP SH - 1424711



T distributor, PROFIBUS DP (12 Mbps), 5-position, shielded, Socket straight M12, coding: B, on Plug straight M12, coding: B and Plug straight M12, coding: B

Bus system cable - SAC-2P-M12MSB/ 5,0-910/M12FSB - 1507382

Accessories

T distributor - SAC-5PT-FB/MB-MBF PBDP SH - 1424713



T distributor, PROFIBUS DP (12 Mbps), 5-position, shielded, Socket straight M12, coding: B, on Plug straight M12, coding: B and Plug straight M12, coding: B, Thread M12 plug input not rotatable

Terminal resistor

Termination resistor - SAC-5P-M12MS PB TR - 1507803



Terminating resistor PROFIBUS M12

Torque tool

Torque screwdriver - TSD 04 SAC - 1208429



Torque screwdriver, with preset torque of 0.4 Nm and 4 mm hexagonal drive for M12 connectors

Torque screwdriver - TSD-M 1,2NM - 1212224



Torque screw driver, accuracy as per EN ISO 6789 standard, adjustable from 0.3 - 1.2 Nm