

# Sensor/actuator cable - SAC-5P-M12MS/ 1,5-PUR/M12FS SH - 1500907

Please be informed that the data shown in this PDF Document is generated from our Online Catalog. Please find the complete data in the user's documentation. Our General Terms of Use for Downloads are valid (<http://phoenixcontact.com/download>)



Sensor/actuator cable, 5-position, PUR halogen-free, black-gray RAL 7021, shielded, Plug straight M12, coding: A, on Socket straight M12, coding: A, cable length: 1.5 m

## Your advantages

- ✓ Easy and safe: 100% electrically tested plug-in components
- ✓ Our standard: robust halogen-free PUR cable
- ✓ Reliable signal transmission – 360° shielding in environments with electromagnetic interference

## Key Commercial Data

|              |   |
|--------------|---|
| Packing unit | 1 pc  |
| GTIN         | <br>4 017918 618155 |
| GTIN         | 4017918618155   |

## Technical data

### Dimensions

|                 |       |
|-----------------|-------|
| Length of cable | 1.5 m |
|-----------------|-------|

### Ambient conditions

|                                 |                                  |
|---------------------------------|----------------------------------|
| Ambient temperature (operation) | -25 °C ... 90 °C (Plug / socket) |
| Degree of protection            | IP65                             |
|                                 | IP67                             |

### General

|                       |              |
|-----------------------|--------------|
| Rated current at 40°C | 4 A          |
| Rated voltage         | 48 V AC      |
|                       | 60 V DC      |
| Number of positions   | 5            |
| Insulation resistance | ≥ 100 MΩ     |
| Coding                | A - standard |

# Sensor/actuator cable - SAC-5P-M12MS/ 1,5-PUR/M12FS SH - 1500907

## Technical data

### General

|                              |                               |
|------------------------------|-------------------------------|
| Standards/regulations        | M12 connector IEC 61076-2-101 |
| Status display               | No                            |
| Protective circuit/component | unwired                       |
| Overvoltage category         | II                            |
| Degree of pollution          | 3                             |
| Insertion/withdrawal cycles  | ≥ 100                         |
| Torque                       | 0.4 Nm (M12 connector)        |

### Material

|  |   |
|--|---|
| Flammability rating according to UL 94 | HB  |
| Contact material                       | CuSn  |
| Contact surface material               | Ni/Au                                       |
| Contact carrier material               | TPU GF                                      |
| Material of grip body                  | TPU, hardly inflammable, self-extinguishing |
| Material, knurls                       | Zinc die-cast, nickel-plated                |
| Sealing material                       | NBR   |

### Standards and Regulations

|  |                               |
|--|-------------------------------|
| Standards/specifications               | M12 connector IEC 61076-2-101 |
| Flammability rating according to UL 94 | HB                            |

### Cable

|   |                                       |
|---|---------------------------------------|
| Cable type                                    | PUR halogen-free black                |
| Cable type (abbreviation)                     | PUR                                   |
| Cable abbreviation                            | LiF9YC11Y                             |
| UL AWM style                                  | 20549 / 10493 (80°C/300 V)            |
| Conductor cross section                       | 5x 0.34 mm <sup>2</sup> (Signal line) |
| AWG signal line                               | 22                                    |
| Conductor structure signal line               | 42x 0.10 mm                           |
| Core diameter including insulation            | 1.27 mm ±0.02 mm (Signal line)        |
| Thickness, insulation                         | ≥ 0.21 mm                             |
| Wire colors                                   | Brown, white, blue, black, gray       |
| Overall twist                                 | 5 wires around filler to the core     |
| Shielding                                     | Tinned copper braided shield          |
| Optical shield covering                       | 80 %                                  |
| External sheath, color                        | black-gray RAL 7021                   |
| Outer sheath thickness                        | approx. 0.5 mm                        |
| External cable diameter D                     | 5.25 mm ±0.2 mm                       |
| Smallest bending radius, fixed installation   | 26 mm                                 |
| Smallest bending radius, movable installation | 52 mm (up to +60°C)                   |
| Number of bending cycles                      | 10000000                              |
| Bending radius                                | 52 mm                                 |

# Sensor/actuator cable - SAC-5P-M12MS/ 1,5-PUR/M12FS SH - 1500907

## Technical data

### Cable

|                                 |   |
|---------------------------------|---|
| Traversing path                 | 10 m  |
| Traversing rate                 | 3 m/s   |
| Acceleration                    | 10 m/s <sup>2</sup>   |
| Cable weight                    | 43 kg/km  |
| Outer sheath, material          | PUR   |
| Material conductor insulation   | PP  |
| Conductor material              | Bare Cu litz wires  |
| Insulation resistance           | 70 GΩ*km (at 20 °C)   |
| Conductor resistance            | max. 57 Ω/km (at 20 °C)   |
| Nominal voltage, cable          | 300 V (at 20 °C)  |
| Test voltage Core/Core          | 3000 V (at 20 °C)   |
| Special properties              | Flexible cable conduit capable                                      |
|                                 | Silicone-free   |
|                                 | Free of substances which would hinder coating with paint or varnish |
|                                 | Low adhesion surface  |
| Flame resistance                | in accordance with UL 758/1581 FT2                                  |
|                                 | DIN EN 60332-2-2 (20 s)   |
| Halogen-free                    | in accordance with DIN VDE 0472 part 815                            |
|                                 | in accordance with DIN EN 50267-2-1                                 |
| Resistance to oil               | in accordance with DIN EN 60811-2-1                                 |
| Other resistance                | Highly resistant to acids, alkaline solutions and solvents          |
|                                 | hydrolysis and microbe resistant                                    |
|                                 | Resistant to salt water   |
|                                 | partly UV-resistant in accordance with DIN EN ISO 4892-2-A          |
|                                 | abrasion-resistant  |
| Ambient temperature (operation) | -40 °C ... 80 °C (cable, fixed installation)                        |
|                                 | -25 °C ... 80 °C (cable, flexible installation)                     |

### Environmental Product Compliance

|            |   |
|------------|---|
| China RoHS | Environmentally friendly use period: unlimited = EFUP-e |
|            | No hazardous substances above threshold values          |

### Drawings

# Sensor/actuator cable - SAC-5P-M12MS/ 1,5-PUR/M12FS SH - 1500907

Dimensional drawing

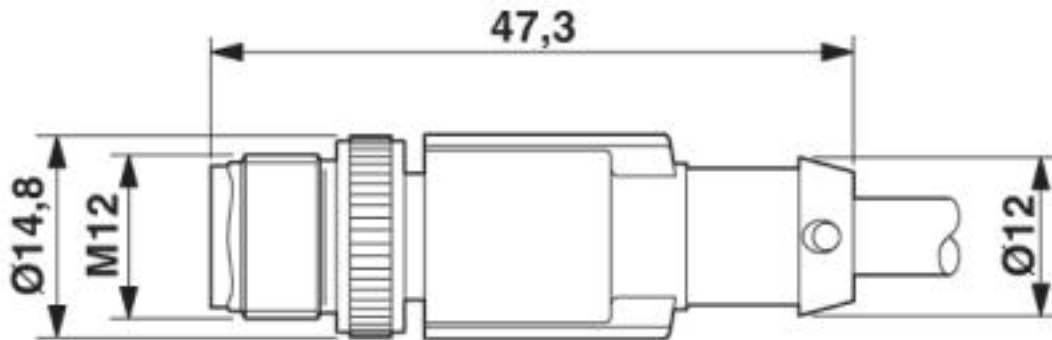

Plug, M12 x 1, straight, shielded

Dimensional drawing

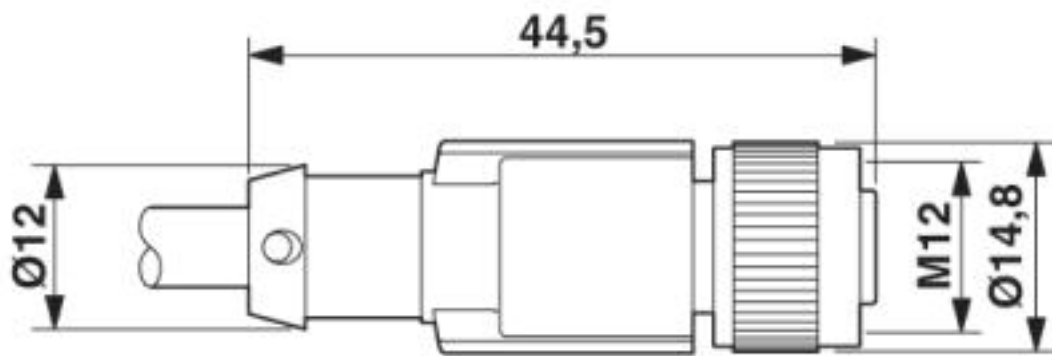

M12 x 1 socket, straight, shielded

# Sensor/actuator cable - SAC-5P-M12MS/ 1,5-PUR/M12FS SH - 1500907

Circuit diagram

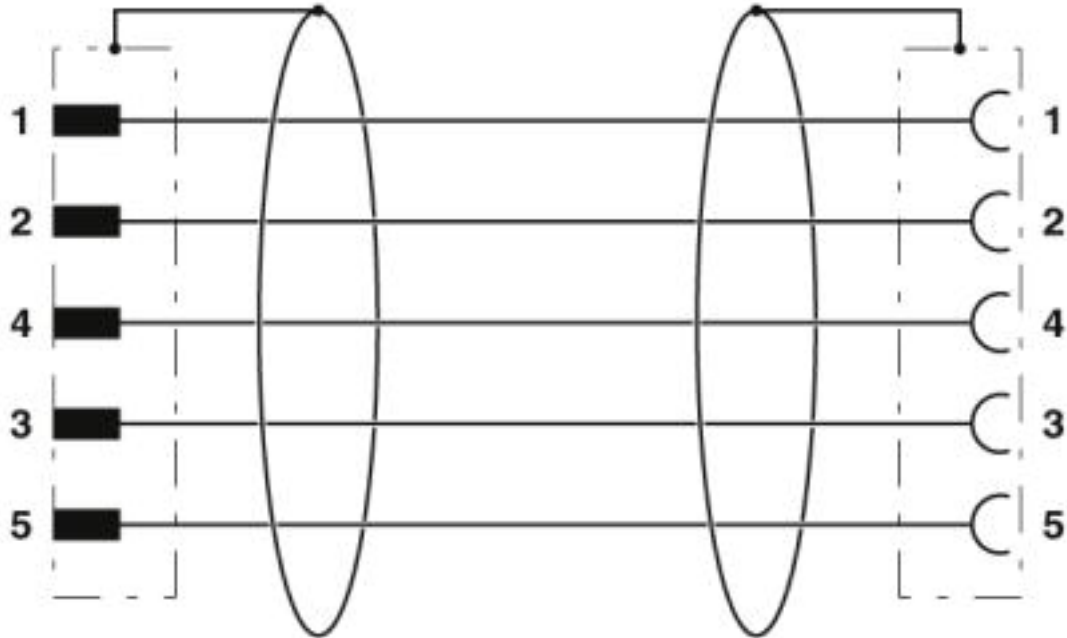

Contact assignment of the M12 plug and the M12 socket

# Sensor/actuator cable - SAC-5P-M12MS/ 1,5-PUR/M12FS SH - 1500907

Schematic diagram

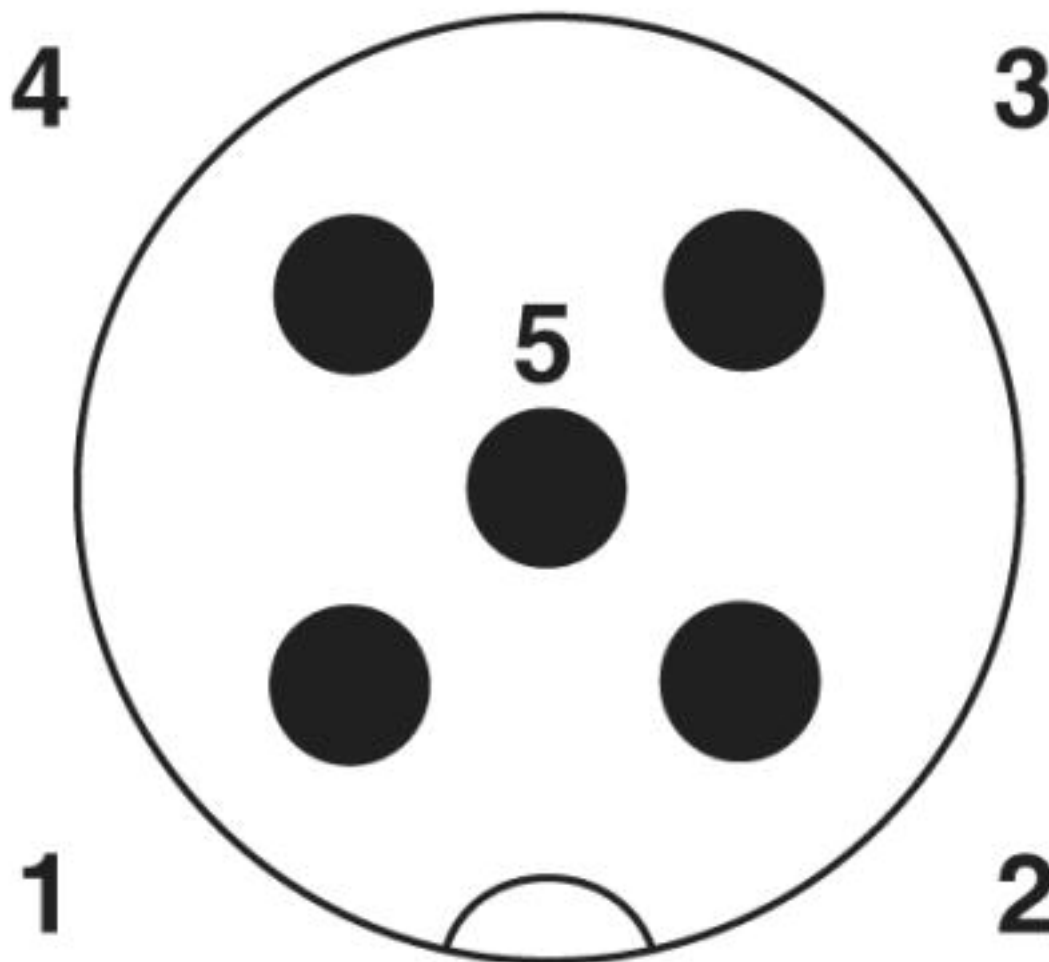

Pin assignment M12 male connector, 5-pos., A-coded, male side

# Sensor/actuator cable - SAC-5P-M12MS/ 1,5-PUR/M12FS SH - 1500907

Schematic diagram

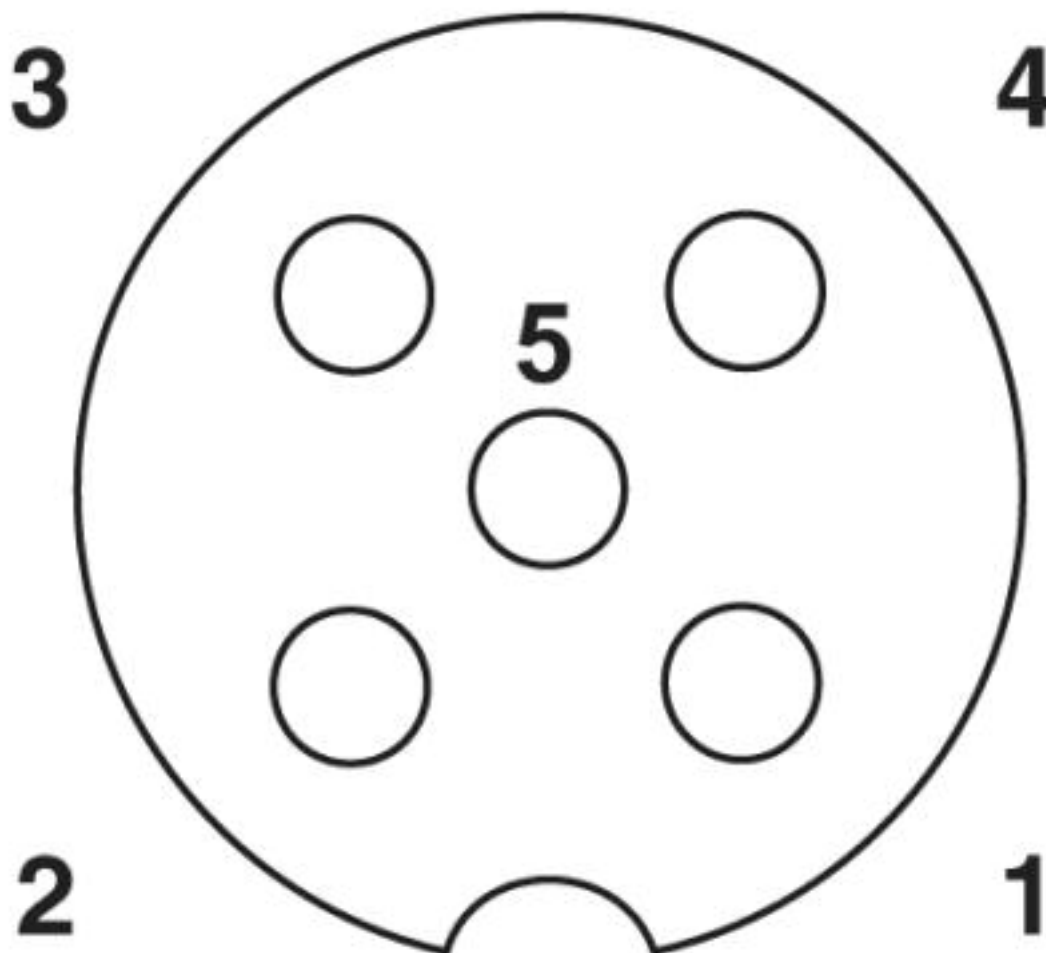

Pin assignment M12 socket, 5-pos., A-coded, socket side view

# Sensor/actuator cable - SAC-5P-M12MS/ 1,5-PUR/M12FS SH - 1500907

Cable cross section



PUR halogen-free black [PUR]

## Classifications

eCl@ss

|               |          |
|---------------|----------|
| eCl@ss 10.0.1 | 27060311 |
| eCl@ss 4.0    | 27060300 |
| eCl@ss 4.1    | 27060300 |
| eCl@ss 5.0    | 27061800 |
| eCl@ss 5.1    | 27061800 |
| eCl@ss 6.0    | 27279200 |
| eCl@ss 7.0    | 27279218 |
| eCl@ss 8.0    | 27279218 |
| eCl@ss 9.0    | 27060311 |



# Sensor/actuator cable - SAC-5P-M12MS/ 1,5-PUR/M12FS SH - 1500907

## Classifications

### ETIM

|          |          |
|----------|----------|
| ETIM 2.0 | EC000830 |
| ETIM 3.0 | EC001855 |
| ETIM 4.0 | EC001855 |
| ETIM 5.0 | EC001855 |
| ETIM 6.0 | EC001855 |
| ETIM 7.0 | EC001855 |

### UNSPSC

|               |          |
|---------------|----------|
| UNSPSC 6.01   | 31251501 |
| UNSPSC 7.0901 | 31251501 |
| UNSPSC 11     | 31251501 |
| UNSPSC 12.01  | 31251501 |
| UNSPSC 13.2   | 31251501 |
| UNSPSC 19.0   | 31251501 |
| UNSPSC 20.0   | 31251501 |
| UNSPSC 21.0   | 31251501 |

## Approvals

### Approvals

#### Approvals

UL Listed / cUL Listed / cULus Listed

#### Ex Approvals

### Approval details

|                    |   |   |               |
|--------------------|---|---|---------------|
| UL Listed          |  | <a href="http://database.ul.com/cgi-bin/XYV/template/LISEXT/1FRAME/index.htm">http://database.ul.com/cgi-bin/XYV/template/LISEXT/1FRAME/index.htm</a> | FILE E 221474 |
| Nominal voltage UN | 125 V   |   |               |
| Nominal current IN | 4 A   |   |               |

|                    |   |   |               |
|--------------------|---|---|---------------|
| cUL Listed         |  | <a href="http://database.ul.com/cgi-bin/XYV/template/LISEXT/1FRAME/index.htm">http://database.ul.com/cgi-bin/XYV/template/LISEXT/1FRAME/index.htm</a> | FILE E 221474 |
| Nominal voltage UN | 125 V   |   |               |

# Sensor/actuator cable - SAC-5P-M12MS/ 1,5-PUR/M12FS SH - 1500907

## Approvals

|                                |     |
|--------------------------------|-----|
| Nominal current I <sub>N</sub> | 4 A |
|--------------------------------|-----|

|              |  |
|--------------|--|
| cULus Listed |  |
|--------------|--|

## Accessories

### Accessories

#### Conductor marking

Insert label - PABA WH/23 - 1013779



Insert label, Strip, white, unlabeled, can be labeled with: CMS-P1-PLOTTER, mounting type: thread on, cable diameter range: 1.5 ... 35 mm, lettering field size: 23 x 4 mm, Number of individual labels: 20

Insert label - PABA YE/23 - 1013782



Insert label, Strip, yellow, unlabeled, can be labeled with: CMS-P1-PLOTTER, mounting type: thread on, cable diameter range: 1.5 ... 35 mm, lettering field size: 23 x 4 mm, Number of individual labels: 20

#### Marker pen

Marker pen - B-STIFT - 1051993



Marker pen, for manual labeling of unprinted Zack strips, smear-proof and waterproof, line thickness 0.5 mm

#### Plug for cable screw gland

Screw plug - PROT-M12 MS-PA-CHAIN - 1430899

M12 sealing cap with fixing band, for sensor cables, for free M12 sockets



## Sensor/actuator cable - SAC-5P-M12MS/ 1,5-PUR/M12FS SH - 1500907

### Accessories

#### Protective cap

Sealing cap - PROT-M12 FS-PA-CHAIN - 1430873

M12 sealing cap made of plastic with fixing band, for sensor cables, for free M12 plugs



#### Safety locking

Locking clip - SAC-M12-EXCLIP-M - 1558988



Locking clip for the pin side of sensor/actuator cables with M12 connector and M12 connectors for assembly, for knurl diameter: 15 mm or for Allen key with a wrench size of 14 mm, prevents the disconnection of plug-in connections without tools

Locking clip - SAC-M12-EXCLIP-F - 1558991



Locking clip for the socket side of sensor/actuator cables with M12 connector and M12 connectors for assembly, for knurl diameter: 15 mm or for Allen key with a wrench size of 14 mm, prevents the disconnection of plug-in connections without tools

#### Screwdriver tools

Adapter insert - TSD-M SAC-BIT ADAPTER - 1212600



Adapter bit for TSD-M...torque tools, E6.3-1/4" drive with 4 mm hexagon to accommodate SAC bits

Tool - SAC BIT M12-D15 - 1208432



Nut for assembling sensor/actuator cables with M12 connector and M12 connectors for assembly, with a knurl diameter of 15 mm, for 4 mm hexagonal drive

#### Torque tool

## Sensor/actuator cable - SAC-5P-M12MS/ 1,5-PUR/M12FS SH - 1500907

### Accessories

Torque screwdriver - TSD 04 SAC - 1208429



Torque screwdriver, with preset torque of 0.4 Nm and 4 mm hexagonal drive for M12 connectors

---

Torque screwdriver - TSD-M 1,2NM - 1212224



Torque screw driver, accuracy as per EN ISO 6789 standard, adjustable from 0.3 - 1.2 Nm

---

---

Phoenix Contact 2020 © - all rights reserved  
<http://www.phoenixcontact.com>

PHOENIX CONTACT GmbH & Co. KG  
Flachsmarktstr. 8  
32825 Blomberg  
Germany  
Tel. +49 5235 300  
Fax +49 5235 3 41200  
<http://www.phoenixcontact.com>