

Sensor/actuator cable - SAC-5P-MS/ 5,0-547/FR SCO BK - 1424985

Please be informed that the data shown in this PDF Document is generated from our Online Catalog. Please find the complete data in the user's documentation. Our General Terms of Use for Downloads are valid (<http://phoenixcontact.com/download>)



Sensor/actuator cable, 5-position, PVC, yellow, Plug straight M12 SPEEDCON, coding: A, on Socket angled M12 SPEEDCON, coding: A, cable length: 5 m



Key Commercial Data

Packing unit	1 pc
GTIN	 4 0 5 5 6 2 6 4 0 2 3 2 1
GTIN	4055626402321

Technical data

Dimensions

Length of cable	5 m
-----------------	-----

Ambient conditions

Ambient temperature (operation)	-25 °C ... 90 °C (Plug / socket)
Degree of protection	IP65
	IP67
	IP68

General

Rated current at 40°C	4 A
Rated voltage	48 V AC
	60 V DC
Number of positions	5
Insulation resistance	≥ 10 MΩ
Coding	A - standard
Standards/regulations	M12 connector IEC 61076-2-101
Status display	No
Protective circuit/component	unwired
Overvoltage category	II

Sensor/actuator cable - SAC-5P-MS/ 5,0-547/FR SCO BK - 1424985

Technical data

General

Degree of pollution	3
Torque	0.4 Nm (M12 connector)

Material

Flammability rating according to UL 94	HB
Contact material	CuSn
Contact surface material	Ni/Au
Contact carrier material	TPU GF
Material of grip body	TPU, hardly inflammable, self-extinguishing
Material, knurls	Zinc die-cast, nickel-plated
Sealing material	NBR

Standards and Regulations

Standards/specifications	M12 connector IEC 61076-2-101
Flammability rating according to UL 94	HB

Cable

Cable type	PVC yellow 105 °C
Cable type (abbreviation)	547
UL AWM style	2517 (105 °C / 300 V)
AWG signal line	18
Conductor structure signal line	41x 0.16 mm
Core diameter including insulation	1.7 mm ±0.03 mm
Wire colors	Brown, white, blue, black, gray
Overall twist	5 wires around filler to the core
External sheath, color	yellow
External cable diameter D	6.6 mm ±0.2 mm
Minimum bending radius, fixed installation	8 x D
Outer sheath, material	PVC
Material, filler	PP
Material conductor insulation	PVC
Conductor material	Tin-plated Cu litz wires
Nominal voltage, cable	300 V
Special properties	C(UL) CMX OUTDOOR-CMG 105 °C
	UL ITC/PLTC 105 °C
	CSA AWM I/II A/B FT4 105 °C / 300 V
Flame resistance	FT4
Ambient temperature (operation)	-30 °C ... 105 °C (cable, fixed installation)

Environmental Product Compliance

China RoHS	Environmentally Friendly Use Period = 50 years
	For details about hazardous substances go to tab "Downloads", Category "Manufacturer's declaration"

Sensor/actuator cable - SAC-5P-MS/ 5,0-547/FR SCO BK - 1424985

Drawings

Dimensional drawing

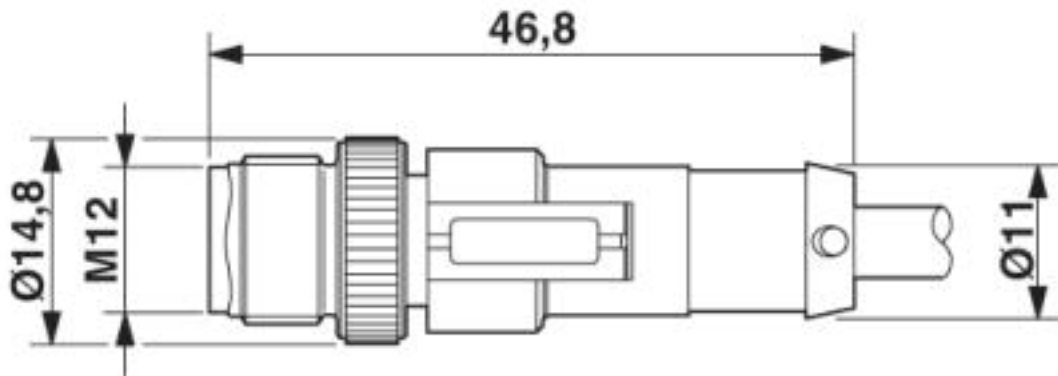

Plug, M12 x 1, straight, shielded

Dimensional drawing

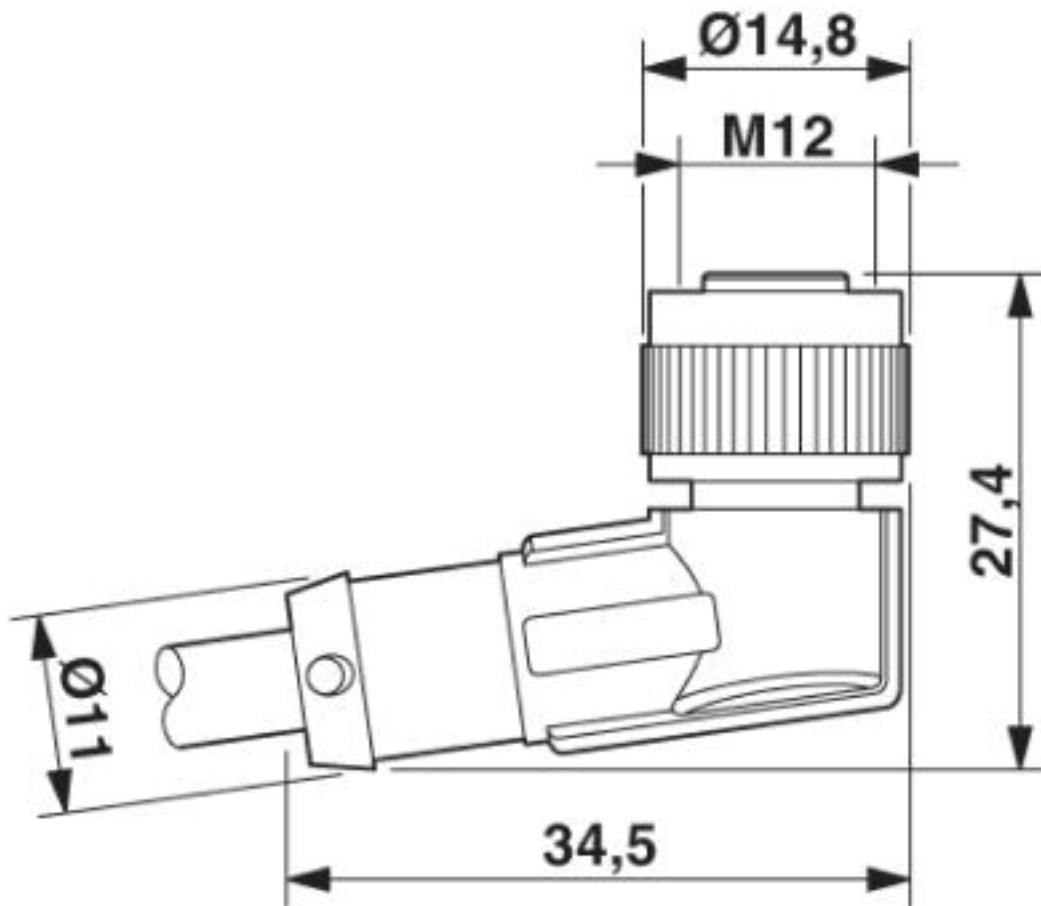

M12 x 1 socket, angled

Sensor/actuator cable - SAC-5P-MS/ 5,0-547/FR SCO BK - 1424985

Circuit diagram



Contact assignment of the M12 plug and the M12 socket

Sensor/actuator cable - SAC-5P-MS/ 5,0-547/FR SCO BK - 1424985

Schematic diagram

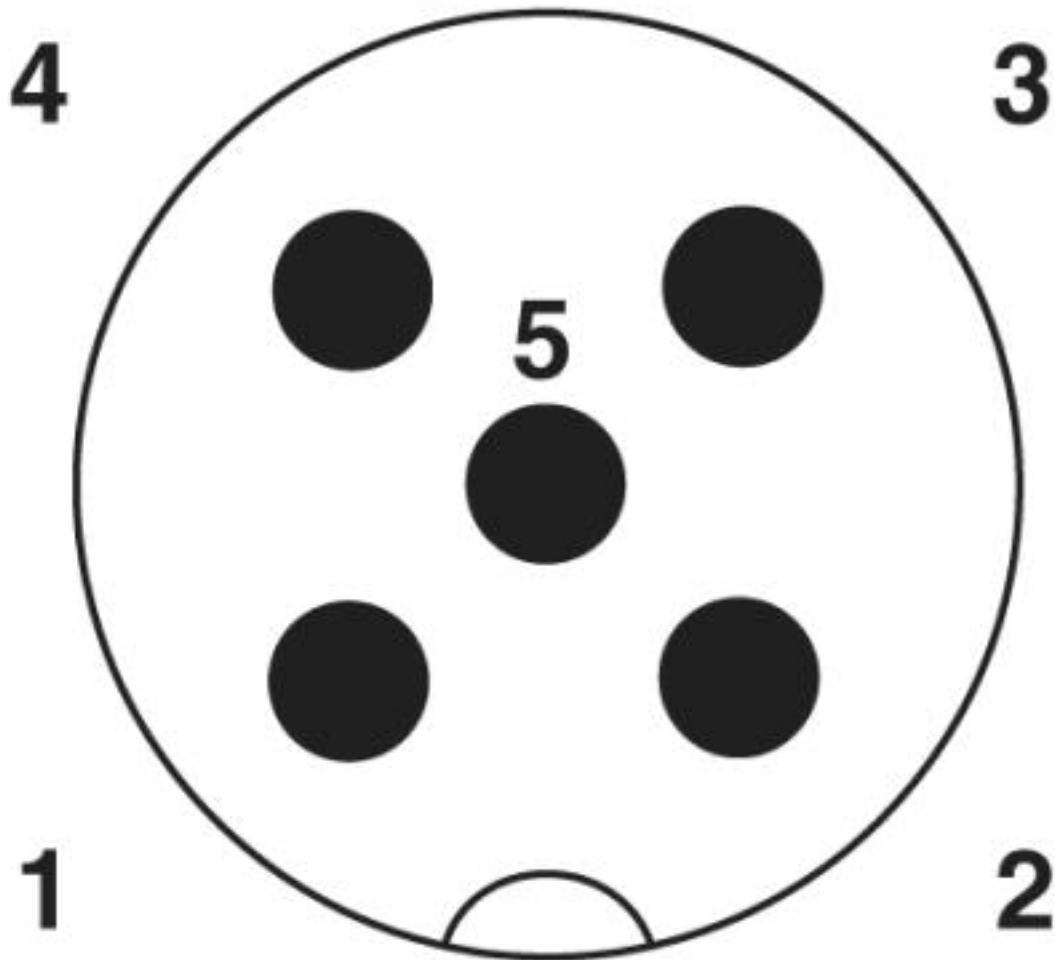

Pin assignment M12 male connector, 5-pos., A-coded, male side

Sensor/actuator cable - SAC-5P-MS/ 5,0-547/FR SCO BK - 1424985

Schematic diagram

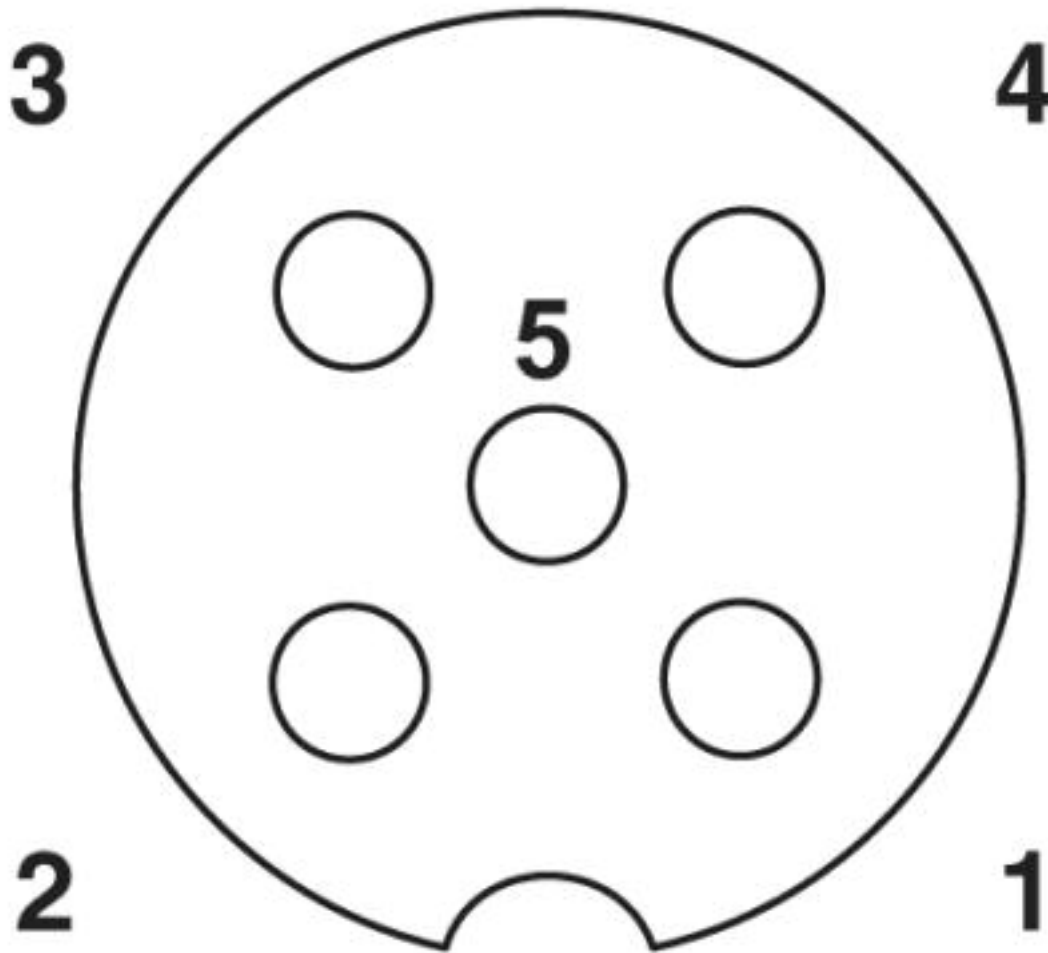

Pin assignment M12 socket, 5-pos., A-coded, female side

Sensor/actuator cable - SAC-5P-MS/ 5,0-547/FR SCO BK - 1424985

Cable cross section

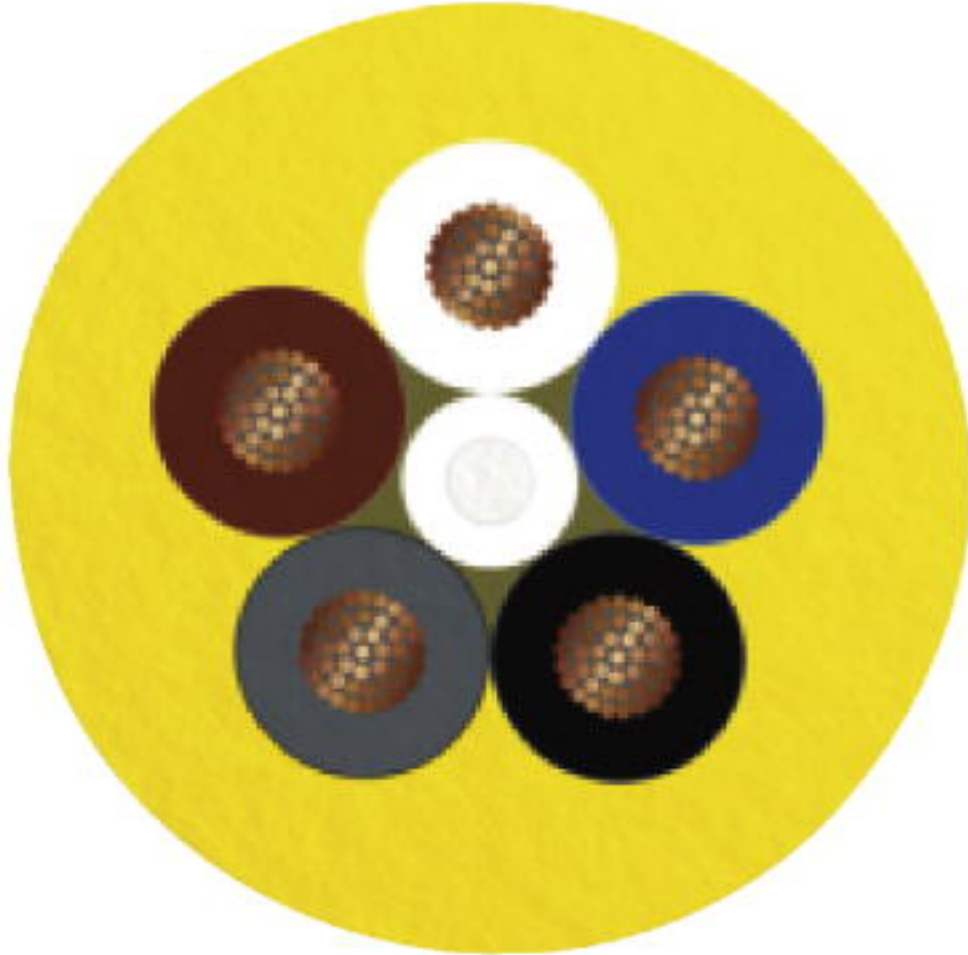

PVC yellow 105 °C [547]

Classifications

eCl@ss

eCl@ss 10.0.1	27060311
eCl@ss 4.0	27060306
eCl@ss 4.1	27060306
eCl@ss 5.0	27061801
eCl@ss 5.1	27061801
eCl@ss 6.0	27279200
eCl@ss 7.0	27279218
eCl@ss 8.0	27279218
eCl@ss 9.0	27060311

Sensor/actuator cable - SAC-5P-MS/ 5,0-547/FR SCO BK - 1424985

Classifications

ETIM

ETIM 2.0	EC000830
ETIM 3.0	EC001855
ETIM 4.0	EC001855
ETIM 5.0	EC001855
ETIM 6.0	EC001855
ETIM 7.0	EC001855

UNSPSC

UNSPSC 6.01	31251501
UNSPSC 7.0901	31251501
UNSPSC 11	31251501
UNSPSC 12.01	31251501
UNSPSC 13.2	31251501
UNSPSC 19.0	31251501
UNSPSC 20.0	31251501
UNSPSC 21.0	31251501

Approvals

Approvals

Approvals

UL Listed / cUL Listed / EAC / cULus Listed

Ex Approvals

Approval details

UL Listed		http://database.ul.com/cgi-bin/XYV/template/LISEXT/1FRAME/index.htm	FILE E 221474
Nominal voltage UN	125 V		
Nominal current IN	4 A		

cUL Listed		http://database.ul.com/cgi-bin/XYV/template/LISEXT/1FRAME/index.htm	FILE E 221474
Nominal voltage UN	125 V		

Sensor/actuator cable - SAC-5P-MS/ 5,0-547/FR SCO BK - 1424985

Approvals

Nominal current I _N	4 A
--------------------------------	-----

EAC		RU D- DE.HB35.B.00387
-----	--	--------------------------

cULus Listed	
--------------	--

Accessories

Accessories

Plug for cable screw gland

Screw plug - PROT-M12 MS-PA-CHAIN - 1430899

M12 sealing cap with fixing band, for sensor cables, for free M12 sockets



Protective cap

Sealing cap - PROT-M12 FS-PA-CHAIN - 1430873

M12 sealing cap made of plastic with fixing band, for sensor cables, for free M12 plugs



Safety locking

Locking clip - SAC-M12-EXCLIP-M - 1558988

Locking clip for the pin side of sensor/actuator cables with M12 connector and M12 connectors for assembly, for knurl diameter: 15 mm or for Allen key with a wrench size of 14 mm, prevents the disconnection of plug-in connections without tools



Sensor/actuator cable - SAC-5P-MS/ 5,0-547/FR SCO BK - 1424985

Accessories

Locking clip - SAC-M12-EXCLIP-F - 1558991



Locking clip for the socket side of sensor/actuator cables with M12 connector and M12 connectors for assembly, for knurl diameter: 15 mm or for Allen key with a wrench size of 14 mm, prevents the disconnection of plug-in connections without tools

Screwdriver tools

Adapter insert - TSD-M SAC-BIT ADAPTER - 1212600



Adapter bit for TSD-M...torque tools, E6.3-1/4" drive with 4 mm hexagon to accommodate SAC bits

Tool - SAC BIT M12-D15 - 1208432



Nut for assembling sensor/actuator cables with M12 connector and M12 connectors for assembly, with a knurl diameter of 15 mm, for 4 mm hexagonal drive

Torque tool

Torque screwdriver - TSD 04 SAC - 1208429



Torque screwdriver, with preset torque of 0.4 Nm and 4 mm hexagonal drive for M12 connectors

Torque screwdriver - TSD-M 1,2NM - 1212224



Torque screw driver, accuracy as per EN ISO 6789 standard, adjustable from 0.3 - 1.2 Nm

Phoenix Contact 2020 © - all rights reserved
<http://www.phoenixcontact.com>

PHOENIX CONTACT GmbH & Co. KG
Flachsmarktstr. 8
32825 Blomberg
Germany
Tel. +49 5235 300
Fax +49 5235 3 41200
<http://www.phoenixcontact.com>