

Power cable - SAC-3P-M12MRS/ 5,0-PVC PE - 1411642

Please be informed that the data shown in this PDF Document is generated from our Online Catalog. Please find the complete data in the user's documentation. Our General Terms of Use for Downloads are valid (<http://phoenixcontact.com/download>)



Power cable, 3-position, PVC, black, Plug angled M12, coding: S, on free cable end, cable length: 5 m, for AC current up to 16 A/230 V

Your advantages

- ✓ Easy and safe: 100% electrically tested plug-in components
- ✓ High-performance: AC connectors for up to 16 A and 230 V AC
- ✓ Protection against incorrect connection using special S-coding

RoHS

Key Commercial Data

Packing unit	1 pc
GTIN	 4 046356 937467
GTIN	4046356937467

Technical data

Dimensions

Length of cable	5 m
-----------------	-----

Ambient conditions

Ambient temperature (operation)	-25 °C ... 85 °C (Plug / socket)
Degree of protection	IP65
	IP67

General

Rated current at 40°C	16 A
Rated voltage	230 V AC
	230 V DC
Number of positions	3
Color handle area	black
Insulation resistance	≥ 100 MΩ

Power cable - SAC-3P-M12MRS/ 5,0-PVC PE - 1411642

Technical data

General

Coding	S power
Standards/regulations	M12 connector IEC 61076-2-111
Status display	No
Protective circuit/component	unwired
Overvoltage category	III
Degree of pollution	3
Insertion/withdrawal cycles	> 100
Torque	0.4 Nm (M12 connector)

Material

Flammability rating according to UL 94	V0
Contact material	CuZn
Contact surface material	Ni/Au
Contact carrier material	PA
Material of grip body	PP
Material, knurls	Zinc die-cast, nickel-plated

Standards and Regulations

Standards/specifications	M12 connector IEC 61076-2-111
Flammability rating according to UL 94	V0

Cable

Cable type	PVC black
Cable type (abbreviation)	PVC
Cable abbreviation	LSYwYw-JZ
UL AWM style	2517 (105 °C / 300 V)
Conductor cross section	3x 1.5 mm ²
AWG power supply	16
Conductor structure, voltage supply	30x 0.25 mm
Core diameter including insulation	2.4 mm ±0.1 mm
Wire colors	black 1, black 2, green/yellow
Overall twist	3 wires, twisted
External sheath, color	black
External cable diameter D	6.8 mm ±0.2 mm
Minimum bending radius, fixed installation	5 x D
Minimum bending radius, flexible installation	12 x D
Cable weight	80 kg/km
Outer sheath, material	PVC
Material conductor insulation	PVC
Conductor material	Bare Cu litz wires
Insulation resistance	≥ 10 MΩ*km (at 20 °C)
Conductor resistance	≤ 13.3 Ω/km (at 20 °C)

Power cable - SAC-3P-M12MRS/ 5,0-PVC PE - 1411642

Technical data

Cable

Nominal voltage, cable	300 V AC
Test voltage, cable	2000 V AC
Flame resistance	according to IEC 60332-1
	According to DIN EN 60332-1-2
	According to VW-1
	According to FT1
Ambient temperature (operation)	-40 °C ... 90 °C (cable, fixed installation)
	-5 °C ... 90 °C (cable, flexible installation)

Environmental Product Compliance

REACH SVHC	Lead 7439-92-1
China RoHS	Environmentally Friendly Use Period = 50 years
	For details about hazardous substances go to tab "Downloads", Category "Manufacturer's declaration"

Drawings

Power cable - SAC-3P-M12MRS/ 5,0-PVC PE - 1411642

Dimensional drawing

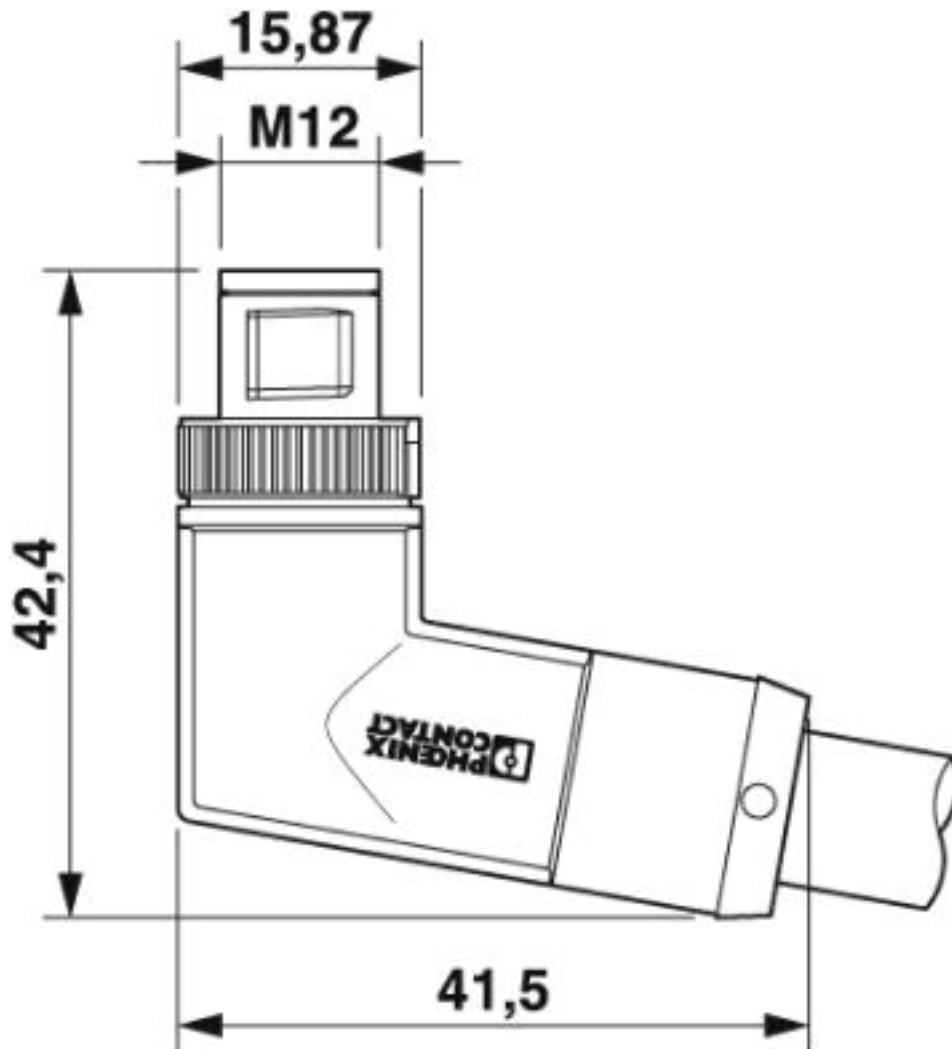

M12 x 1 male plug, angled

Power cable - SAC-3P-M12MRS/ 5,0-PVC PE - 1411642

Schematic diagram

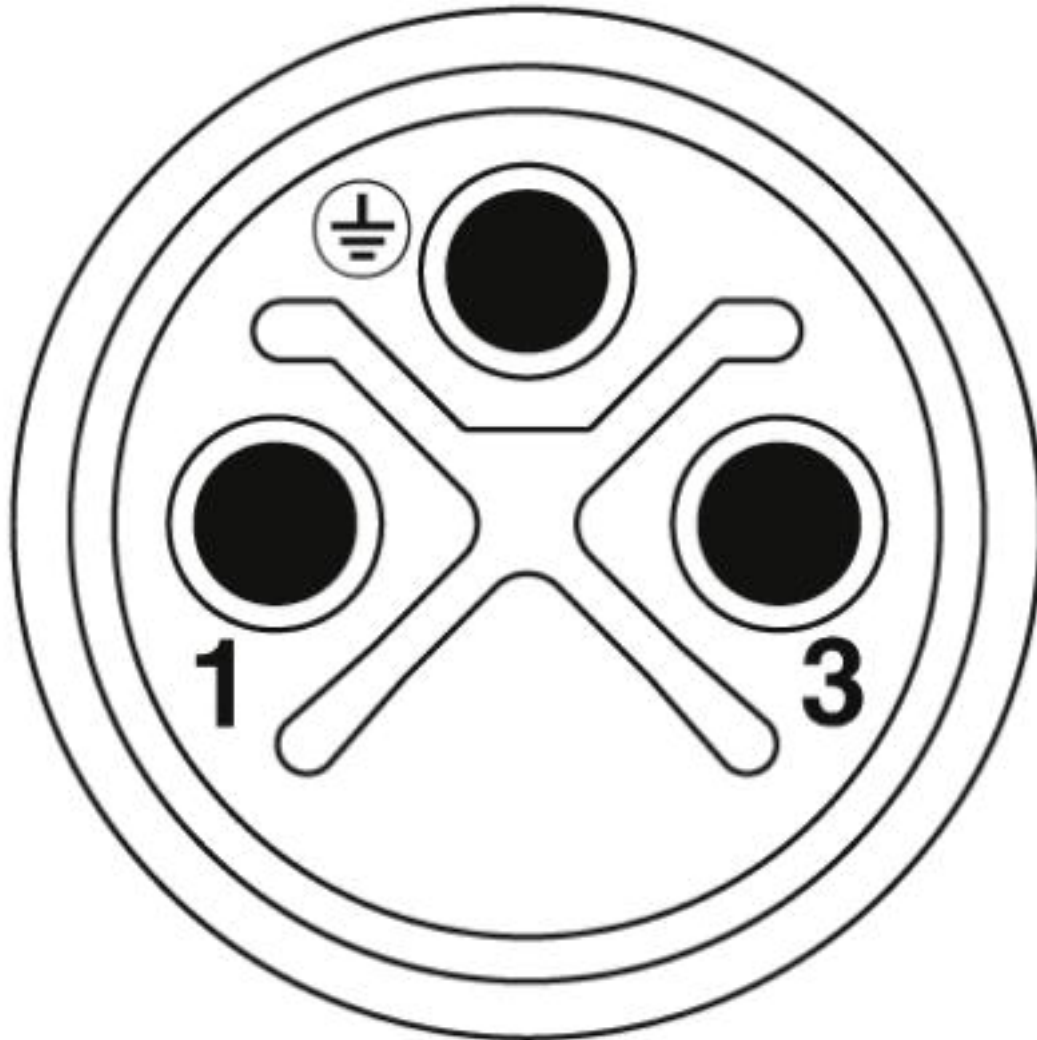

Pin assignment of M12 plug, 3-pos., S-coded, view of pin side

Power cable - SAC-3P-M12MRS/ 5,0-PVC PE - 1411642

Cable cross section

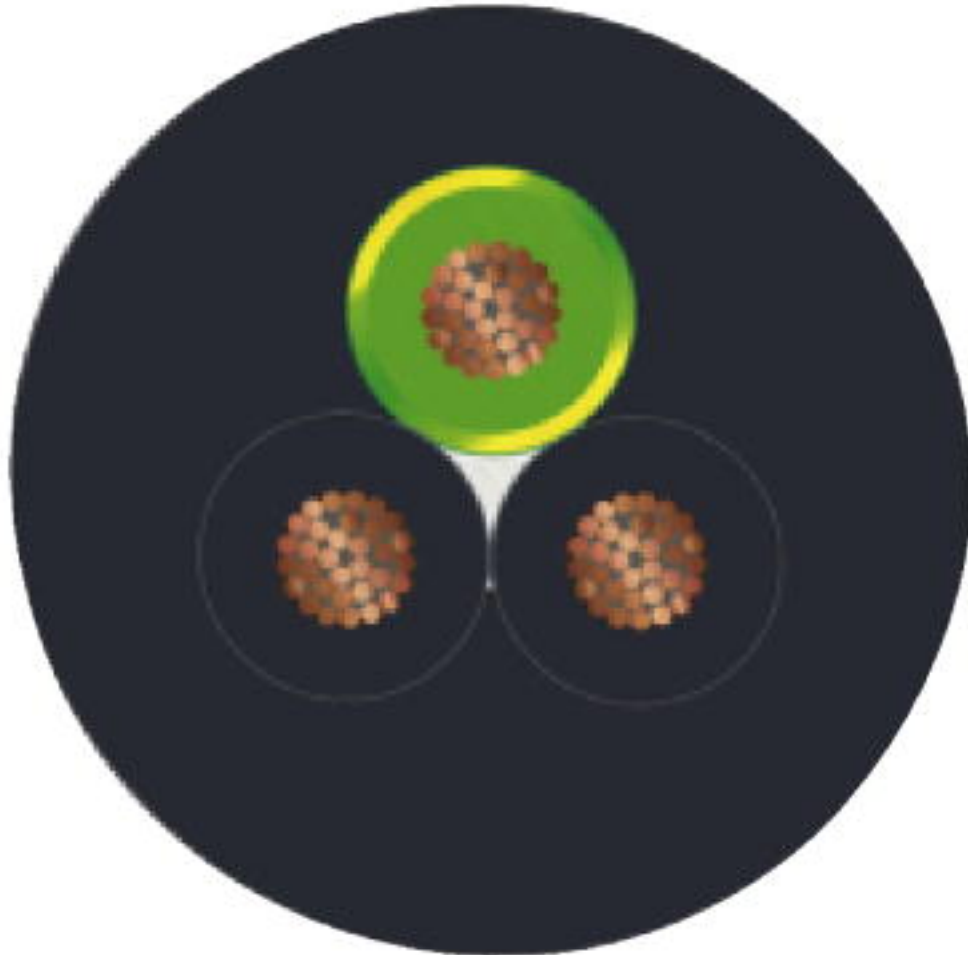

PVC black [PVC]

Classifications

eCl@ss

eCl@ss 10.0.1	27060311
eCl@ss 4.0	27140800
eCl@ss 4.1	27140800
eCl@ss 5.0	27143400
eCl@ss 5.1	27143400
eCl@ss 6.0	27279200
eCl@ss 7.0	27279218
eCl@ss 8.0	27279218
eCl@ss 9.0	27060311

Power cable - SAC-3P-M12MRS/ 5,0-PVC PE - 1411642

Classifications

ETIM

ETIM 4.0	EC001855
ETIM 5.0	EC001855
ETIM 6.0	EC001855
ETIM 7.0	EC001855

UNSPSC

UNSPSC 13.2	31251501
UNSPSC 19.0	31251501
UNSPSC 20.0	31251501
UNSPSC 21.0	31251501

Approvals

Approvals

Approvals

UL Listed / cUL Listed / cULus Listed

Ex Approvals

Approval details

UL Listed		http://database.ul.com/cgi-bin/XYV/template/LISEXT/1FRAME/index.htm	FILE E 468743
Nominal voltage UN	300 V		
Nominal current IN	12 A		
mm ² /AWG/kcmil	16		

cUL Listed		http://database.ul.com/cgi-bin/XYV/template/LISEXT/1FRAME/index.htm	FILE E 468743
Nominal voltage UN	300 V		
Nominal current IN	12 A		
mm ² /AWG/kcmil	16		

Power cable - SAC-3P-M12MRS/ 5,0-PVC PE - 1411642

Approvals

cULus Listed



Accessories

Accessories

Protective cap

Sealing cap - PROT-M12 FS - 1560251



M12 sealing cap for unoccupied M12 plugs of the sensor/actuator cable, flush-type plugs and I/O devices in the field

Screwdriver tools

Tool - SAC BIT M12-D16 - 1200305



Nut for assembling sensor/actuator cables with M12 connector and M12 connectors for assembly, knurl diameter: 16 mm, for 4 mm hexagonal drive

Phoenix Contact 2020 © - all rights reserved
<http://www.phoenixcontact.com>

PHOENIX CONTACT GmbH & Co. KG
Flachsmarktstr. 8
32825 Blomberg
Germany
Tel. +49 5235 300
Fax +49 5235 3 41200
<http://www.phoenixcontact.com>