

Connector set - HC-EVO-B06PT-BWSC-HL-M20-PLRBK - 1407710

Please be informed that the data shown in this PDF Document is generated from our Online Catalog. Please find the complete data in the user's documentation. Our General Terms of Use for Downloads are valid (<http://phoenixcontact.com/download>)



EVO connector set, B6 series, plastic housing, consisting of: 1407727, 1407728, 1407622, 1407619, 1407669, plastic housing

Your advantages

- Lower costs than metal version
- Labeling option using 9 x 20 mm marking label
- Low weight
- Lower risk of condensation
- Both contact insert PE sheets are connected by means of a metal frame integrated in the sleeve housing
- Metal inlays ensure leading PE contact with angled plugs
- Completely corrosion-resistant
- Halogen-free plastic
- Marking label can be attached



Key Commercial Data

Packing unit	1 pc
GTIN	 4 046356 777759
GTIN	404635677759

Technical data

General

Number of positions	6+PE
Type	B6
Connection method	Push-in connection
Cable outlet	straight
	lateral
Degree of protection for housing	IP66
	12 (UL 50e)
Connection method	Push-in connection

Connector set - HC-EVO-B06PT-BWSC-HL-M20-PLRBK - 1407710

Technical data

General

Rated voltage (III/3)	500 V
Rated surge voltage	6 kV
Rated current	16 A
Conductor cross section	0.14 mm ² ... 2.5 mm ² (with ferrule)
Connection cross section AWG	26 ... 14 (with ferrule)
External cable diameter	7 mm ... 13 mm
Ambient temperature (operation)	-40 °C ... 100 °C
Length of the assembly cutout	52 mm
Width of the assembly cutout	35 mm
Housing material	PA
Contact carrier material	PC
Locking latch material	PA
Integrated protective cover	Yes

Standards and Regulations

Flammability rating according to UL 94	V0
--	----

Environmental Product Compliance

China RoHS	Environmentally friendly use period: unlimited = EFUP-e
	No hazardous substances above threshold values

Drawings

Connector set - HC-EVO-B06PT-BWSC-HL-M20-PLRBK - 1407710

Schematic diagram

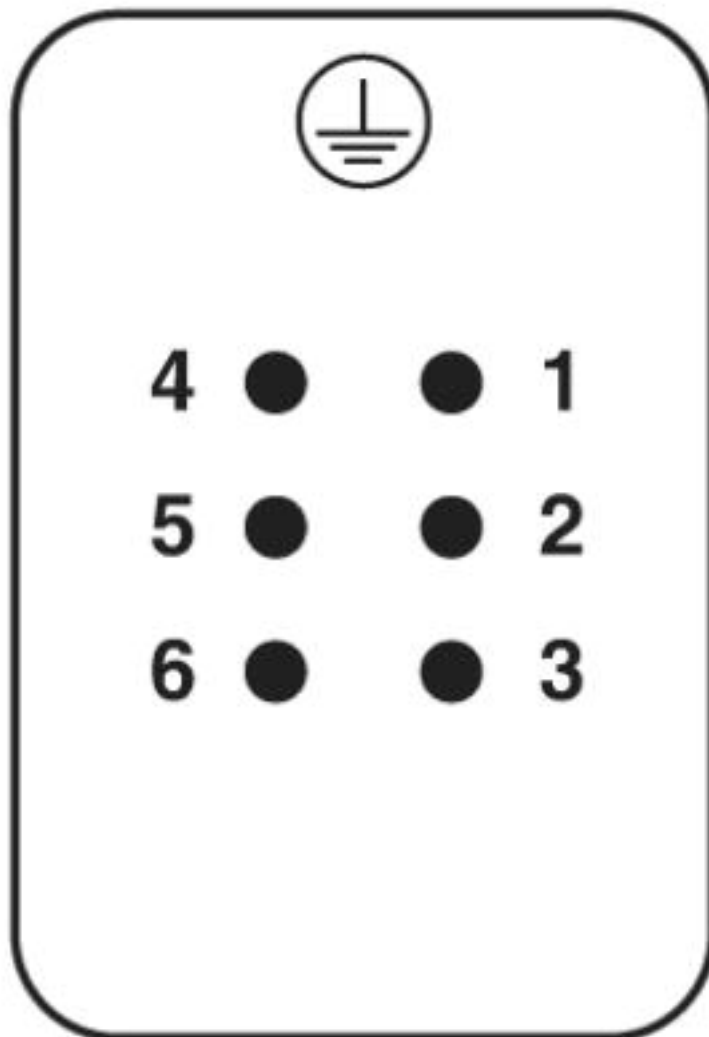

Pin assignment, connection side, pin

Connector set - HC-EVO-B06PT-BWSC-HL-M20-PLRBK - 1407710

Schematic diagram

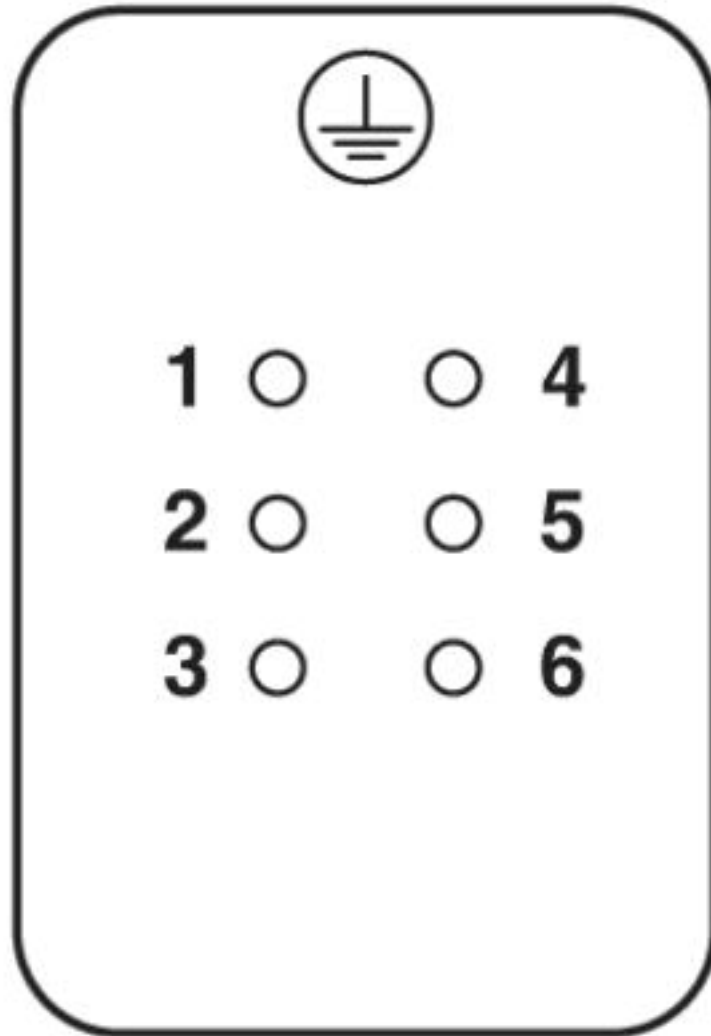

Pin assignment, connection side, socket

Connector set - HC-EVO-B06PT-BWSC-HL-M20-PLRBK - 1407710

Diagram

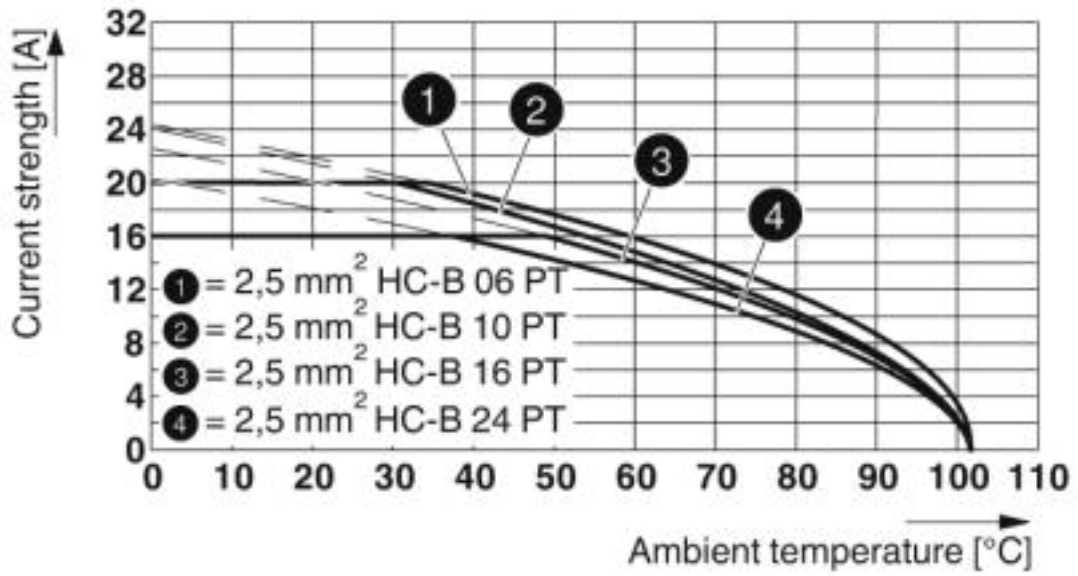

Derating diagram

Connector set - HC-EVO-B06PT-BWSC-HL-M20-PLRBK - 1407710

Dimensional drawing

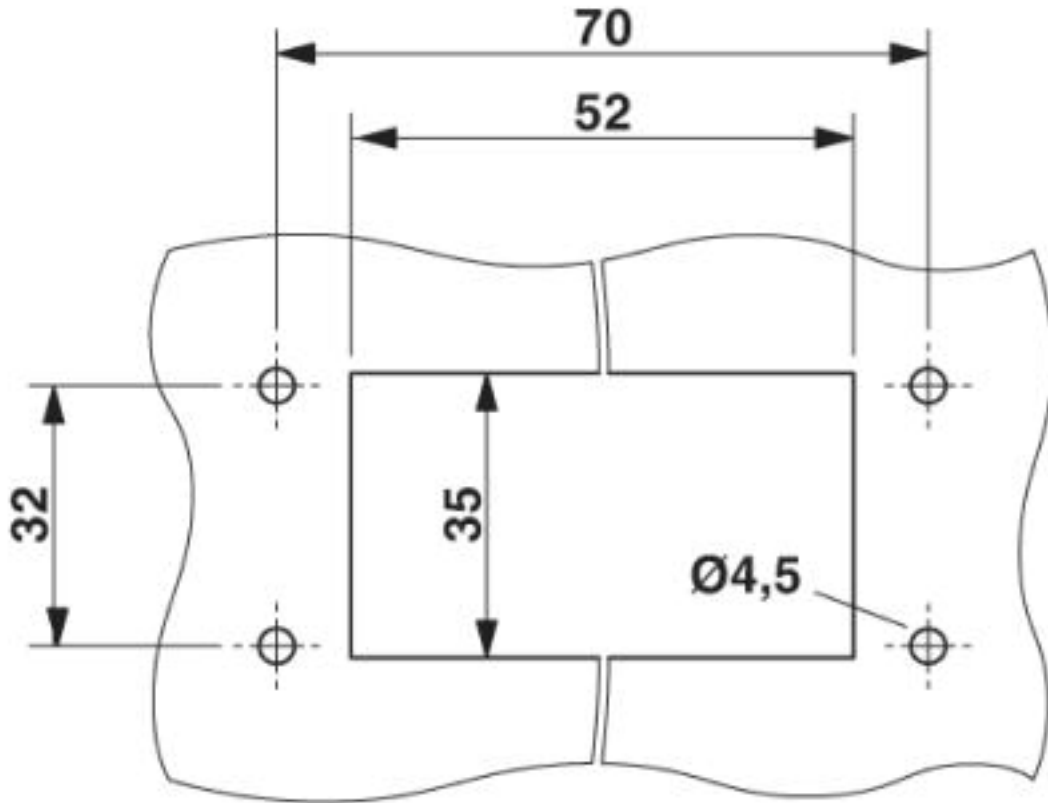

Mounting cutout

Dimensional drawing

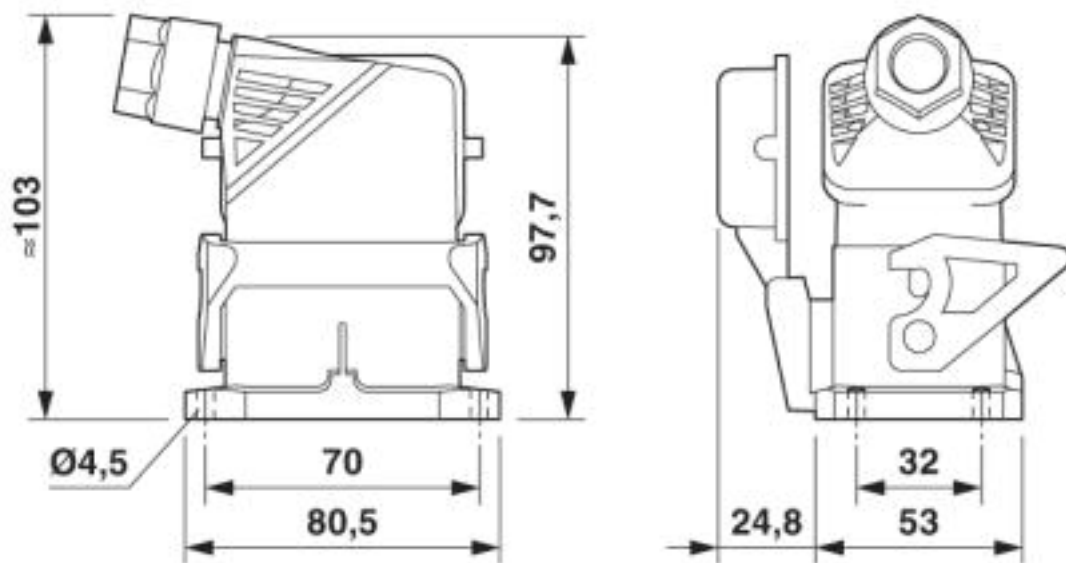

Dimensional drawing

Connector set - HC-EVO-B06PT-BWSC-HL-M20-PLRBK - 1407710

Articles in set

Contact insert - HC-B06-I-PT-F - 1407727



HEAVYCON socket insert, B6 series, 6 + PE-pos., push-in connection

Contact insert - HC-B06-I-PT-M - 1407728



HEAVYCON pin insert, B6 series, 6 + PE-pos., push-in connection

Housing - HC-EVO-B06-BWSC-PLRBK - 1407622



HEAVYCON EVO panel mounting base, plastic, B6, with single locking latch, height: 30.5 mm, with flat gasket, with protective cover

Housing - HC-EVO-B06-HLFS-PLBK - 1407619



HEAVYCON EVO sleeve housing, plastic, with bayonet flange for EVO screw connection, B6, for single locking latch, height: 60.5 mm, without EVO screw connection

Cable gland - HC-B-G-M20-PLRBK - 1407669



EVO plastic cable gland with bayonet locking, for housing series B, size M20, cable diameter: 7 ... 13 mm

Classifications

eCl@ss

eCl@ss 10.0.1	27440101
eCl@ss 4.0	27260700

Connector set - HC-EVO-B06PT-BWSC-HL-M20-PLRBK - 1407710

Classifications

eCl@ss

eCl@ss 4.1	27260700
eCl@ss 5.0	27260700
eCl@ss 5.1	27260700
eCl@ss 6.0	27260700
eCl@ss 7.0	27440101
eCl@ss 8.0	27440101
eCl@ss 9.0	27440101

ETIM

ETIM 3.0	EC000438
ETIM 4.0	EC000437
ETIM 5.0	EC000437
ETIM 6.0	EC002636
ETIM 7.0	EC002636

UNSPSC

UNSPSC 6.01	30211923
UNSPSC 7.0901	39121522
UNSPSC 11	39121522
UNSPSC 12.01	39121522
UNSPSC 13.2	31261501
UNSPSC 18.0	39121409
UNSPSC 19.0	39121409
UNSPSC 20.0	39121409
UNSPSC 21.0	39121409

Approvals

Approvals

Approvals

EAC / DNV GL / EAC

Ex Approvals

Approval details

EAC		RU C- DE.AI30.B.01102
-----	--	--------------------------

Connector set - HC-EVO-B06PT-BWSC-HL-M20-PLRBK - 1407710

Approvals

DNV GL		https://approvalfinder.dnvgl.com/	TAE000037S
--------	---	---	------------

EAC			RU C- DE.BL08.B.00511
-----	---	--	--------------------------

Accessories

Accessories

Device marking

Snap-in markers - US-EMP (20X9) - 0829439



Snap-in markers, Card, white, unlabeled, can be labeled with: BLUEMARK ID COLOR, BLUEMARK ID, THERMOMARK PRIME, THERMOMARK CARD 2.0, THERMOMARK CARD, mounting type: snapped into marker carrier, lettering field size: 20 x 9 mm, Number of individual labels: 70

Housing latches

Single locking latch - HC-B06-SL-PLBK - 1407697



Replacement single locking latch for HEAVYCON EVO housing type B6, PA

Phoenix Contact 2020 © - all rights reserved

<http://www.phoenixcontact.com>

PHOENIX CONTACT GmbH & Co. KG

Flachsmarktstr. 8

32825 Blomberg

Germany

Tel. +49 5235 300

Fax +49 5235 3 41200

<http://www.phoenixcontact.com>