

Hybrid cable - NBC-MSY/ 5,0-94H SCO - 1407489

Please be informed that the data shown in this PDF Document is generated from our Online Catalog. Please find the complete data in the user's documentation. Our General Terms of Use for Downloads are valid (<http://phoenixcontact.com/download>)



Hybrid cable, Ethernet hybrid CAT5 (100 Mbps), 8-position, PUR halogen-free, black RAL 9005, shielded, Plug straight M12 SPEEDCON / IP67, coding: Y, on free cable end, cable length: 5 m, Power with Ethernet (PWE)



Key Commercial Data

Packing unit	1 pc
GTIN	 4 046356 777889
GTIN	4046356777889

Technical data

Dimensions

Length of cable	5 m
-----------------	-----

Ambient conditions

Degree of protection	IP65
	IP67
Ambient temperature (operation)	-25 °C ... 90 °C (M12 connector)

General data

Note	Further products with variable cable type and variable cable length can be found in the accessories section
Rated current at 40°C	6 A (Power) 0.5 A (Data)
Rated voltage	48 V AC (Power and data) 50 V DC (Power and data)
Number of positions	8
Signal type/category	Ethernet hybrid CAT5 (IEC 11801), 100 Mbps
Standards/regulations	M12 connector IEC 61076-2-113
Contact material	CuZn
Contact carrier material	PP / PA 6 GF

Hybrid cable - NBC-MSY/ 5,0-94H SCO - 1407489

Technical data

General data

Contact surface material	Ni/Au
Degree of protection	IP65/IP67

Characteristics head 1

Coding	Y (Hybrid)
Color	black
Material (component)	CuZn (Contact)
	Ni/Au (Contact surface)
	PP (Contact carrier, data)
	PA (Contact carrier, power)
	TPU, hardly inflammable, self-extinguishing (Grip)
	Zinc die-cast, nickel-plated (Screw connection)
Shielded	yes
Insulation resistance	≥ 100 MΩ
Insertion/withdrawal cycles	≥ 100
Torque	0.4 Nm
Ambient temperature (operation)	-25 °C ... 90 °C
Shielded	yes
Outer sheath, material	PUR
External sheath, color	black RAL 9005
Type type, plug side	Plug straight
Type type, socket side	free cable end

Characteristics head 2

Color	black
-------	-------

Standards and Regulations

Standards/specifications	M12 connector IEC 61076-2-113
--------------------------	-------------------------------

Cable

Cable type	Ethernet hybrid
Cable type (abbreviation)	94H
UL AWM style	20963 (80°C/30 V)
Cable structure	1x4xAWG26+1x4xAWG20
Conductor cross section	4x 0.15 mm ² (Data)
	4x 0.6 mm ² (Power)
AWG signal line	26
AWG power supply	20
Conductor structure signal line	19x 0.10 mm
Conductor structure, voltage supply	19x 0.20 mm
Core diameter including insulation	1.05 mm (Data)
	1.4 mm (Power)
Wire colors	White/orange, orange, white/green, green, white, blue, brown, black

Hybrid cable - NBC-MSY/ 5,0-94H SCO - 1407489

Technical data

Cable

Overall twist	1 star quad and 4 wires with 2 fillers
Shielding	Tinned copper braided shield
Optical shield covering	85 %
External sheath, color	black RAL 9005
External cable diameter D	7.6 mm ±0.2 mm
Minimum bending radius, fixed installation	5 x D
Minimum bending radius, flexible installation	10 x D
Number of bending cycles	2000000
Minimum bending radius, drag chain applications	10 x D
Traversing path	4.5 m
Traversing rate	3 m/s
Acceleration	3 m/s ²
Tensile strength GRP	70 N (in accordance with DIN EN 50565-1 for flexible installation) 240 N (in accordance with DIN EN 50565-1 for fixed installation)
Cable weight	87 kg/km
Outer sheath, material	PUR
Material conductor insulation	PP (Data) PP (Power)
Conductor material	Bare Cu litz wires
Insulation resistance	≥ 5 GΩ*km
Loop resistance	≤ 280.00 Ω/km (Data) ≤ 34.60 Ω/km (Power)
Working capacitance	nom. 50 nF (per kilometer)
Wave impedance	100 Ω ±15 Ω (4 MHz ... 100 MHz)
Near end crosstalk attenuation (NEXT)	56.3 dB (at 4 MHz) 50.3 dB (at 10 MHz) 47.2 dB (at 16 MHz) 45.8 dB (at 20 MHz) 42.9 dB (at 31.25 MHz) 38.4 dB (at 62.5 MHz) 35.3 dB (at 100 MHz)
Attenuation	6 dB (at 4 MHz) 9.5 dB (at 10 MHz) 12.1 dB (at 16 MHz) 13.5 dB (at 20 MHz) 17.1 dB (at 31.25 MHz) 24.8 dB (at 62.5 MHz) 32 dB (at 100 MHz)
Shield attenuation	≥ 80 dB (30 MHz ... 125 MHz)
Differential impedance	100 Ω ±5 % (at 100 MHz)

Hybrid cable - NBC-MSY/ 5,0-94H SCO - 1407489

Technical data

Cable

Nominal voltage, cable	≤ 50 V (Peak value, not for high-power applications)
Test voltage Core/Core	1500 V (50 Hz, 1 min.)
Test voltage Core/Shield	1500 V (50 Hz, 1 min.)
Special properties	Free of substances which would hinder coating with paint or varnish
	Silicone-free
Flame resistance	in acc. with UL 1581, section 1061
Halogen-free	according to IEC 60754
	in accordance with DIN VDE 0472 part 815
Resistance to oil	according to IEC 60811-2-1
	according to VDE 0282 Part 10
Other resistance	Low adhesion
Ambient temperature (operation)	-40 °C ... 90 °C (cable, fixed installation)
	-30 °C ... 70 °C (cable, flexible installation)

Environmental Product Compliance

REACH SVHC	Lead 7439-92-1
China RoHS	Environmentally Friendly Use Period = 50 years
	For details about hazardous substances go to tab "Downloads", Category "Manufacturer's declaration"

Drawings

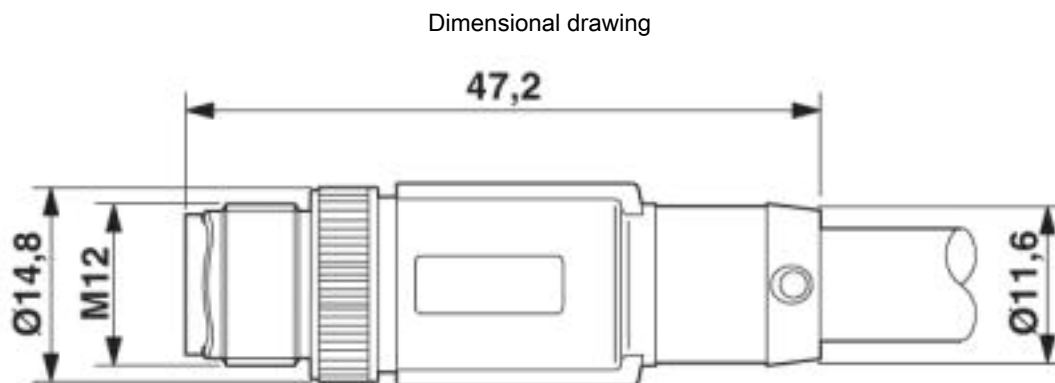

Plug, M12 x 1, straight, shielded

Hybrid cable - NBC-MSY/ 5,0-94H SCO - 1407489

Circuit diagram

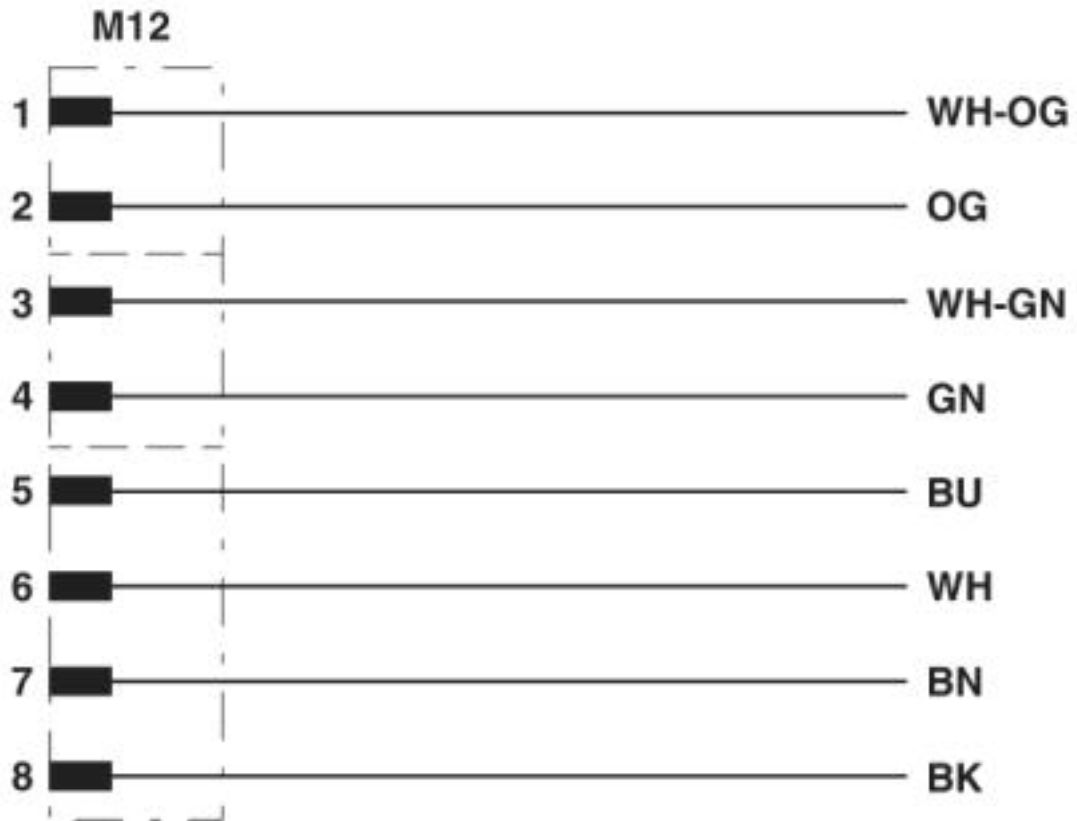

Contact assignment of the M12 plug

Hybrid cable - NBC-MSY/ 5,0-94H SCO - 1407489

Schematic diagram

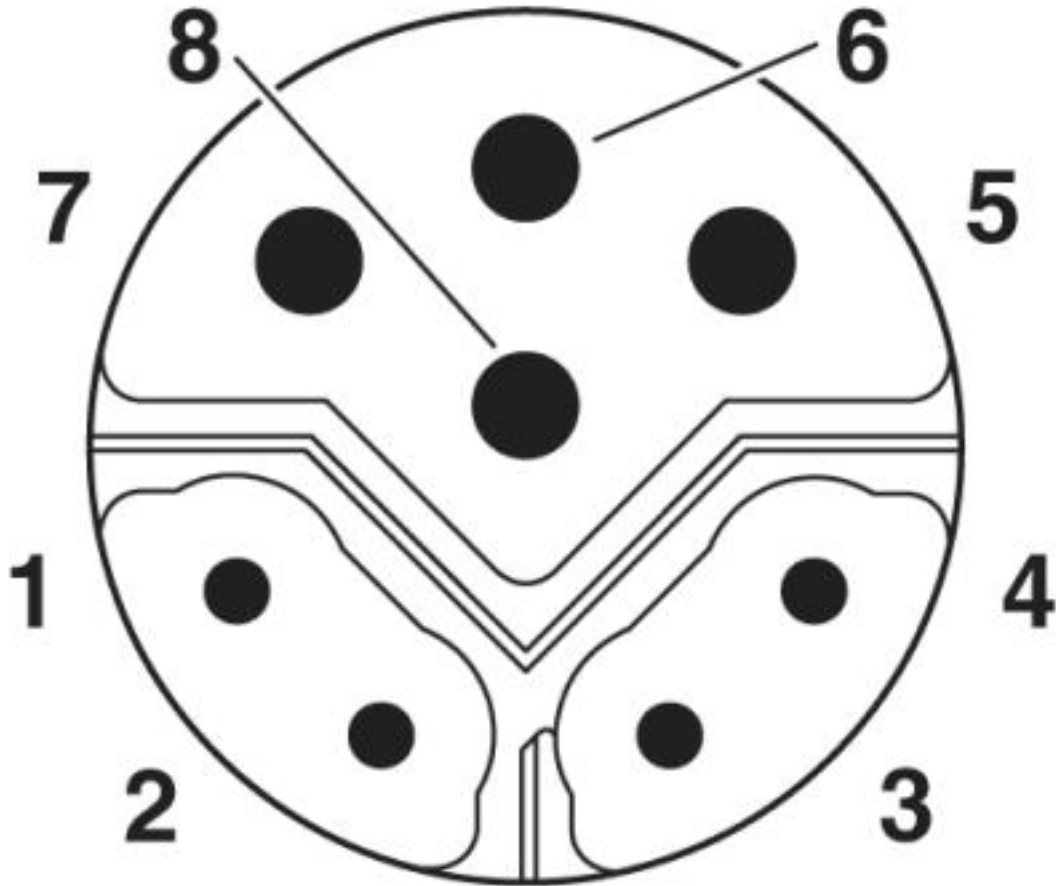

M12 hybrid plug pin assignment, 8-pos., Y-coded, pin side view

Hybrid cable - NBC-MSY/ 5,0-94H SCO - 1407489

Cable cross section



Ethernet hybrid [94H]

Classifications

eCl@ss

eCl@ss 10.0.1	27060308
eCl@ss 4.0	27060300
eCl@ss 4.1	27060300
eCl@ss 5.0	27060300
eCl@ss 5.1	27060300
eCl@ss 6.0	27279200
eCl@ss 7.0	27279218
eCl@ss 8.0	27279218
eCl@ss 9.0	27060308

Hybrid cable - NBC-MSY/ 5,0-94H SCO - 1407489

Classifications

ETIM

ETIM 3.0	EC000830
ETIM 4.0	EC001855
ETIM 5.0	EC002599
ETIM 6.0	EC001262
ETIM 7.0	EC001262

UNSPSC

UNSPSC 6.01	26121609
UNSPSC 7.0901	26121609
UNSPSC 11	26121609
UNSPSC 12.01	26121609
UNSPSC 13.2	31251501
UNSPSC 18.0	26121604
UNSPSC 19.0	26121604
UNSPSC 20.0	26121604
UNSPSC 21.0	26121604

Approvals

Approvals

Approvals

UL Listed / cUL Listed / EAC / cULus Listed

Ex Approvals

Approval details

UL Listed		http://database.ul.com/cgi-bin/XYV/template/LISEXT/1FRAME/index.htm	FILE E 335024
Nominal voltage UN	56.5 V		
Nominal current IN	0.175 A		

cUL Listed		http://database.ul.com/cgi-bin/XYV/template/LISEXT/1FRAME/index.htm	FILE E 335024
Nominal voltage UN	56.5 V		

Hybrid cable - NBC-MSY/ 5,0-94H SCO - 1407489

Approvals

Nominal current I _N	0.175 A
--------------------------------	---------

EAC		RU D- DE.HB35.B.00387
-----	--	--------------------------

cULus Listed	
--------------	--

Accessories

Accessories

Corrugated pipe

Protective hose - WP-PA HF 13,0 BK - 3240681



Polyamide protective hose, inflammability class V0, UV resistant

Protective hose - WP-PA HF-HB 13,0 BK - 3240839



Polyamide protective hose, inflammability class HB, UV resistant

Cutting tools

Cable-cutting tool - CUTFOX 12 - 1212128



Cable cutter, for copper and aluminum up to 12 mm diameter (up to 35 mm²)

Hybrid cable - NBC-MSY/ 5,0-94H SCO - 1407489

Accessories

Diagonal cutter - CUTFOX-S VDE - 1212207



Diagonal cutter for hard (piano wire) and soft wires, VDE 1000 V AC/1500 V DC tested

Data cable preassembled

Hybrid cable - NBC-MSY SCO-EH/.../... - 1408642



Hybrid cable, Ethernet hybrid CAT5 (100 Mbps), 8-position, Variable cable type, shielded, Plug straight M12 SPEEDCON / IP67, coding: Y, on free cable end, cable length: Free input (0.2 ... 40.0 m), Power with Ethernet (PWE)

Electronics pliers

Diagonal cutter - MICROFOX-SP-1 - 1212487



Electronic diagonal cutter, tapered head, without chamfer, with opening spring, non-reflective phosphate-treated surface, punched version

Protective cap

Sealing cap - PROT-M12 FS-PA-CHAIN - 1430873

M12 sealing cap made of plastic with fixing band, for sensor cables, for free M12 plugs



Safety locking

Locking clip - SAC-M12-EXCLIP-M - 1558988



Locking clip for the pin side of sensor/actuator cables with M12 connector and M12 connectors for assembly, for knurl diameter: 15 mm or for Allen key with a wrench size of 14 mm, prevents the disconnection of plug-in connections without tools

Hybrid cable - NBC-MSY/ 5,0-94H SCO - 1407489

Accessories

Screwdriver tools

Adapter insert - TSD-M SAC-BIT ADAPTER - 1212600



Adapter bit for TSD-M...torque tools, E6.3-1/4" drive with 4 mm hexagon to accommodate SAC bits

Tool - SAC BIT M12-D15 - 1208432



Nut for assembling sensor/actuator cables with M12 connector and M12 connectors for assembly, with a knurl diameter of 15 mm, for 4 mm hexagonal drive

Stripping tool

Stripping tool - WIREFOX 4 - 1212156



Stripping tool, for cables and conductors (especially for rubber and silicone insulations) from 0.1 - 4 mm², self-adjusting, stripping length of up to 18 mm, cutting capacity of up to 10 mm² stranded/1.5 mm² solid, replaceable stripping blade

Stripping tool - WIREFOX-E 4 - 1212704



Stripping tool, for cables and conductors (especially for rubber and silicone insulations) from 0.1 - 4 mm², self-adjusting, stripping length of up to 18 mm, cutting capacity of up to 10 mm² stranded/1.5 mm² solid, replaceable stripping blade

Stripping tool - WIREFOX 10 - 1212150



Stripping tool, for cables and conductors from 0.02 - 10 mm², self-adjusting, stripping length of up to 18 mm, cutting capacity of up to 10 mm² stranded/1.5 mm² solid, replaceable stripping blade

Torque tool

Hybrid cable - NBC-MSY/ 5,0-94H SCO - 1407489

Accessories

Torque screwdriver - TSD 04 SAC - 1208429



Torque screwdriver, with preset torque of 0.4 Nm and 4 mm hexagonal drive for M12 connectors

Torque screwdriver - TSD-M 1,2NM - 1212224



Torque screw driver, accuracy as per EN ISO 6789 standard, adjustable from 0.3 - 1.2 Nm

Stripping tool - VS-CABLE-STRIP-VARIO - 1657407



Stripping tool, for the multi-level stripping of shielded cables

Protective hose adapter - WP-CTA POM 13,0 BK - 1422884



Protective hose adapter, for corrugated hoses with a nominal size of 13 (10 x 13), corrugated in parallel

Phoenix Contact 2020 © - all rights reserved
<http://www.phoenixcontact.com>

PHOENIX CONTACT GmbH & Co. KG
Flachsmarktstr. 8
32825 Blomberg
Germany
Tel. +49 5235 300
Fax +49 5235 3 41200
<http://www.phoenixcontact.com>