

Sensor/actuator cable - SAC-4P- 5,0-28R/FR SCO RAIL - 1407321

Please be informed that the data shown in this PDF Document is generated from our Online Catalog. Please find the complete data in the user's documentation. Our General Terms of Use for Downloads are valid (<http://phoenixcontact.com/download>)



Sensor/actuator cable, 4-position, PE-X halogen-free, black, shielded, free cable end, on Socket angled M12 SPEEDCON, coding: A, cable length: 5 m, For railway applications

Your advantages

- ✓ Easy and safe: 100% electrically tested plug-in components
- ✓ Safety thanks to flame retardancy: PA 6.6 grip and radiation-cross-linked cables satisfy the most stringent requirements
- ✓ Securely locked by special vibration brake
- ✓ Resistant to temperature influences – tested for an extended temperature range and for resistance to temperature shocks
- ✓ Reliable signal transmission – 360° shielding in environments with electromagnetic interference



Key Commercial Data

Packing unit	1 pc
GTIN	 4 046356 774376
GTIN	4046356774376

Technical data

Dimensions

Length of cable	5 m
-----------------	-----

Ambient conditions

Ambient temperature (operation)	-40 °C ... 85 °C (Plug / socket)
Degree of protection	IP65

General

Note	Further products with variable cable type and variable cable length can be found in the accessories section
Rated current at 40°C	4 A
Rated voltage	48 V AC
	60 V DC
Number of positions	4

Sensor/actuator cable - SAC-4P- 5,0-28R/FR SCO RAIL - 1407321

Technical data

General

Color handle area	black
Insulation resistance	≥ 100 MΩ
Coding	A - standard
Standards/regulations	M12 connector IEC 61076-2-101
	Shock, vibration EN 50155
Status display	No
Protective circuit/component	unwired
Overvoltage category	II
Degree of pollution	3
Insertion/withdrawal cycles	≥ 100
Torque	0.4 Nm (M12 connector)

Material

Flammability rating according to UL 94	V0
Contact material	CuSn
Contact surface material	Ni/Au
Contact carrier material	PA 6.6
Material of grip body	PA 6.6
Material, knurls	Zinc die-cast, nickel-plated
Sealing material	NBR

Standards and Regulations

Standards/specifications	M12 connector IEC 61076-2-101
	Shock, vibration EN 50155
Flammability rating according to UL 94	V0

Cable

Cable type	Shielded black RADOX®
Cable type (abbreviation)	28R
Conductor cross section	4x 0.5 mm ²
AWG signal line	20
Conductor structure signal line	19x 0.18 mm
Core diameter including insulation	1.43 mm
Wire colors	White 1, white 2, white 3, white 4
Overall twist	4 wires, twisted
Shielding	Tinned copper braided shield
External sheath, color	black
External cable diameter D	5.4 mm ±0.3 mm
Minimum bending radius, fixed installation	3 x D
Minimum bending radius, flexible installation	4 x D
Cable weight	56 kg/km
Outer sheath, material	PE-X

Sensor/actuator cable - SAC-4P- 5,0-28R/FR SCO RAIL - 1407321

Technical data

Cable

Material conductor insulation	PE-X
Conductor material	Tin-plated Cu litz wires
Conductor resistance	≤ 40.1 Ω/km
Nominal voltage, cable	600 V AC (Core-ground, U ₀)
	1000 V AC (Core-ground, U)
	≤ 720 V AC (core-ground)
	≤ 1200 V AC (Core-ground, U _m)
	≤ 900 V DC (Core-ground, V ₀)
	≤ 1500 V DC (core-core)
Test voltage, cable	3500 V AC (50 Hz, 5 min.)
	8400 V DC (50 Hz, 5 min.)
Fire protection in rail vehicles	BS 6853 (Category Ia, Ib, II)
	GM/RT 2130 (Category Ia, Ib, II)
	EN 45545 (Risk level HL1 - HL3)
	DIN 5510 (Fire protection level 1, 2, 3, 4)
	NF F16-101 (Category A1, A2, B)
	NF F16-101 (Class C/F0)
	NFPA 130
	UNI CEI 11170 (Risk level LR1 - LR4)
Flame resistance	EN 60332-1-2
	EN 50266
	EN 50305, 9.1.2
	NF C32-070, 2.1
	NF C32-070, 2.2
	UL 1685, 12 (FT4)
	in accordance with ISO 6722-1 5.22 (UN ECE-R 118.01)
Halogen-free	According to EN 50267-2-1
Resistance to oil	according to IRM 902, 72 h at 100 °C
Other resistance	Resistance to fuels according to IRM 903, 168 h at 70 °C
Concentration of fumes	BS 6853 D.8.7
	EN 61034-2
	UL 1685, 12 (FT4)
Fume corrosiveness	EN 50267-2-2
Fume toxicity	BS 6853 B.1
	EN 50305, 9.2
Ambient temperature (operation)	-50 °C ... 120 °C (cable, fixed installation)
	-25 °C ... 90 °C (cable, flexible installation)

Environmental Product Compliance

China RoHS	Environmentally friendly use period: unlimited = EFUP-e
------------	---

Sensor/actuator cable - SAC-4P- 5,0-28R/FR SCO RAIL - 1407321

Technical data

Environmental Product Compliance

	No hazardous substances above threshold values
--	--

Drawings

Dimensional drawing

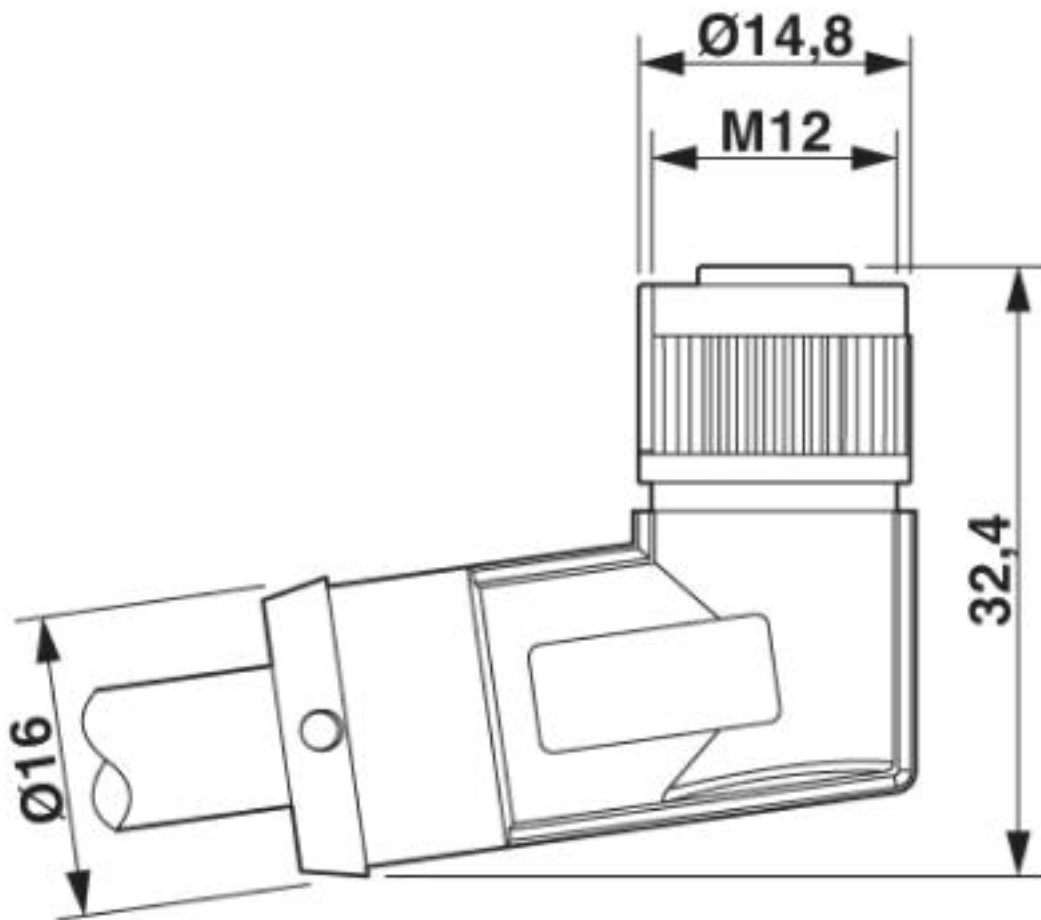

Socket M12-SPEEDCON, angled, shielded

Sensor/actuator cable - SAC-4P- 5,0-28R/FR SCO RAIL - 1407321

Circuit diagram

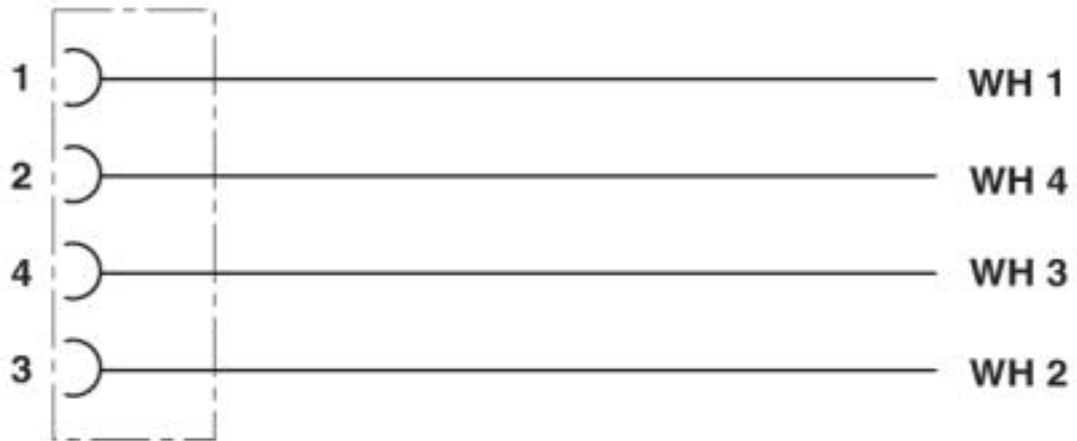

Contact assignment of the M12 socket

Sensor/actuator cable - SAC-4P- 5,0-28R/FR SCO RAIL - 1407321

Schematic diagram

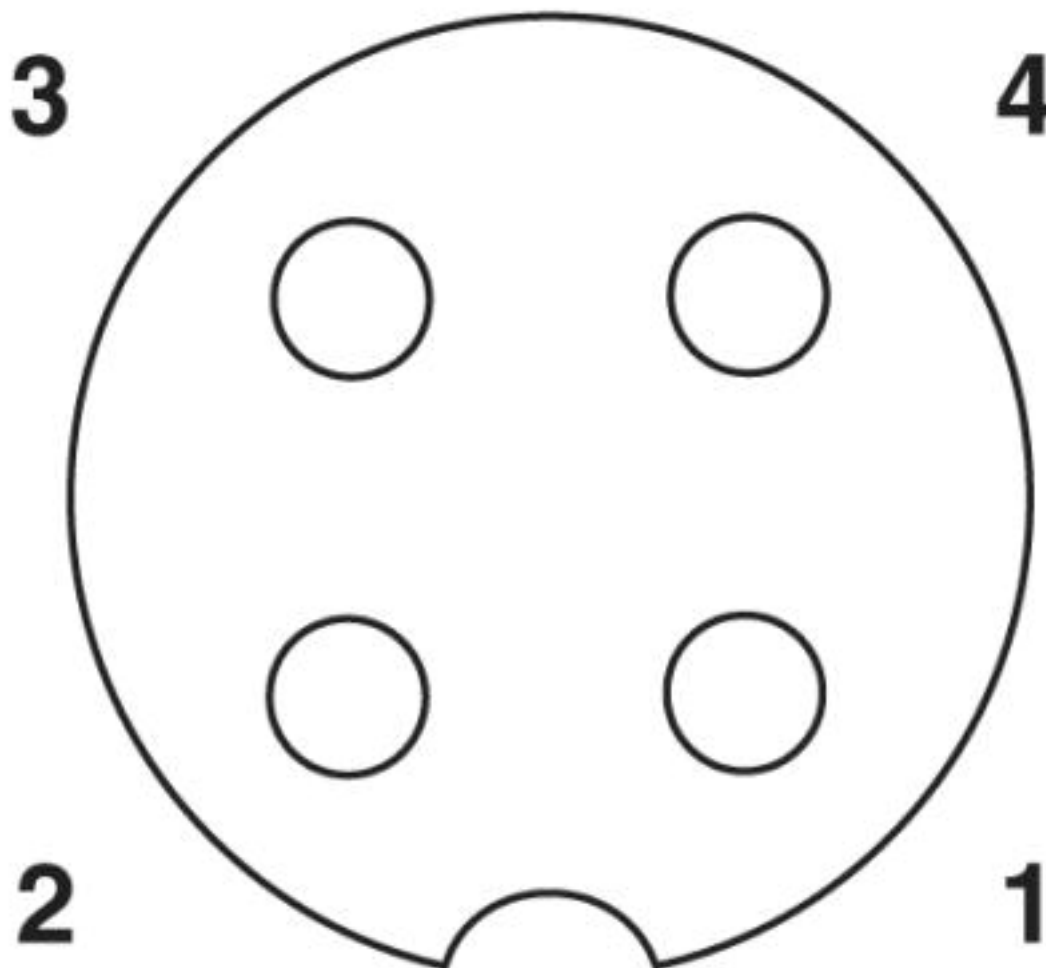

Pin assignment M12 socket, 4-pos., A-coded, view female side

Sensor/actuator cable - SAC-4P- 5,0-28R/FR SCO RAIL - 1407321

Cable cross section



Shielded black RADOX® [28R]

Classifications

eCl@ss

eCl@ss 10.0.1	27060311
eCl@ss 4.0	27060300
eCl@ss 4.1	27060300
eCl@ss 5.0	27061800
eCl@ss 5.1	27061800
eCl@ss 6.0	27279200
eCl@ss 7.0	27279218
eCl@ss 8.0	27279218
eCl@ss 9.0	27060311

Sensor/actuator cable - SAC-4P- 5,0-28R/FR SCO RAIL - 1407321

Classifications

ETIM

ETIM 3.0	EC001855
ETIM 4.0	EC001855
ETIM 5.0	EC001855
ETIM 6.0	EC001855
ETIM 7.0	EC001855

UNSPSC

UNSPSC 6.01	31251501
UNSPSC 7.0901	31251501
UNSPSC 11	31251501
UNSPSC 12.01	31251501
UNSPSC 13.2	31251501
UNSPSC 19.0	31251501
UNSPSC 20.0	31251501
UNSPSC 21.0	31251501

Accessories

Accessories

Circular connector (cable-side)

Connector - SACC-MS-4QO-0,75 SH SCO - 1413993



Connector, Universal, 4-position, halogen-free, shielded, Plug straight M12 SPEEDCON, Coding: A, Insulation displacement connection, knurl material: Zinc die-cast, nickel-plated, external cable diameter 5 mm ... 9.7 mm

Connector - SACC-FS-4QO-0,75 SH SCO - 1413994



Connector, Universal, 4-position, halogen-free, shielded, Socket straight M12 SPEEDCON, Coding: A, Insulation displacement connection, knurl material: Zinc die-cast, nickel-plated, external cable diameter 5 mm ... 9.7 mm

Connector - SACC-M12MS-4PL SH - 1424666



Connector, Universal, 4-position, shielded, Plug straight M12, Coding: A, Push-in connection, knurl material: Zinc die-cast, nickel-plated, external cable diameter 4 mm ... 8 mm

Sensor/actuator cable - SAC-4P- 5,0-28R/FR SCO RAIL - 1407321

Accessories

Connector - SACC-M12MR-4PL SH - 1424667



Connector, Universal, 4-position, shielded, Plug angled M12, Coding: A, Push-in connection, knurl material: Zinc die-cast, nickel-plated, external cable diameter 4 mm ... 8 mm

Connector - SACC-M12FS-4PL SH - 1424668



Connector, Universal, 4-position, shielded, Socket straight M12, Coding: A, Push-in connection, knurl material: Zinc die-cast, nickel-plated, external cable diameter 4 mm ... 8 mm

Connector - SACC-M12FR-4PL SH - 1424669



Connector, Universal, 4-position, shielded, Socket angled M12, Coding: A, Push-in connection, knurl material: Zinc die-cast, nickel-plated, external cable diameter 4 mm ... 8 mm

Connector - SACC-M12MS-5CT-CM SH - 1422850



Connector, Universal, 5-position, shielded, Plug straight M12, Coding: A, Crimp connection, knurl material: Zinc die-cast, nickel-plated, external cable diameter 4.5 mm ... 7.5 mm, without crimp contacts

Connector - SACC-M12MR-5CT-CM SH - 1422851



Connector, Universal, 5-position, shielded, Plug angled M12, Coding: A, Crimp connection, knurl material: Zinc die-cast, nickel-plated, external cable diameter 4.5 mm ... 7.5 mm, without crimp contacts

Sensor/actuator cable - SAC-4P- 5,0-28R/FR SCO RAIL - 1407321

Accessories

Connector - SACC-M12FS-5CT-CM SH - 1422852



Connector, Universal, 5-position, shielded, Socket straight M12, Coding: A, Crimp connection, knurl material: Zinc die-cast, nickel-plated, external cable diameter 4.5 mm ... 7.5 mm, without crimp contacts

Connector - SACC-M12FR-5CT-CM SH - 1422853



Connector, Universal, 5-position, shielded, Socket angled M12, Coding: A, Crimp connection, knurl material: Zinc die-cast, nickel-plated, external cable diameter 4.5 mm ... 7.5 mm, without crimp contacts

Connector - SACC-P12MS-5CT-CM SH - 1021815



Connector, Universal, 5-position, shielded, Plug straight M12 Push-Pull, Coding: A, Crimp connection, knurl material: PA 6.6, external cable diameter 4.5 mm ... 7.5 mm, without crimp contacts

Connector - SACC-P12MR-5CT-CM SH - 1021816



Connector, Universal, 5-position, shielded, Plug angled M12 Push-Pull, Coding: A, Crimp connection, knurl material: PA 6.6, external cable diameter 4.5 mm ... 7.5 mm, without crimp contacts

Conductor marking

Cable marker - WMTB HF (40X12)R YE - 0830408



Cable marker, Roll, yellow, unlabeled, can be labeled with: THERMOMARK ROLLMASTER 300/600, THERMOMARK X1.2, THERMOMARK ROLL X1, THERMOMARK ROLL 2.0, THERMOMARK ROLL, mounting type: Assembly with cable binders, cable diameter: ≥ 6 mm, lettering field size: 40 x 12 mm, Number of individual labels: 1000

Sensor/actuator cable - SAC-4P- 5,0-28R/FR SCO RAIL - 1407321

Accessories

Cable marker - WMTB HF (55X15)R YE - 0830410



Cable marker, Roll, yellow, unlabeled, can be labeled with: THERMOMARK ROLLMASTER 300/600, THERMOMARK X1.2, THERMOMARK ROLL X1, THERMOMARK ROLL 2.0, THERMOMARK ROLL, mounting type: Assembly with cable binders, cable diameter: ≥ 6 mm, lettering field size: 55 x 15 mm, Number of individual labels: 1000

Cable marker - WMTB HF (55X25)R YE - 0830412



Cable marker, Roll, yellow, unlabeled, can be labeled with: THERMOMARK ROLLMASTER 300/600, THERMOMARK X1.2, THERMOMARK ROLL X1, THERMOMARK ROLL 2.0, THERMOMARK ROLL, mounting type: Assembly with cable binders, cable diameter: ≥ 6 mm, lettering field size: 55 x 25 mm, Number of individual labels: 500

Conductor marking - UCT-WMCO 5,4 (23X8) - 0832105



Conductor marking, Sheet, white, unlabeled, can be labeled with: TOPMARK NEO, TOPMARK LASER, BLUEMARK ID COLOR, BLUEMARK ID, BLUEMARK CLED, THERMOMARK PRIME, THERMOMARK CARD 2.0, THERMOMARK CARD, mounting type: clip on, cable diameter range: 4.7 ... 5.4 mm, lettering field size: 23 x 8 mm, Number of individual labels: 18

Conductor marking - UCT-WMCO 6,1 (23X8) - 0832106



Conductor marking, Sheet, white, unlabeled, can be labeled with: TOPMARK NEO, TOPMARK LASER, BLUEMARK ID COLOR, BLUEMARK ID, BLUEMARK CLED, THERMOMARK PRIME, THERMOMARK CARD 2.0, THERMOMARK CARD, mounting type: clip on, cable diameter range: 5.4 ... 6.1 mm, lettering field size: 23 x 8 mm, Number of individual labels: 18

Conductor marking - UCT-WMCO 6,8 (23X8) - 0832107



Conductor marking, Sheet, white, unlabeled, can be labeled with: TOPMARK NEO, TOPMARK LASER, BLUEMARK ID COLOR, BLUEMARK ID, BLUEMARK CLED, THERMOMARK PRIME, THERMOMARK CARD 2.0, THERMOMARK CARD, mounting type: clip on, cable diameter range: 6.1 ... 6.8 mm, lettering field size: 23 x 8 mm, Number of individual labels: 15

Sensor/actuator cable - SAC-4P- 5,0-28R/FR SCO RAIL - 1407321

Accessories

Conductor marking - UCT-WMCO 7,5 (23X8) - 0832108



Conductor marking, Sheet, white, unlabeled, can be labeled with: TOPMARK NEO, TOPMARK LASER, BLUEMARK ID COLOR, BLUEMARK ID, BLUEMARK CLED, THERMOMARK PRIME, THERMOMARK CARD 2.0, THERMOMARK CARD, mounting type: clip on, cable diameter range: 6.8 ... 7.5 mm, lettering field size: 23 x 8 mm, Number of individual labels: 15

Cable marker - WMTB-AL (40X15) - 0830524



Cable marker, Aluminum label, aluminum color, unlabeled, can be labeled with: BLUEMARK ID COLOR, BLUEMARK ID, BLUEMARK CLED, mounting type: Assembly with cable binders, cable diameter: > 4.6 mm, lettering field size: 40 x 15 mm

Cable marker - WMTB-AL (60X15) - 0830525



Cable marker, Aluminum label, aluminum color, unlabeled, can be labeled with: BLUEMARK ID COLOR, BLUEMARK ID, BLUEMARK CLED, mounting type: Assembly with cable binders, cable diameter: > 4.6 mm, lettering field size: 60 x 15 mm

Cable marker - LS-WMTB-AL (40X15) - 0831501



Cable marker, Aluminum label, aluminum color, unlabeled, can be labeled with: TOPMARK NEO, TOPMARK LASER, mounting type: Assembly with cable binders, cable diameter: > 4.6 mm, lettering field size: 40 x 15 mm, Number of individual labels: 16

Cable marker - LS-WMTB-AL (40X15) BK - 0831509



Cable marker, Aluminum label, black, unlabeled, can be labeled with: TOPMARK NEO, TOPMARK LASER, mounting type: Assembly with cable binders, cable diameter: > 4.6 mm, lettering field size: 40 x 15 mm, Number of individual labels: 16

Sensor/actuator cable - SAC-4P- 5,0-28R/FR SCO RAIL - 1407321

Accessories

Cable marker - LS-WMTB-AL (60X15) - 0831502



Cable marker, Aluminum label, aluminum color, unlabeled, can be labeled with: TOPMARK NEO, TOPMARK LASER, mounting type: Assembly with cable binders, cable diameter: > 4.6 mm, lettering field size: 60 x 15 mm, Number of individual labels: 16

Cable marker - LS-WMTB-AL (60X15) BK - 0831510



Cable marker, Aluminum label, black, unlabeled, can be labeled with: TOPMARK NEO, TOPMARK LASER, mounting type: Assembly with cable binders, cable diameter: > 4.6 mm, lettering field size: 60 x 15 mm, Number of individual labels: 16

Cable marker - LS-WMTB-AL (100X15) - 0831503



Cable marker, Aluminum label, aluminum color, unlabeled, can be labeled with: TOPMARK NEO, TOPMARK LASER, mounting type: Assembly with cable binders, cable diameter: > 4.6 mm, lettering field size: 100 x 15 mm, Number of individual labels: 8

Cable marker - LS-WMTB-AL (100X15) BK - 0831511



Cable marker, Aluminum label, black, unlabeled, can be labeled with: TOPMARK NEO, TOPMARK LASER, mounting type: Assembly with cable binders, cable diameter: > 4.6 mm, lettering field size: 100 x 15 mm, Number of individual labels: 8

Cable marker - WMTB HF (40X12)R YE - 0830408



Cable marker, Roll, yellow, unlabeled, can be labeled with: THERMOMARK ROLLMASTER 300/600, THERMOMARK X1.2, THERMOMARK ROLL X1, THERMOMARK ROLL 2.0, THERMOMARK ROLL, mounting type: Assembly with cable binders, cable diameter: \geq 6 mm, lettering field size: 40 x 12 mm, Number of individual labels: 1000

Sensor/actuator cable - SAC-4P- 5,0-28R/FR SCO RAIL - 1407321

Accessories

Cable marker - WMTB HF (55X15)R YE - 0830410



Cable marker, Roll, yellow, unlabeled, can be labeled with: THERMOMARK ROLLMASTER 300/600, THERMOMARK X1.2, THERMOMARK ROLL X1, THERMOMARK ROLL 2.0, THERMOMARK ROLL, mounting type: Assembly with cable binders, cable diameter: ≥ 6 mm, lettering field size: 55 x 15 mm, Number of individual labels: 1000

Cable marker - WMTB HF (55X25)R YE - 0830412



Cable marker, Roll, yellow, unlabeled, can be labeled with: THERMOMARK ROLLMASTER 300/600, THERMOMARK X1.2, THERMOMARK ROLL X1, THERMOMARK ROLL 2.0, THERMOMARK ROLL, mounting type: Assembly with cable binders, cable diameter: ≥ 6 mm, lettering field size: 55 x 25 mm, Number of individual labels: 500

Conductor marking - UCT-WMCO 5,4 (23X8) - 0832105



Conductor marking, Sheet, white, unlabeled, can be labeled with: TOPMARK NEO, TOPMARK LASER, BLUEMARK ID COLOR, BLUEMARK ID, BLUEMARK CLED, THERMOMARK PRIME, THERMOMARK CARD 2.0, THERMOMARK CARD, mounting type: clip on, cable diameter range: 4.7 ... 5.4 mm, lettering field size: 23 x 8 mm, Number of individual labels: 18

Conductor marking - UCT-WMCO 6,1 (23X8) - 0832106



Conductor marking, Sheet, white, unlabeled, can be labeled with: TOPMARK NEO, TOPMARK LASER, BLUEMARK ID COLOR, BLUEMARK ID, BLUEMARK CLED, THERMOMARK PRIME, THERMOMARK CARD 2.0, THERMOMARK CARD, mounting type: clip on, cable diameter range: 5.4 ... 6.1 mm, lettering field size: 23 x 8 mm, Number of individual labels: 18

Conductor marking - UCT-WMCO 6,8 (23X8) - 0832107



Conductor marking, Sheet, white, unlabeled, can be labeled with: TOPMARK NEO, TOPMARK LASER, BLUEMARK ID COLOR, BLUEMARK ID, BLUEMARK CLED, THERMOMARK PRIME, THERMOMARK CARD 2.0, THERMOMARK CARD, mounting type: clip on, cable diameter range: 6.1 ... 6.8 mm, lettering field size: 23 x 8 mm, Number of individual labels: 15

Sensor/actuator cable - SAC-4P- 5,0-28R/FR SCO RAIL - 1407321

Accessories

Conductor marking - UCT-WMCO 7,5 (23X8) - 0832108



Conductor marking, Sheet, white, unlabeled, can be labeled with: TOPMARK NEO, TOPMARK LASER, BLUEMARK ID COLOR, BLUEMARK ID, BLUEMARK CLED, THERMOMARK PRIME, THERMOMARK CARD 2.0, THERMOMARK CARD, mounting type: clip on, cable diameter range: 6.8 ... 7.5 mm, lettering field size: 23 x 8 mm, Number of individual labels: 15

Cable marker - WMTB-AL (40X15) - 0830524



Cable marker, Aluminum label, aluminum color, unlabeled, can be labeled with: BLUEMARK ID COLOR, BLUEMARK ID, BLUEMARK CLED, mounting type: Assembly with cable binders, cable diameter: > 4.6 mm, lettering field size: 40 x 15 mm

Cable marker - WMTB-AL (60X15) - 0830525



Cable marker, Aluminum label, aluminum color, unlabeled, can be labeled with: BLUEMARK ID COLOR, BLUEMARK ID, BLUEMARK CLED, mounting type: Assembly with cable binders, cable diameter: > 4.6 mm, lettering field size: 60 x 15 mm

Cable marker - LS-WMTB-AL (40X15) - 0831501



Cable marker, Aluminum label, aluminum color, unlabeled, can be labeled with: TOPMARK NEO, TOPMARK LASER, mounting type: Assembly with cable binders, cable diameter: > 4.6 mm, lettering field size: 40 x 15 mm, Number of individual labels: 16

Cable marker - LS-WMTB-AL (40X15) BK - 0831509



Cable marker, Aluminum label, black, unlabeled, can be labeled with: TOPMARK NEO, TOPMARK LASER, mounting type: Assembly with cable binders, cable diameter: > 4.6 mm, lettering field size: 40 x 15 mm, Number of individual labels: 16

Sensor/actuator cable - SAC-4P- 5,0-28R/FR SCO RAIL - 1407321

Accessories

Cable marker - LS-WMTB-AL (60X15) - 0831502

Cable marker, Aluminum label, aluminum color, unlabeled, can be labeled with: TOPMARK NEO, TOPMARK LASER, mounting type: Assembly with cable binders, cable diameter: > 4.6 mm, lettering field size: 60 x 15 mm, Number of individual labels: 16



Cable marker - LS-WMTB-AL (60X15) BK - 0831510

Cable marker, Aluminum label, black, unlabeled, can be labeled with: TOPMARK NEO, TOPMARK LASER, mounting type: Assembly with cable binders, cable diameter: > 4.6 mm, lettering field size: 60 x 15 mm, Number of individual labels: 16



Cable marker - LS-WMTB-AL (100X15) - 0831503

Cable marker, Aluminum label, aluminum color, unlabeled, can be labeled with: TOPMARK NEO, TOPMARK LASER, mounting type: Assembly with cable binders, cable diameter: > 4.6 mm, lettering field size: 100 x 15 mm, Number of individual labels: 8



Cable marker - LS-WMTB-AL (100X15) BK - 0831511

Cable marker, Aluminum label, black, unlabeled, can be labeled with: TOPMARK NEO, TOPMARK LASER, mounting type: Assembly with cable binders, cable diameter: > 4.6 mm, lettering field size: 100 x 15 mm, Number of individual labels: 8



Cutting tools

Cable-cutting tool - CUTFOX 12 - 1212128



Cable cutter, for copper and aluminum up to 12 mm diameter (up to 35 mm²)

Sensor/actuator cable - SAC-4P- 5,0-28R/FR SCO RAIL - 1407321

Accessories

Diagonal cutter - CUTFOX-S VDE - 1212207



Diagonal cutter for hard (piano wire) and soft wires, VDE 1000 V AC/1500 V DC tested

Electronics pliers

Diagonal cutter - MICROFOX-SP-1 - 1212487



Electronic diagonal cutter, tapered head, without chamfer, with opening spring, non-reflective phosphate-treated surface, punched version

Marker carrier cable

Conductor marker carrier - PATG HF 3/18 - 1014059



Conductor marker carrier, transparent/black, unlabeled, mounting type: slide-on, cable diameter range: 4 ... 7 mm, lettering field size: 18 x 4 mm

Conductor marker carrier - PATG HF 3/23 - 1014060



Conductor marker carrier, transparent/black, unlabeled, mounting type: slide-on, cable diameter range: 4 ... 7 mm, lettering field size: 23 x 4 mm

Conductor marker carrier - PATG HF 3/30 - 1014061



Conductor marker carrier, transparent/black, unlabeled, mounting type: slide-on, cable diameter range: 4 ... 7 mm, lettering field size: 30 x 4 mm

Sensor/actuator cable - SAC-4P- 5,0-28R/FR SCO RAIL - 1407321

Accessories

Conductor marker carrier - PATG HF 4/18 - 1014065



Conductor marker carrier, transparent/black, unlabeled, mounting type: slide-on, cable diameter range: 5 ... 10 mm, lettering field size: 18 x 4 mm

Conductor marker carrier - PATG HF 4/23 - 1014066



Conductor marker carrier, transparent/black, unlabeled, mounting type: slide-on, cable diameter range: 5 ... 10 mm, lettering field size: 23 x 4 mm

Conductor marker carrier - PATG HF 4/30 - 1014067



Conductor marker carrier, transparent/black, unlabeled, mounting type: slide-on, cable diameter range: 5 ... 10 mm, lettering field size: 30 x 4 mm

Cable marker carrier - KMK HP (25X6) - 0830720



Cable marker carrier, transparent, unlabeled, mounting type: Assembly with cable binders, cable diameter: ≥ 6 mm, lettering field size: 25 mm x 6 mm

Cable marker carrier - KMK HP (29X8) - 0830721



Cable marker carrier, transparent, unlabeled, mounting type: Assembly with cable binders, cable diameter: ≥ 6 mm, lettering field size: 29 x 8 mm

Sensor/actuator cable - SAC-4P- 5,0-28R/FR SCO RAIL - 1407321

Accessories

Cable marker carrier - KMK HP (25X6) - 0830720



Cable marker carrier, transparent, unlabeled, mounting type: Assembly with cable binders, cable diameter: ≥ 6 mm, lettering field size: 25 mm x 6 mm

Cable marker carrier - KMK HP (29X8) - 0830721



Cable marker carrier, transparent, unlabeled, mounting type: Assembly with cable binders, cable diameter: ≥ 6 mm, lettering field size: 29 x 8 mm

Marker pen

Marker pen - B-STIFT - 1051993



Marker pen, for manual labeling of unprinted Zack strips, smear-proof and waterproof, line thickness 0.5 mm

Marker pen - B-STIFT - 1051993



Marker pen, for manual labeling of unprinted Zack strips, smear-proof and waterproof, line thickness 0.5 mm

Plug for cable screw gland

Screw plug - PROT-M12 MS-PA-CHAIN - 1430899



M12 sealing cap with fixing band, for sensor cables, for free M12 sockets

Safety locking

Sensor/actuator cable - SAC-4P- 5,0-28R/FR SCO RAIL - 1407321

Accessories

Locking clip - SAC-M12-EXCLIP-F - 1558991



Locking clip for the socket side of sensor/actuator cables with M12 connector and M12 connectors for assembly, for knurl diameter: 15 mm or for Allen key with a wrench size of 14 mm, prevents the disconnection of plug-in connections without tools

Screwdriver tools

Adapter insert - TSD-M SAC-BIT ADAPTER - 1212600



Adapter bit for TSD-M...torque tools, E6.3-1/4" drive with 4 mm hexagon to accommodate SAC bits

Tool - SAC BIT M12-D15 - 1208432



Nut for assembling sensor/actuator cables with M12 connector and M12 connectors for assembly, with a knurl diameter of 15 mm, for 4 mm hexagonal drive

Sensor/actuator cable

Sensor/actuator cable - SAC-4P-MS SCO RAIL/.../... - 1412169



Sensor/actuator cable, 4-position, Variable cable type, shielded, Plug straight M12 SPEEDCON, coding: A, on free cable end, cable length: Free input (0.2 ... 40.0 m), For railway applications

Sensor/actuator cable - SAC-4P-MR SCO RAIL/.../... - 1412170



Sensor/actuator cable, 4-position, Variable cable type, shielded, Plug angled M12 SPEEDCON, coding: A, on free cable end, cable length: Free input (0.2 ... 40.0 m), For railway applications

Sensor/actuator cable - SAC-4P- 5,0-28R/FR SCO RAIL - 1407321

Accessories

Sensor/actuator cable - SAC-4P-FS SCO RAIL/.../... - 1412167



Sensor/actuator cable, 4-position, Variable cable type, shielded, free cable end, on Socket straight M12 SPEEDCON, coding: A, cable length: Free input (0.2 ... 40.0 m), For railway applications

Sensor/actuator cable - SAC-4P-FR SCO RAIL/.../... - 1412168



Sensor/actuator cable, 4-position, Variable cable type, shielded, free cable end, on Socket angled M12 SPEEDCON, coding: A, cable length: Free input (0.2 ... 40.0 m), For railway applications

Sensor/actuator cable - SAC-4P-MS-FS SCO RAIL/.../... - 1412171



Sensor/actuator cable, 4-position, Variable cable type, shielded, Plug straight M12 SPEEDCON, coding: A, on Socket straight M12 SPEEDCON, coding: A, cable length: Free input (0.2 ... 40.0 m), For railway applications

Shrink sleeve

Shrink sleeve - WMS-2 HF 6,4 (60X10)RL YE - 0801025



Shrink sleeve, Roll, yellow, can be labeled with: THERMOMARK ROLLMASTER 300/600, THERMOMARK X1.2, THERMOMARK ROLL X1, THERMOMARK ROLL 2.0, THERMOMARK ROLL: without print, Cut, mounting type: slide-on, cable diameter range: 3.2 ... 6.4 mm, lettering field size: 60 x 10 mm, Number of individual labels: 1000

Shrink sleeve - WMS-2 HF 6,4 (EX10)RL YE - 0833244



Shrink sleeve, Roll, yellow, can be labeled with: THERMOMARK ROLLMASTER 300/600, THERMOMARK X1.2, THERMOMARK ROLL X1, THERMOMARK ROLL 2.0, THERMOMARK ROLL, THERMOMARK W: without print, Cut, mounting type: slide-on, cable diameter range: 3.2 ... 6.4 mm, lettering field size: 10 x 100000 mm

Sensor/actuator cable - SAC-4P- 5,0-28R/FR SCO RAIL - 1407321

Accessories

Shrink sleeve - WMS-2 HF 9,5 (60X16)RL YE - 0801029



Shrink sleeve, Roll, yellow, can be labeled with: THERMOMARK ROLLMASTER 300/600, THERMOMARK X1.2, THERMOMARK ROLL X1, THERMOMARK ROLL 2.0, THERMOMARK ROLL: without print, Cut, mounting type: slide-on, cable diameter range: 4.8 ... 9.5 mm, lettering field size: 60 x 16 mm, Number of individual labels: 500

Shrink sleeve - WMS-2 HF 9,5 (EX16)RL YE - 0833245



Shrink sleeve, Roll, yellow, can be labeled with: THERMOMARK ROLLMASTER 300/600, THERMOMARK X1.2, THERMOMARK ROLL X1, THERMOMARK ROLL 2.0, THERMOMARK ROLL, THERMOMARK W: without print, Cut, mounting type: slide-on, cable diameter range: 4.8 ... 9.5 mm, lettering field size: continuous x 16 mm

Stripping tool

Stripping tool - WIREFOX 4 - 1212156



Stripping tool, for cables and conductors (especially for rubber and silicone insulations) from 0.1 - 4 mm², self-adjusting, stripping length of up to 18 mm, cutting capacity of up to 10 mm² stranded/1.5 mm² solid, replaceable stripping blade

Stripping tool - WIREFOX-E 4 - 1212704



Stripping tool, for cables and conductors (especially for rubber and silicone insulations) from 0.1 - 4 mm², self-adjusting, stripping length of up to 18 mm, cutting capacity of up to 10 mm² stranded/1.5 mm² solid, replaceable stripping blade

Stripping tool - WIREFOX 10 - 1212150



Stripping tool, for cables and conductors from 0.02 - 10 mm², self-adjusting, stripping length of up to 18 mm, cutting capacity of up to 10 mm² stranded/1.5 mm² solid, replaceable stripping blade

Torque tool

Sensor/actuator cable - SAC-4P- 5,0-28R/FR SCO RAIL - 1407321

Accessories

Torque screwdriver - TSD 04 SAC - 1208429



Torque screwdriver, with preset torque of 0.4 Nm and 4 mm hexagonal drive for M12 connectors

Torque screwdriver - TSD-M 1,2NM - 1212224



Torque screw driver, accuracy as per EN ISO 6789 standard, adjustable from 0.3 - 1.2 Nm

Phoenix Contact 2020 © - all rights reserved
<http://www.phoenixcontact.com>

PHOENIX CONTACT GmbH & Co. KG
Flachsmarktstr. 8
32825 Blomberg
Germany
Tel. +49 5235 300
Fax +49 5235 3 41200
<http://www.phoenixcontact.com>