

Sensor/actuator cable - SAC-8P-M12MS/ 2,0-28X/M12FS OD - 1407277

Please be informed that the data shown in this PDF Document is generated from our Online Catalog. Please find the complete data in the user's documentation. Our General Terms of Use for Downloads are valid (<http://phoenixcontact.com/download>)



Sensor/actuator cable, 8-position, PE-X halogen-free, black-gray RAL 7021, Plug straight M12, coding: A, on Socket straight M12, coding: A, cable length: 2 m, for outdoor applications, with high-grade steel knurl

Your advantages

- ✓ Easy and safe: 100% electrically tested plug-in components
- ✓ Corrosion protection for all exposed metal parts, thanks to the use of stainless steel type 1.4404
- ✓ Robust throughout: resistant to oil, UV, and ozone, withstands temperatures from -40°C to +105°C

Key Commercial Data

Packing unit	1 pc
GTIN	 4 046356 773959
GTIN	4046356773959

Technical data

Dimensions

Length of cable	2 m
-----------------	-----

Ambient conditions

Ambient temperature (operation)	-40 °C ... 105 °C (Plug / socket)
	-40 °C ... 85 °C (On sudden changes in temperature (according to IEC 60512-11-4))
Degree of protection	IP65
	IP67
	IP68
	IP69K

General

Rated current at 40°C	2 A
Rated voltage	30 V AC
	30 V DC

Sensor/actuator cable - SAC-8P-M12MS/ 2,0-28X/M12FS OD - 1407277

Technical data

General

Number of positions	8
Insulation resistance	≥ 100 MΩ
Coding	A - standard
Standards/regulations	M12 connector IEC 61076-2-101
Status display	No
Protective circuit/component	unwired
Degree of pollution	3
Insertion/withdrawal cycles	≥ 100
Torque	0.4 Nm (M12 connector)

Material

Flammability rating according to UL 94	V0
Contact material	CuSn
Contact surface material	Ni/Au
Contact carrier material	PP
Material of grip body	PP
Material, knurls	Stainless steel
Sealing material	FPM

Standards and Regulations

Standards/specifications	M12 connector IEC 61076-2-101
Flammability rating according to UL 94	V0

Cable

Cable type	PE-X black
Cable type (abbreviation)	28X
Cable abbreviation	Li2X2X
Conductor cross section	8x 0.25 mm ²
AWG signal line	24
Conductor structure signal line	32x 0.10 mm
Core diameter including insulation	1.17 mm ±0.02 mm
Thickness, insulation	approx. 0.25 mm (Core insulation)
Wire colors	white, brown, green, yellow, gray, pink, blue, red
Overall twist	8 wires around filler to the core
Length of twist, overall twist	67 mm
External sheath, color	black-gray RAL 7021
Outer sheath thickness	approx. 1.3 mm
External cable diameter D	6.8 mm ±0.2 mm
Minimum bending radius, fixed installation	5 x D
Minimum bending radius, flexible installation	10 x D
Number of bending cycles	2000000
Minimum bending radius, drag chain applications	10 x D

Sensor/actuator cable - SAC-8P-M12MS/ 2,0-28X/M12FS OD - 1407277

Technical data

Cable

Traversing path	10 m
Traversing rate	3 m/s
Acceleration	10 m/s ²
Cable weight	65 kg/km
Outer sheath, material	PE-X
Material, filler	PP yarn
Material conductor insulation	PE-X
Conductor material	Bare Cu litz wires
Insulation resistance	≥ 100 MΩ*km (at 20 °C)
Conductor resistance	≤ 78 Ω/km (at 20 °C)
Nominal voltage, cable	≤ 300 V AC
Test voltage, cable	≥ 3000 V AC (Spark test)
Special properties	Irradiated
Flame resistance	According to DIN EN 60332-1-2
	according to DIN EN 50266-2-5
Halogen-free	in accordance with DIN VDE 0472 part 815
	in accordance with DIN EN 50267-2-1
Resistance to oil	According to DIN EN 60811-2-1, 168 h at 100°C
	According to DIN EN 50306
Other resistance	Resistance to fuels according to IEC 60811, 168 h at 70°C
	UV resistant according to DIN VDE 0276-605
Ambient temperature (operation)	-40 °C ... 105 °C (cable, fixed installation)
	-15 °C ... 105 °C (cable, flexible installation)
	20 °C ±5 °C (cable, drag chain applications)

Environmental Product Compliance

REACH SVHC	Lead 7439-92-1
China RoHS	Environmentally Friendly Use Period = 50 years
	For details about hazardous substances go to tab "Downloads", Category "Manufacturer's declaration"

Drawings

Sensor/actuator cable - SAC-8P-M12MS/ 2,0-28X/M12FS OD - 1407277

Schematic diagram

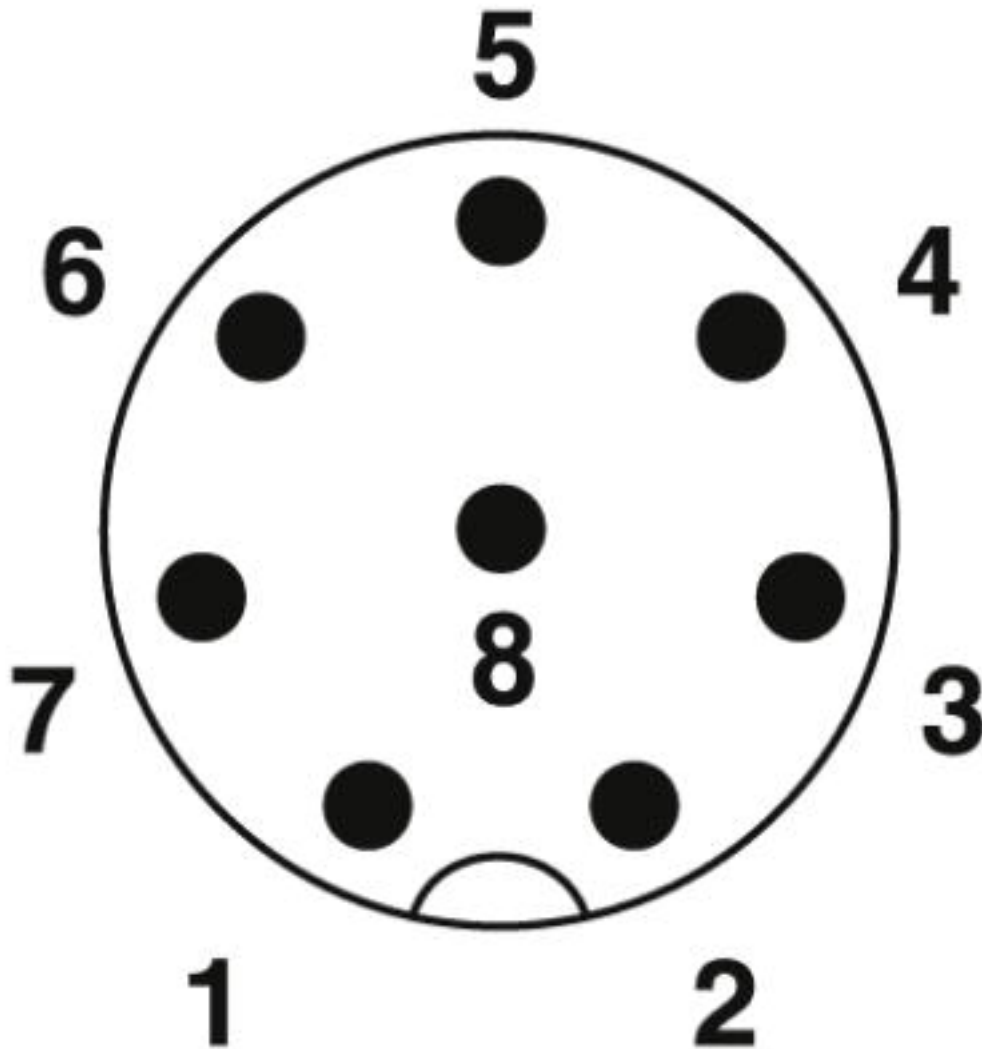

Pin assignment M12 plug, 8-pos., A-coded, view plug side

Sensor/actuator cable - SAC-8P-M12MS/ 2,0-28X/M12FS OD - 1407277

Schematic diagram

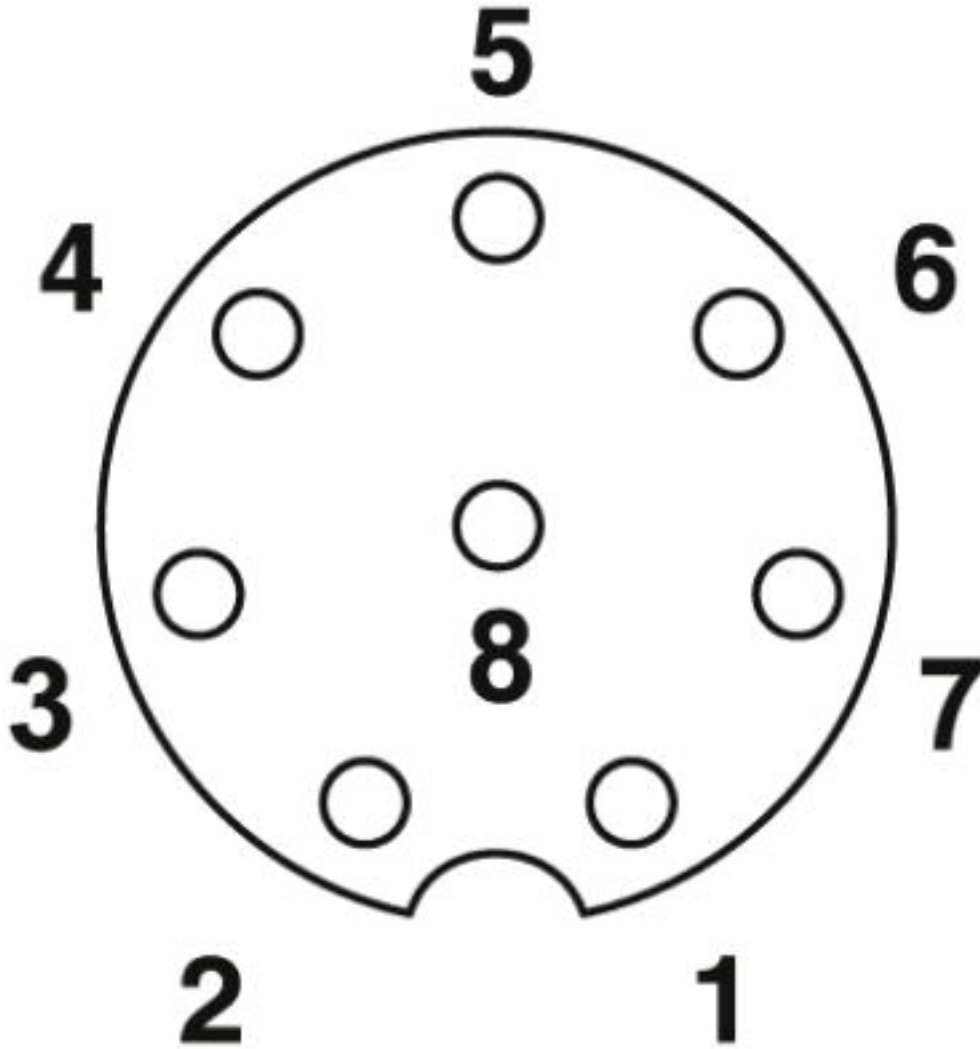

Pin assignment M12 socket, 8-pos., A-coded, view female side

Sensor/actuator cable - SAC-8P-M12MS/ 2,0-28X/M12FS OD - 1407277

Dimensional drawing

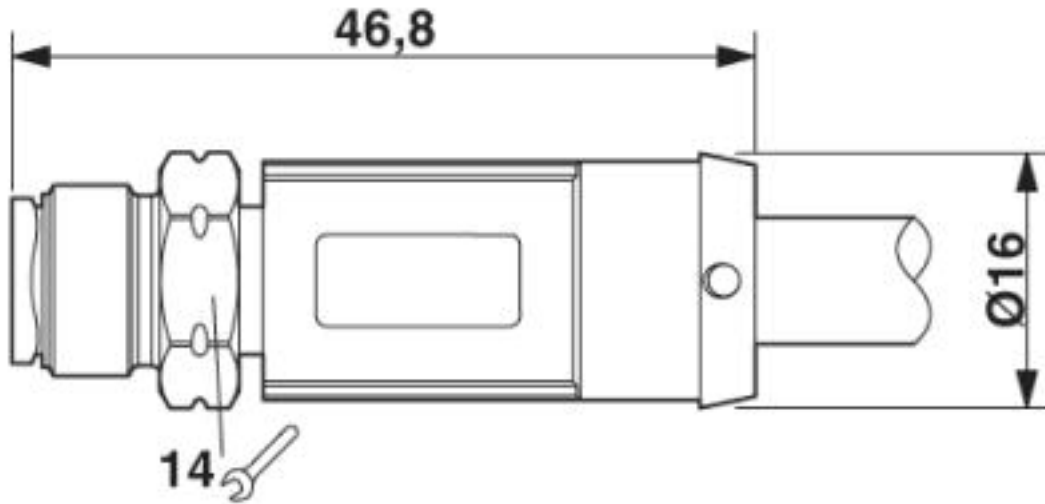

Plug, M12 x 1, straight, shielded

Dimensional drawing

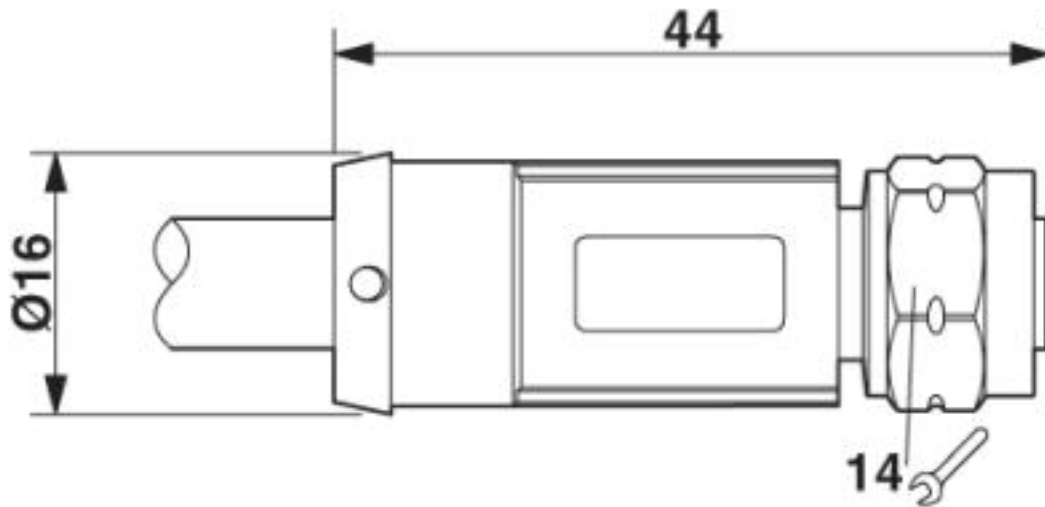

M12 x 1 socket, straight

Sensor/actuator cable - SAC-8P-M12MS/ 2,0-28X/M12FS OD - 1407277

Circuit diagram

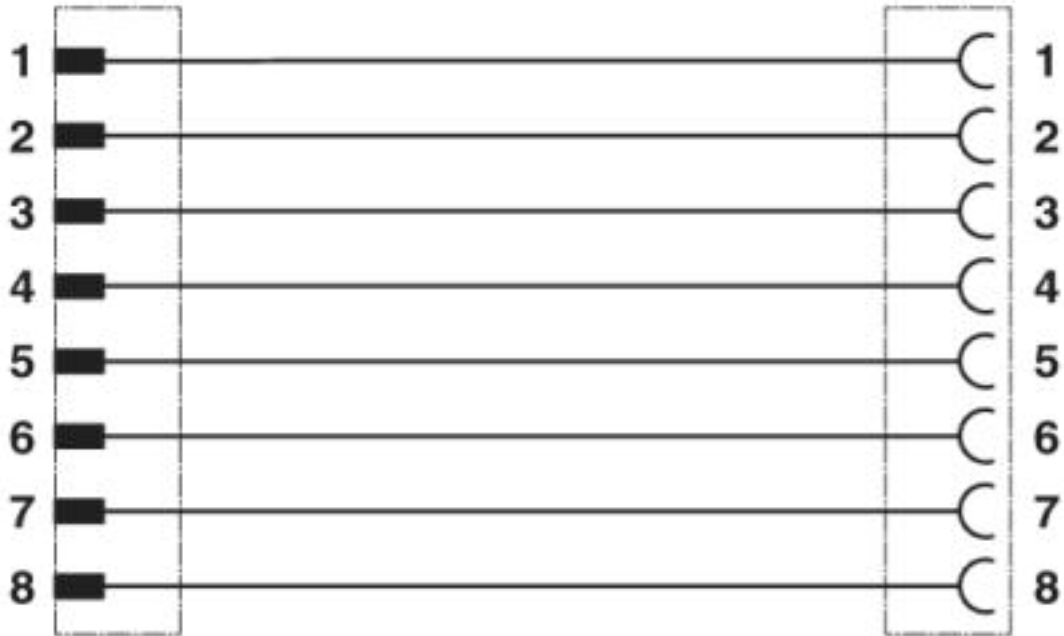

Contact assignment of the M12 connector and the M12 socket

Sensor/actuator cable - SAC-8P-M12MS/ 2,0-28X/M12FS OD - 1407277

Cable cross section



PE-X black [28X]

Classifications

eCl@ss

eCl@ss 10.0.1	27060311
eCl@ss 4.0	27060300
eCl@ss 4.1	27060300
eCl@ss 5.0	27061800
eCl@ss 5.1	27061800
eCl@ss 6.0	27279200
eCl@ss 7.0	27279218
eCl@ss 8.0	27279218
eCl@ss 9.0	27060311

Sensor/actuator cable - SAC-8P-M12MS/ 2,0-28X/M12FS OD - 1407277

Classifications

ETIM

ETIM 3.0	EC001855
ETIM 4.0	EC001855
ETIM 5.0	EC001855
ETIM 6.0	EC001855
ETIM 7.0	EC001855

UNSPSC

UNSPSC 6.01	31251501
UNSPSC 7.0901	31251501
UNSPSC 11	31251501
UNSPSC 12.01	31251501
UNSPSC 13.2	31251501
UNSPSC 19.0	31251501
UNSPSC 20.0	31251501
UNSPSC 21.0	31251501

Approvals

Approvals

Approvals

DNV GL

Ex Approvals

Approval details

DNV GL		https://approvalfinder.dnvgl.com/	TAE00002K4
--------	--	---	------------

Accessories

Accessories

Screwdriver tools

Sensor/actuator cable - SAC-8P-M12MS/ 2,0-28X/M12FS OD - 1407277

Accessories

Adapter insert - TSD-M SAC-BIT ADAPTER - 1212600



Adapter bit for TSD-M...torque tools, E6.3-1/4" drive with 4 mm hexagon to accommodate SAC bits

Adapter - SAC BIT M12-W14 - 1212513



Nut for assembling sensor/actuator cables with M12 connector and M12 connectors for assembly, with a hexagonal knurl wrench size of 14 mm, with 4 mm hexagonal drive

Torque tool

Torque screwdriver - TSD 04 SAC - 1208429



Torque screwdriver, with preset torque of 0.4 Nm and 4 mm hexagonal drive for M12 connectors

Torque screwdriver - TSD-M 1,2NM - 1212224



Torque screw driver, accuracy as per EN ISO 6789 standard, adjustable from 0.3 - 1.2 Nm

Phoenix Contact 2020 © - all rights reserved
<http://www.phoenixcontact.com>

PHOENIX CONTACT GmbH & Co. KG
Flachsmarktstr. 8
32825 Blomberg
Germany
Tel. +49 5235 300
Fax +49 5235 3 41200
<http://www.phoenixcontact.com>