

## Sensor/actuator cable - SAC-4P-MS/0,3-600/M 8FR-2L FB - 1406866

Please be informed that the data shown in this PDF Document is generated from our Online Catalog. Please find the complete data in the user's documentation. Our General Terms of Use for Downloads are valid (<http://phoenixcontact.com/download>)



Sensor/actuator cable, 4-position, PP-EPDM halogen-free, gray RAL 7035, Plug straight M8, on Socket angled M8, with 2 LEDs, cable length: 0.3 m, Hygienic design, with plastic knurl

### Your advantages

- ✓ Easy and safe: 100% electrically tested plug-in components
- ✓ Easy to clean, thanks to the special hygienic design
- ✓ Contamination can be detected quickly – thanks to the light color
- ✓ Convenient: increased machine availability thanks to quick and easy diagnostics

### Key Commercial Data

Packing unit	1 pc
GTIN	
GTIN	4046356781886

### Technical data

#### Dimensions

Length of cable	0.3 m
-----------------	-------

#### Ambient conditions

Ambient temperature (operation)	-40 °C ... 105 °C (Plug / socket)
Degree of protection	IP65
	IP67
	IP68
	IP69K

#### General

Rated current at 40°C	4 A
Rated voltage	24 V DC
Number of positions	4

# Sensor/actuator cable - SAC-4P-MS/0,3-600/M 8FR-2L FB - 1406866

## Technical data

### General

Insulation resistance	≥ 100 MΩ
Coding	A - standard
Standards/regulations	M8 connector IEC 61076-2-104
	Material conformance FDA 21 CFR 177.2600
Status display	2 LEDs
Protective circuit/component	unwired
Insertion/withdrawal cycles	≥ 100
Torque	0.2 Nm (M8 connectors)

### Material

Contact material	CuSn
Contact surface material	Ni/Au
Contact carrier material	PP
Material of grip body	PP
Material, knurls	Polypropylene
Sealing material	FKM

### Standards and Regulations

Standards/specifications	M8 connector IEC 61076-2-104
	Material conformance FDA 21 CFR 177.2600

### Cable

Cable type	Halogen-free PP gray
Cable type (abbreviation)	600
Cable abbreviation	Li9Y14Y
Conductor cross section	4x 0.25 mm <sup>2</sup> (Signal line)
AWG signal line	24
Conductor structure signal line	32x 0.10 mm
Core diameter including insulation	1.17 mm ±0.02 mm (Signal line)
Thickness, insulation	≥ 0.21 mm (Core insulation)
Wire colors	brown, white, blue, black
Overall twist	4 wires, twisted
Length of twist, overall twist	44 mm
External sheath, color	gray RAL 7035
Outer sheath thickness	approx. 0.8 mm
External cable diameter D	4.5 mm ±0.15 mm
Minimum bending radius, fixed installation	5 x D
Minimum bending radius, flexible installation	10 x D
Number of bending cycles	4000000
Minimum bending radius, drag chain applications	10 x D
Traversing path	10 m
Traversing rate	3 m/s

## Sensor/actuator cable - SAC-4P-MS/0,3-600/M 8FR-2L FB - 1406866

### Technical data

#### Cable

Acceleration	10 m/s <sup>2</sup>
Torsion force	± 270 °/m (4,000,000 torsion cycles, max. 25 torsion cycles/min)
Cable weight	23 kg/km
Outer sheath, material	PP-EPDM
Material conductor insulation	PP
Conductor material	Bare Cu litz wires
Insulation resistance	≥ 1 GΩ*km (at 20 °C)
Conductor resistance	78 Ω/km (at 20 °C)
Nominal voltage, cable	≤ 300 V AC
Test voltage, cable	≥ 3000 V AC (Spark test)
Special properties	FDA compliant according to FDA 21 CFR 177.2600
	highly flexible
	Flexible cable conduit capable
Halogen-free	in accordance with DIN VDE 0472 part 815
	in accordance with DIN EN 50267-2-1
Other resistance	Resistant to cold bending and cold impacts According to DIN EN 60811-1-4 (-40 °C)
Ambient temperature (operation)	-40 °C ... 105 °C (cable, fixed installation)
	-25 °C ... 105 °C (cable, flexible installation)

#### Environmental Product Compliance

China RoHS	Environmentally friendly use period: unlimited = EFUP-e
	No hazardous substances above threshold values

#### Drawings

# Sensor/actuator cable - SAC-4P-MS/0,3-600/M 8FR-2L FB - 1406866

Dimensional drawing

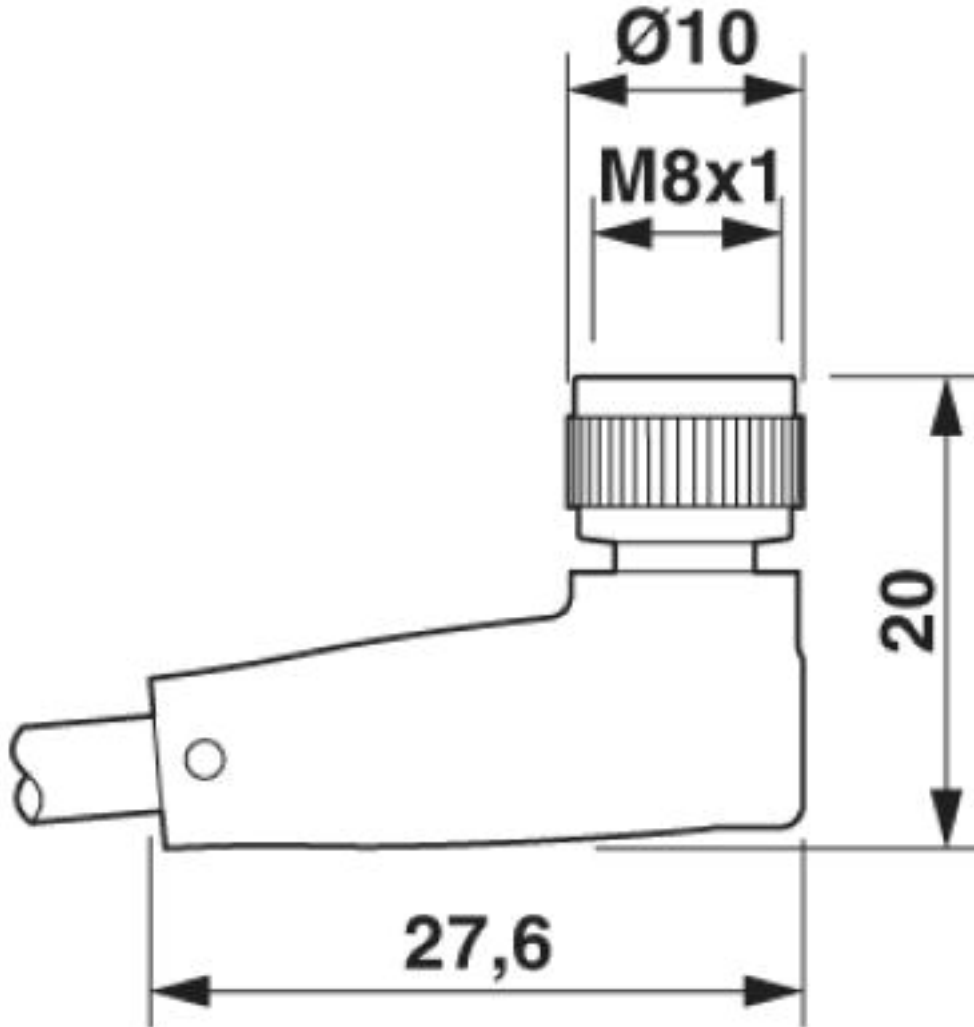

Socket M8 x 1, angled

Dimensional drawing

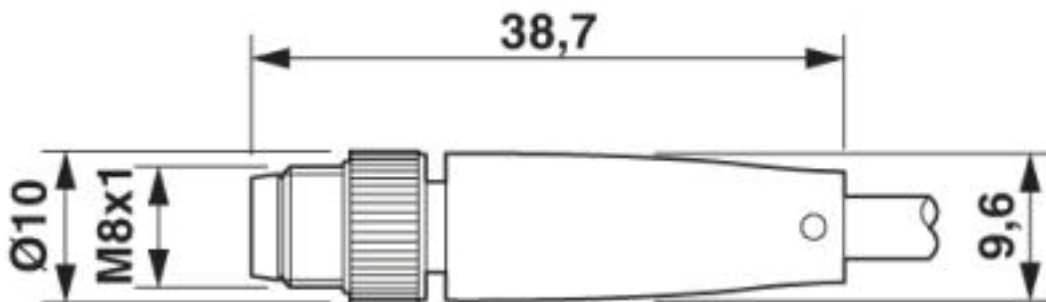

M8 x 1 male plug, straight version

# Sensor/actuator cable - SAC-4P-MS/0,3-600/M 8FR-2L FB - 1406866

Circuit diagram

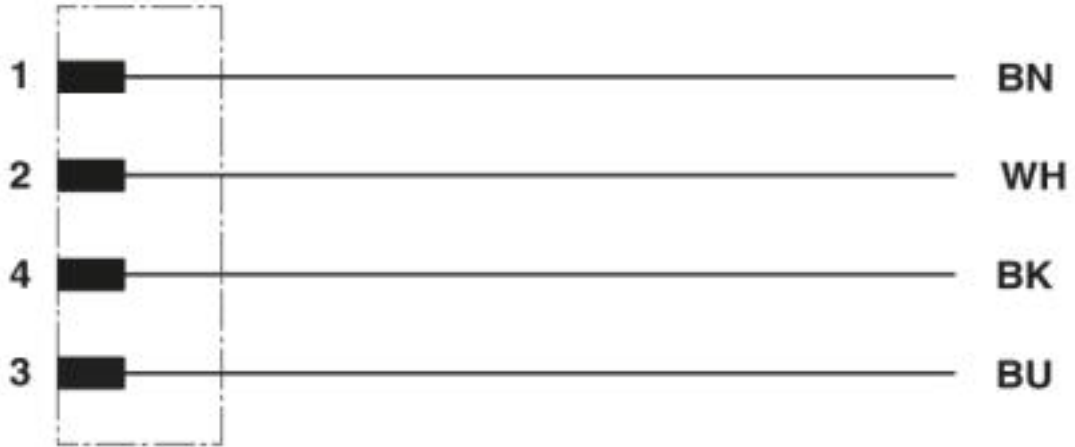

Contact assignment of the M12 plug

Circuit diagram

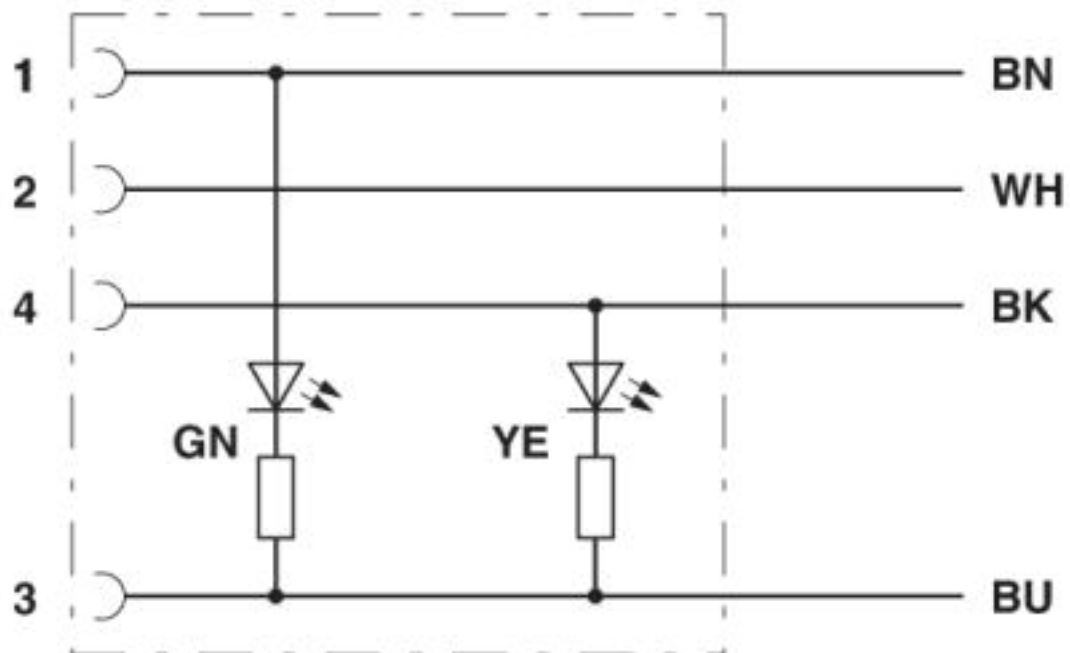

Contact assignment of the M8 socket with LED

# Sensor/actuator cable - SAC-4P-MS/0,3-600/M 8FR-2L FB - 1406866

Schematic diagram

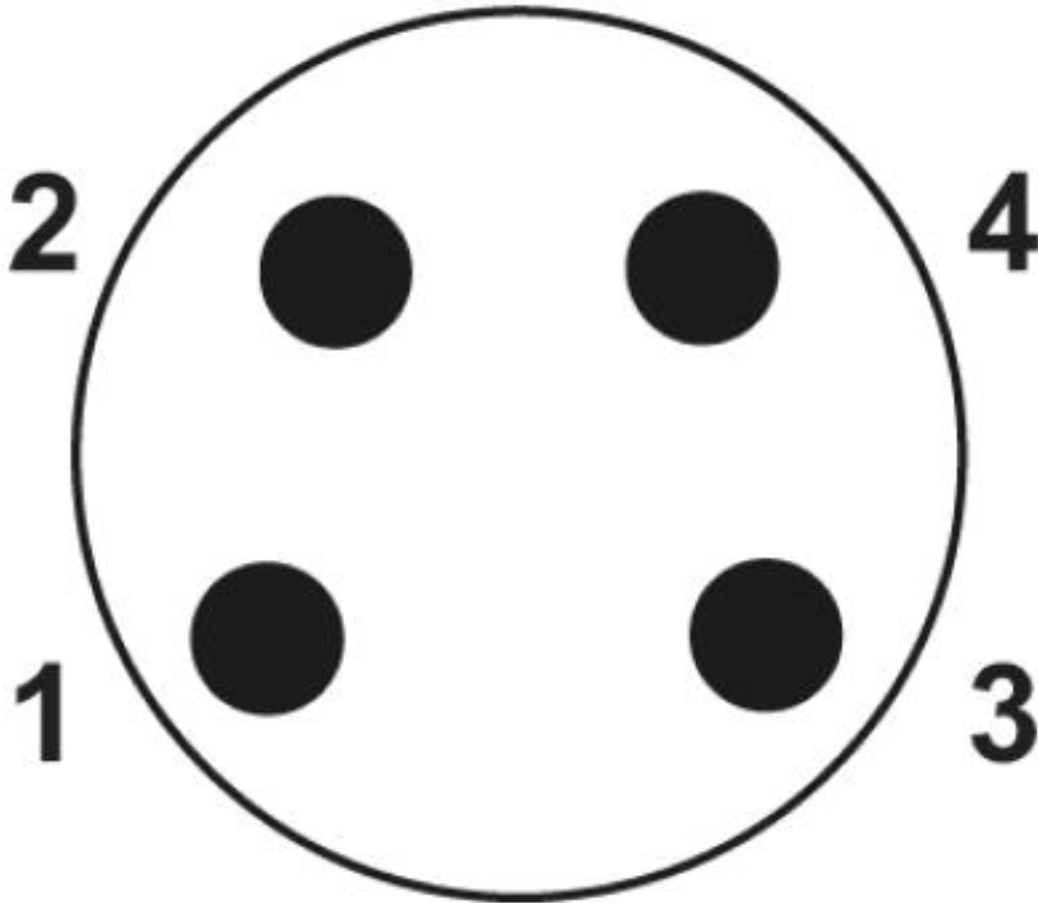

Pin assignment M8 plug, 4-pos., view male side

# Sensor/actuator cable - SAC-4P-MS/0,3-600/M 8FR-2L FB - 1406866

Schematic diagram

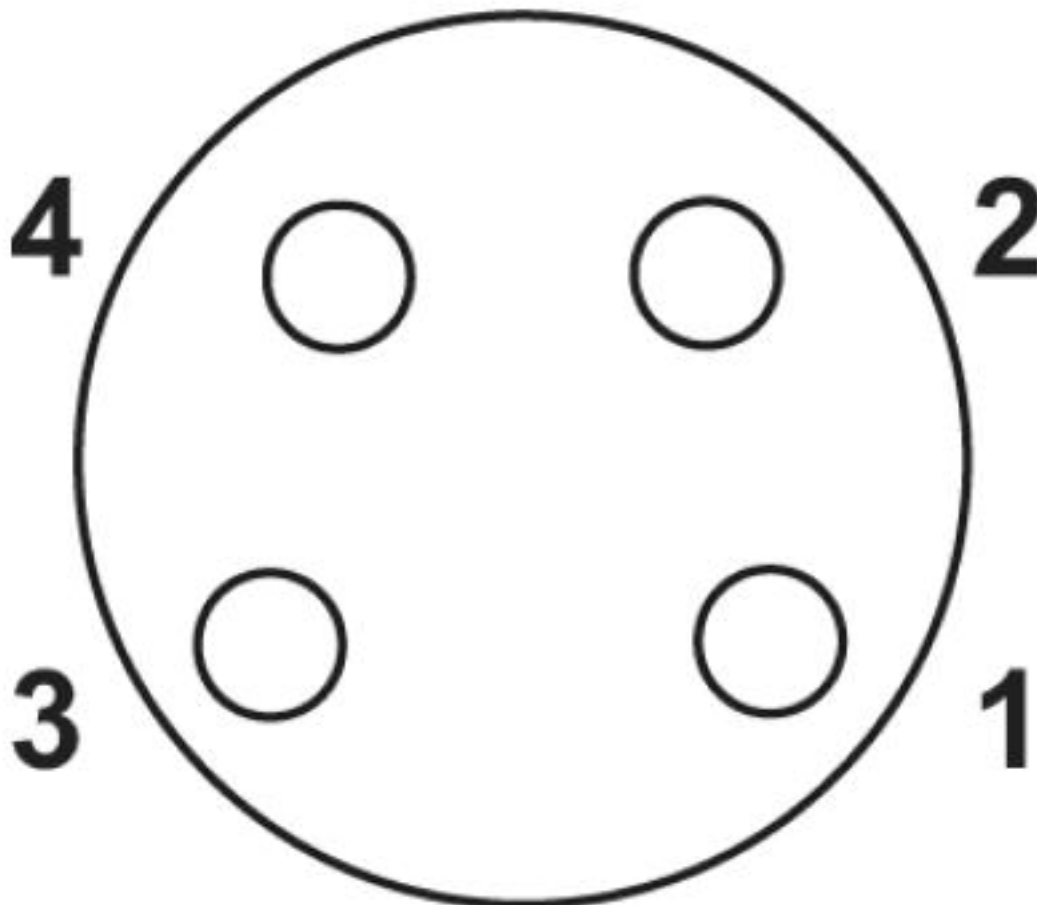

Pin assignment M8 socket, 4-pos., view female side

# Sensor/actuator cable - SAC-4P-MS/0,3-600/M 8FR-2L FB - 1406866

Cable cross section

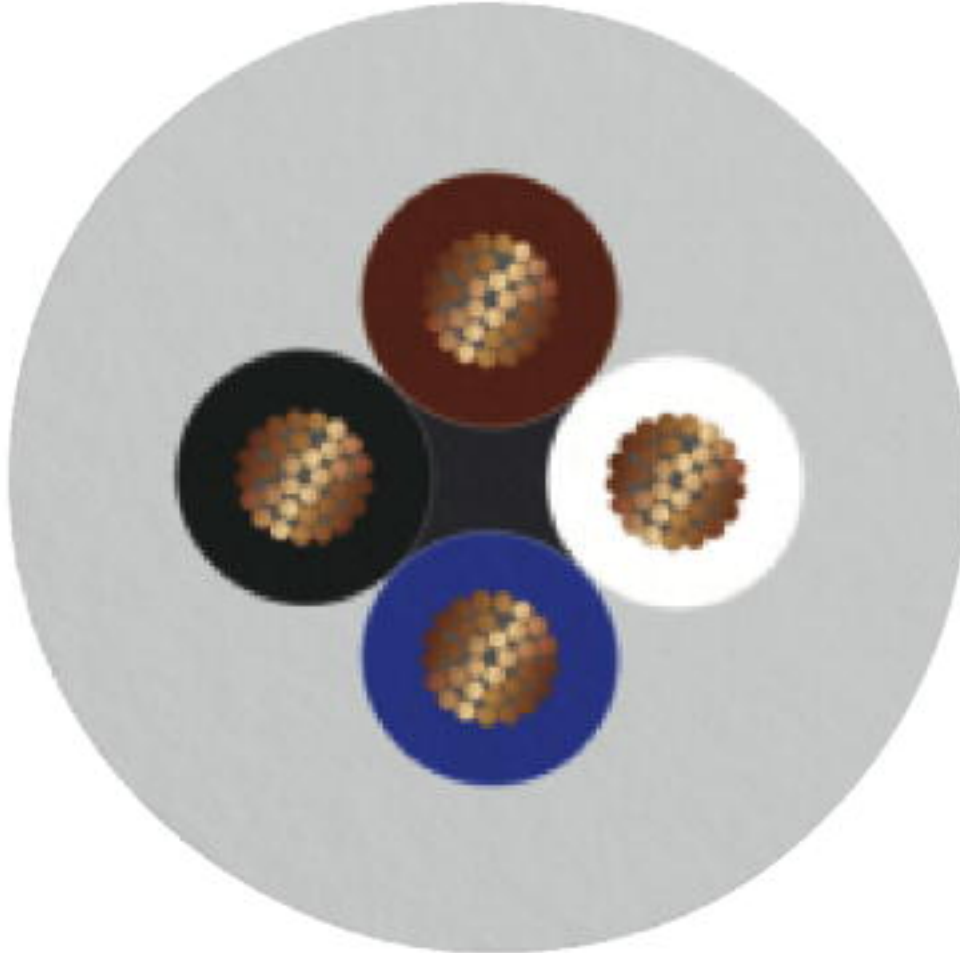

Halogen-free PP gray [600]

## Classifications

eCl@ss

eCl@ss 10.0.1	27060311
eCl@ss 4.0	27060300
eCl@ss 4.1	27060300
eCl@ss 5.0	27061800
eCl@ss 5.1	27061800
eCl@ss 6.0	27279200
eCl@ss 7.0	27279218
eCl@ss 8.0	27279218
eCl@ss 9.0	27060311



## Sensor/actuator cable - SAC-4P-MS/0,3-600/M 8FR-2L FB - 1406866

### Classifications

#### ETIM

ETIM 3.0	EC001855
ETIM 4.0	EC001855
ETIM 5.0	EC001855
ETIM 6.0	EC001855
ETIM 7.0	EC001855

#### UNSPSC

UNSPSC 6.01	31251501
UNSPSC 7.0901	31251501
UNSPSC 11	31251501
UNSPSC 12.01	31251501
UNSPSC 13.2	31251501
UNSPSC 19.0	31251501
UNSPSC 20.0	31251501
UNSPSC 21.0	31251501

Phoenix Contact 2020 © - all rights reserved  
<http://www.phoenixcontact.com>

PHOENIX CONTACT GmbH & Co. KG  
Flachsmarktstr. 8  
32825 Blomberg  
Germany  
Tel. +49 5235 300  
Fax +49 5235 3 41200  
<http://www.phoenixcontact.com>