

Sensor/actuator cable - SAC-3P-M12MR/ 1,5-542/M8FR BK - 1406307

Please be informed that the data shown in this PDF Document is generated from our Online Catalog. Please find the complete data in the user's documentation. Our General Terms of Use for Downloads are valid (<http://phoenixcontact.com/download>)



Sensor/actuator cable, 3-position, PVC, yellow, Plug angled M12, coding: A, on Socket angled M8, cable length: 1.5 m



Key Commercial Data

| | |
|------------------------|---------------------------------------------------------------------------------------------------------|
| Packing unit | 1 pc |
| Minimum order quantity | 50 pc |
| GTIN |  4 046356 797467 |
| GTIN | 4046356797467 |

Technical data

Dimensions

| | |
|-----------------|-------|
| Length of cable | 1.5 m |
|-----------------|-------|

Ambient conditions

| | |
|---------------------------------|----------------------------------|
| Ambient temperature (operation) | -25 °C ... 90 °C (Plug / socket) |
| Degree of protection | IP65 |
| | IP67 |
| | IP68 |

General

| | |
|-----------------------|-------------------------------|
| Rated current at 40°C | 4 A |
| Rated voltage | 48 V AC |
| | 60 V DC |
| Number of positions | 3 |
| Insulation resistance | ≥ 100 MΩ |
| Coding | A - standard |
| Standards/regulations | M12 connector IEC 61076-2-101 |
| | M8 connector IEC 61076-2-104 |
| Status display | No |

Sensor/actuator cable - SAC-3P-M12MR/ 1,5-542/M8FR BK - 1406307

Technical data

General

| | |
|------------------------------|------------------------|
| Protective circuit/component | unwired |
| Overvoltage category | II |
| Degree of pollution | 3 |
| Insertion/withdrawal cycles | ≥ 100 |
| Torque | 0.4 Nm (M12 connector) |
| | 0.2 Nm (M8 connectors) |

Material

| | |
|----------------------------------------|---------------------------------------------|
| Flammability rating according to UL 94 | HB |
| Contact material | CuSn |
| Contact surface material | Ni/Au |
| Contact carrier material | TPU GF |
| Material of grip body | TPU, hardly inflammable, self-extinguishing |
| Material, knurls | Zinc die-cast, nickel-plated |
| Sealing material | NBR |

Standards and Regulations

| | |
|----------------------------------------|-------------------------------|
| Standards/specifications | M12 connector IEC 61076-2-101 |
| | M8 connector IEC 61076-2-104 |
| Flammability rating according to UL 94 | HB |

Cable

| | |
|-----------------------------------------------|-----------------------------------------------|
| Cable type | PVC yellow 105 °C |
| Cable type (abbreviation) | 542 |
| UL AWM style | 2517 (105 °C / 300 V) |
| AWG signal line | 24 |
| Core diameter including insulation | 1.12 mm ±0.03 mm |
| Wire colors | brown, blue, black |
| Overall twist | 3 wires, twisted |
| External sheath, color | yellow |
| External cable diameter D | 4.1 mm ±0.2 mm |
| Minimum bending radius, flexible installation | 8 x D |
| Cable weight | 21 kg/km |
| Outer sheath, material | PVC |
| Material conductor insulation | PVC |
| Conductor material | Tin-plated Cu litz wires |
| Insulation resistance | ≥ (550 M Ohms/m @ 500V) |
| Conductor resistance | max. 79.7 Ω/km (20 °C) |
| Nominal voltage, cable | 300 V |
| Flame resistance | FT4 |
| Other resistance | UV resistant |
| Ambient temperature (operation) | -30 °C ... 105 °C (cable, fixed installation) |

Sensor/actuator cable - SAC-3P-M12MR/ 1,5-542/M8FR BK - 1406307

Technical data

Environmental Product Compliance

| | |
|------------|---------------------------------------------------------|
| China RoHS | Environmentally friendly use period: unlimited = EFUP-e |
| | No hazardous substances above threshold values |

Drawings

Dimensional drawing

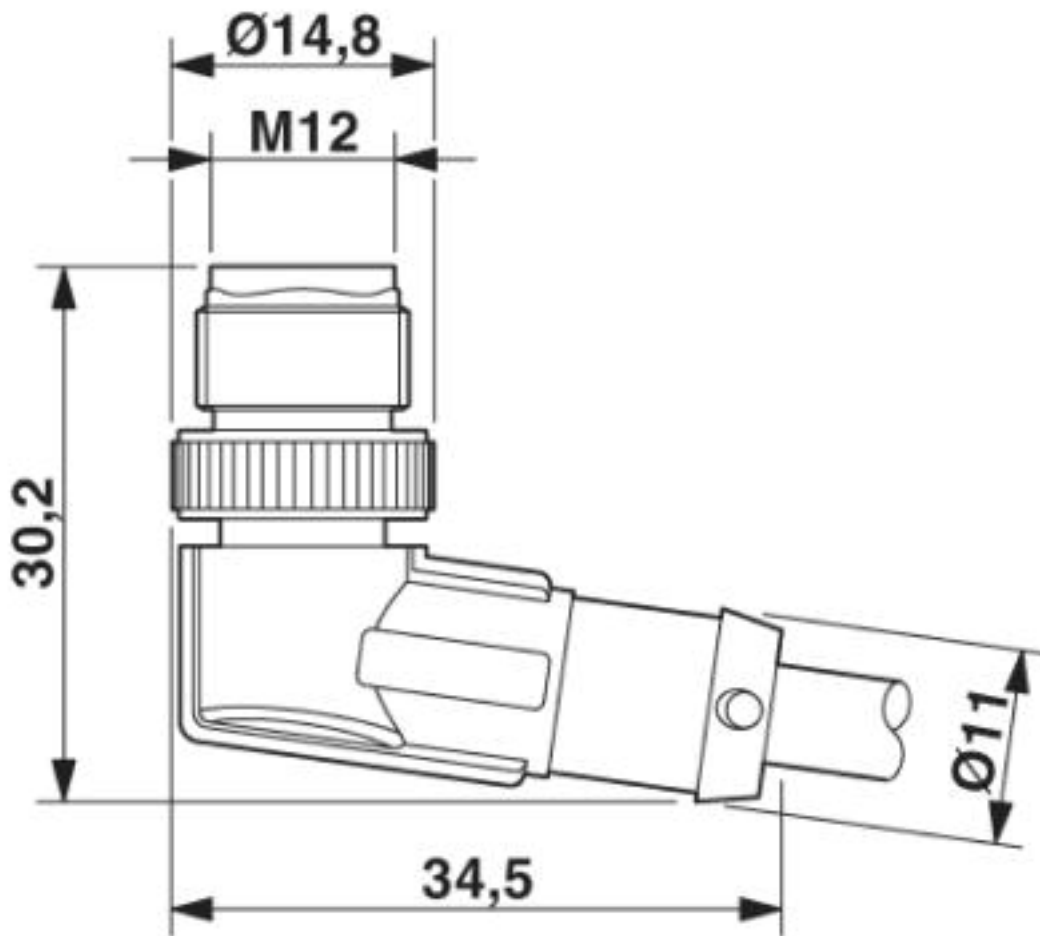

M12 x 1 male plug, angled

Sensor/actuator cable - SAC-3P-M12MR/ 1,5-542/M8FR BK - 1406307

Dimensional drawing

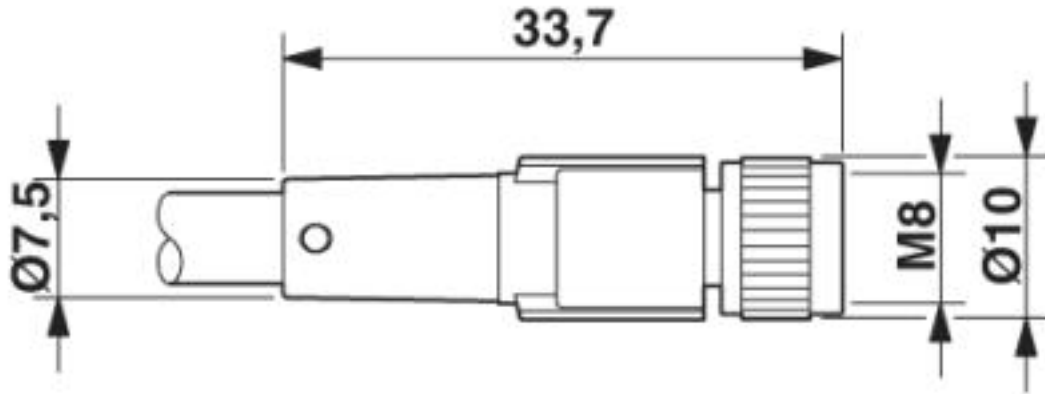

Socket M8 x 1, straight

Circuit diagram

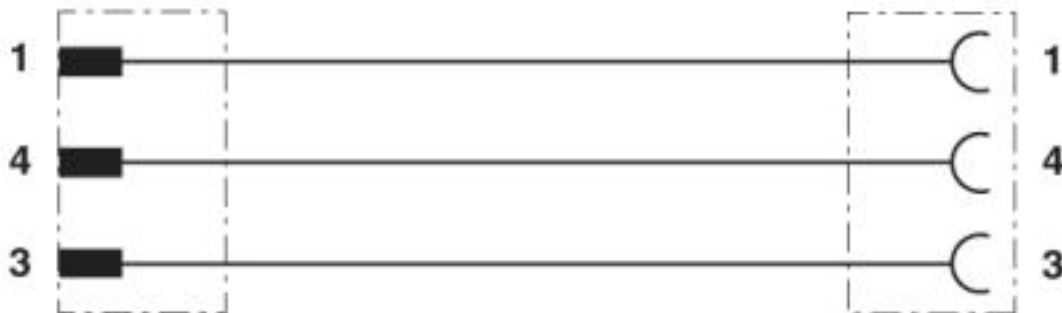

Contact assignment of M8 plugs / M12 sockets

Sensor/actuator cable - SAC-3P-M12MR/ 1,5-542/M8FR BK - 1406307

Schematic diagram

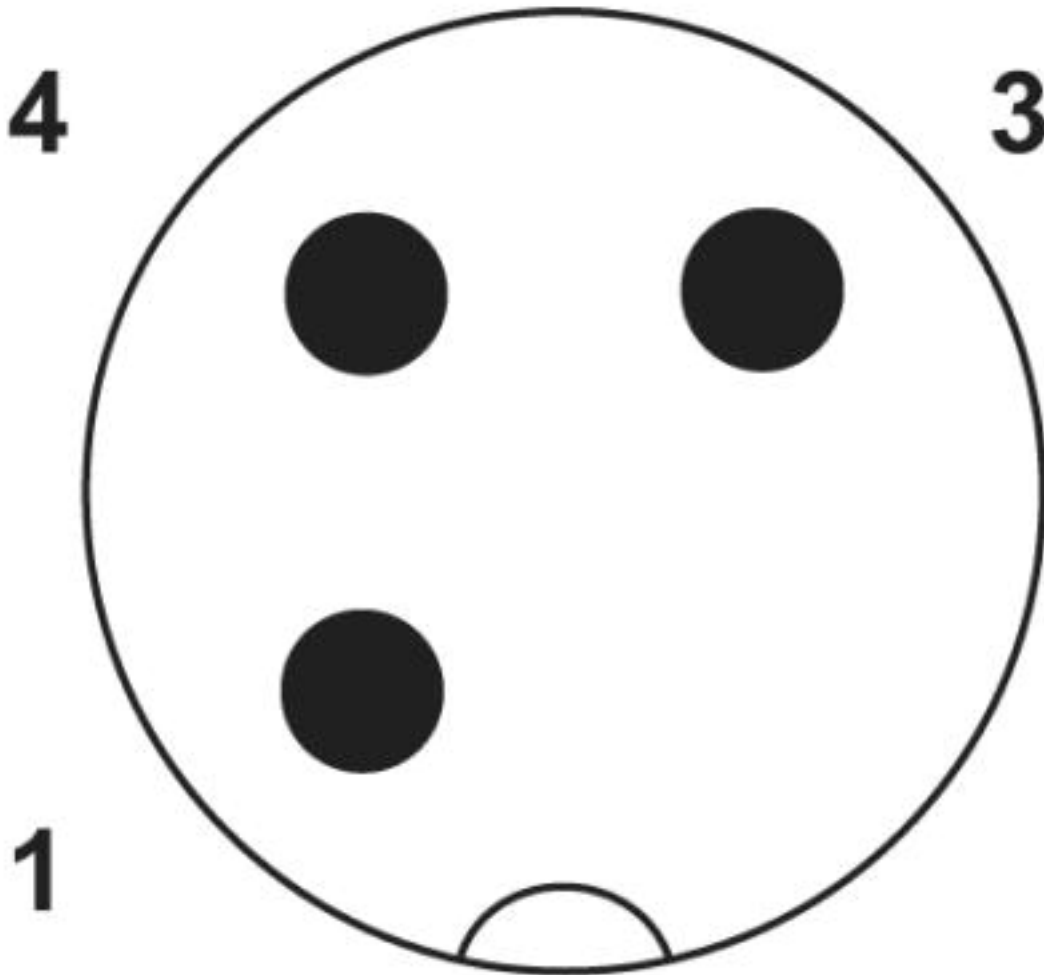

Pin assignment M12 plug, 3-pos., A-coded, view male side

Sensor/actuator cable - SAC-3P-M12MR/ 1,5-542/M8FR BK - 1406307

Schematic diagram



Pin assignment M8 socket, 3-pos., view female side

Sensor/actuator cable - SAC-3P-M12MR/ 1,5-542/M8FR BK - 1406307

Cable cross section

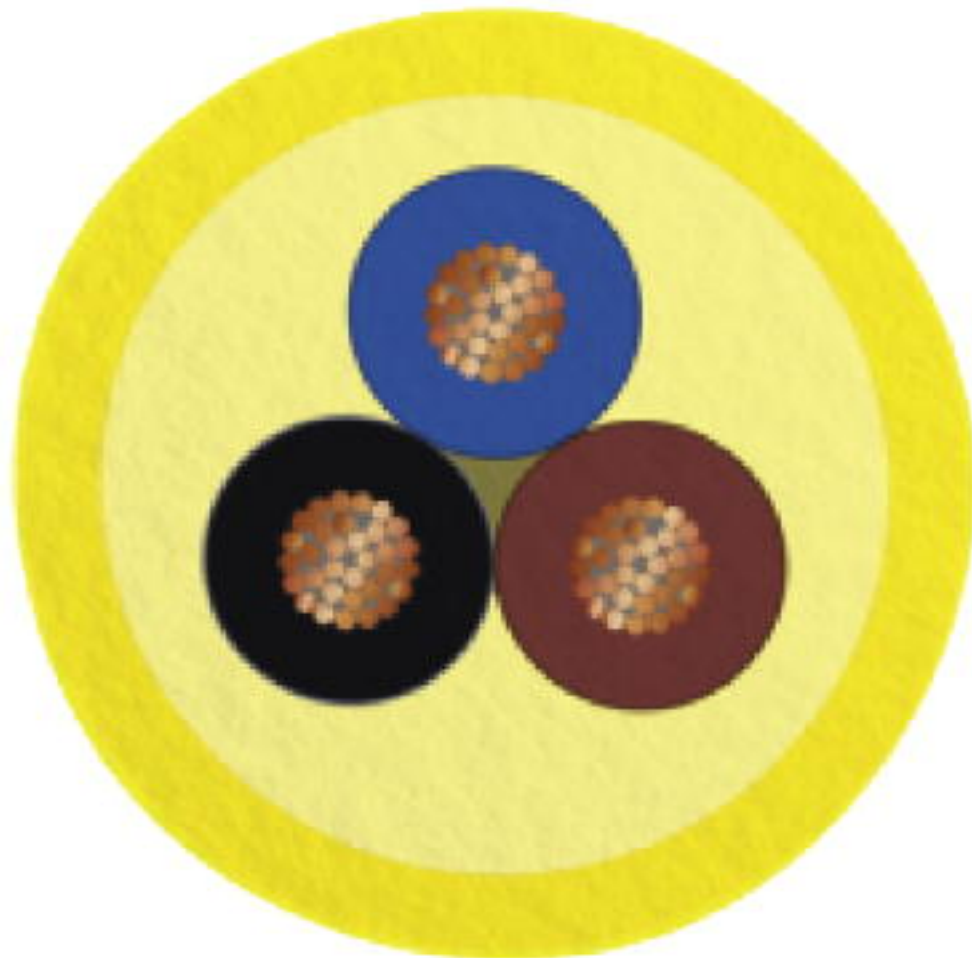

PVC yellow 105 °C [542]

Classifications

eCl@ss

| | |
|---------------|----------|
| eCl@ss 10.0.1 | 27060311 |
| eCl@ss 4.0 | 27060300 |
| eCl@ss 4.1 | 27060300 |
| eCl@ss 5.0 | 27061800 |
| eCl@ss 5.1 | 27061800 |
| eCl@ss 6.0 | 27279200 |
| eCl@ss 7.0 | 27279218 |
| eCl@ss 8.0 | 27279218 |
| eCl@ss 9.0 | 27060311 |

Sensor/actuator cable - SAC-3P-M12MR/ 1,5-542/M8FR BK - 1406307

Classifications

ETIM

| | |
|----------|----------|
| ETIM 3.0 | EC001855 |
| ETIM 4.0 | EC001855 |
| ETIM 5.0 | EC001855 |
| ETIM 6.0 | EC001855 |
| ETIM 7.0 | EC001855 |

UNSPSC

| | |
|---------------|----------|
| UNSPSC 6.01 | 31251501 |
| UNSPSC 7.0901 | 31251501 |
| UNSPSC 11 | 31251501 |
| UNSPSC 12.01 | 31251501 |
| UNSPSC 13.2 | 31251501 |
| UNSPSC 19.0 | 31251501 |
| UNSPSC 20.0 | 31251501 |
| UNSPSC 21.0 | 31251501 |

Approvals

Approvals

Approvals

UL Listed / cUL Listed / cULus Listed

Ex Approvals

Approval details

| | | | |
|--------------------|-------------------------------------------------------------------------------------|-------------------------------------------------------------------------------------------------------------------------------------------------------|---------------|
| UL Listed |  | http://database.ul.com/cgi-bin/XYV/template/LISEXT/1FRAME/index.htm | FILE E 221474 |
| Nominal voltage UN | 60 V | | |
| Nominal current IN | 4 A | | |

| | | | |
|--------------------|-------------------------------------------------------------------------------------|-------------------------------------------------------------------------------------------------------------------------------------------------------|---------------|
| cUL Listed |  | http://database.ul.com/cgi-bin/XYV/template/LISEXT/1FRAME/index.htm | FILE E 221474 |
| Nominal voltage UN | 60 V | | |
| Nominal current IN | 4 A | | |

Sensor/actuator cable - SAC-3P-M12MR/ 1,5-542/M8FR BK - 1406307

Approvals

cULus Listed



Accessories

Accessories

Plug for cable screw gland

Screw plug - PROT-M 8 MS-PA-CHAIN - 1430860

M8 sealing cap made of plastic with fixing band for sensor cables, for M8 sockets



Protective cap

Sealing cap - PROT-M12 FS-PA-CHAIN - 1430873

M12 sealing cap made of plastic with fixing band, for sensor cables, for free M12 plugs



Safety locking

Locking clip - SAC-M12-EXCLIP-M - 1558988



Locking clip for the pin side of sensor/actuator cables with M12 connector and M12 connectors for assembly, for knurl diameter: 15 mm or for Allen key with a wrench size of 14 mm, prevents the disconnection of plug-in connections without tools

Screwdriver tools

Tool - SAC BIT M8-D10 - 1208461



Nut for assembling M8 connectors with longitudinal knurl and a knurl diameter of 10 mm, for 4 mm hexagonal drive

Sensor/actuator cable - SAC-3P-M12MR/ 1,5-542/M8FR BK - 1406307

Accessories

Adapter insert - TSD-M SAC-BIT ADAPTER - 1212600



Adapter bit for TSD-M...torque tools, E6.3-1/4" drive with 4 mm hexagon to accommodate SAC bits

Tool - SAC BIT M12-D15 - 1208432



Nut for assembling sensor/actuator cables with M12 connector and M12 connectors for assembly, with a knurl diameter of 15 mm, for 4 mm hexagonal drive

Torque tool

Torque screwdriver - TSD 02 SAC - 1208487



Torque screwdriver, with preset torque of 0.2 Nm and 4 mm hexagonal drive for M8 connectors

Torque screwdriver - TSD 04 SAC - 1208429



Torque screwdriver, with preset torque of 0.4 Nm and 4 mm hexagonal drive for M12 connectors

Torque screwdriver - TSD-M 1,2NM - 1212224



Torque screw driver, accuracy as per EN ISO 6789 standard, adjustable from 0.3 - 1.2 Nm

Phoenix Contact 2020 © - all rights reserved
<http://www.phoenixcontact.com>

PHOENIX CONTACT GmbH & Co. KG
Flachsmarktstr. 8
32825 Blomberg
Germany
Tel. +49 5235 300
Fax +49 5235 3 41200
<http://www.phoenixcontact.com>