

## Sensor/actuator cable - SAC-3P- 5,0-542/ FR SH SCO BK - 1406269

Please be informed that the data shown in this PDF Document is generated from our Online Catalog. Please find the complete data in the user's documentation. Our General Terms of Use for Downloads are valid (<http://phoenixcontact.com/download>)



Sensor/actuator cable, 3-position, PVC, yellow, shielded, free cable end, on Socket angled M12 SPEEDCON, coding: A, cable length: 5 m



### Key Commercial Data

|                        |   |
|------------------------|---|
| Packing unit           | 1 pc  |
| Minimum order quantity | 50 pc   |
| GTIN                   | <br>4 046356 797832 |
| GTIN                   | 4046356797832   |

### Technical data

#### Dimensions

|                 |     |
|-----------------|-----|
| Length of cable | 5 m |
|-----------------|-----|

#### Ambient conditions

|                                 |                                  |
|---------------------------------|----------------------------------|
| Ambient temperature (operation) | -25 °C ... 90 °C (Plug / socket) |
| Degree of protection            | IP65                             |
|                                 | IP67                             |

#### General

|                              |                               |
|------------------------------|-------------------------------|
| Rated current at 40°C        | 4 A                           |
| Rated voltage                | 48 V AC                       |
|                              | 60 V DC                       |
| Number of positions          | 3                             |
| Insulation resistance        | ≥ 100 MΩ                      |
| Coding                       | A - standard                  |
| Standards/regulations        | M12 connector IEC 61076-2-101 |
| Status display               | No                            |
| Protective circuit/component | unwired                       |
| Overvoltage category         | II                            |

# Sensor/actuator cable - SAC-3P- 5,0-542/ FR SH SCO BK - 1406269

## Technical data

### General

|                             |                        |
|-----------------------------|------------------------|
| Degree of pollution         | 3                      |
| Insertion/withdrawal cycles | ≥ 100                  |
| Torque                      | 0.4 Nm (M12 connector) |

### Material

|  |   |
|--|---|
| Flammability rating according to UL 94 | HB  |
| Contact material                       | CuSn  |
| Contact surface material               | Ni/Au                                       |
| Contact carrier material               | TPU GF                                      |
| Material of grip body                  | TPU, hardly inflammable, self-extinguishing |
| Material, knurls                       | Zinc die-cast, nickel-plated                |
| Sealing material                       | NBR   |

### Standards and Regulations

|  |                               |
|--|-------------------------------|
| Standards/specifications               | M12 connector IEC 61076-2-101 |
| Flammability rating according to UL 94 | HB                            |

### Cable

|   |   |
|---|---|
| Cable type                                    | PVC yellow 105 °C                             |
| Cable type (abbreviation)                     | 542   |
| UL AWM style                                  | 2517 (105 °C / 300 V)                         |
| AWG signal line                               | 22  |
| Conductor structure signal line               | 30x 1.30 mm                                   |
| Core diameter including insulation            | 1.27 mm ±0.03 mm                              |
| Wire colors                                   | brown, blue, black                            |
| Overall twist                                 | 3 wires, twisted                              |
| Shielding                                     | Tinned copper braided shield                  |
| Optical shield covering                       | 85 %  |
| External sheath, color                        | yellow  |
| External cable diameter D                     | 5.2 mm ±0.2 mm                                |
| Minimum bending radius, flexible installation | 12 x D  |
| Cable weight                                  | 40 kg/km                                      |
| Outer sheath, material                        | PVC   |
| Material conductor insulation                 | PVC   |
| Conductor material                            | Tin-plated Cu litz wires                      |
| Insulation resistance                         | ≥ (550 M Ohms/m @ 500V)                       |
| Conductor resistance                          | max. 50.5 Ω/km (20 °C)                        |
| Nominal voltage, cable                        | 300 V   |
| Special properties                            | UL standards PLTC and ITC                     |
| Flame resistance                              | FT4   |
| Other resistance                              | UV resistant                                  |
| Ambient temperature (operation)               | -30 °C ... 105 °C (cable, fixed installation) |

# Sensor/actuator cable - SAC-3P- 5,0-542/ FR SH SCO BK - 1406269

## Technical data

### Cable

|  |   |
|--|---|
|  | -5 °C ... 105 °C (cable, flexible installation) |
|--|---|

### Environmental Product Compliance

|            |   |
|------------|---|
| China RoHS | Environmentally friendly use period: unlimited = EFUP-e |
|            | No hazardous substances above threshold values          |

## Drawings

Dimensional drawing

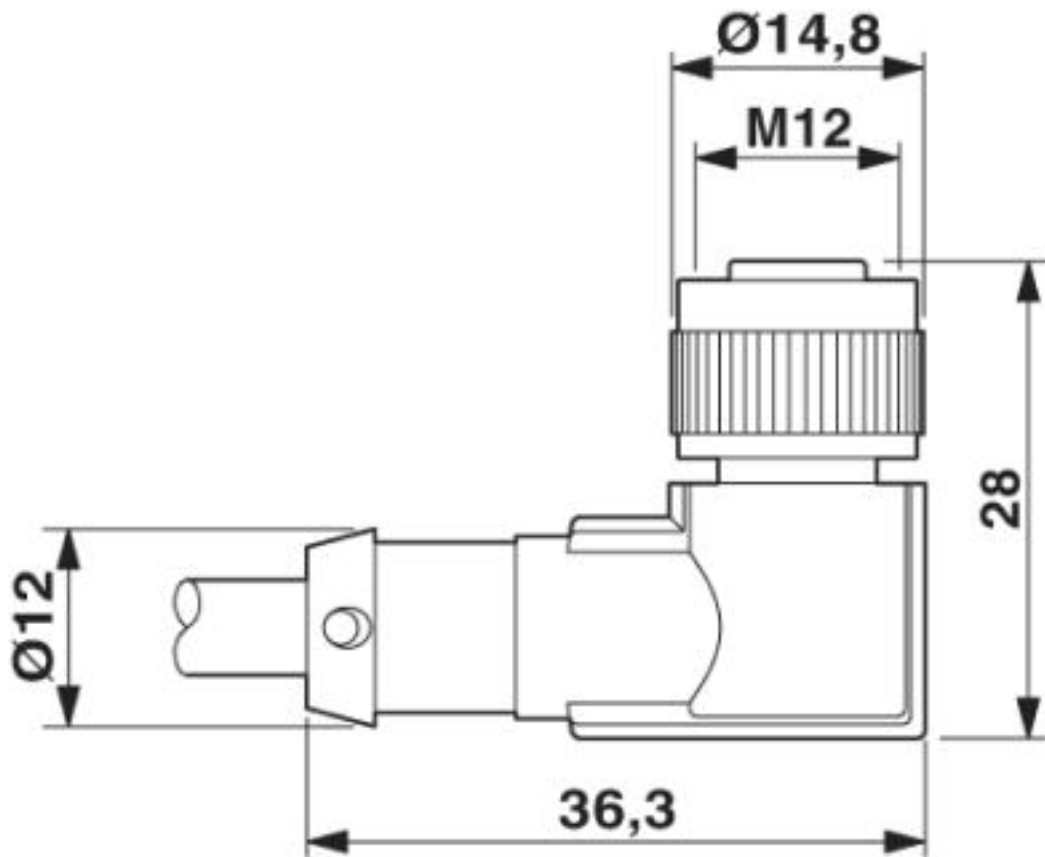

M12 x 1 socket, angled, shielded

## Sensor/actuator cable - SAC-3P- 5,0-542/ FR SH SCO BK - 1406269

Circuit diagram

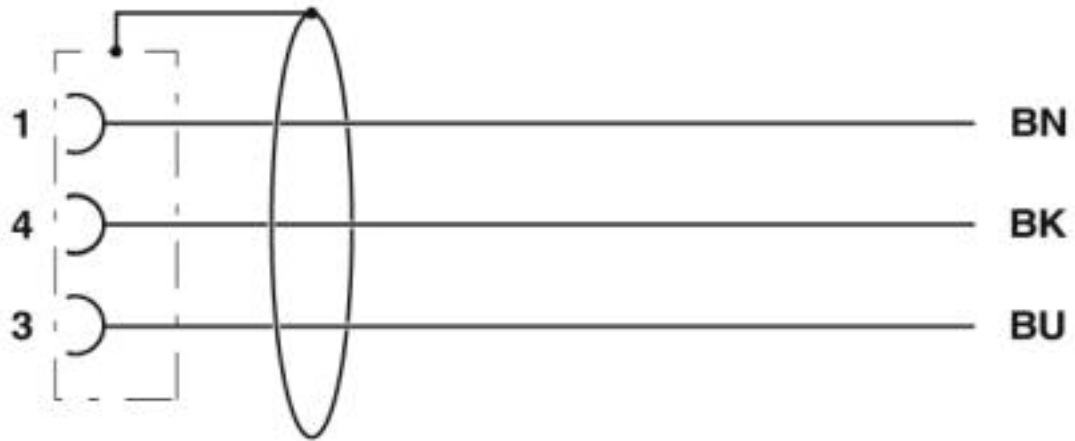

Contact assignment of the M12 socket

# Sensor/actuator cable - SAC-3P- 5,0-542/ FR SH SCO BK - 1406269

Schematic diagram

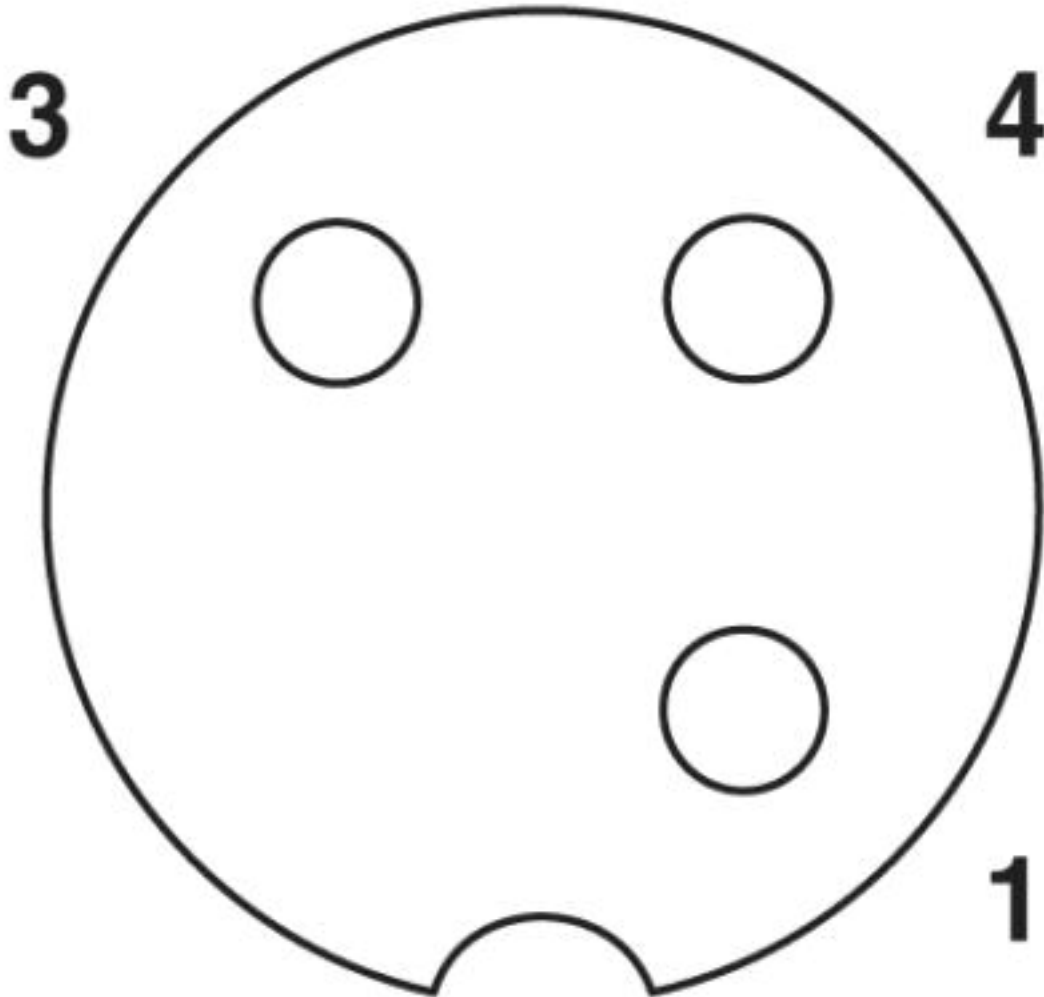

Pin assignment M12 socket, 3-pos., A-coded, view female side

# Sensor/actuator cable - SAC-3P- 5,0-542/ FR SH SCO BK - 1406269

Cable cross section

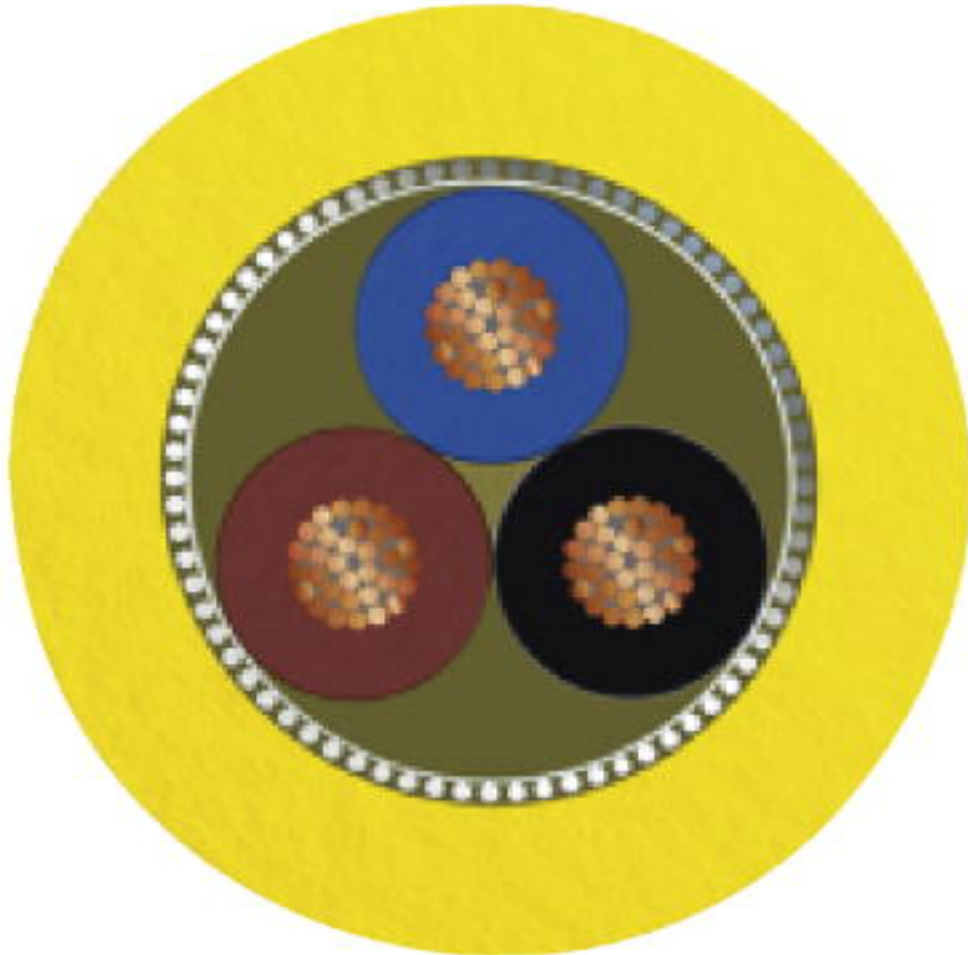

PVC yellow 105 °C [542]

## Classifications

eCl@ss

|               |          |
|---------------|----------|
| eCl@ss 10.0.1 | 27060311 |
| eCl@ss 4.0    | 27060300 |
| eCl@ss 4.1    | 27060300 |
| eCl@ss 5.0    | 27061800 |
| eCl@ss 5.1    | 27061800 |
| eCl@ss 6.0    | 27279200 |
| eCl@ss 7.0    | 27279218 |
| eCl@ss 8.0    | 27279218 |
| eCl@ss 9.0    | 27060311 |

# Sensor/actuator cable - SAC-3P- 5,0-542/ FR SH SCO BK - 1406269

## Classifications

### ETIM

|          |          |
|----------|----------|
| ETIM 3.0 | EC001855 |
| ETIM 4.0 | EC001855 |
| ETIM 5.0 | EC001855 |
| ETIM 6.0 | EC001855 |
| ETIM 7.0 | EC001855 |

### UNSPSC

|               |          |
|---------------|----------|
| UNSPSC 6.01   | 31251501 |
| UNSPSC 7.0901 | 31251501 |
| UNSPSC 11     | 31251501 |
| UNSPSC 12.01  | 31251501 |
| UNSPSC 13.2   | 31251501 |
| UNSPSC 19.0   | 31251501 |
| UNSPSC 20.0   | 31251501 |
| UNSPSC 21.0   | 31251501 |

## Approvals

### Approvals

#### Approvals

UL Listed / cUL Listed / cULus Listed

#### Ex Approvals

### Approval details

|                    |   |   |               |
|--------------------|---|---|---------------|
| UL Listed          |  | <a href="http://database.ul.com/cgi-bin/XYV/template/LISEXT/1FRAME/index.htm">http://database.ul.com/cgi-bin/XYV/template/LISEXT/1FRAME/index.htm</a> | FILE E 221474 |
| Nominal voltage UN | 300 V   |   |               |
| Nominal current IN | 4 A   |   |               |

|                    |   |   |               |
|--------------------|---|---|---------------|
| cUL Listed         |  | <a href="http://database.ul.com/cgi-bin/XYV/template/LISEXT/1FRAME/index.htm">http://database.ul.com/cgi-bin/XYV/template/LISEXT/1FRAME/index.htm</a> | FILE E 221474 |
| Nominal voltage UN | 300 V   |   |               |
| Nominal current IN | 4 A   |   |               |

# Sensor/actuator cable - SAC-3P- 5,0-542/ FR SH SCO BK - 1406269

## Approvals

cULus Listed



## Accessories

### Accessories

#### Plug for cable screw gland

Screw plug - PROT-M12 MS-PA-CHAIN - 1430899

M12 sealing cap with fixing band, for sensor cables, for free M12 sockets



## Safety locking

Locking clip - SAC-M12-EXCLIP-F - 1558991



Locking clip for the socket side of sensor/actuator cables with M12 connector and M12 connectors for assembly, for knurl diameter: 15 mm or for Allen key with a wrench size of 14 mm, prevents the disconnection of plug-in connections without tools

## Screwdriver tools

Adapter insert - TSD-M SAC-BIT ADAPTER - 1212600



Adapter bit for TSD-M...torque tools, E6.3-1/4" drive with 4 mm hexagon to accommodate SAC bits

Tool - SAC BIT M12-D15 - 1208432



Nut for assembling sensor/actuator cables with M12 connector and M12 connectors for assembly, with a knurl diameter of 15 mm, for 4 mm hexagonal drive

## Torque tool



## Sensor/actuator cable - SAC-3P- 5,0-542/ FR SH SCO BK - 1406269

### Accessories

Torque screwdriver - TSD 04 SAC - 1208429



Torque screwdriver, with preset torque of 0.4 Nm and 4 mm hexagonal drive for M12 connectors

---

Torque screwdriver - TSD-M 1,2NM - 1212224



Torque screw driver, accuracy as per EN ISO 6789 standard, adjustable from 0.3 - 1.2 Nm

---

---

Phoenix Contact 2020 © - all rights reserved  
<http://www.phoenixcontact.com>

PHOENIX CONTACT GmbH & Co. KG  
Flachsmarktstr. 8  
32825 Blomberg  
Germany  
Tel. +49 5235 300  
Fax +49 5235 3 41200  
<http://www.phoenixcontact.com>