

Sensor/actuator cable - SAC-8P-MS/ 5,0-542 SH SCO BK - 1406072

Please be informed that the data shown in this PDF Document is generated from our Online Catalog. Please find the complete data in the user's documentation. Our General Terms of Use for Downloads are valid (<http://phoenixcontact.com/download>)



Sensor/actuator cable, 8-position, PVC, yellow, shielded, Plug straight M12 SPEEDCON, coding: A, on free cable end, cable length: 5 m



Key Commercial Data

Packing unit	1 pc
Minimum order quantity	50 pc
GTIN	 4 046356 799751
GTIN	4046356799751

Technical data

Dimensions

Length of cable	5 m
-----------------	-----

Ambient conditions

Ambient temperature (operation)	-25 °C ... 90 °C (Plug / socket)
Degree of protection	IP65
	IP67

General

Rated current at 40°C	2 A
Rated voltage	30 V AC
	30 V DC
Number of positions	8
Color handle area	black
Insulation resistance	≥ 100 MΩ
Coding	A - standard
Standards/regulations	M12 connector IEC 61076-2-101
Status display	No
Protective circuit/component	unwired

Sensor/actuator cable - SAC-8P-MS/ 5,0-542 SH SCO BK - 1406072

Technical data

General

Overvoltage category	II
Degree of pollution	3
Insertion/withdrawal cycles	≥ 100
Torque	0.4 Nm (M12 connector)

Material

Flammability rating according to UL 94	HB
Contact material	CuZn
Contact surface material	Ni/Au
Contact carrier material	TPU GF
Material of grip body	TPU, hardly inflammable, self-extinguishing
Material, knurls	Zinc die-cast, nickel-plated

Standards and Regulations

Standards/specifications	M12 connector IEC 61076-2-101
Flammability rating according to UL 94	HB

Cable

Cable type	PVC yellow 105 °C
Cable type (abbreviation)	542
UL AWM style	2517 (105 °C / 300 V)
AWG signal line	24
Conductor structure signal line	32x 1.10 mm
Core diameter including insulation	1.12 mm ±0.03 mm
Wire colors	white, brown, green, yellow, gray, pink, blue, red
Overall twist	8 wires around filler to the core
Shielding	Tinned copper braided shield
Optical shield covering	85 %
External sheath, color	yellow
External cable diameter D	6.3 mm ±0.2 mm
Minimum bending radius, flexible installation	12 x D
Cable weight	58 kg/km
Outer sheath, material	PVC
Material, filler	PP
Material conductor insulation	PVC
Conductor material	Tin-plated Cu litz wires
Insulation resistance	≥ (550 M Ohms/m @ 500V)
Conductor resistance	max. 79.7 Ω/km (20 °C)
Nominal voltage, cable	300 V
Flame resistance	FT1, VW-1
Other resistance	UV resistant
Ambient temperature (operation)	-30 °C ... 105 °C (cable, fixed installation)

Sensor/actuator cable - SAC-8P-MS/ 5,0-542 SH SCO BK - 1406072

Technical data

Cable

	-5 °C ... 105 °C (cable, flexible installation)
--	---

Environmental Product Compliance

REACH SVHC	Lead 7439-92-1
China RoHS	Environmentally Friendly Use Period = 50 years
	For details about hazardous substances go to tab "Downloads", Category "Manufacturer's declaration"

Drawings

Schematic diagram

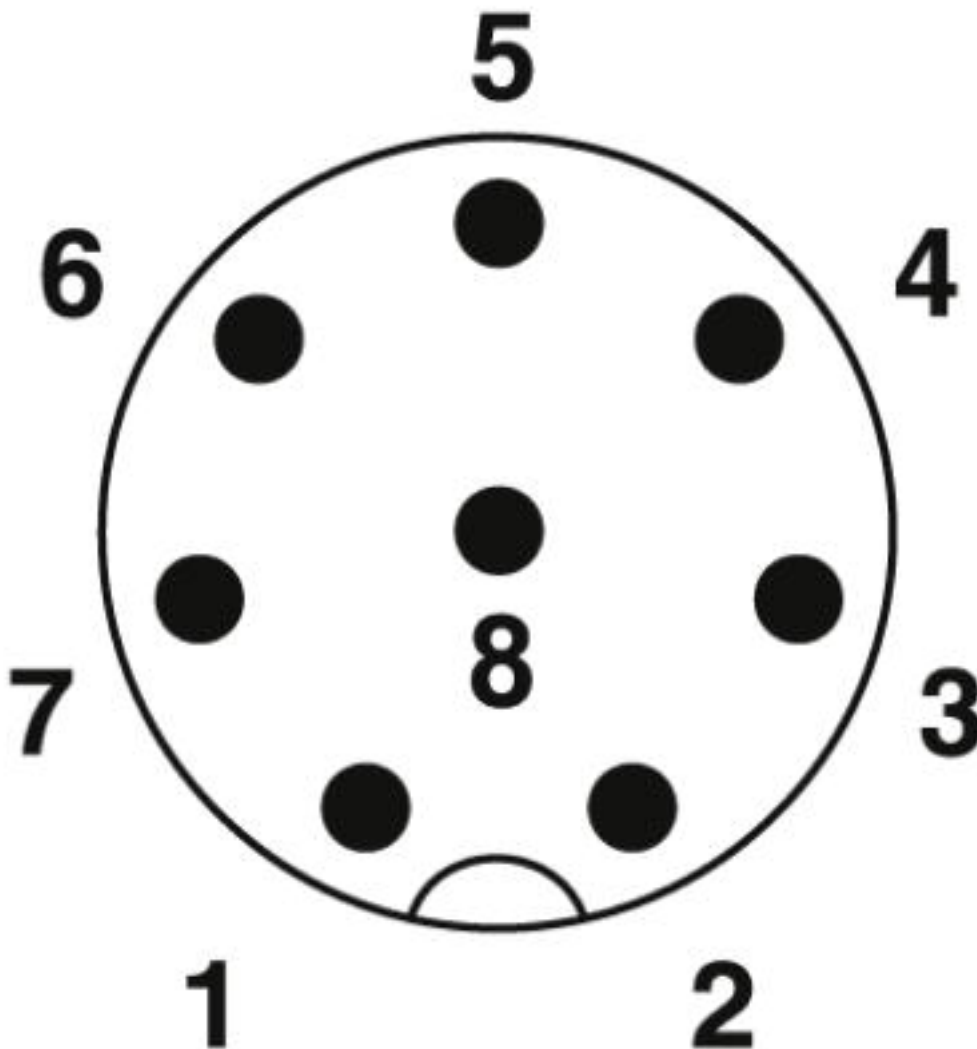

Pin assignment M12 plug, 8-pos., view plug side

Sensor/actuator cable - SAC-8P-MS/ 5,0-542 SH SCO BK - 1406072

Dimensional drawing

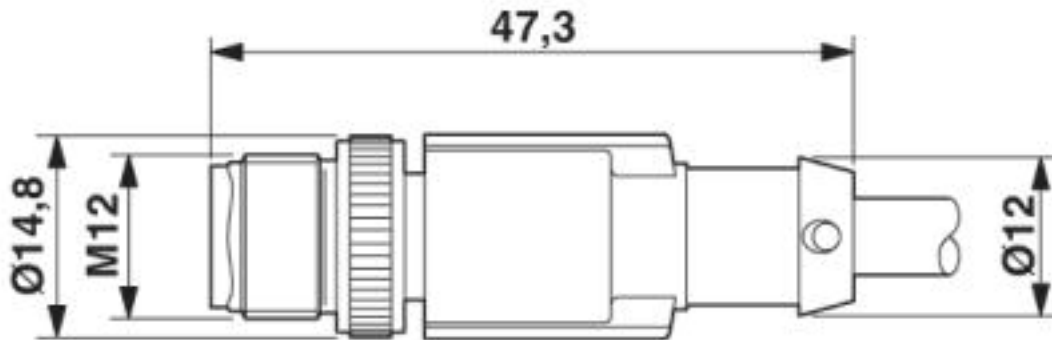

Plug, M12 x 1, straight, shielded

Circuit diagram

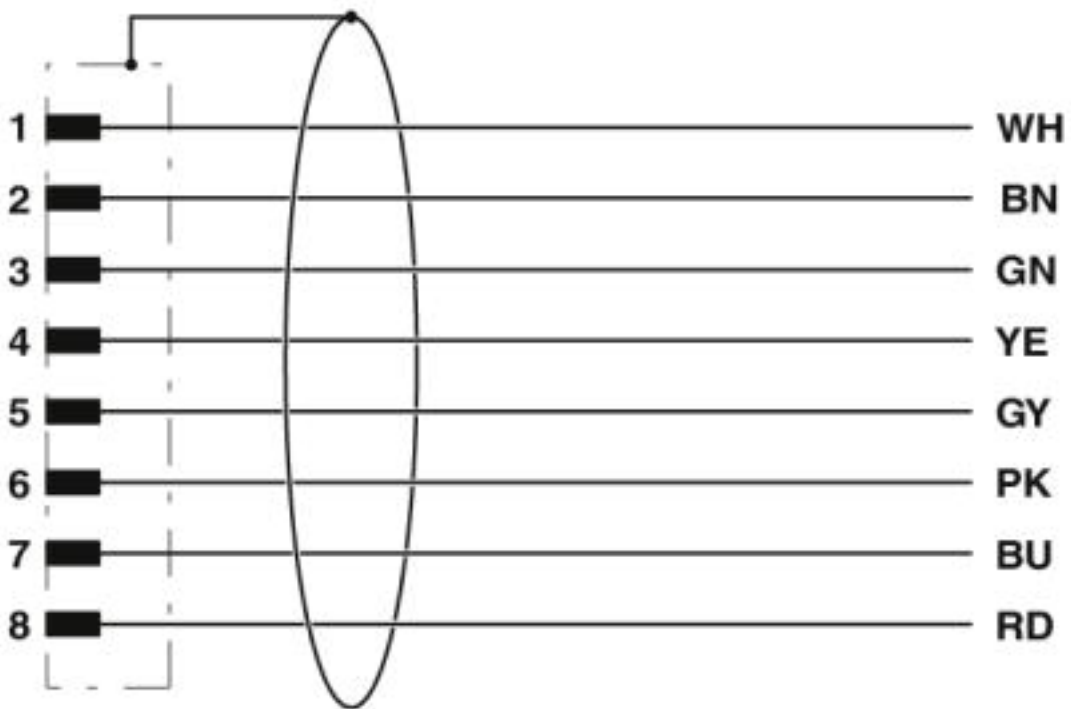

Contact assignment of the M12 plug

Sensor/actuator cable - SAC-8P-MS/ 5,0-542 SH SCO BK - 1406072

Cable cross section



PVC yellow 105 °C [542]

Classifications

eCl@ss

eCl@ss 10.0.1	27060311
eCl@ss 4.0	27060300
eCl@ss 4.1	27060300
eCl@ss 5.0	27061800
eCl@ss 5.1	27061800
eCl@ss 6.0	27279200
eCl@ss 7.0	27279218
eCl@ss 8.0	27279218
eCl@ss 9.0	27060311

Sensor/actuator cable - SAC-8P-MS/ 5,0-542 SH SCO BK - 1406072

Classifications

ETIM

ETIM 3.0	EC001855
ETIM 4.0	EC001855
ETIM 5.0	EC001855
ETIM 6.0	EC001855
ETIM 7.0	EC001855

UNSPSC

UNSPSC 6.01	31251501
UNSPSC 7.0901	31251501
UNSPSC 11	31251501
UNSPSC 12.01	31251501
UNSPSC 13.2	31251501
UNSPSC 19.0	31251501
UNSPSC 20.0	31251501
UNSPSC 21.0	31251501

Approvals

Approvals

Approvals

UL Listed / cUL Listed / cULus Listed

Ex Approvals

Approval details

UL Listed		http://database.ul.com/cgi-bin/XYV/template/LISEXT/1FRAME/index.htm	FILE E 221474
Nominal voltage UN	30 V		
Nominal current IN	2 A		

cUL Listed		http://database.ul.com/cgi-bin/XYV/template/LISEXT/1FRAME/index.htm	FILE E 221474
Nominal voltage UN	30 V		
Nominal current IN	2 A		

Sensor/actuator cable - SAC-8P-MS/ 5,0-542 SH SCO BK - 1406072

Approvals

cULus Listed



Phoenix Contact 2020 © - all rights reserved
<http://www.phoenixcontact.com>

PHOENIX CONTACT GmbH & Co. KG
Flachsmarktstr. 8
32825 Blomberg
Germany
Tel. +49 5235 300
Fax +49 5235 3 41200
<http://www.phoenixcontact.com>