

Sensor/actuator cable - SAC-4P-M8MS/0,5-542/M8FR SH BK - 1406004

Please be informed that the data shown in this PDF Document is generated from our Online Catalog. Please find the complete data in the user's documentation. Our General Terms of Use for Downloads are valid (<http://phoenixcontact.com/download>)



Sensor/actuator cable, 4-position, PVC, yellow, shielded, Plug straight M8, on Socket angled M8, cable length: 0.5 m



Key Commercial Data

Packing unit	1 pc
Minimum order quantity	50 pc
GTIN	 4 046356 800259
GTIN	4046356800259

Technical data

Dimensions

Length of cable	0.5 m
-----------------	-------

Ambient conditions

Ambient temperature (operation)	-25 °C ... 90 °C (Plug / socket)
Degree of protection	IP65
	IP67

General

Rated current at 40°C	4 A
Rated voltage	48 V AC
	60 V DC
Number of positions	4
Insulation resistance	≥ 100 MΩ
Coding	A - standard
Standards/regulations	M8 connector IEC 61076-2-104
Status display	No
Protective circuit/component	unwired
Overvoltage category	II

Sensor/actuator cable - SAC-4P-M8MS/0,5-542/M8FR SH BK - 1406004

Technical data

General

Degree of pollution	3
Insertion/withdrawal cycles	≥ 100
Torque	0.2 Nm (M8 connectors)

Material

Flammability rating according to UL 94	HB
Contact material	CuSn
Contact surface material	Ni/Au
Contact carrier material	TPU GF
Material of grip body	TPU, hardly inflammable, self-extinguishing
Material, knurls	Zinc die-cast, nickel-plated
Sealing material	NBR

Standards and Regulations

Standards/specifications	M8 connector IEC 61076-2-104
Flammability rating according to UL 94	HB

Cable

Cable type	PVC yellow 105 °C
Cable type (abbreviation)	542
UL AWM style	2517 (105 °C / 300 V)
AWG signal line	24
Core diameter including insulation	1.12 mm ±0.03 mm
Wire colors	brown, blue, black, white
Overall twist	4 wires, twisted
Shielding	Tinned copper braided shield
Optical shield covering	85 %
External sheath, color	yellow
External cable diameter D	4.9 mm ±0.2 mm
Minimum bending radius, flexible installation	12 x D
Cable weight	37 kg/km
Outer sheath, material	PVC
Material conductor insulation	PVC
Conductor material	Tin-plated Cu litz wires
Insulation resistance	≥ (550 M Ohms/m @ 500V)
Conductor resistance	max. 79.7 Ω/km (20 °C)
Nominal voltage, cable	300 V
Flame resistance	FT4
Other resistance	UV resistant
Ambient temperature (operation)	-30 °C ... 105 °C (cable, fixed installation)

Environmental Product Compliance

REACH SVHC	Lead 7439-92-1
------------	----------------

Sensor/actuator cable - SAC-4P-M8MS/0,5-542/M8FR SH BK - 1406004

Technical data

Environmental Product Compliance

China RoHS	Environmentally Friendly Use Period = 50 years
	For details about hazardous substances go to tab "Downloads", Category "Manufacturer's declaration"

Drawings

Dimensional drawing

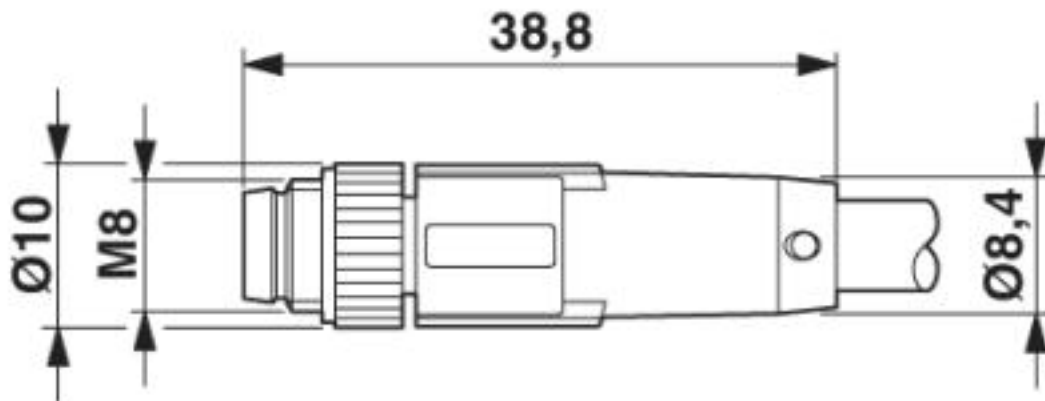

Plug M8 x 1, straight, shielded

Sensor/actuator cable - SAC-4P-M8MS/0,5-542/M8FR SH BK - 1406004

Dimensional drawing

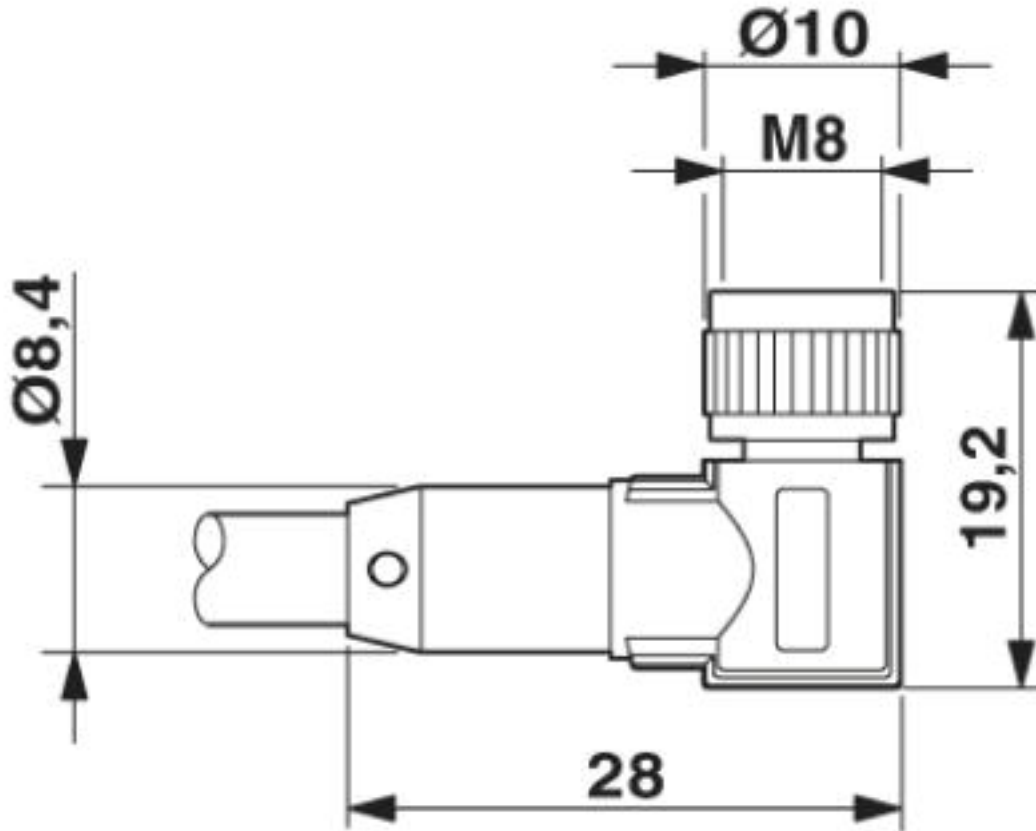

Socket M8 x 1, angled, shielded

Sensor/actuator cable - SAC-4P-M8MS/0,5-542/M8FR SH BK - 1406004

Circuit diagram

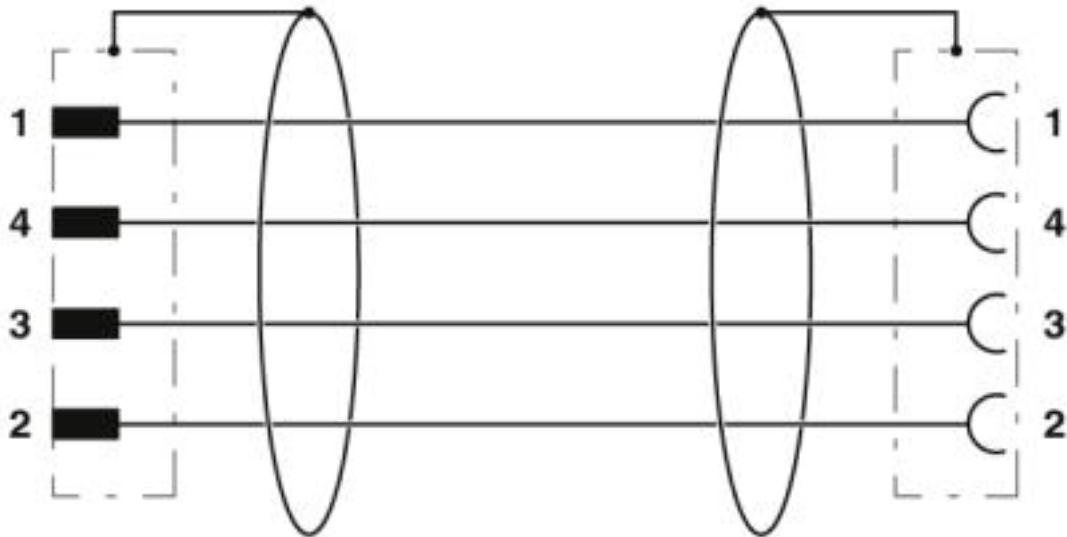

Contact assignment of M8 plugs/sockets

Sensor/actuator cable - SAC-4P-M8MS/0,5-542/M8FR SH BK - 1406004

Schematic diagram

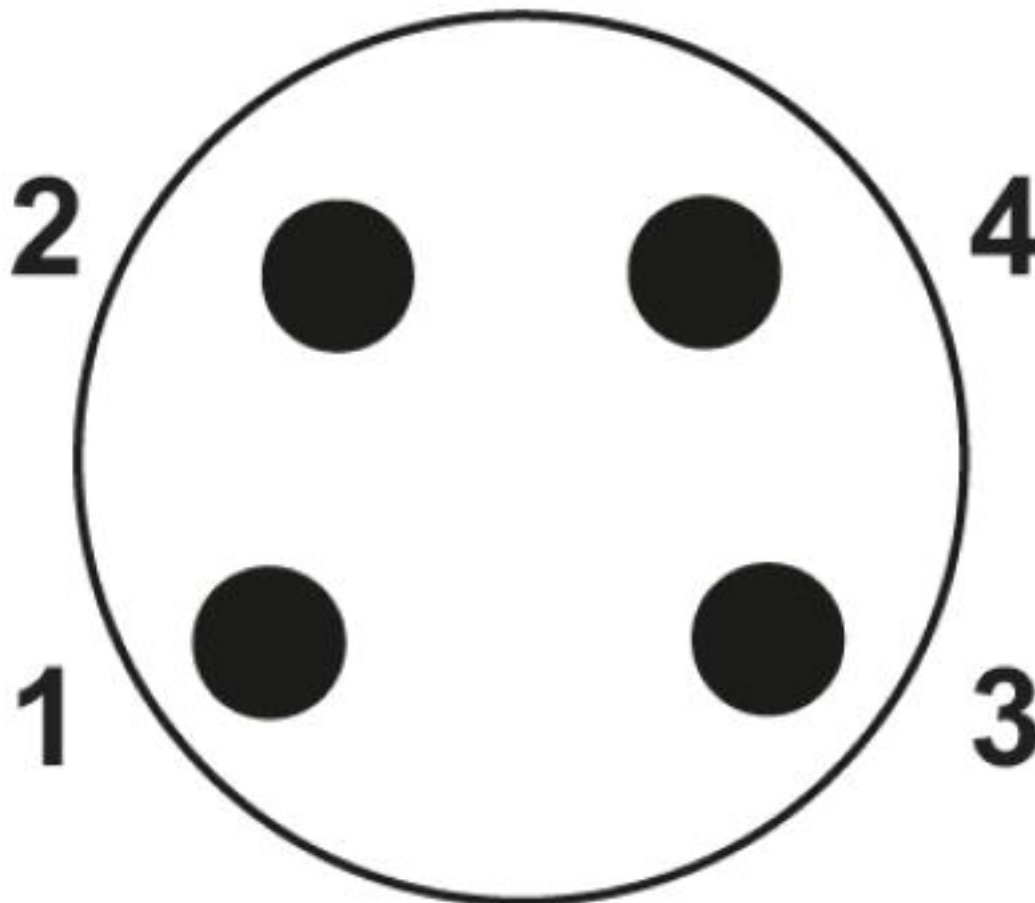

Pin assignment M8 plug, 4-pos., view male side

Sensor/actuator cable - SAC-4P-M8MS/0,5-542/M8FR SH BK - 1406004

Schematic diagram

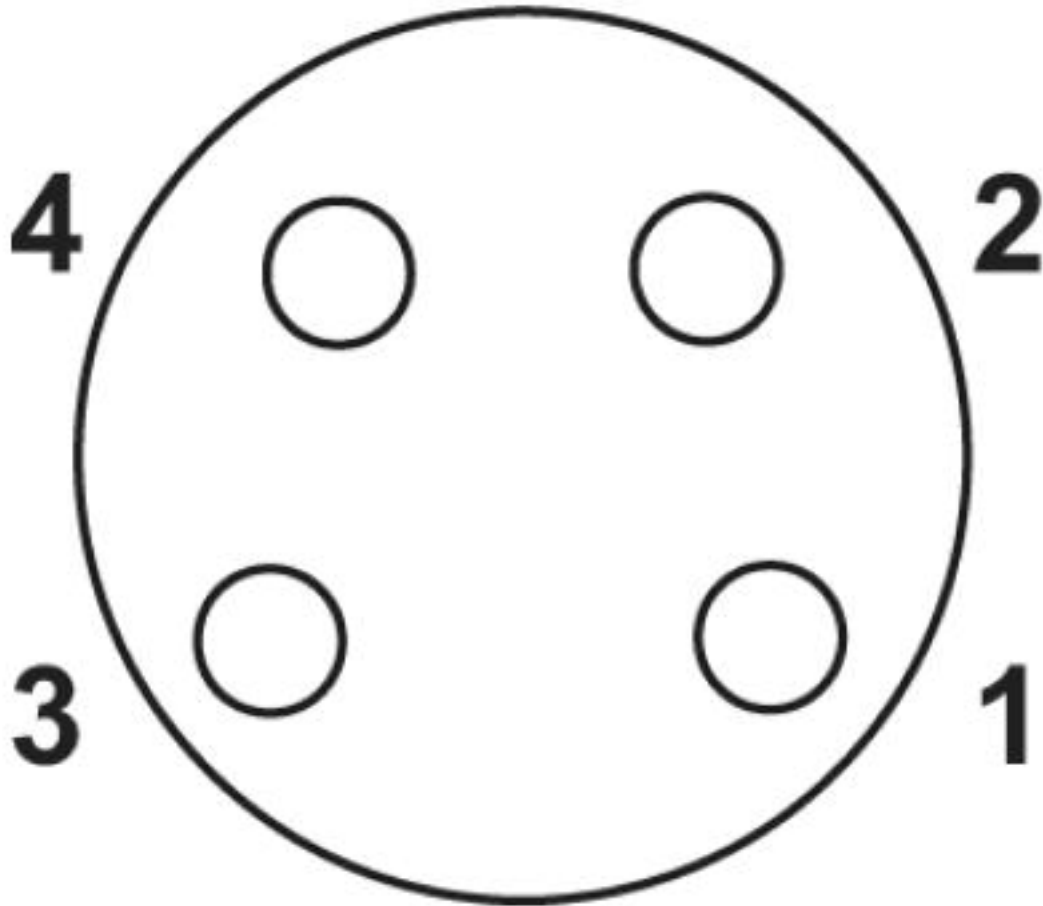

Pin assignment M8 socket, 4-pos., view female side

Sensor/actuator cable - SAC-4P-M8MS/0,5-542/M8FR SH BK - 1406004

Cable cross section

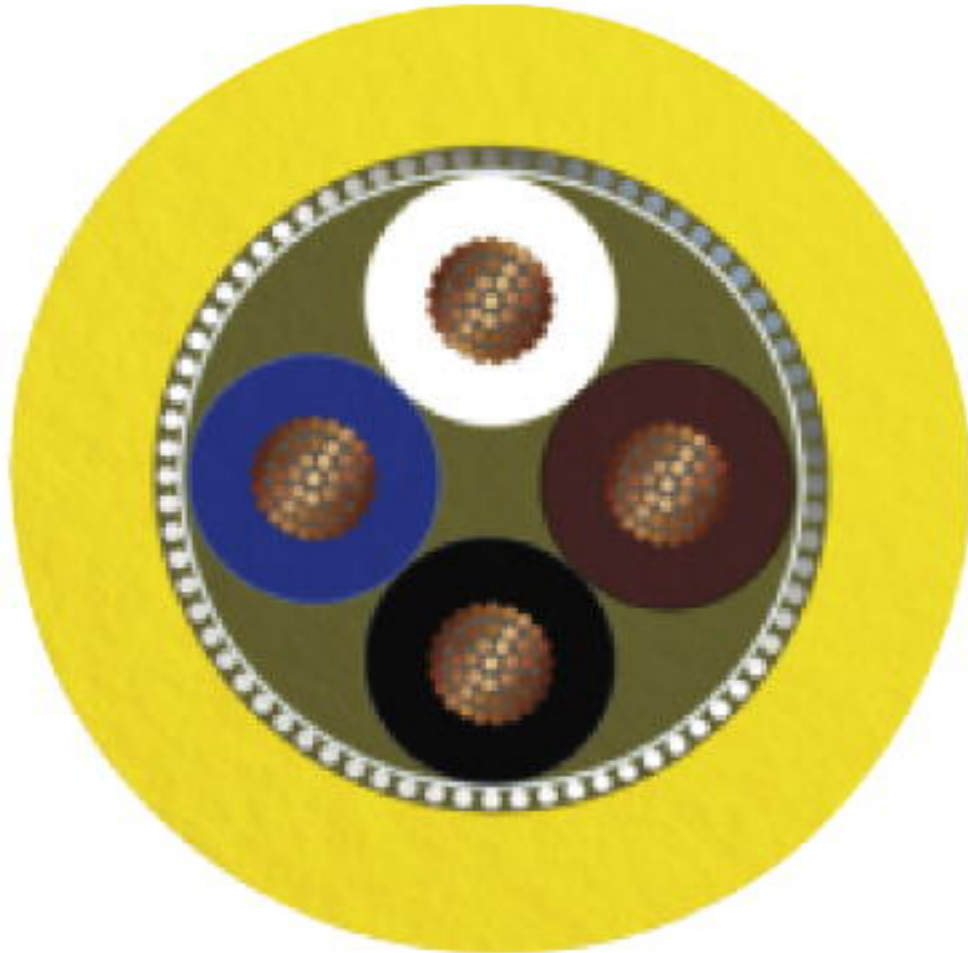

PVC yellow 105 °C [542]

Classifications

eCl@ss

eCl@ss 10.0.1	27060311
eCl@ss 4.0	27060300
eCl@ss 4.1	27060300
eCl@ss 5.0	27061800
eCl@ss 5.1	27061800
eCl@ss 6.0	27279200
eCl@ss 7.0	27279218
eCl@ss 8.0	27279218
eCl@ss 9.0	27060311

Sensor/actuator cable - SAC-4P-M8MS/0,5-542/M8FR SH BK - 1406004

Classifications

ETIM

ETIM 3.0	EC001855
ETIM 4.0	EC001855
ETIM 5.0	EC001855
ETIM 6.0	EC001855
ETIM 7.0	EC001855

UNSPSC

UNSPSC 6.01	31251501
UNSPSC 7.0901	31251501
UNSPSC 11	31251501
UNSPSC 12.01	31251501
UNSPSC 13.2	31251501
UNSPSC 19.0	31251501
UNSPSC 20.0	31251501
UNSPSC 21.0	31251501

Approvals

Approvals

Approvals

UL Listed / cUL Listed / cULus Listed

Ex Approvals

Approval details

UL Listed		http://database.ul.com/cgi-bin/XYV/template/LISEXT/1FRAME/index.htm	FILE E 221474
Nominal voltage UN	30 V		
Nominal current IN	4 A		

cUL Listed		http://database.ul.com/cgi-bin/XYV/template/LISEXT/1FRAME/index.htm	FILE E 221474
Nominal voltage UN	30 V		
Nominal current IN	4 A		

Sensor/actuator cable - SAC-4P-M8MS/0,5-542/M8FR SH BK - 1406004

Approvals

cULus Listed



Accessories

Accessories

Conductor marking

Insert label - PABA WH/23 - 1013779



Insert label, Strip, white, unlabeled, can be labeled with: CMS-P1-PLOTTER, mounting type: thread on, cable diameter range: 1.5 ... 35 mm, lettering field size: 23 x 4 mm, Number of individual labels: 20

Insert label - PABA YE/23 - 1013782



Insert label, Strip, yellow, unlabeled, can be labeled with: CMS-P1-PLOTTER, mounting type: thread on, cable diameter range: 1.5 ... 35 mm, lettering field size: 23 x 4 mm, Number of individual labels: 20

Marker pen

Marker pen - B-STIFT - 1051993



Marker pen, for manual labeling of unprinted Zack strips, smear-proof and waterproof, line thickness 0.5 mm

Plug for cable screw gland

Screw plug - PROT-M 8 MS-PA-CHAIN - 1430860

M8 sealing cap made of plastic with fixing band for sensor cables, for M8 sockets



Protective cap

Sensor/actuator cable - SAC-4P-M8MS/0,5-542/M8FR SH BK - 1406004

Accessories

Sealing cap - PROT-M 8 FS-PA-CHAIN - 1430857

M8 sealing cap made of plastic with fixing band for sensor cables, for M8 plugs



Screwdriver tools

Tool - SAC BIT M8-D10 - 1208461



Nut for assembling M8 connectors with longitudinal knurl and a knurl diameter of 10 mm, for 4 mm hexagonal drive

Torque tool

Torque screwdriver - TSD 02 SAC - 1208487



Torque screwdriver, with preset torque of 0.2 Nm and 4 mm hexagonal drive for M8 connectors

Phoenix Contact 2020 © - all rights reserved
<http://www.phoenixcontact.com>

PHOENIX CONTACT GmbH & Co. KG
Flachsmarktstr. 8
32825 Blomberg
Germany
Tel. +49 5235 300
Fax +49 5235 3 41200
<http://www.phoenixcontact.com>