

Model No.: PMT-40N25AL02-04
 Product Line: Tymphany

Rev: 2
 Last Update: 2019-11-21 00:50:52

Product Description

This 40 mm 4 ohm compact premium micro transducer is designed for computer, television array, and similar applications. It features a neodymium magnet, a light aluminium cone, and a high-temperature polycarbonate frame. The PMT family's transducers feature low resonant frequencies, low THD and a full range bandwidth.



Mechanical Drawing

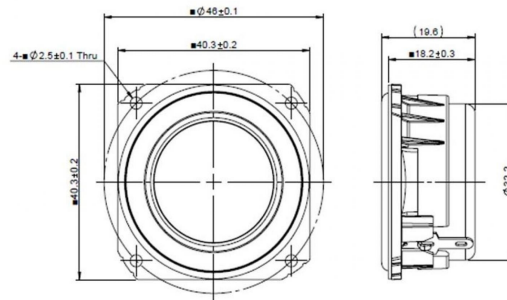

Specifications

DC Resistance	Revc	Ohms	3.52	5.0%	Energy Bandwidth Product	EBP	(1/Qes)*fs
Minimum Impedance	Zmin	Ohms	3.74	7.5%	Moving Mass	Mms	g
Voice Coil Inductance	Le	mH	0.07		Suspension Compliance	Cms	um/N
Resonant Frequency	Fs	Hz	240.77	15%	Effective Cone diameter	D	cm
Mechanical Q Factor	Qms		2.39		Effective Piston Area	Sd	cm^2
Electrical Q Factor	Qes	0.58			Effective Volume	Vas	L
Total Q Factor	Qts	0.47			Motor Force Factor	BL	Tm
Ratio Fs/Qts	F	Fs/Qts	516.68		Motor Efficiency Factor	β	(T*M^2)/Ohms
Half Space Sensitivity @2.83V	db@2.83V/1M	dB	85.97	+/- 1.0db	Voice coil former Material	VCfm	KSV
Half Space Sensitivity @1W/1M	db@1W/1M	dB	82.7	+/- 1.0db	Voice coil inner diameter	VCd	mm
Gap Height	Gh	mm	2		Rated Noise Power	P	W
Maximum Linear Excursion	Xmax	mm	1.9		Test Spectrum Bandwidth		100Hz-20KHz
Ferrofluid Type	FF		APG834		Driver Size	Inch	40 mm
Driver Mass	Kg	0.06					

Frequency and Impedance Response

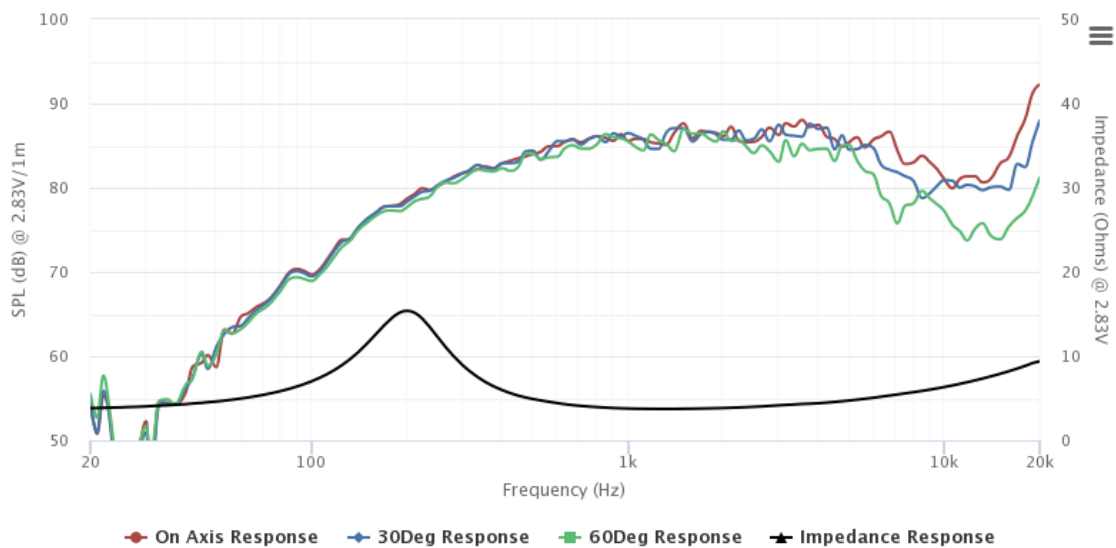

Highcharts.com