

GP-A SERIES

Related Information

- General terms and conditions..... F-3
- Selection guide P.1021~
- Glossary of terms..... P.1587
- General precautions P.1595



Resolution 0.04 % F.S., Linearity ± 0.5 % F.S., IP67G environment resistance

Accurate measurement of minute displacements

Minute displacement of metallic objects can be accurately measured with a resolution of 0.04 % F.S.

[**GP-A5S** (For 1 mm 0.039 in sensing type)]
 [Resolution: 0.4 μm 0.016 mil]

Linearity ± 0.5 % F.S.

Displacement is accurately output since it incorporates a high accuracy linearity correction circuit.

ENVIRONMENTAL RESISTANCE

The sensor head protected as per IP67G

With IP67G environment resistance, various measurements are possible under many different conditions.

FUNCTIONS

Equipped with a zero-adjustment function

By pressing the zero-adjustment button, you can reset the output voltage to 0 V with one touch. (Resets the current output to 4 mA)

This function comes in handy when performing tolerance diagnosis of a masterwork to be used as the standard. Easy adjustment for product changes.
 (Remote operation is also possible) (by way of an external input.)



MOUNTING

Sensor heads can be mounted in narrow spaces

If mounting standard types and different frequency types parallel to each other, they use up one-third the space needed for mounting compared to the same models. In addition, the **GP-A14F** type can be mounted close together and the sensor heads can be set in a narrow range for distortion and other difficult measurements.

BASIC PERFORMANCE

Stable temperature characteristics

These sensor heads boast a 2 mm 0.079 in or more sensing range enabling 0.03 % F.S./ $^{\circ}\text{C}$. (Excluding the different frequency type).

[**GP-A8S** (For 2 mm 0.079 in sensing type)]
 [Temperature characteristics: 0.6 $\mu\text{m}/^{\circ}\text{C}$ 0.024 mil/ $^{\circ}\text{C}$]

OPERABILITY

Fine adjustment of output

Fine adjustment according to the sensing conditions is possible with shift and span functions.

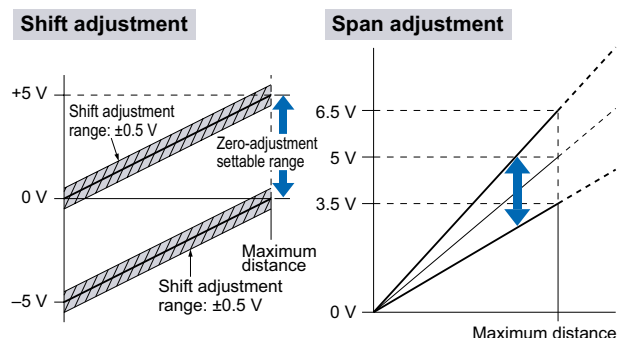

- FIBER SENSORS
- LASER SENSORS
- PHOTOELECTRIC SENSORS
- MICRO PHOTOELECTRIC SENSORS
- AREA SENSORS
- SAFETY LIGHT CURTAINS / SAFETY COMPONENTS
- PRESSURE / FLOW SENSORS
- INDUCTIVE PROXIMITY SENSORS
- PARTICULAR USE SENSORS
- SENSOR OPTIONS
- SIMPLE WIRE- SAVING UNITS
- WIRE- SAVING SYSTEMS
- MEASUREMENT SENSORS
- STATIC CONTROL DEVICES
- LASER MARKERS
- PLC
- HUMAN MACHINE INTERFACES
- ENERGY MANAGEMENT SOLUTIONS
- FA COMPONENTS
- MACHINE VISION SYSTEMS
- UV CURING SYSTEMS

- Selection Guide
- Laser Displacement
- Magnetic Displacement
- Contact Displacement
- Collimated Beam Sensors
- Metal-sheet Double-feed Detection
- Digital Panel Controller
- Other Products

- GP-X
- GP-A

APPLICATIONS

Measuring gap between rollers

Fine gap measurement is possible to control the gap between rollers.

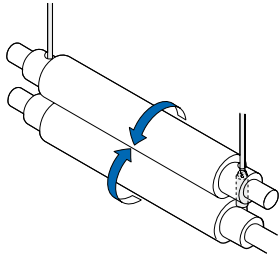

Measuring parallelism of chassis

Even a slight tilt can be reliably detected.

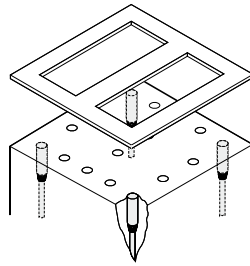

ORDER GUIDE

Type	Appearance (mm in)		Sensing range	Set model No.	Output
	Sensor heads	Amplifier			
For 1 mm 0.039 in sensing Non-threaded type sensor head Different frequency				<p>GP-A5S</p> <p>GP-A5SI</p>	<p>Analog voltage • Output voltage: 0 to 5 V</p> <p>Analog current • Output current: 4 to 20 mA</p>
For 2 mm 0.079 in sensing Threaded type sensor head Different frequency				<p>GP-A10M</p> <p>GP-A10MI</p>	
For 5 mm 0.197 in sensing Threaded type sensor head Different frequency				<p>GP-A12ML</p> <p>GP-A12MLI</p>	
For 3 mm 0.118 in sensing Front sensing type sensor head Different frequency				<p>GP-A14F</p> <p>GP-A14FI</p>	

Please ensure to order the sensor head and the amplifier as a set. The set is calibrated and delivered.

OPTIONS

Type	Model No.	Description
Sensor head mounting bracket	MS-SS5	Mounting bracket for GP-A5S(I)
	MS-SS8	Mounting bracket for GP-A8S(I)

Sensor head mounting bracket

- **MS-SS5**
- **MS-SS8**

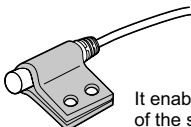

It enables easy fixing of the sensor head.

FIBER SENSORS

LASER SENSORS

PHOTO-ELECTRIC SENSORS

MICRO PHOTO-ELECTRIC SENSORS

AREA SENSORS

SAFETY LIGHT CURTAINS / SAFETY COMPONENTS

PRESSURE / FLOW SENSORS

INDUCTIVE PROXIMITY SENSORS

PARTICULAR USE SENSORS

SENSOR OPTIONS

SIMPLE WIRE-SAVING UNITS

WIRE-SAVING SYSTEMS

MEASURE-MENT SENSORS

STATIC CONTROL DEVICES

LASER MARKERS

PLC

HUMAN MACHINE INTERFACES

ENERGY MANAGEMENT SOLUTIONS

FA COMPONENTS

MACHINE VISION SYSTEMS

UV CURING SYSTEMS

Selection Guide

Laser Displacement

Magnetic Displacement

Contact Displacement

Collimated Beam Sensors

Metal-sheet Double-feed Detection

Digital Panel Controller

Other Products

GP-X

GP-A

SPECIFICATIONS

Type	For 1 mm 0.039 in sensing		For 2 mm 0.079 in sensing				For 5 mm 0.197 in sensing		For 3 mm 0.118 in sensing		
	Non-threaded type sensor head		Non-threaded type sensor head		Threaded type sensor head		Threaded type sensor head		Front sensing type sensor head		
	Different frequency		Different frequency		Different frequency		Different frequency		Different frequency		
Item	Set model No.	GP-A5S	GP-A5SI	GP-A8S	GP-A8SI	GP-A10M	GP-A10MI	GP-A12ML	GP-A12MLI	GP-A14F	GP-A14FI
Sensing range		0 to 1 mm 0 to 0.039 in		0 to 2 mm 0 to 0.079 in				0 to 5 mm 0 to 0.197 in		0 to 3 mm 0 to 0.118 in	
Standard sensing object		Iron sheet 8 × 8 × t 1 mm 0.315 × 0.315 × t 0.039 in		Iron sheet 12 × 12 × t 1 mm 0.472 × 0.472 × t 0.039 in				Iron sheet 30 × 30 × t 1 mm 1.181 × 1.181 × t 0.039 in		Iron sheet 15 × 15 × t 1 mm 0.591 × 0.591 × t 0.039 in	
Supply voltage		24 V DC ±10 % Ripple P-P 10 % or less									
Current consumption		150 mA or less									
Analog outputs (Analog voltage output) (Analog current output)		Analog voltage • Output voltage: 0 to 5 V • Output impedance: 100 Ω approx.					Analog current • Output current: 4 to 20 mA • Load resistance: 0 to 350 Ω				
Response frequency		1.6 kHz (–3 dB)									
Resolution		0.04 % F.S.									
Linearity		Within ±0.5 % F.S.									
Alarm output		NPN open-collector transistor • Maximum sink current: 100 mA • Applied voltage: 30 V DC or less (between alarm output and 0 V) • Residual voltage: 1.6 V or less (at 100 mA sink current) 0.4 V or less (at 16 mA sink current)									
Output operation		Turns ON when the sensor head connection is improper or the sensor head cable is disconnected									
Short-circuit protection		—									
External zero-adjustment input		Input condition: Non-voltage contact or NPN open-collector transistor input Signal condition: Low ... 0 to 1 V (duration 30 ms or more) High ... 5 to 30 V, or open Operation: Low ... External zero-adjustment setting High ... External zero-adjustment ineffective									
Zero-adjustment setting method		Push button setting / External input setting									
Power indicator		Green LED (lights up when the power is ON)									
Over indicator		Orange LED (lights up when sensing range is exceeded)									
Alarm indicator		Yellow LED (lights up when the alarm output is ON)									
Adjustments		① Shift adjustment (by push-buttons), ② Span adjustment (by 14-turn adjuster)									
Temperature characteristics (Note 2)	Sensor head	0.5 μm/°C 0.020 mil/°C	0.6 μm/°C 0.024 mil/°C	1 μm/°C 0.039 mil/°C	0.6 μm/°C 0.024 mil/°C	1 μm/°C 0.039 mil/°C	1.5 μm/°C 0.059 mil/°C	2.5 μm/°C 0.098 mil/°C	0.9 μm/°C 0.035 mil/°C	1.5 μm/°C 0.059 mil/°C	
	Amplifier	0.4 μm/°C 0.016 mil/°C		0.8 μm/°C 0.031 mil/°C			2.0 μm/°C 0.079 mil/°C		1.2 μm/°C 0.047 mil/°C		
Protection	Sensor head	IP67 (IEC), IP67G									
	Amplifier	—									
Ambient temperature	Sensor head	–10 to +55 °C +14 to +131 °F , Storage: –20 to +70 °C –4 to +158 °F									
	Amplifier	0 to +50 °C +32 to +122 °F (No dew condensation allowed), Storage: 0 to +50 °C +32 to +122 °F									
Ambient humidity		35 to 85 % RH, Storage: 35 to 85 % RH									
Voltage withstandability	Sensor head	250 V AC for one min. between all supply terminals connected together and enclosure									
Insulation resistance	Sensor head	20 MΩ, or more, with 250 V DC megger between all supply terminals connected together and enclosure									
Vibration resistance	Sensor head	10 to 55 Hz frequency, 1.5 mm 0.059 in double amplitude in X, Y and Z directions for two hours each									
	Amplifier	10 to 150 Hz frequency, 0.75 mm 0.030 in double amplitude in X, Y and Z directions for two hours each									
Shock resistance	Sensor head	500 m/s ² acceleration (50 G approx.) in X, Y and Z directions five times each									
	Amplifier	100 m/s ² acceleration (10 G approx.) in X, Y and Z directions five times each									
Material	Sensor head	Enclosure: Stainless steel (SUS303) Sensing part: Polyallylate		Enclosure: Stainless steel (SUS303) Sensing part: ABS			Enclosure: Brass (Nickel plated) Sensing part: Nylon		Enclosure: Stainless steel (SUS303) Sensing part: ABS		
	Amplifier	Enclosure: ABS									
Cable	Sensor head	Connector attached high frequency coaxial cable, 3 m 9.843 ft long									
Cable length (Note 3)	Amplifier	Total length up to 100 m 328.084 ft is possible with 0.3mm ² , or more, cable.									
Net Weight	Sensor head	40 g approx.				50 g approx. (Note 4)		45 g approx. (Note 4)		50 g approx.	
	Amplifier	170 g approx.									
Accessories		Adjusting screwdriver: 1 pc.				Nut: 2 pcs., Toothed lock washer: 1 pc. Adjusting screwdriver: 1 pc.				2 pcs. each of M3 countersunk head screws, spring washers, plain washers and M3 nuts Adjusting screwdriver: 1 pc.	

Notes: 1) Where measurement conditions have not been specified precisely, the conditions used were an ambient temperature of +20 °C **+68 °F**.

2) These values are for a range which is 20 to 60 % of the maximum sensing distance.

3) Take care that the output voltage is reduced due to the resistance of the wiring cable.

4) The given weight of the threaded type sensor head is the value including the weight of the nuts and the toothed lock washer.

I/O CIRCUIT AND WIRING DIAGRAMS

I/O circuit diagram

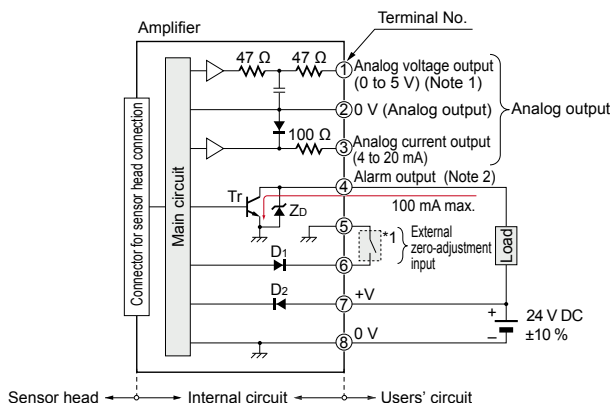

- Notes: 1) In case of using the analog voltage output, connect a device having a high input impedance. Also, take care that the output voltage is reduced due to the resistance of the wiring cable.
 2) The alarm output is not incorporated with a short-circuit protection circuit. Do not connect it directly to a power supply or a capacitive load.

Symbols ... D1: Input protection diode
 D2: Reverse supply polarity protection diode
 Zb: Surge absorption zener diode
 Tr: NPN output transistor

Wiring diagram

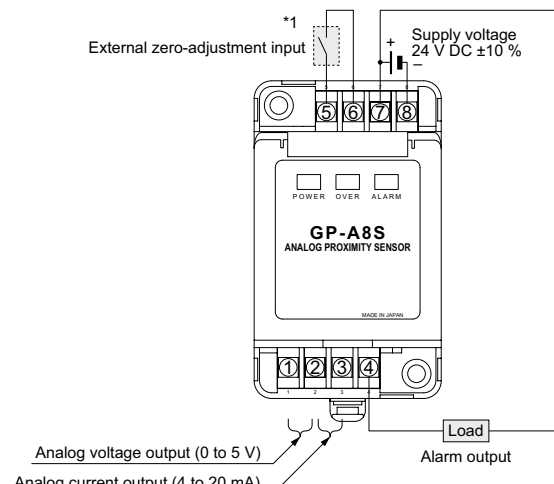

Note: After the wiring, make sure to fit the terminal cover. The terminal cover having a concave depression at the top should be fitted on the side having terminal Nos. 1 to 4.

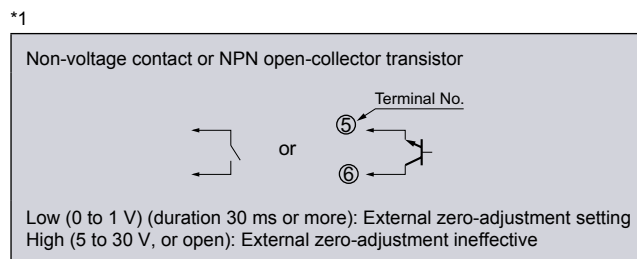

SENSING CHARACTERISTICS (TYPICAL)

Correlation between material and output voltage / current

The GP-A series is made for all types of standard iron sensing objects. The graph below describes the output discrepancies that occur when detecting different types of metals.

GP-A5S(I)

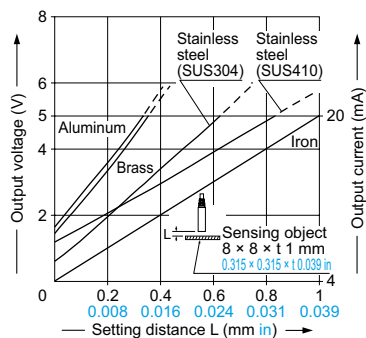

GP-A8S(I) GP-A10M(I)

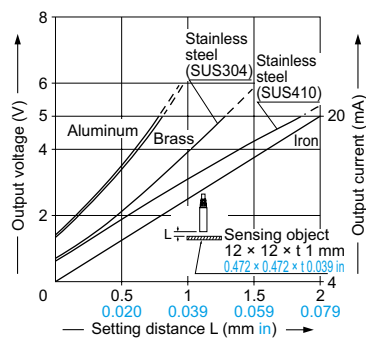

GP-A12ML(I)

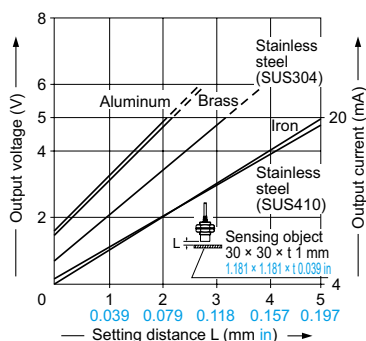

GP-A14F(I)

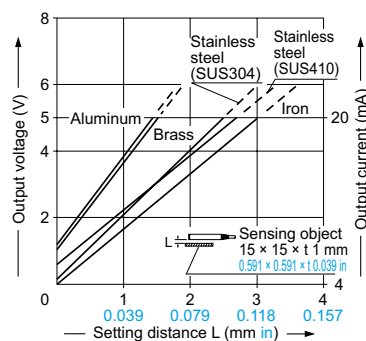

FIBER SENSORS

LASER SENSORS

PHOTO-ELECTRIC SENSORS

MICRO PHOTO-ELECTRIC SENSORS

AREA SENSORS

SAFETY LIGHT CURTAINS / SAFETY COMPONENTS

PRESSURE / FLOW SENSORS

INDUCTIVE PROXIMITY SENSORS

PARTICULAR USE SENSORS

SENSOR OPTIONS

WIRE-SAVING UNITS

WIRE-SAVING SYSTEMS

MEASURE-MENT SENSORS

STATIC CONTROL DEVICES

LASER MARKERS

PLC

HUMAN MACHINE INTERFACES

ENERGY MANAGEMENT SOLUTIONS

FA COMPONENTS

MACHINE VISION SYSTEMS

UV CURING SYSTEMS

Selection Guide

Laser Displacement

Magnetic Displacement

Contact Displacement

Collimated Beam Sensors

Metal-sheet Double-feed Detection

Digital Panel Controller

Other Products

GP-X

GP-A

PRECAUTIONS FOR PROPER USE

Refer to p.1595 for general precautions.



- Never use this product as a sensing device for personnel protection.
- In case of using sensing devices for personnel protection, use products which meet laws and standards, such as OSHA, ANSI or IEC etc., for personnel protection applicable in each region or country.

- Make sure to use in combination the sensor head and amplifier which have the same production serial number (5 digits). Since adjustment is done before shipment, if items with different production serial numbers are combined, the sensing characteristics will deteriorate even if they have the same model number.
- The length of the sensor head cable cannot be changed.

Linearity in case of disc-shaped or cylindrical objects

- In case the sensing object is disc-shaped or cylindrical, the linearity of the analog output varies with the sensing object size. In such a case, conduct zero adjustment when close mounting and, by adjusting to the maximum sensing distance and to 5 V as the voltage output (current output 20 mA), linearity ($\pm 0.5\%$ F.S.) can be attained on a full-scale if the sensing object's size is larger than those described in the table below.

Model No.	Iron disc diameter ϕ (mm in)	Iron cylinder diameter ϕ (mm in)
GP-A5S(I)	12 0.472	10 0.394
GP-A8S(I)	12 0.472	10 0.394
GP-A10M(I)	12 0.472	10 0.394
GP-A12ML(I)	30 1.118	50 1.969
GP-A14F(I)	12 0.472	10 0.394

<In case of disc>

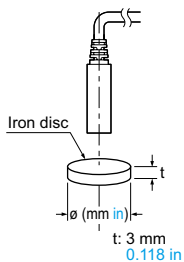

<In case of cylinder>

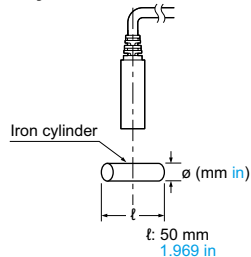

Mounting sensor head

Mounting with set screw

- The tightening torque should be under the value given below.
- Make sure to use an M3 or smaller set screw having a cup-point.

<Non-threaded type sensor head>

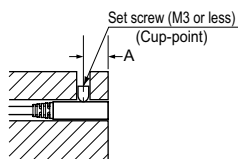

Model No.	A (mm in)	Tightening torque
GP-A5S(I)	5 0.197	0.44 N·m
GP-A8S(I)	5 or more	0.58 N·m

Note: Do not apply excess torque.

Mounting with nut

- The tightening torque should be under the value given below.

<Threaded type sensor head>

GP-A10M(I)	GP-A12ML(I)	Model No.	B (mm in)	Tightening torque
		GP-A10M(I)	7 0.276 or more	9.8 N·m
		GP-A12ML(I)	14 0.551 or more	20 N·m

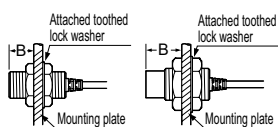

Note: Install in such a way so that the nut does not protrude from the screw.

Mounting GP-A14(I)

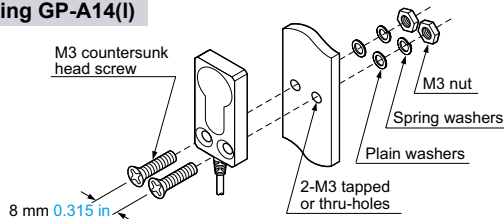

Distance from surrounding metal

- As metal around the sensor may affect the sensing performance, pay attention to the following points.

<Embedding of the sensor in metal>

- Since the analog output may change if the sensor is completely embedded in metal, keep the minimum distance specified in the table below.

(Non-threaded type sensor head)
(threaded type sensor head)

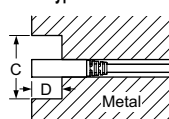

<Front sensing type sensor head>

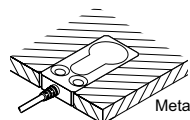

Model No.	C (mm in)	D (mm in)
GP-A5S(I)	$\phi 18$ $\phi 0.709$	4 0.157
GP-A8S(I)		7 0.276
GP-A10M(I)	$\phi 50$ $\phi 1.969$	14 0.551
GP-A12ML(I)		

- **GP-A14F(I)** can be used by being completely embedded in metal. However, the surrounding metal should not protrude beyond the sensing face.

Mutual interference

- When two or more sensor heads are installed in parallel or face to face, since the specifications may not be met, keep the minimum separation distance specified in the table below.

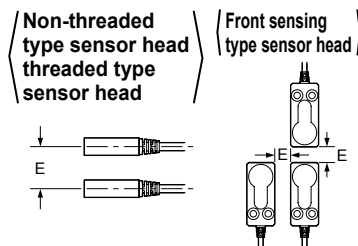

Model No.	E (mm in)	
	Between "I" type and non-"I" type	Between two "I" types or two non-"I" types
GP-A5S(I)	11 0.433	36 1.417
GP-A8S(I)	11 0.433	38 1.496
GP-A10M(I)		
GP-A12ML(I)	14 0.551	130 5.118
GP-A14F(I)	0 0	30 1.181

Notes: 1) "I" type is different frequency type.
2) If the required resolution is lower than the specification (0.04 % F.S.), it is possible to bring the sensor heads nearer than the separation distances given in the table above. For further details, please contact our office.

Dimensions of suitable crimp terminals

(Unit: mm in)

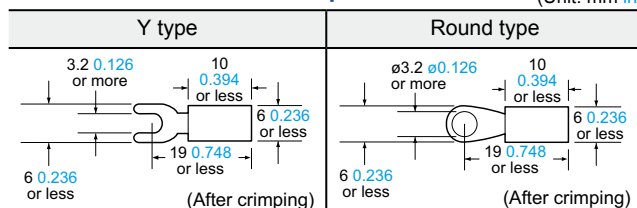

Note: Please use crimp terminals which have insulation sleeves.
Recommended crimp terminal: Type 1.25 - 3.0

Others

- Do not use during the initial transient time (0.5 sec.) after the power supply is switched on.
- Do not use the sensor at places having intense vibrations, as this can cause malfunction.

FIBER SENSORS
LASER SENSORS
PHOTO-ELECTRIC SENSORS
MICRO PHOTO-ELECTRIC SENSORS
AREA SENSORS
SAFETY LIGHT CURTAINS / SAFETY COMPONENTS
PRESSURE / FLOW SENSORS
INDUCTIVE PROXIMITY SENSORS
PARTICULAR USE SENSORS
SENSOR OPTIONS
SIMPLE WIRE-SAVING UNITS
WIRE-SAVING SYSTEMS
MEASURE-MENT SENSORS
STATIC CONTROL DEVICES
LASER MARKERS
PLC
HUMAN MACHINE INTERFACES
ENERGY MANAGEMENT SOLUTIONS
FA COMPONENTS
MACHINE VISION SYSTEMS
UV CURING SYSTEMS

Selection Guide
Laser Displacement
Magnetic Displacement
Contact Displacement
Collimated Beam Sensors
Metal-sheet Double-feed Detection
Digital Panel Controller
Other Products
GP-X
GP-A

