

37V/2.5A Microstepping Motor Driver

FEATURES

- Built-in decoder for micro steps
 (2 phase excitation, half-step, 1-2 phase excitation, W1-2 phase excitation and 2W1-2 phase excitation)
 Stepping motor can be driven by only external clock signal.
- PMW can be driven by built-in CR (3-value can be selected during PWM OFF period.)
 Selection during PWM OFF period enables the best PWM drive.
- Mix Decay compatible (4-value for Fast Decay ratio can be selected.)
 Mix Decay control can improve accuracy of motor current wave form.
- Built -in low voltage detection
 If supply voltage lowers less than the range of operating supply voltage, low voltage detection operates and all phases of motor drive output are turned OFF.
- Built-in thermal protection
 If chip junction temperature rises and reaches setup temperature, all phases of motor drive output are turned OFF.

- 1 power supply with built-in 5 V power supply (accuracy $\pm 5\%$)
 Motor can be driven by only 1 power supply because of built-in 5 V power supply.
- Built-in standby function
 Operation of standby function can lower current consumption of LSI.
- Built-in Home Position function
 Home Position function can detect the position of a motor.
- 34 pin Plastic Small Outline Package With Heat Sink (SOP Type)

DESCRIPTION

AN44067A is a two channel H-bridge driver LSI. Bipolar stepping motor can be controlled by a single driver LSI. 2 phase excitation, half- step, 1-2 phase excitation, W1-2 phase excitation and 2W1-2 phase excitation can be selected.

APPLICATIONS

- LSI for stepping motor drives

SIMPLIFIED APPLICATION

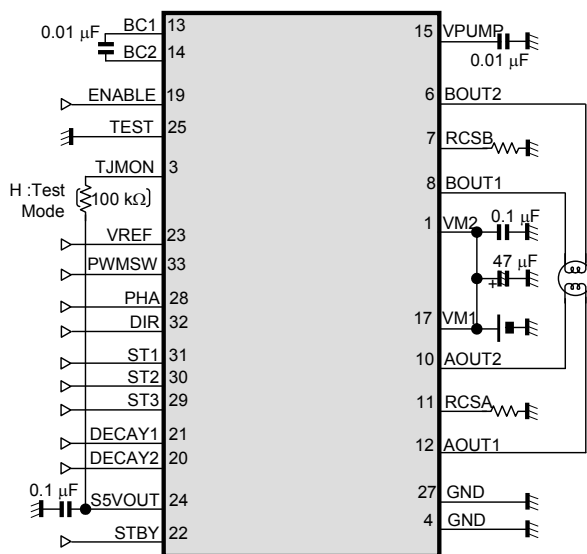

Notes)
 This application circuit is an example. The operation of mass production set is not guaranteed. You should perform enough evaluation and verification on the design of mass production set. You are fully responsible for the incorporation of the above application circuit and information in the design of your equipment.

Mix Decay effect for Motor current

【Fig1:Slow Decay】

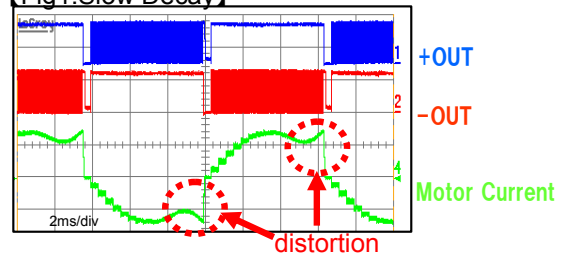

【Fig2:Mix Decay(25%)】

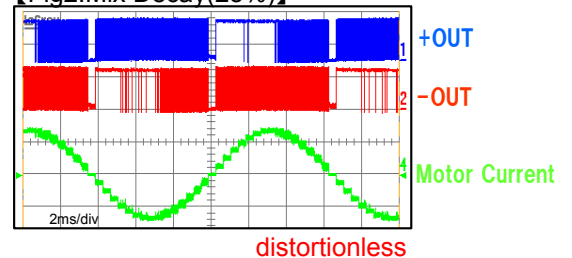

Condition:
 excitation mode : 2W1-2 phase drive
 fig1 DECAY1=L DECAY2=L
 fig2 DECAY1=L DECAY2=H

ABSOLUTE MAXIMUM RATINGS

Parameter	Symbol	Rating	Unit	Note
Supply voltage	V_M	37	V	*1
Power dissipation	P_D	0.466	W	*2
Operating ambient temperature	T_{opr}	-20 to +70	°C	*3
Operating junction temperature	T_j	-20 to +150	°C	*3
Storage temperature	T_{stg}	-55 to +150	°C	*3
Output pin voltage (Pin 6, 8, 10, 12)	V_{OUT}	37	V	*4
Motor drive current (Pin 6, 8, 10, 12)	I_{OUT}	±2.5	A	*5,*6
Flywheel diode current (Pin 6, 8, 10, 12)	I_f	2.5	A	*5,*6
Input Voltage Range	V_{RCSA}, V_{RCSB}	2.5	V	—
	V_{BC2}	(VM-1) to 43	V	*7
	V_{VPUMP}	(VM-2) to 43	V	*7
	V_{ENABLE}	-0.3 to 6	V	—
	V_{DECAY1}, V_{DECAY2}	-0.3 to 6	V	—
	V_{STBY}	-0.3 to 6	V	—
	V_{VREF}	-0.3 to 6	V	—
	V_{TEST}	-0.3 to 6	V	—
	V_{PHA}	-0.3 to 6	V	—
	$V_{ST1}, V_{ST2}, V_{ST3}$	-0.3 to 6	V	—
	V_{DIR}	-0.3 to 6	V	—
	V_{PWMSW}	-0.3 to 6	V	—
	I_{TJMON}	1	mA	*8
	I_{S5VOUT}	-7 to 0	mA	—
ESD	HBM (Human Body Model)	± 2	kV	—
	CDM (Charge Device Model)	± 1	kV	—

Notes). This product may sustain permanent damage if subjected to conditions higher than the above stated absolute maximum rating.

This rating is the maximum rating and device operating at this range is not guaranteeable as it is higher than our stated recommended operating range. When subjected under the absolute maximum rating for a long time, the reliability of the product may be affected.

*1 : The values under the condition not exceeding the above absolute maximum ratings and the power dissipation.

*2 : The power dissipation shown is the value at $T_a = 70^\circ \text{C}$ for the independent (unmounted) LSI package without a heat sink.

When using this LSI, refer to the PD- T_a diagram of the package standard and design the heat radiation with sufficient margin so that the allowable value might not be exceeded based on the conditions of power supply voltage, load, and ambient temperature.

*3 : Except for the power dissipation, operating ambient temperature, and storage temperature, all ratings are for $T_a = 25^\circ \text{C}$.

*4 : This is output voltage rating and do not apply input voltage from outside to these pins. Set not to exceed allowable range at any time.

*5 : Do not apply external currents to any pin specially mentioned. For circuit currents, (+) denotes current flowing into the LSI and (-) denotes current flowing out of the LSI.

*6 : Rating when cooling fin on the back side of the LSI is connected to the GND pattern of the glass epoxy 4-layer board. (GND area : 2nd-layer or 3rd-layer : more than 1500 mm²) In case of no cooling fin on the back side of the LSI, rating current is 1.5 A on the glass epoxy 2-layer board.

*7 : These are pins not applied voltage from outside. Set so that the rating must not be exceeded transiently.

*8 : In case of TEST = High-level input, TJMON voltage is only Low-level.

POWER DISSIPATION RATING

Condition	θ_{JA}	PD (Ta=25 °C)	PD (Ta=70 °C)
Mount on PWB *1	86.0 °C/W	1453mW	930mW
Without PWB	171.6 °C/W	728mW	466mW

Note). For the actual usage, please refer to the PD-Ta characteristics diagram in the package specification, supply voltage, load and ambient temperature conditions to ensure that there is enough margin follow the power and the thermal design does not exceed the allowable value.

*1: Glass-Epoxy: 50×50×0.8 (mm) , heat dissipation fin: Dai-pad , the state where it does not mount.



CAUTION

Although this has limited built-in ESD protection circuit, but permanent damage may occur on it. Therefore, proper ESD precautions are recommended to avoid electrostatic damage to the MOS gates

RECOMMENDED OPERATING CONDITIONS

Parameter	Symbol	Min.	Typ.	Max.	Unit	Note
Supply voltage range	VM1,VM2	10	24	34	V	*1
Input Voltage Range	V_{ENABLE}	0	-	5.5	V	—
	V_{DECAY1}, V_{DECAY2}	0	-	5.5	V	—
	V_{STBY}	0	-	5.5	V	—
	V_{VREF}	0	-	5	V	—
	V_{TEST}	0	-	5.5	V	—
	V_{PHA}	0	-	5.5	V	—
	$V_{ST1}, V_{ST2}, V_{ST3}$	0	-	5.5	V	—
	V_{DIR}	0	-	5.5	V	—
	V_{PWMSW}	0	-	5.5	V	—
External Constants	C_{BC}	-	0.01	-	μF	—
	C_{VPUMP}	-	0.01	-	μF	—
	C_{S5VOUT}	-	0.1	-	μF	—
Operating ambient temperature	Ta^{opr}	-20	-	70	°C	—
Operating junction temperature	Tj^{opr}	-	-	120	°C	—

Note) *1 : The values under the condition not exceeding the above absolute maximum ratings and the power dissipation.

ELECTRICAL CHARACTERISTICS

VM=24V, Ta = 25°C±2°C unless otherwise noted.

*1 : Typical Value checked by design.

Parameter	Symbol	Condition	Limits			Unit	Note
			Min	Typ	Max		
Output Drivers							
High-level output saturation voltage	V _{OH}	I = -1.2 A	V _M -0.75	V _M -0.42	—	V	—
Low-level output saturation voltage	V _{OL}	I = 1.2 A	—	0.54	0.825	V	—
Flywheel diode forward voltage	V _{DI}	I = 1.2 A	0.5	1.0	1.5	V	—
Output leakage current	I _{LEAK}	V _M = 37 V, V _{RCS} = 0 V	—	10	20	μA	—
Supply current (Active)	I _M	ENABLE = High, STBY = High	—	5.5	10	mA	—
Supply current (STBY)	I _{MSTBY}	STBY = Low	—	25	50	μA	—
Output slew rate 1	VT _r	Output voltage rise	—	220	—	V/μs	*1
Output slew rate 2	VT _f	Output voltage fall	—	200	—	V/μs	*1
Dead time	T _D	—	—	0.8	—	μs	*1
I/O Block							
High-level STBY input voltage	V _{STBYH}	—	2.1	—	5.5	V	—
Low-level STBY input voltage	V _{STBYL}	—	0	—	0.6	V	—
High-level STBY input current	I _{STBYH}	STBY = 5 V	25	50	100	μA	—
Low-level STBY input current	I _{STBYL}	STBY = 0 V	-2	—	2	μA	—
High-level PHA input voltage	V _{PHAH}	—	2.1	—	5.5	V	—
Low-level PHA input voltage	V _{PHAL}	—	0	—	0.6	V	—
High-level PHA input current	I _{PHAH}	PHA = 5 V	25	50	100	μA	—
Low-level PHA input current	I _{PHAL}	PHA = 0 V	-2	—	2	μA	—
Highest-level PHA input frequency	f _{PHA}	—	—	—	100	kHz	—
High-level ENABLE input voltage	V _{ENABLEH}	—	2.1	—	5.5	V	—
Low-level ENABLE input voltage	V _{ENABLEL}	—	0	—	0.6	V	—
High-level ENABLE input current	I _{ENABLEH}	ENABLE = 5 V	25	50	100	μA	—
Low-level ENABLE input current	I _{ENABLEL}	ENABLE = 0 V	-2	—	2	μA	—
High-level PWMSW input voltage	V _{PWMSWH}	—	2.3	—	5.5	V	—
Middle-level PWMSW input voltage	V _{PWMSWM}	—	1.3	—	1.7	V	—
Low-level PWMSW input voltage	V _{PWMSWL}	—	0	—	0.6	V	—
High-level PWMSW input current	I _{PWMSWH}	PWMSW = 5 V	40	83	150	μA	—
Low-level PWMSW input current	I _{PWMSWL}	PWMSW = 0 V	-70	-36	-18	μA	—

ELECTRICAL CHARACTERISTICS (continued)

VM=24V, T_a = 25°C±2°C unless otherwise noted.

Parameter	Symbol	Condition	Limits			Unit	Note
			Min	Typ	Max		
I/O Block (Continued)							
PWMSW voltage at open	V _{PWMSWO}	—	1.3	1.5	1.7	V	—
High-level DECA Y input voltage	V _{DECA YH}	—	2.1	—	5.5	V	—
Low-level DECA Y input voltage	V _{DECA YL}	—	0	—	0.6	V	—
High-level DECA Y input current	I _{DECA YH}	DECA Y1 = DECA Y2 = 5 V	25	50	100	μA	—
Low-level DECA Y input current	I _{DECA YL}	DECA Y1 = DECA Y2 = 0 V	-2	—	2	μA	—
High-level DIR input voltage	V _{DIRH}	—	2.1	—	5.5	V	—
Low-level DIR input voltage	V _{DIRL}	—	0	—	0.6	V	—
High-level DIR input current	I _{DIRH}	DIR = 5 V	25	50	100	μA	—
Low-level DIR input current	I _{DIRL}	DIR = 0 V	-2	—	2	μA	—
High-level ST input voltage	V _{STH}	—	2.1	—	5.5	V	—
Low-level ST input voltage	V _{STL}	—	0	—	0.6	V	—
High-level ST input current	I _{STH}	ST1 = ST2 = ST3 = 5 V	25	50	100	μA	—
Low-level ST input current	I _{STL}	ST1 = ST2 = ST3 = 0 V	-2	—	2	μA	—
High-level TEST input voltage	V _{TESTH}	—	4.0	—	5.5	V	—
Middle-level TEST input voltage	V _{TESTM}	—	2.3	—	2.7	V	—
Low-level Test input voltage	V _{TESTL}	—	0	—	0.6	V	—
High-level TEST input current	I _{TESTH}	TEST = 5 V	25	50	100	μA	—
Low-level TEST input current	I _{TESTL}	TEST = 0 V	-2	—	2	μA	—
Torque Control Block							
Input bias current 1	I _{REFH}	V _{REF} = 5 V	-15	—	5	μA	—
Input bias current 2	I _{REFL}	V _{REF} = 0 V	-2	—	2	μA	—
PWM OFF time 1	T _{OFF1}	PWMSW = Low	16.8	28	39.2	μs	—
PWM OFF time 2	T _{OFF2}	PWMSW = Middle	9.1	15.2	21.3	μs	—
PWM OFF time 3	T _{OFF3}	PWMSW = High	4.9	8.1	11.3	μs	—
Pulse blanking time	T _B	V _{REF} = 0 V	0.4	0.7	1.0	μs	—
Comp threshold	V _{T_{CMP}}	V _{REF} = 5 V	475	500	525	mV	—
Reference Voltage Block							
Reference voltage	V _{S5VOUT}	I _{S5VOUT} = 0 mA	4.75	5.0	5.25	V	—
Output impedance	Z _{S5VOUT}	I _{S5VOUT} = -7 mA	—	—	10	Ω	—

ELECTRICAL CHARACTERISTICS (continued)

VM=24V, T_a = 25°C±2°C unless otherwise noted.

Parameter	Symbol	Condition	Limits			Unit	Note
			Min	Typ	Max		
Home Position Block							
At TEST High-level input TJMON output Low-level voltage	V _{TJL}	Pull up TJMON pin to 5 V with 100 kΩ.	—	0.1	0.3	V	—
At TEST High-level input TJMON output leakage current	I _{TJ(leak)}	V _{TJMON} = 5 V	—	—	5	μA	—
Thermal Protection							
Thermal protection operating temperature	TSD _{on}	—	—	150	—	°C	*1
Thermal protection hysteresis width	ΔTSD	—	—	40	—	°C	*1
Low voltage Protection							
Protection operating voltage	V _{UVLO1}	—	—	7.9	—	V	*1
Protection releasing voltage	V _{UVLO2}	—	—	8.7	—	V	*1

*1 : Typical Value checked by design.

PIN CONFIGURATION

Top View

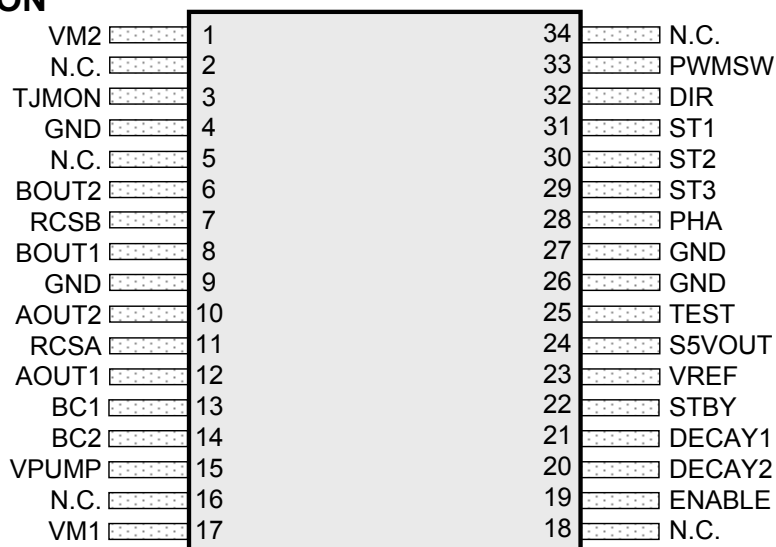

PIN FUNCTIONS

Pin No.	Pin name	Type	Description
1	VM2	Power supply	Motor power supply 2
2, 5, 16, 18, 34	N.C.	—	No Connection
3	TJMON	Output	VBE monitor / Test output / Home Position output
4, 9, 26, 27	GND	Ground	ground
6	BOUT2	Output	Phase B motor drive output 2
7	RCSB	Input / Output	Phase B current detection
8	BOUT1	Output	Phase B motor drive output 1
10	AOUT2	Output	Phase A motor drive output 2
11	RCSA	Input / Output	Phase A current detection
12	AOUT1	Output	Phase A motor drive output 1
13	BC1	Output	Charge pump capacitor connection 1
14	BC2	Output	Charge pump capacitor connection 2
15	VPUMP	Output	Charge pump circuit output
17	VM1	Power supply	Motor power supply 1
19	ENABLE	Input	Enable / disable CTL
20	DECAY2	Input	Mix Decay setup 2
21	DECAY1	Input	Mix Decay setup 1
22	STBY	Input	Standby
23	VREF	Input	Torque reference voltage input
24	S5VOUT	Output	Internal reference voltage (output 5 V)
25	TEST	Input	Test mode
28	PHA	Input	Clock input
29	ST3	Input	Step select 3
30	ST2	Input	Step select 2
31	ST1	Input	Step select 1
32	DIR	Input	Rotation direction
33	PWMSW	Input	PWM OFF period selection input

Note) Concerning detail about pin description, please refer to OPERATION and APPLICATION INFORMATION section.

FUNCTIONAL BLOCK DIAGRAM

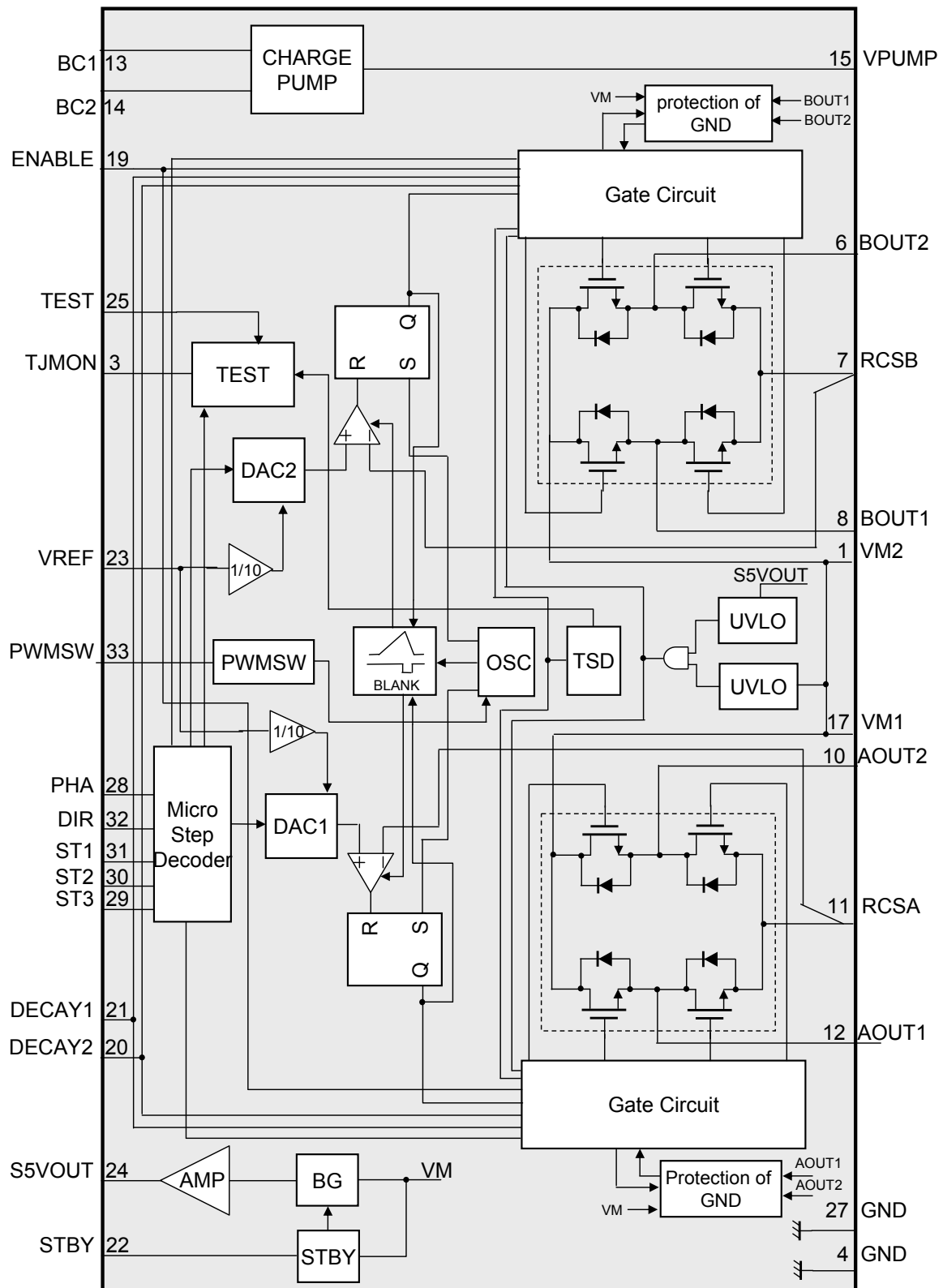

Note) This block diagram is for explaining functions. Part of the block diagram may be omitted, or it may be simplified.

OPERATION

1. Control mode

1) Truth table (Step select)

ENABLE	DIR	ST1	ST2	ST3	Output excitation mode (Phase B 90° delay : to Phase A)
High	—	—	—	—	Output OFF
Low	Low	Low	Low	Low	2 phase excitation drive (4-step sequence)
Low	Low	Low	High	Low	Half-step drive (8-step sequence)
Low	Low	High	Low	Low	1-2 phase excitation drive (8-step sequence)
Low	Low	High	High	Low	W1-2 phase excitation drive (16-step sequence)
Low	Low	—	—	High	2W1-2 phase excitation drive (32-step sequence)

ENABLE	DIR	ST1	ST2	ST3	Output excitation mode (Phase B 90° advance : to Phase A)
High	—	—	—	—	Output OFF
Low	High	Low	Low	Low	2 phase excitation drive (4-step sequence)
Low	High	Low	High	Low	Half-step drive (8-step sequence)
Low	High	High	Low	Low	1-2 phase excitation drive (8-step sequence)
Low	High	High	High	Low	W1-2 phase drive (16-step sequence)
Low	High	—	—	High	2W1-2 phase drive (32-step sequence)

2) Truth table (Control/Charge pump circuit)

STBY	ENABLE	Control /Charge pump circuit	Output transistor
Low	—	OFF	OFF
High	High	ON	OFF
High	Low	ON	ON

3) Truth table (PWM OFF period selection)

PWMSW	PWM OFF period
Low	28.0 μs
Middle	15.2 μs
High	8.1 μs

4) Truth table (Decay selection)

DECAY1	DECAY2	Decay control
Low	Low	Slow Decay
Low	High	25%
High	Low	50%
High	High	100%

5) Truth table (Test mode)

TEST	TJMON
Low	VBE monitor
Middle	Test output (Output transistor : OFF)
High	Home Position output

Note) For each PWM OFF period, Fast Decay is applied according to the above table.

OPERATION (continued)

2. Each phase current value

1) 1-2 phase, W1-2 phase, 2W1-2 phase DIR = Low

Note) The definition of Phase A and B current "100%" : $(VREF \times 0.1) / \text{Current detection resistance}$

1-2 phase (8 Step)	W1-2 phase (16 Step)	2W1-2 phase (32 Step)	Phase A current (%)	Phase B current (%)
		1	19.5	-98.1
	1	2	38.3	-92.4
		3	55.6	-83.2
1	2	4	70.7	-70.7
		5	83.2	-55.6
	3	6	92.4	-38.3
		7	98.1	-19.5
2	4	8	100	0
		9	98.1	19.5
	5	10	92.4	38.3
		11	83.2	55.6
3	6	12	70.7	70.7
		13	55.6	83.2
	7	14	38.3	92.4
		15	19.5	98.1
4	8	16	0	100
		17	-19.5	98.1
	9	18	-38.3	92.4
		19	-55.6	83.2
5	10	20	-70.7	70.7
		21	-83.2	55.6
	11	22	-92.4	38.3
		23	-98.1	19.5
6	12	24	-100	0
		25	-98.1	-19.5
	13	26	-92.4	-38.3
		27	-83.2	-55.6
7	14	28	-70.7	-70.7
		29	-55.6	-83.2
	15	30	-38.3	-92.4
		31	-19.5	-98.1
8	16	32	0	-100

OPERATION (continued)

2. Each phase current value (continued)

2) 1-2 phase, W1-2 phase, 2W1-2 phase DIR = High

Note) The definition of Phase A and B current "100%" : $(VREF \times 0.1) / \text{Current detection resistance}$

1-2 phase (8 Step)	W1-2 phase (16 Step)	2W1-2 phase (32 Step)	Phase A current (%)	Phase B current (%)
		1	-19.5	-98.1
	1	2	-38.3	-92.4
		3	-55.6	-83.2
1	2	4	-70.7	-70.7
		5	-83.2	-55.6
	3	6	-92.4	-38.3
		7	-98.1	-19.5
2	4	8	-100	0
		9	-98.1	19.5
	5	10	-92.4	38.3
		11	-83.2	55.6
3	6	12	-70.7	70.7
		13	-55.6	83.2
	7	14	-38.3	92.4
		15	-19.5	98.1
4	8	16	0	100
		17	19.5	98.1
	9	18	38.3	92.4
		19	55.6	83.2
5	10	20	70.7	70.7
		21	83.2	55.6
	11	22	92.4	38.3
		23	98.1	19.5
6	12	24	100	0
		25	98.1	-19.5
	13	26	92.4	-38.3
		27	83.2	-55.6
7	14	28	70.7	-70.7
		29	55.6	-83.2
	15	30	38.3	-92.4
		31	19.5	-98.1
8	16	32	0	-100

OPERATION (continued)

3. Each phase current (Timing chart)

1) 2 phase excitation drive (4-step sequence)

(ST1 = Low, ST2 = Low, ST3 = Low)

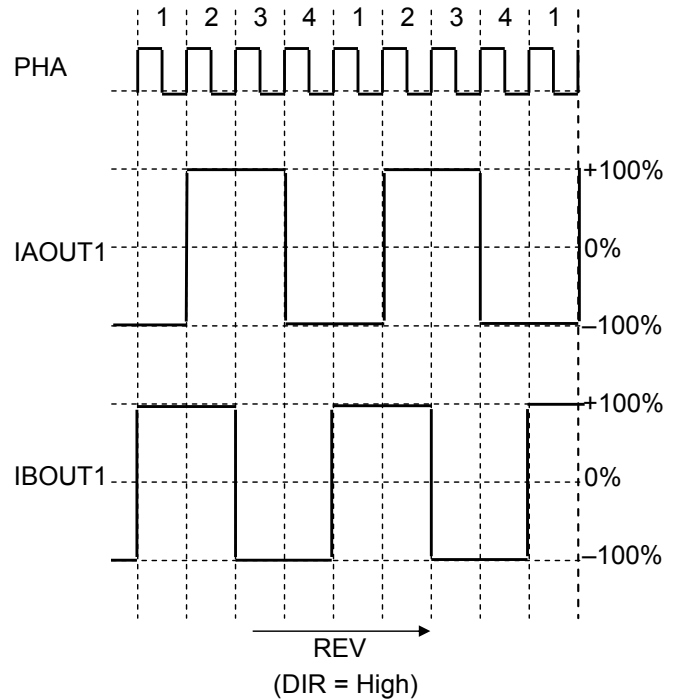
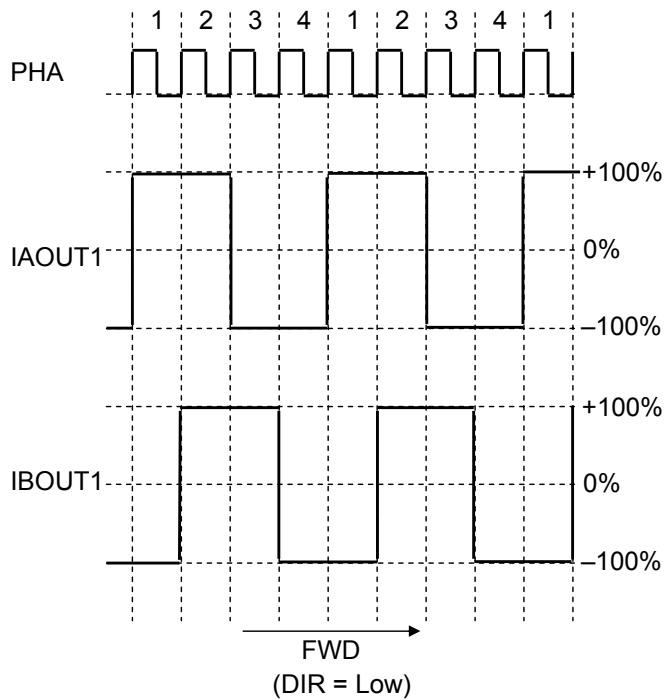

2) Half-step drive (8-step sequence)

(ST1 = Low, ST2 = High, ST3 = Low)

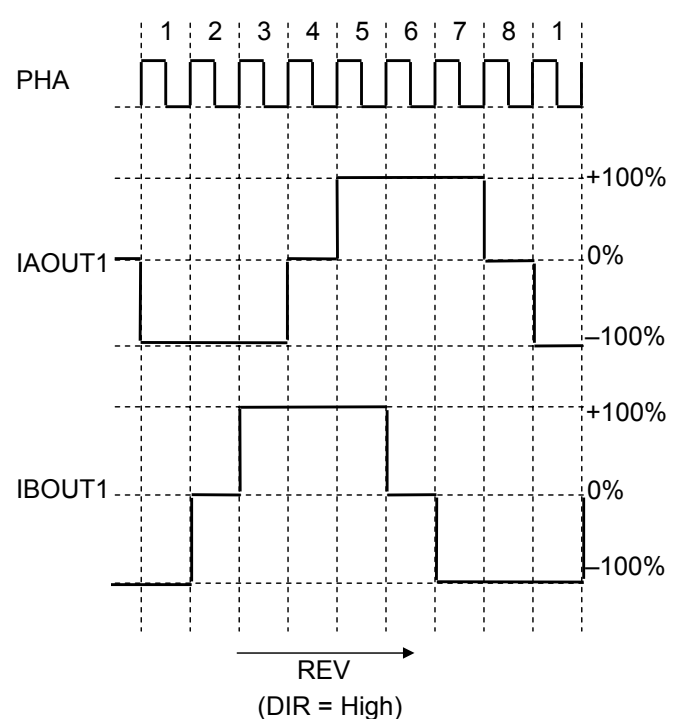
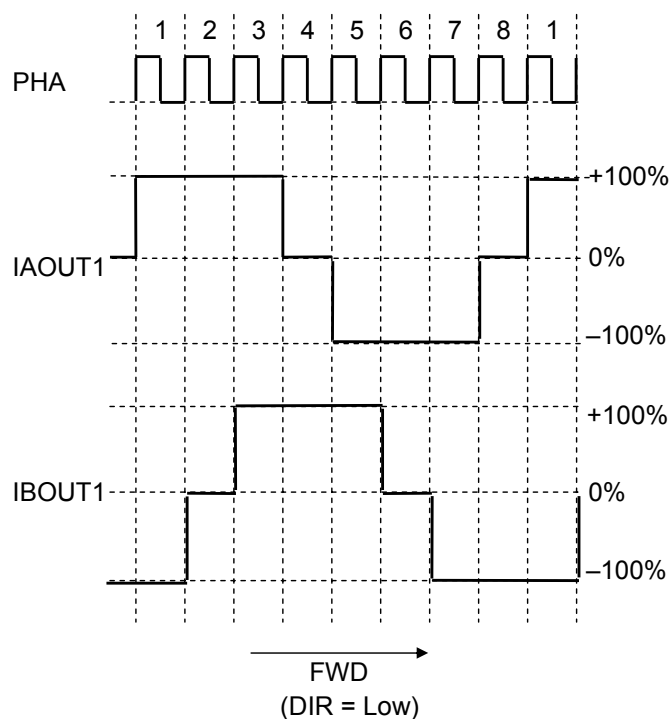

OPERATION (continued)

3.Each phase current (Timing chart) (continued)

3) 1-2 phase excitation (8-step sequence)

(ST1 = High, ST2 = Low, ST3 = Low)

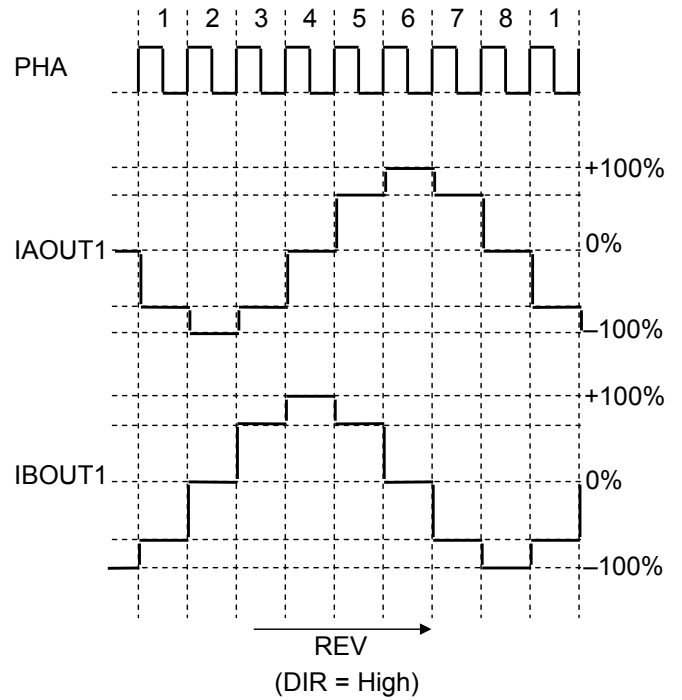
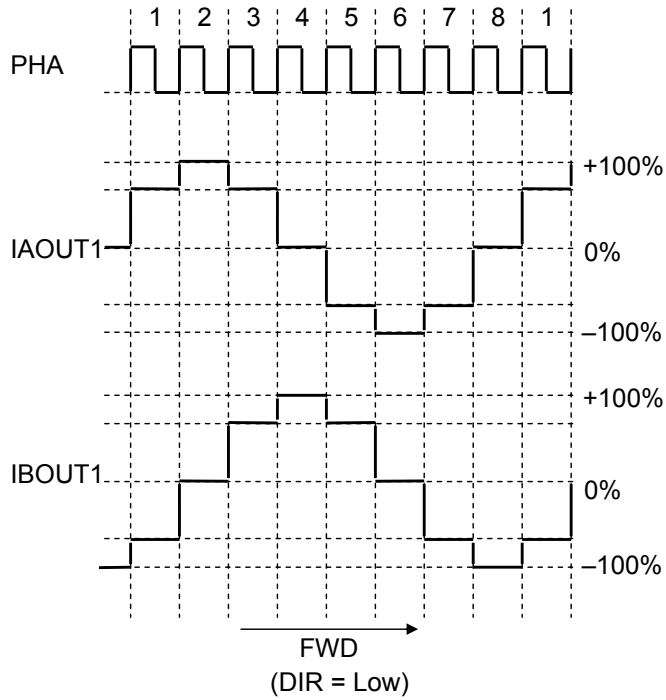

OPERATION (continued)

3.Each phase current (Timing chart) (continued)

4) W1-2 phase excitation (16-step sequence)
 (ST1 = High, ST2 = High, ST3 = Low)

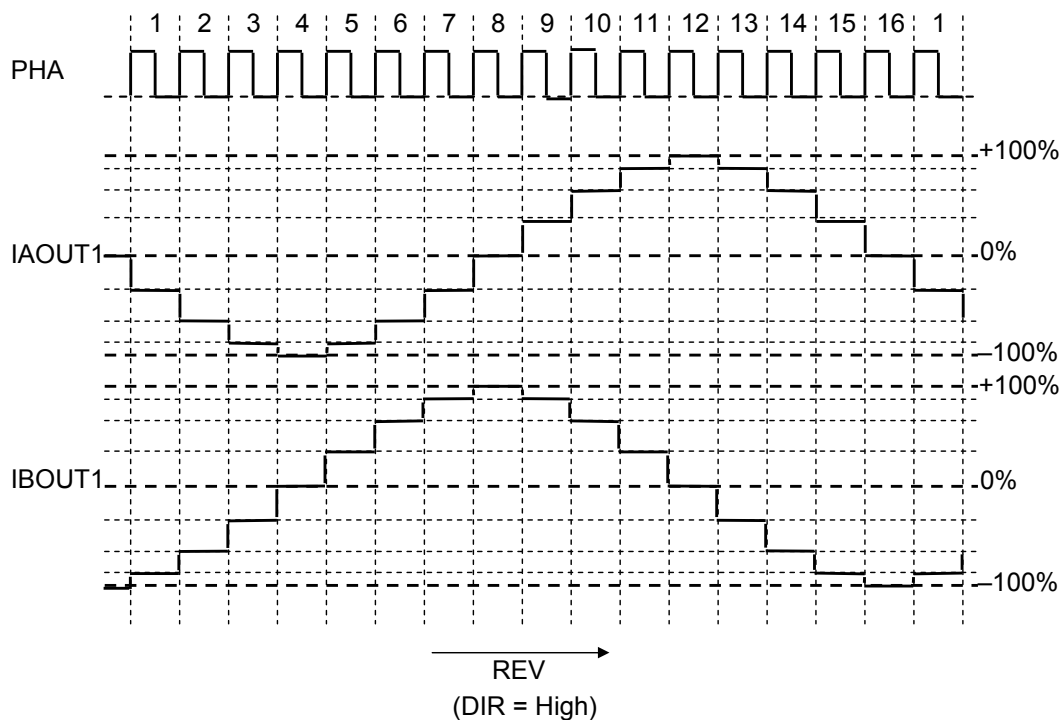
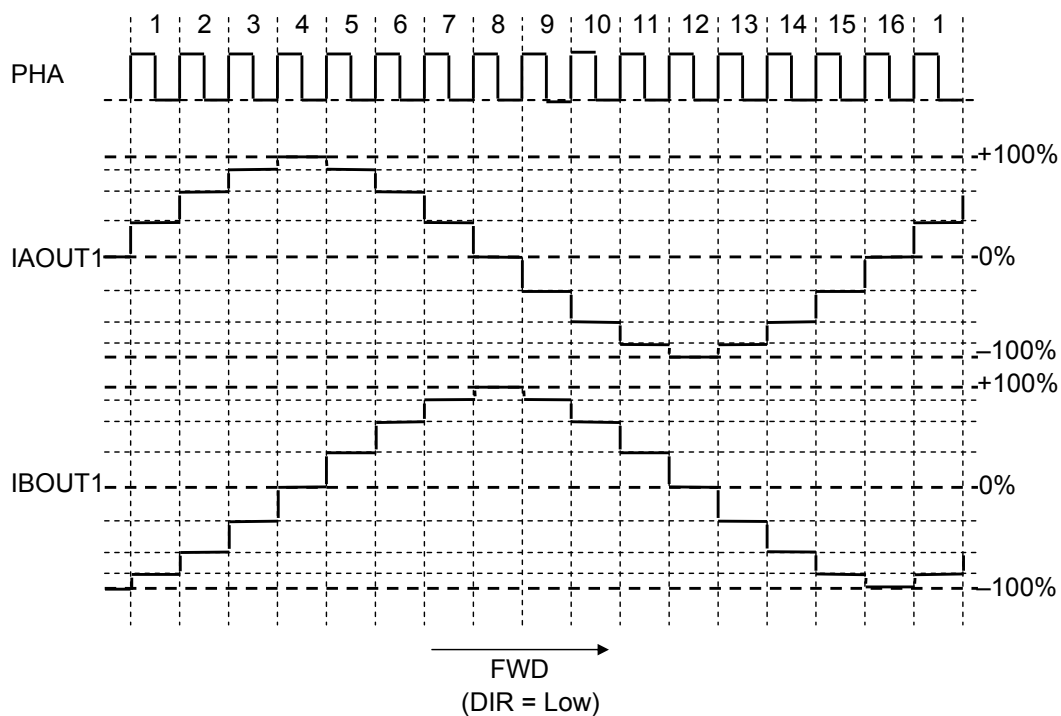

OPERATION (continued)

3.Each phase current (Timing chart) (continued)

5) 2W1-2 phase excitation (32-step sequence)

(ST3 = High)

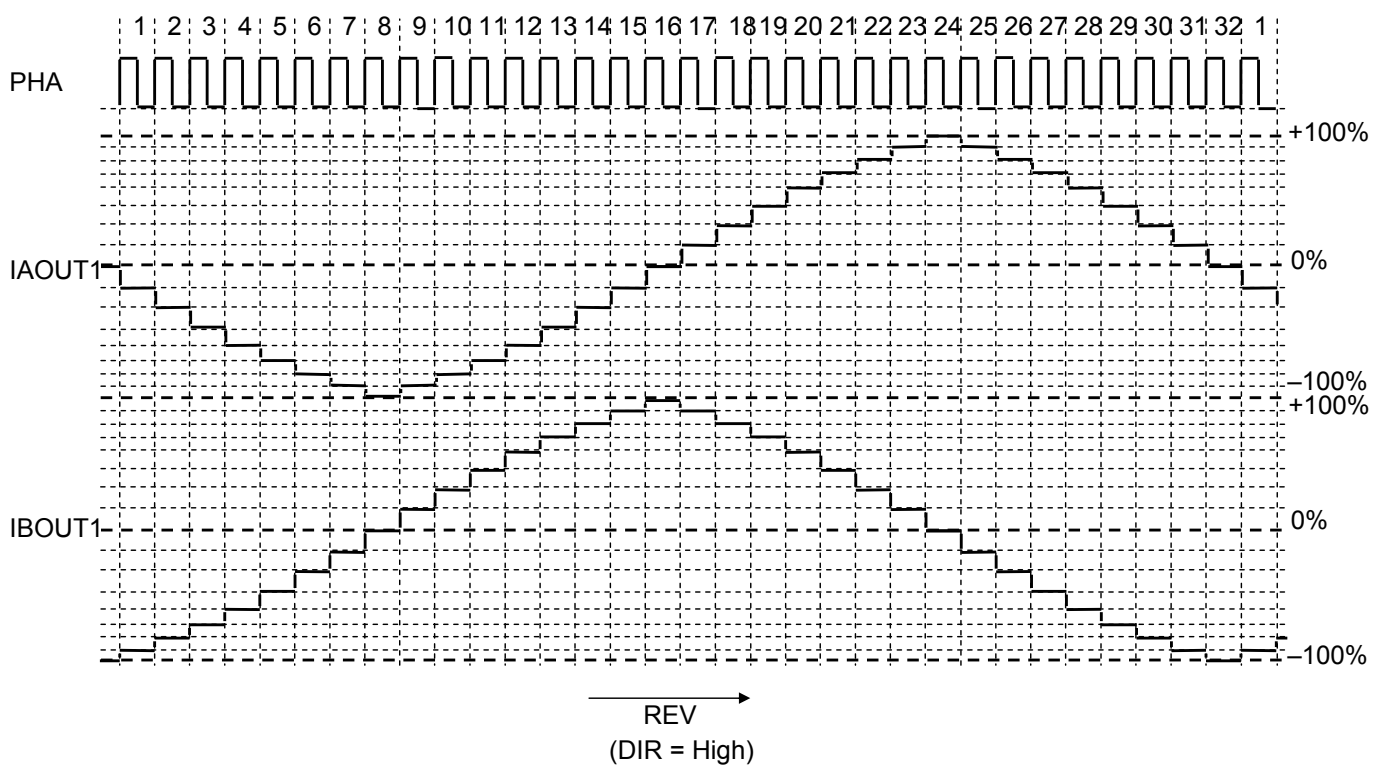
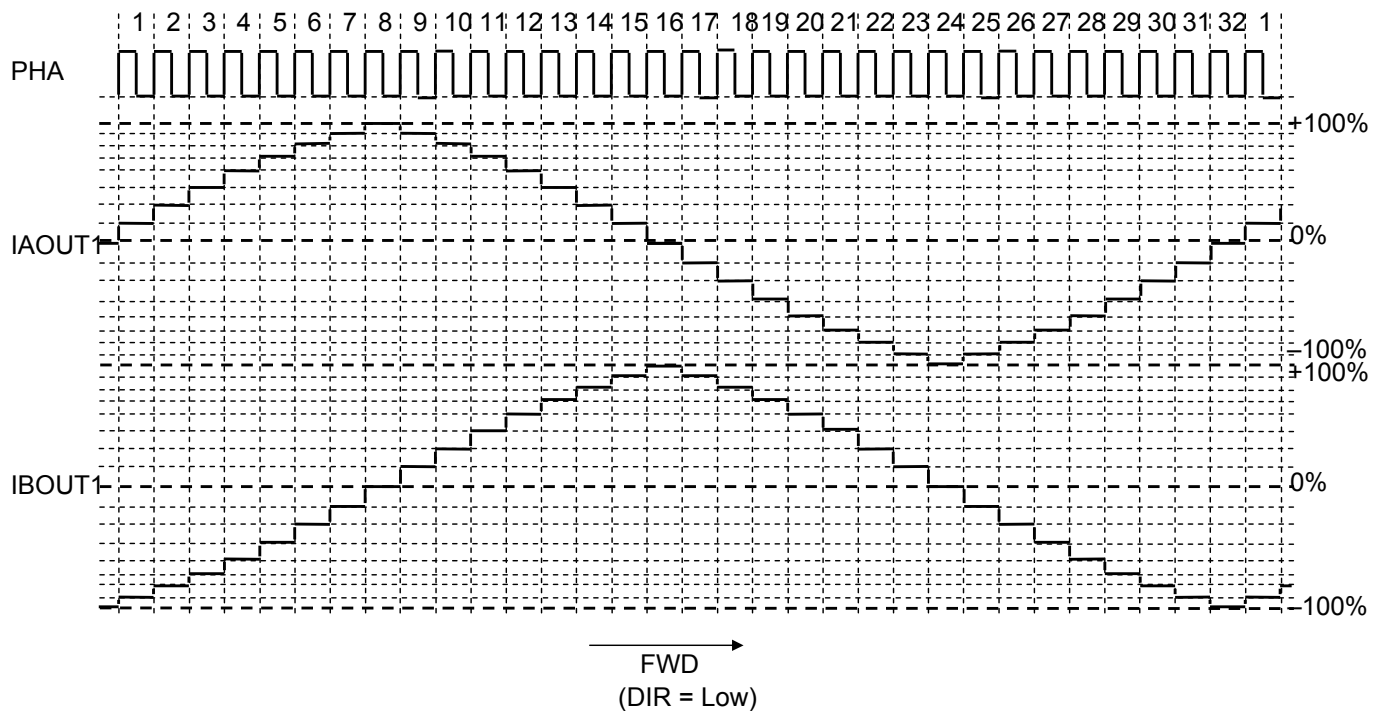

OPERATION (continued)

4. Timing chart at change of DIR

(Ex.1) Timing chart at 1-2 phase excitation (DIR : Low → High)

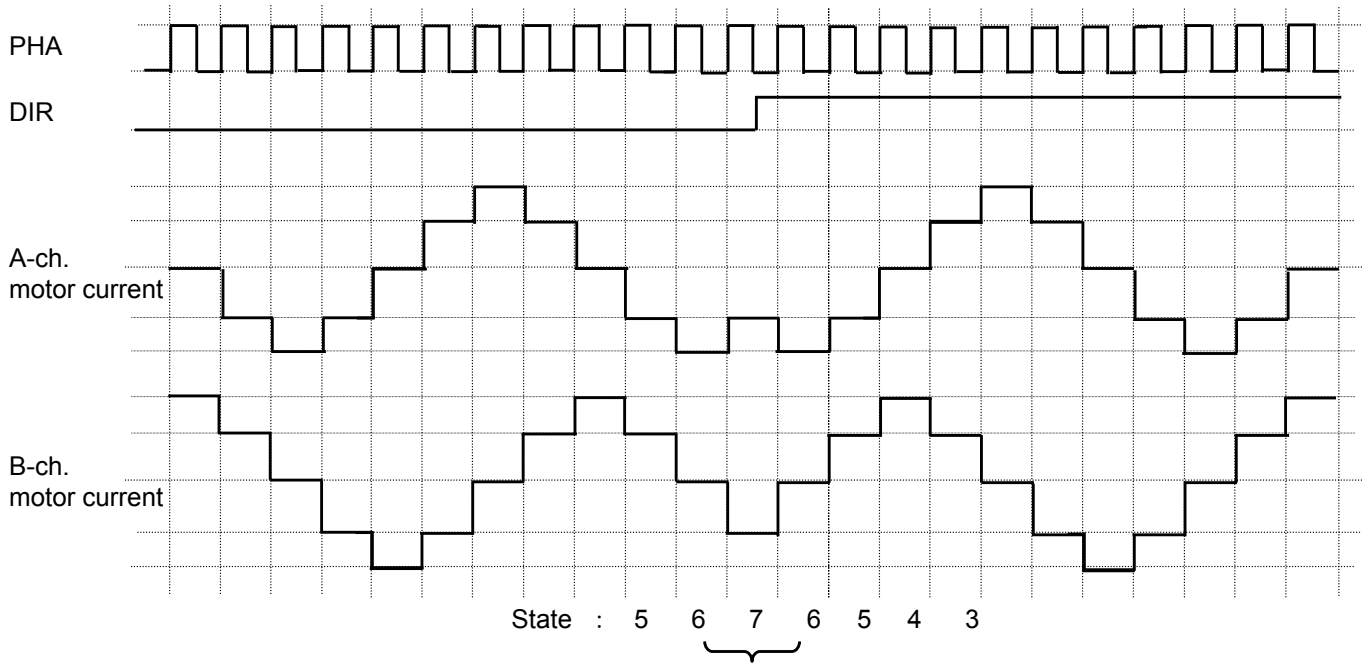

At change of DIR, the state before the change is held and the operation is continued.

(Ex.2) Timing chart at 1-2 phase excitation (DIR : High → Low)

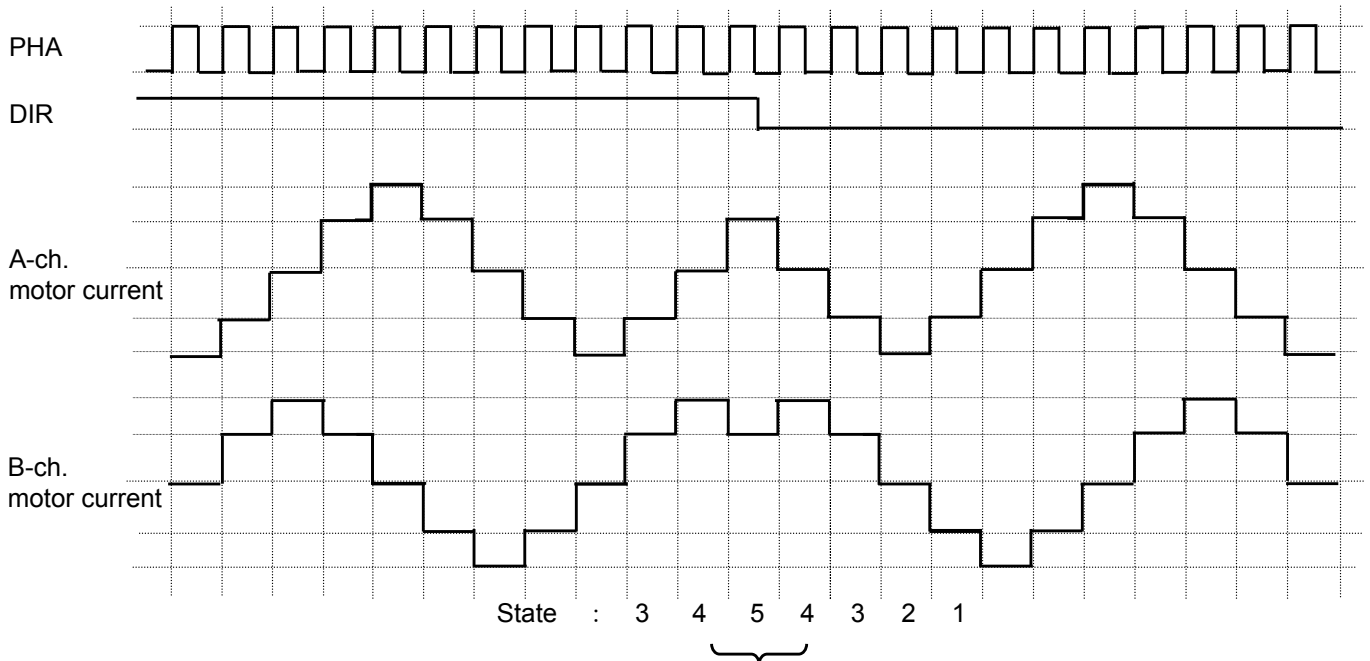

At change of DIR, the state before the change is held and the operation is continued.

OPERATION (continued)

5.Home Position function

This LSI has built-in Home Position function to reduce the displacement of motor current state at change of excitation mode while a motor is driving.

Home Position function , following as the below chart, outputs Low-level voltage to TJMON pin at the timing when the displacement of motor current state is minimum at change of excitation mode in case of TEST = High-level input.

At other timing, Home Position function outputs High-level voltage (in case the pull-up resistor (recommendation : 100 kΩ to 5 V) is connected because TJMON pin is made with open drain) at TJMON pin.

1) Home Position output timing chart (DIR = Low)

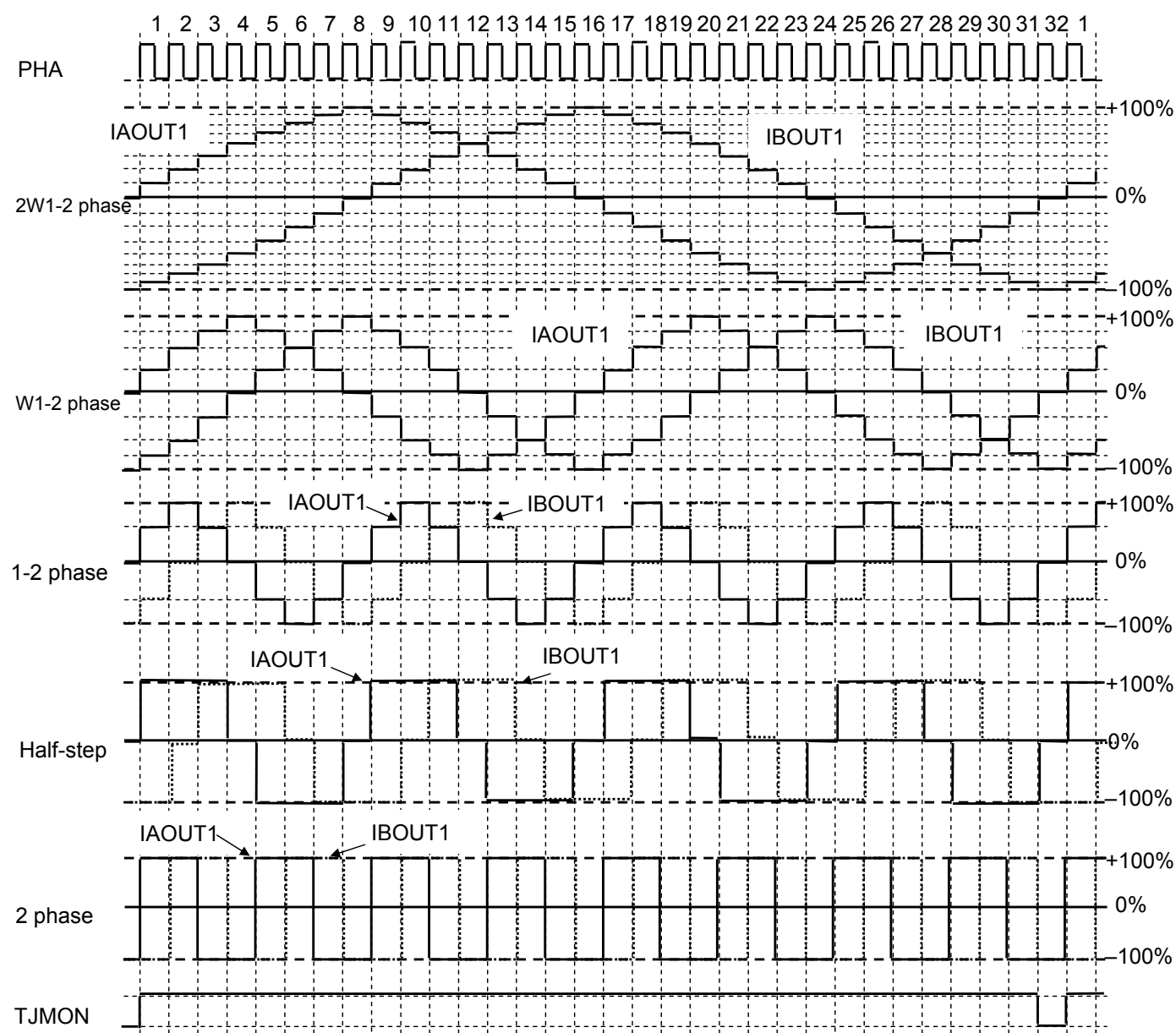

Table Output current of each excitation mode at Home Position = Low (DIR = Low)

	2 phase excitation	Half-step	1-2 phase excitation	W1-2 phase excitation	2W1-2 phase excitation
Phase A current	-100%	0%	0%	0%	0%
Phase B current	-100%	-100%	-100%	-100%	-100%

OPERATION (continued)

5.Home Position function (continued)

2) Home Position output timing chart (DIR = High)

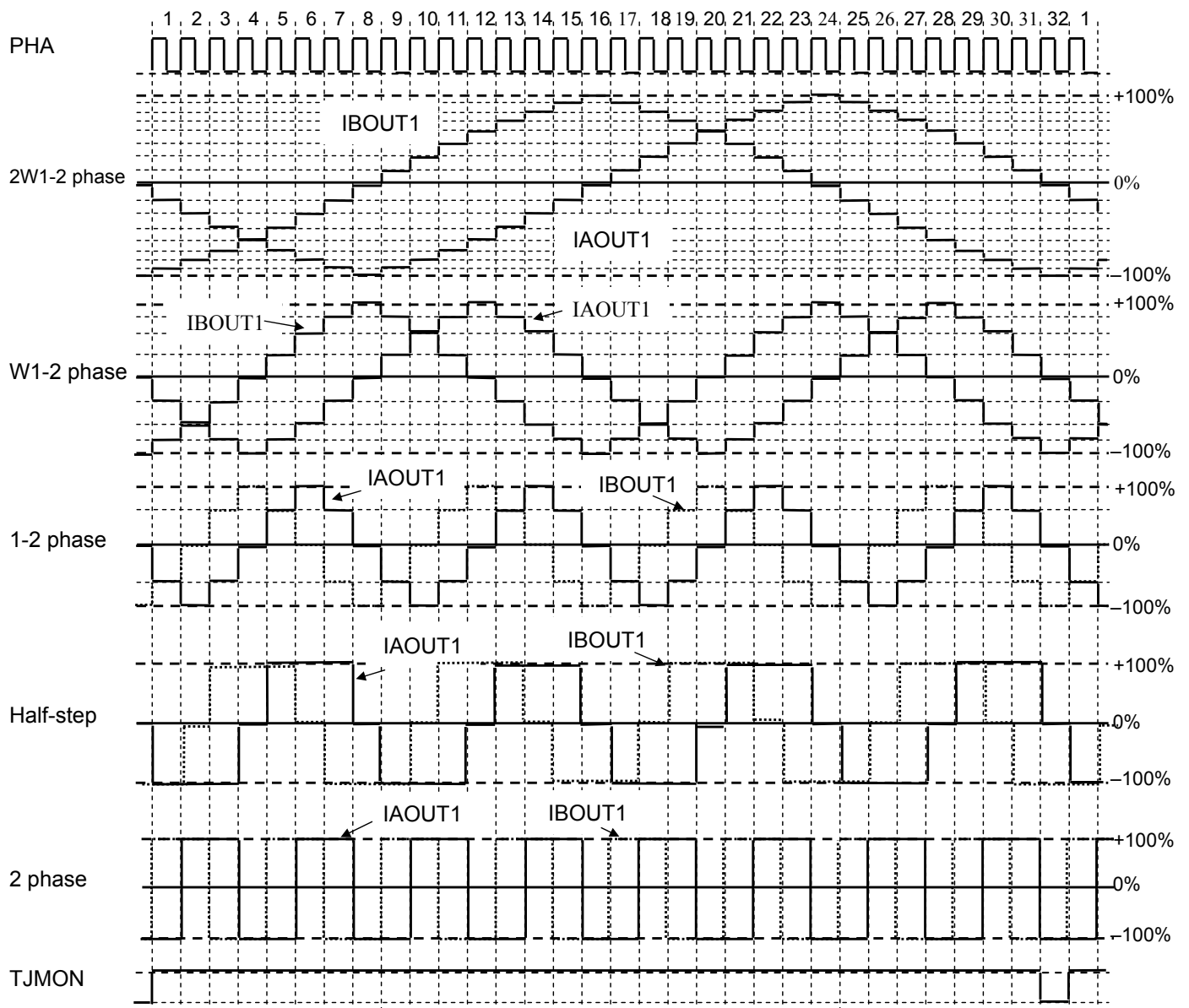

Table Output current of each excitation mode at Home Position = Low (DIR = High)

	2 phase excitation	Half-step	1-2 phase excitation	W1-2 phase excitation	2W1-2 phase excitation
Phase A current	-100%	0%	0%	0%	0%
Phase B current	-100%	-100%	-100%	-100%	-100%

APPLICATIONS INFORMATION

1. Notes

1) Pulse blanking time

This LSI has pulse blanking time (0.7 μ s/Typ. value) to prevent erroneous current detection caused by noise. Therefore, the motor current value will not be less than current determined by pulse blanking time. Pay attention at the time of minimum current control.

The relation between pulse blanking time and minimum current value is shown as Chart 1.

In addition, increase-decrease of motor current value is determined by L value, wire wound resistance, induced voltage and PWM on Duty inside a motor.

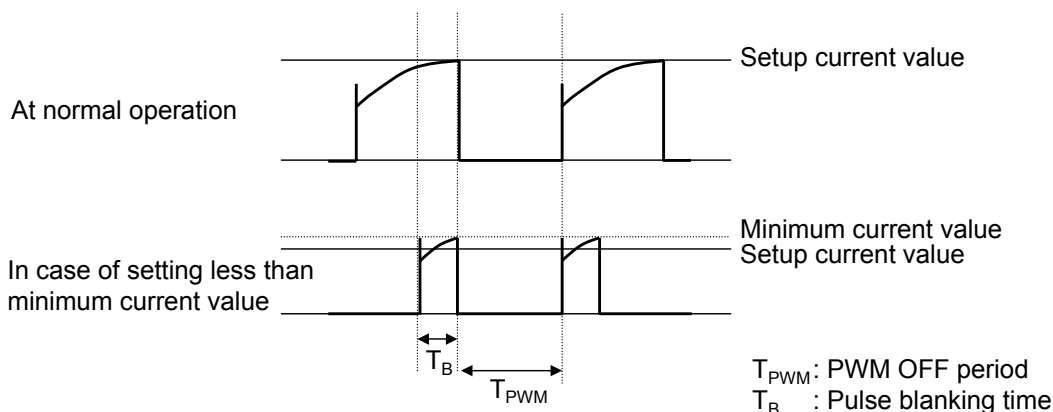

Chart 1. RCS current waveform

2) VREF voltage

When VREF voltage is set to Low-level, erroneous detection of current might be caused by noise because threshold of motor current detection comparator becomes low (= $V_{REF}/10 \times$ motor current ratio [%]). Use this LSI after confirming no misdetection with setup REF voltage.

3) Notes on interface

Absolute maximum of Pin 19 to Pin 23 and Pin 28 to Pin 33 is -0.3 V to 6 V. When the setup current for a motor is large and lead line of GND is long, GND pin potential might rise. Take notice that interface pin potential is negative to difference in potential between GND pin reference and interface pin in spite of inputting 0 V to the interface pin. At that time, pay attention allowable voltage range must not be exceeded.

4) Notes on test mode

When inputting voltage of above 0.6 V and below 4.0 V to TEST (Pin 25), this LSI might become test mode. When disturbance noise etc. makes this LSI test mode, motor output pin might be Hi-Z. Therefore, use this LSI on condition that TEST pin is shorted to GND or S5VOUT at normal motor operation.

APPLICATIONS INFORMATION (continued)

1. Notes (continued)

5) Notes on Standby mode release / Low voltage protection release

This LSI has all phases OFF period of about 140 μ s (typ) owing to release of Standby and Low voltage protection (Refer to the below figure).

This is why restart from Standby and Low voltage protection is performed after booster voltage rises sufficiently because booster operation stops at Standby and Low voltage protection.

When the booster voltage does not rise sufficiently during all phases OFF period due to that capacitance voltage between VPUMP and GND becomes large etc., the LSI might overheat. In this case, release Standby and Low voltage protection at ENABLE = High-level, and restart at ENABLE = Low-level after the booster voltage rises sufficiently.

Moreover, take notice that state of motor current becomes default position at Standby and Low voltage protection operation following as 1. Notes No.8.

[At Standby release]

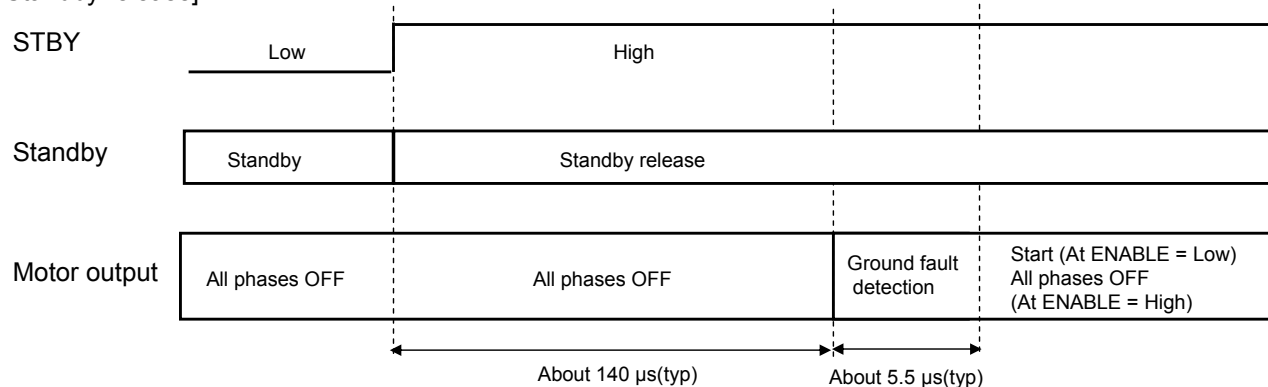

[At Low voltage protection release]

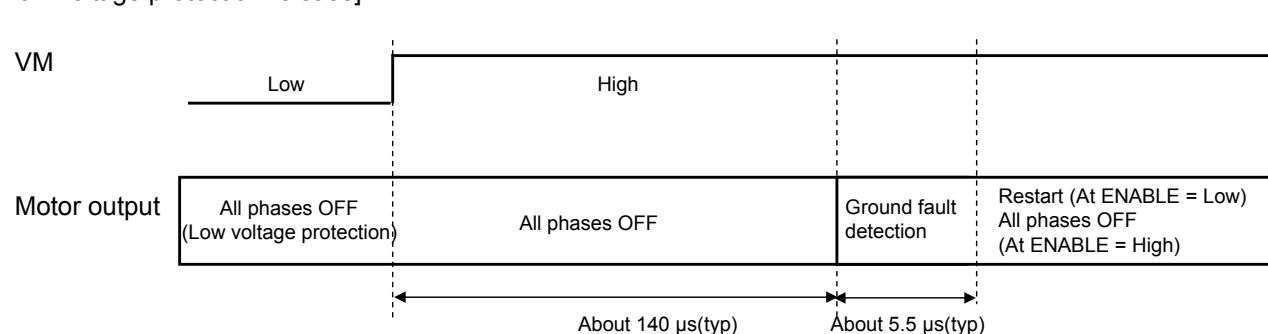

6) Ground fault protection function

This LSI has built-in ground fault protection function to detect ground fault of motor output pin at board mounting. As the above figure, ground fault detection function will operate after release of Low voltage protection and Standby, and check ground fault of motor output pins. If ground fault is detected, this function makes motor output all phases OFF and motor operation stop.

If ground fault is not detected, this function makes motor start. However, take notice that LSI might be destroyed before ground fault protection function operates in case that ASO (Area of Safe Operation) of device or maximum rating are exceeded in a moment.

In addition, this function might not detect ground fault when starting VM at STBY = High-level. It is recommended that VM is started at STBY = Low-level.

In case of release of ground fault detection, restart LSI after inputting low voltage to STBY pin or making VM voltage OFF.

7) Notes on release of thermal protection

The release of thermal protection operation will restart after all phases OFF of about 140 μ s and ground fault detection operation as 1. Notes No.5, 6.

Moreover, take notice that the state of motor current will become default position after release of thermal protection operation as 1. Notes No.8

APPLICATIONS INFORMATION (continued)

1. Notes (continued)

8) Default of motor current state

Default of motor current follows as the below figure after release of Low voltage protection, Standby and thermal protection on each excitation mode.

Table default position of each excitation mode

Excitation mode	Default electrical angle
2 phase excitation (4 step)	- 45°
Half-step (8 step)	0°
1-2 phase excitation (8 step)	0°
W1-2 phase excitation (16 step)	0°
2W1-2 phase excitation (32 step)	0°

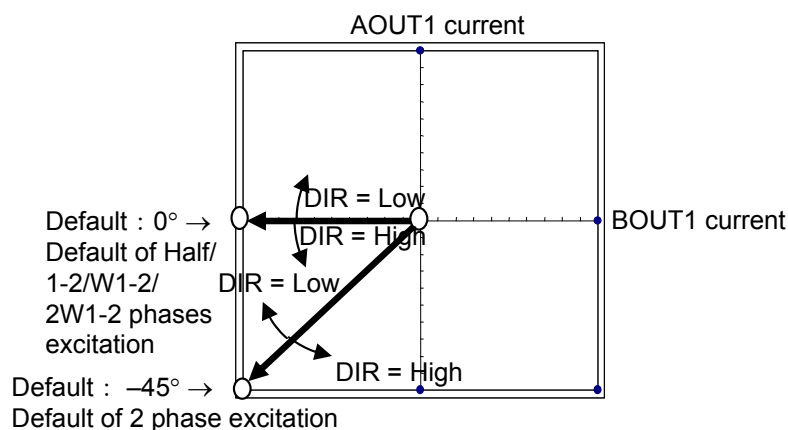

9) PHA input signal and DIR input signal

The set/hold time of PHA and DIR input signals, PHA input minimum pulse width (High/Low) are shown as the below figure.

Input signals after securing set/hold time.

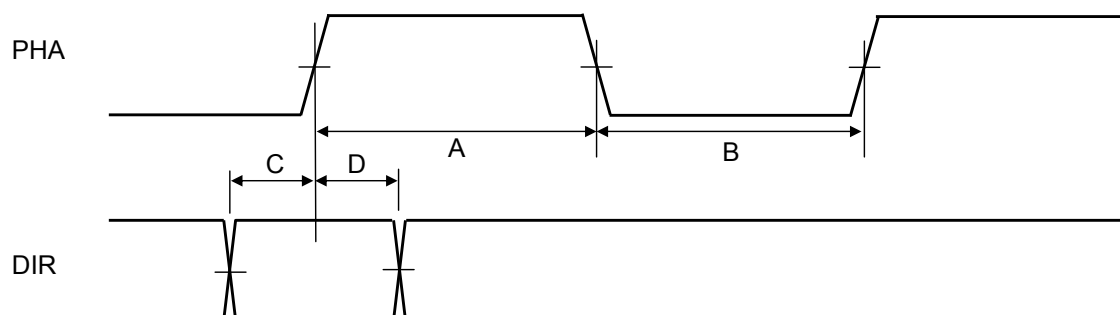

Period	Contents	Time
A	PHA input minimum pulse width (High)	5 μs or more
B	PHA input minimum pulse width (Low)	5 μs or more
C	DIR set time	2 μs or more
D	DIR hold time	2 μs or more

APPLICATIONS INFORMATION (continued)

1.Notes (continued)

10) PHA input at ENABLE = High

As the below figure (Ex. 1-2 phase excitation), when inputting PHA at the time of motor stop and ENABLE = High (All phases are OFF → Motor current = 0 A), the setup value of motor current will proceed at PHA input. Therefore, in case of restart at ENABLE = Low, take notice that the position of restart is where the current state just before motor stop gains PHA input.

Ex.) 1-2 phase excitation

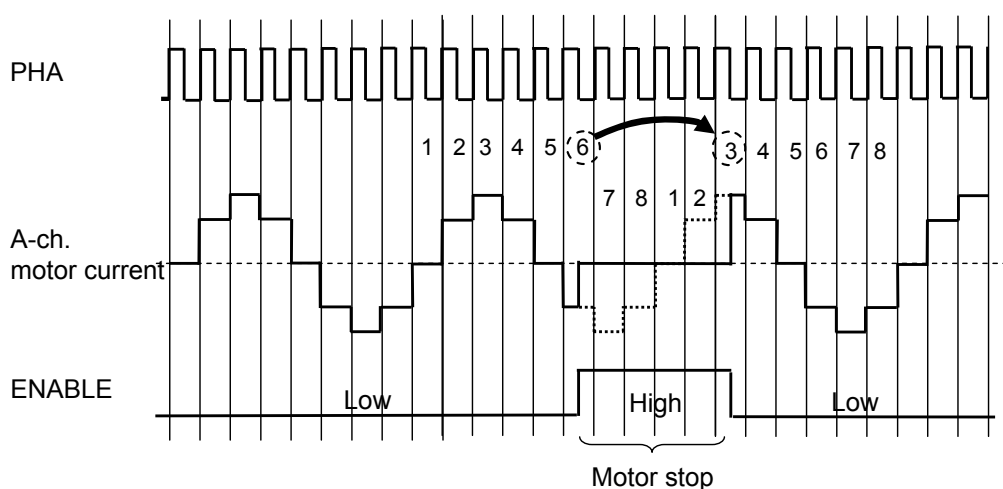

In spite of stop at state[6] , because PHA is input at ENABLE = High, the motor will restart after ENABLE = Low at state [3].

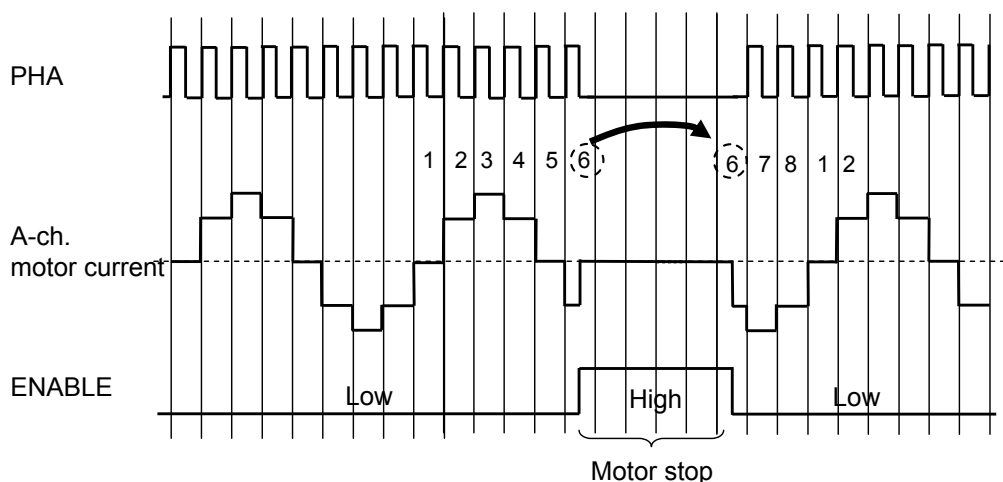

In spite of stop at state [6] , because PHA is not input at ENABLE = High, the motor will restart after ENABLE = Low at state [6] just before stop.

APPLICATIONS INFORMATION (continued)

1. Notes (continued)

11) Notes on RCS line

Take consideration in the below figure and the points and design PCB pattern.

(1) Point 1

Design so that the wiring to the current detection pin (RCSA/RCSB pin) of this LSI is thick and short to lower impedance. This is why current can not be detected correctly owing to wiring impedance and current might not be supplied to a motor sufficiently.

(2) Point 2

Design so that the wiring between current detection resistor and connector GND (the below figure Point 2) is thick and short to lower impedance. As the same as Point 1, sufficient current might not be supplied due to wiring impedance. In addition, if there is a common impedance on the side of GND of RASA and RCSB, peak detection might be erroneous detection. Therefore, install the wiring on the side of GND of RCSA and RCSB independently.

(3) Point 3

Connect GND pin of this LSI to the connector on PCB independently. Separate the wiring removed current detection resistor of large current line (Point 2) from GND wiring and make these wirings one-point shorted at the connector as the below figure. That can make fluctuation of GND minimum.

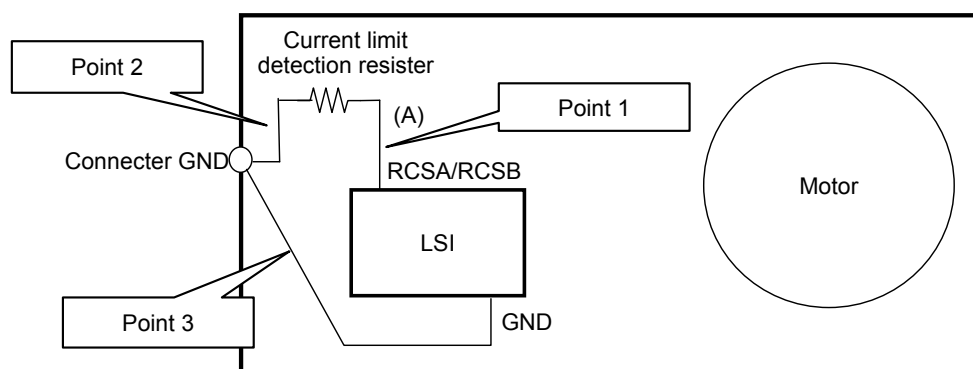

12) A high current flows into the LSI. Therefore, the common impedance of PCB can not be ignored. Take the following points into consideration and design the PCB pattern for a motor. Because the wiring connecting to VM1 (Pin 17) and VM2 (Pin 1) of this LSI is high-current, it is easy to generate noise at time of switching by wiring L. That might cause malfunction and destruction (Figure 2). As Figure 3, the escape way of the noise is secured by connecting a capacitor to the connector close to the VM pin of the LSI. This makes it possible to suppress the fluctuation of direct VM pin voltage of the LSI. Make the setting as shown in Figure 3 as much as possible.

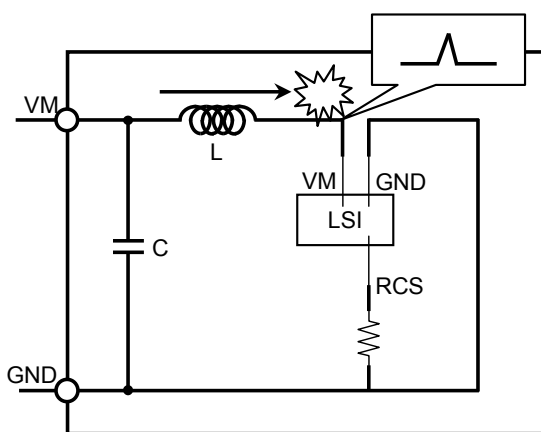

Figure 2. No recommended pattern

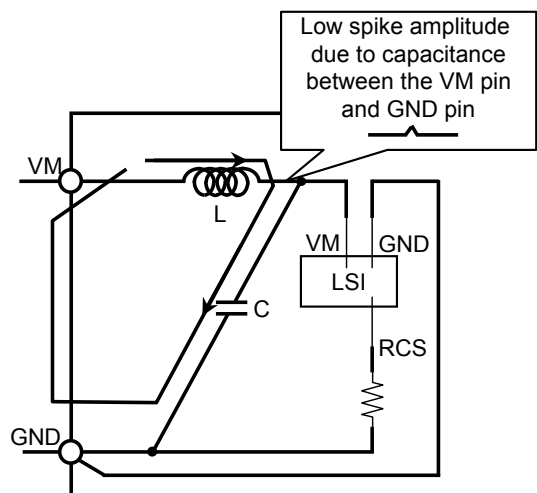

Figure 3. Recommended pattern

APPLICATIONS INFORMATION (continued)

1. Notes (continued)

13) LSI junction temperature

In case of measuring chip temperature of this LSI, measure the voltage of TJMON pin (Pin 3) and estimate the chip temperature from the data below. However, because this data is technical reference data, conduct a sufficient reliability test of the LSI and evaluate the product with the LSI incorporated.

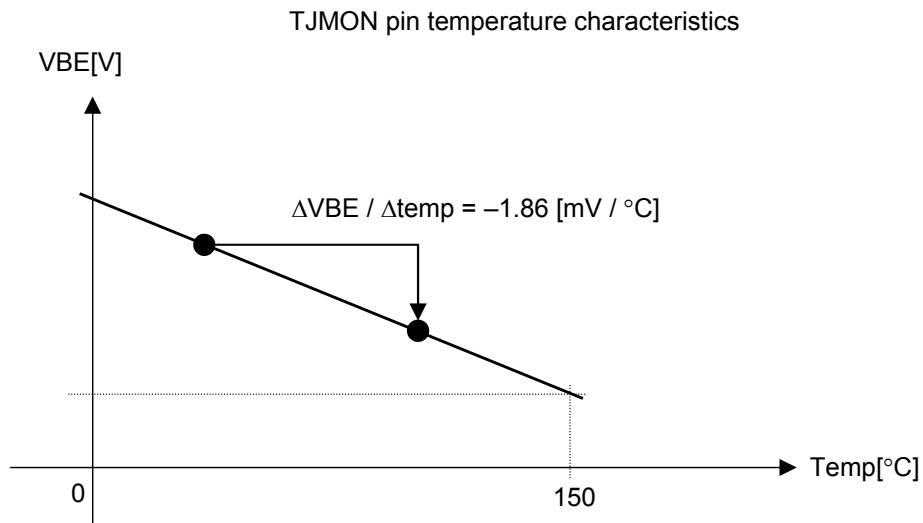

14) Speed of supply and cut of power

When supplying to VM pin (Pin 1, 17) , set the rise speed of VM voltage to less than 0.1 V/ μ s and fall speed to less than 0.1 V/ μ s. If the speed of rise and fall of power supply is too rapid, that might cause malfunction and destruction of the LSI. In this case, conduct a sufficient reliability test and also check a sufficient evaluation for a product.

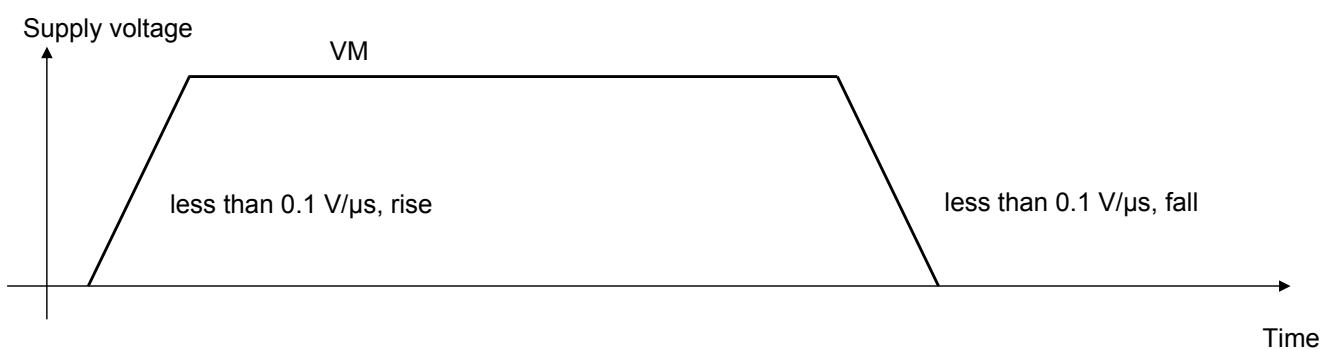

PACKAGE INFORMATION (Reference Data)

Package Code:HSOP034-P-0300A

unit:mm

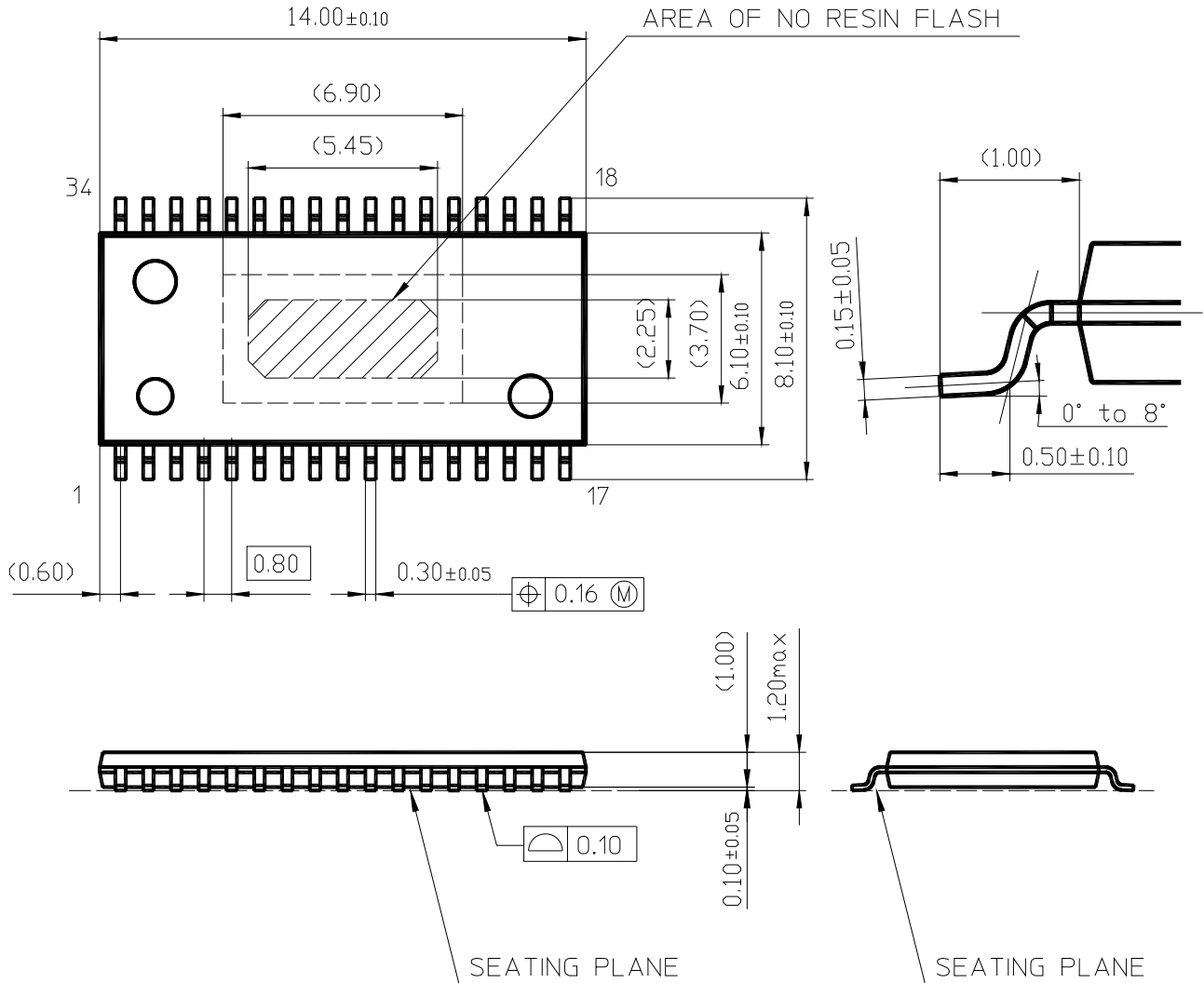

Body Material	: Epoxy Resin
Lead Material	: Cu Alloy
Lead Finish Method	: Pd Plating

IMPORTANT NOTICE

1. The products and product specifications described in this book are subject to change without notice for modification and/or improvement. At the final stage of your design, purchasing, or use of the products, therefore, ask for the most up-to-date Product Standards in advance to make sure that the latest specifications satisfy your requirements.
2. When using the LSI for new models, verify the safety including the long-term reliability for each product.
3. When the application system is designed by using this LSI, be sure to confirm notes in this book. Be sure to read the notes to descriptions and the usage notes in the book.
4. The technical information described in this book is intended only to show the main characteristics and application circuit examples of the products. No license is granted in and to any intellectual property right or other right owned by Panasonic Corporation or any other company. Therefore, no responsibility is assumed by our company as to the infringement upon any such right owned by any other company which may arise as a result of the use of technical information de-scribed in this book.
5. This book may be not reprinted or reproduced whether wholly or partially, without the prior written permission of our company.
6. This LSI is intended to be used for general electronic equipment.
Consult our sales staff in advance for information on the following applications: Special applications in which exceptional quality and reliability are required, or if the failure or malfunction of this LSI may directly jeopardize life or harm the human body.
Any applications other than the standard applications intended.
 - (1) Space appliance (such as artificial satellite, and rocket)
 - (2) Traffic control equipment (such as for automobile, airplane, train, and ship)
 - (3) Medical equipment for life support
 - (4) Submarine transponder
 - (5) Control equipment for power plant
 - (6) Disaster prevention and security device
 - (7) Weapon
 - (8) Others : Applications of which reliability equivalent to (1) to (7) is requiredIt is to be understood that our company shall not be held responsible for any damage incurred as a result of or in connection with your using the LSI described in this book for any special application, unless our company agrees to your using the LSI in this book for any special application.
7. This LSI is neither designed nor intended for use in automotive applications or environments unless the specific product is designated by our company as compliant with the ISO/TS 16949 requirements.
Our company shall not be held responsible for any damage incurred by you or any third party as a result of or in connection with your using the LSI in automotive application, unless our company agrees to your using the LSI in this book for such application.
8. If any of the products or technical information described in this book is to be exported or provided to non-residents, the laws and regulations of the exporting country, especially, those with regard to security export control, must be observed.
9. Please use this product in compliance with all applicable laws and regulations that regulate the inclusion or use of controlled substances, including without limitation, the EU RoHS Directive. Our company shall not be held responsible for any damage incurred as a result of your using the LSI not complying with the applicable laws and regulations.

USAGE NOTES

1. When designing your equipment, comply with the range of absolute maximum rating and the guaranteed operating conditions (operating power supply voltage and operating environment etc.). Especially, please be careful not to exceed the range of absolute maximum rating on the transient state, such as power-on, power-off and mode-switching. Otherwise, we will not be liable for any defect which may arise later in your equipment.

Even when the products are used within the guaranteed values, take into the consideration of incidence of break down and failure mode, possible to occur to semiconductor products. Measures on the systems such as redundant design, arresting the spread of fire or preventing glitch are recommended in order to prevent physical injury, fire, social damages, for example, by using the products.

2. Comply with the instructions for use in order to prevent breakdown and characteristics change due to external factors (ESD, EOS, thermal stress and mechanical stress) at the time of handling, mounting or at customer's process. When using products for which damp-proof packing is required, satisfy the conditions, such as shelf life and the elapsed time since first opening the packages.
3. Pay attention to the direction of LSI. When mounting it in the wrong direction onto the PCB (printed-circuit-board), it might smoke or ignite.
4. Pay attention in the PCB (printed-circuit-board) pattern layout in order to prevent damage due to short circuit between pins. In addition, refer to the Pin Description for the pin configuration.
5. Perform a visual inspection on the PCB before applying power, otherwise damage might happen due to problems such as a solder-bridge between the pins of the semiconductor device. Also, perform a full technical verification on the assembly quality, because the same damage possibly can happen due to conductive substances, such as solder ball, that adhere to the LSI during transportation.
6. Take notice in the use of this product that it might break or occasionally smoke when an abnormal state occurs such as output pin-VM short (Power supply fault), output pin-GND short (Ground fault), or output-to-output-pin short (load short).

Especially, for the pins below, take notice Power supply fault, Ground fault, load short and short between the pin below and current detection pin.

- (1) AOUT1(Pin 12), AOUT2(Pin 10), BOUT1(Pin 8), BOUT2(Pin 6)
- (2) BC1(Pin 13), BC2(Pin 14), VPUMP(Pin 15)
- (3) VM1(Pin 17), VM2(Pin 1), S5VOUT(Pin 24)
- (4) RCSA(Pin 11), RCSB(Pin 7)

And, safety measures such as an installation of fuses are recommended because the extent of the above-mentioned damage and smoke emission will depend on the current capability of the power supply.

7. The protection circuit is for maintaining safety against abnormal operation. Therefore, the protection circuit should not work during normal operation.

Especially for the thermal protection circuit, if the area of safe operation or the absolute maximum rating is momentarily exceeded due to output pin to VCC short (Power supply fault), or output pin to GND short (Ground fault), the LSI might be damaged before the thermal protection circuit could operate.
8. Unless specified in the product specifications, make sure that negative voltage or excessive voltage are not applied to the pins because the device might be damaged, which could happen due to negative voltage or excessive voltage generated during the ON and OFF timing when the inductive load of a motor coil or actuator coils of optical pick-up is being driven.
9. The product which has specified ASO (Area of Safe Operation) should be operated in ASO.
10. Verify the risks which might be caused by the malfunctions of external components.

USAGE NOTES (continued)

11. Connect the metallic plate (fin) on the back side of the LSI with the GND potential. The thermal resistance and the electrical characteristics are guaranteed only when the metallic plate (fin) is connected with the GND potential.
12. Confirm characteristics fully when using the LSI.
Secure adequate margin after considering variation of external part and this LSI including not only static characteristics but transient characteristics. Especially, Pay attention that abnormal current or voltage must not be applied to external parts because the pins (Pin 6, 8, 10, 12, 13, 14, 15) output high current or voltage.
13. Design the heat radiation with sufficient margin so that Power dissipation must not be exceeded base on the conditions of power supply voltage, load and ambient temperature.
(It is recommended to design to set connective parts to 70% to 80% of maximum rating)
14. Set capacitance value between VPUMP and GND so that VPUMP (Pin 15) must not exceed 43 V transiently at the time of motor standby to motor start.
15. This LSI employs a PWM drive method that switches the high-current output of the output transistor. Therefore, the LSI is apt to generate noise that may cause the LSI to malfunction or have fatal damage. To prevent these problems, the power supply must be stable enough. Therefore, the capacitance between the S5VOUT and GND pins must be a minimum of 0.1 μ F and the one between the VM and GND pins must be a minimum of 47 μ F and as close as possible to the LSI so that PWM noise will not cause the LSI to malfunction or have fatal damage.

Request for your special attention and precautions in using the technical information and semiconductors described in this book

- (1) If any of the products or technical information described in this book is to be exported or provided to non-residents, the laws and regulations of the exporting country, especially, those with regard to security export control, must be observed.
- (2) The technical information described in this book is intended only to show the main characteristics and application circuit examples of the products. No license is granted in and to any intellectual property right or other right owned by Panasonic Corporation or any other company. Therefore, no responsibility is assumed by our company as to the infringement upon any such right owned by any other company which may arise as a result of the use of technical information de-scribed in this book.
- (3) The products described in this book are intended to be used for general applications (such as office equipment, communications equipment, measuring instruments and household appliances), or for specific applications as expressly stated in this book.
Please consult with our sales staff in advance for information on the following applications, moreover please exchange documents separately on terms of use etc.: Special applications (such as for in-vehicle equipment, airplanes, aerospace, automotive equipment, traffic signaling equipment, combustion equipment, medical equipment and safety devices) in which exceptional quality and reliability are required, or if the failure or malfunction of the products may directly jeopardize life or harm the human body.
Unless exchanging documents on terms of use etc. in advance, it is to be understood that our company shall not be held responsible for any damage incurred as a result of or in connection with your using the products described in this book for any special application.
- (4) The products and product specifications described in this book are subject to change without notice for modification and/or improvement. At the final stage of your design, purchasing, or use of the products, therefore, ask for the most up-to-date Product Standards in advance to make sure that the latest specifications satisfy your requirements.
- (5) When designing your equipment, comply with the range of absolute maximum rating and the guaranteed operating conditions (operating power supply voltage and operating environment etc.). Especially, please be careful not to exceed the range of absolute maximum rating on the transient state, such as power-on, power-off and mode-switching. Otherwise, we will not be liable for any defect which may arise later in your equipment.
Even when the products are used within the guaranteed values, take into the consideration of incidence of break down and failure mode, possible to occur to semiconductor products. Measures on the systems such as redundant design, arresting the spread of fire or preventing glitch are recommended in order to prevent physical injury, fire, social damages, for example, by using the products.
- (6) Comply with the instructions for use in order to prevent breakdown and characteristics change due to external factors (ESD, EOS, thermal stress and mechanical stress) at the time of handling, mounting or at customer's process. We do not guarantee quality for disassembled products or the product re-mounted after removing from the mounting board.
When using products for which damp-proof packing is required, satisfy the conditions, such as shelf life and the elapsed time since first opening the packages.
- (7) When reselling products described in this book to other companies without our permission and receiving any claim of request from the resale destination, please understand that customers will bear the burden.
- (8) This book may be not reprinted or reproduced whether wholly or partially, without the prior written permission of our company.