

# Infrared Array Sensor & Pressure Sensors

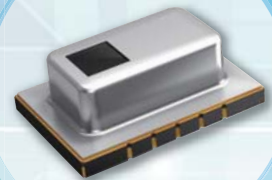

**Guidelines and precautions regarding the technical information and use of our products described in this online catalog.**

- If you want to use our products described in this online catalog for applications requiring special qualities or reliability, or for applications where the failure or malfunction of the products may directly jeopardize human life or potentially cause personal injury (e.g. aircraft and aerospace equipment, traffic and transportation equipment, combustion equipment, medical equipment, accident prevention, anti-crime equipment, and/or safety equipment), it is necessary to verify whether the specifications of our products fit to such applications. Please ensure that you will ask and check with our inquiry desk as to whether the specifications of our products fit to such applications use before you use our products.
- The quality and performance of our products as described in this online catalog only apply to our products when used in isolation. Therefore, please ensure you evaluate and verify our products under the specific circumstances in which our products are assembled in your own products and in which our products will actually be used.
- If you use our products in equipment that requires a high degree of reliability, regardless of the application, it is recommended that you set up protection circuits and redundancy circuits in order to ensure safety of your equipment.
- The products and product specifications described in this online catalog are subject to change for improvement without prior notice. Therefore, please be sure to request and confirm the latest product specifications which explain the specifications of our products in detail, before you finalize the design of your applications, purchase, or use our products.
- The technical information in this online catalog provides examples of our products' typical operations and application circuits. We do not guarantee the non-infringement of third party's intellectual property rights and we do not grant any license, right, or interest in our intellectual property.
- If any of our products, product specifications and/or technical information in this online catalog is to be exported or provided to non-residents, the laws and regulations of the exporting country, especially with regard to security and export control, shall be observed.

**<Regarding the Certificate of Compliance with the EU RoHS Directive/REACH Regulations>**

- The switchover date for compliance with the RoHS Directive/REACH Regulations varies depending on the part number or series of our products.
- When you use the inventory of our products for which it is unclear whether those products are compliant with the RoHS Directive/REACH Regulation, please select "Sales Inquiry" in the website inquiry form and contact us.

**We do not take any responsibility for the use of our products outside the scope of the specifications, descriptions, guidelines and precautions described in this online catalog.**

## Safety precautions

- Do not use these sensors under any circumstances in which the range of their ratings, environment conditions or other specifications are exceeded. Using the sensors in any way which causes their specifications to be exceeded may generate abnormally high levels of heat, emit smoke, etc., resulting in damage to the circuitry and possibly causing an accident.
- Before connecting a connector, check the pin layout by referring to the connector wiring diagram, specifications diagram, etc., and make sure that the connector is connected properly. Take note that mistakes made in connection may cause unforeseen problems in operation, generate abnormally high levels of heat, emit smoke, etc., resulting in damage to the circuitry.
- Do not use any motion sensor which has been disassembled or remodeled.
- Protection circuit recommended.  
The possible failure mode is either open or short of the output transistor. An excess heat is the cause for short mode failure. For any important and serious application in terms of safety, add protection circuit or any other protection method.
  - Various safety equipment and safety equipment
  - Traffic light
  - Security crime prevention equipment
  - Equipment concerning control and safety of trains, cars, etc.
  - Applications such as temperature control using sensor output etc. (Grid-EYE)
- If it is expected that malfunction of each sensor may cause injury to persons or serious expansion damage, be sure to implement safety measures such as double safety circuit.

## Request for ordering and use

The products and specifications listed in this document are subject to change for product improvement, etc. (including specification changes and discontinued manufacturing). When examining mass-production design or placing an order for the listed products, please contact Panasonic to make sure that the information listed in this document is up-to-date.

- If it is expected that malfunction of each sensor may cause injury to persons or serious expansion damage, be sure to implement safety measures.
  - Reference Standards** : Computers, office automation equipment, communications equipment, audio-video products, home electrical appliances, machine tools, personal devices, industrial robots.
  - Special Standards** : Transportation equipment (automobiles, trains, ships, etc.), traffic signal equipment, crime and disaster prevention devices, electric power equipment, various safety devices, and medical equipment not directly targeted for life support.
  - Specified Standards** : Aircraft equipment, aeronautical and space equipment, seabed relay equipment, nuclear power control systems, and medical equipment, devices and systems for life support.
- Before considering the use of our products under the following conditions, you must contact one of our customer service representatives without fail and exchange written specifications.
  - When our products are to be used in any of the applications listed for the Special Standards or Specified Standards.
  - When, even for any of the applications listed for the Reference Standards, our products may possibly be used beyond the range of the specifications, environment or conditions listed in the document or when you are considering the use of our products in any conditions or an environment that is not listed in the document.

### [Acceptance Inspection]

For a purchased or delivered product, please conduct an acceptance inspection promptly with adequate consideration given to the management and maintenance of the product before and during the acceptance inspection.

### [Warranty Period]

The warranty period of these products is one year after the purchase or delivery to a location designated by your company, unless otherwise specified by both parties.

### [Scope of Warranty]

If a failure or a defect attributable to Panasonic is found during the warranty period, we will promptly provide a replacement or a necessary replacement part or change/repair the defective part free of charge at the location of the purchase or delivery.

The warranty does not cover a failure or a defect when any of the following applies :

- (1) Caused by specifications, standards, or handling methods, etc. designated by your company.
- (2) Caused by modification of the structure, capabilities, or specifications, etc., in which Panasonic is not engaged, carried out after the purchase or delivery.
- (3) Caused by an unforeseen phenomenon that cannot be predicted with the technologies available after the time of the purchase or at the time of concluding the agreement.
- (4) When the product was used outside the scope of the conditions/environments described in the catalog or specifications.
- (5) When the product is incorporated in your company's equipment for use, damages that could be avoided if your company's equipment had industry-standard functions, structures, etc.
- (6) Caused by natural disasters or Force Majeure.

The warranty described here is limited to the purchased or delivered product only and does not cover any consequential damages arising from the failure or defect of the product.

### [Before Purchase]

- The standard prices of the products listed in this catalog do not include consumption tax, delivery, installation & adjustment fees, used product collection fees, etc.
- The specifications/appearance are subject to change without notice for product improvement.
- The export of products that fall into the category of strategic goods (or services) require an export (or a service transaction) license under the Foreign Exchange and Foreign Trade Law. Please contact Panasonic for details.
- For details of the products listed in this catalog, please contact distributors, specialty contractor stores, or Panasonic.

Built-in sensor contributes to energy savings, safety, and comfort.

Providing sensors for various aspects of our lives.

**Microwave oven**

Grid-EYE (Temperature measurement)

**Air conditioner**

Grid-EYE (Human detection)

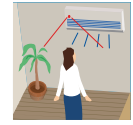

**ON/OFF of door light**

Grid-EYE (Human detection)



Light turns off when surroundings are bright.



Dim lighting when it gets dark.



100% when Grid-EYE detects a person nearby.



Returns to dim lighting when person is gone.

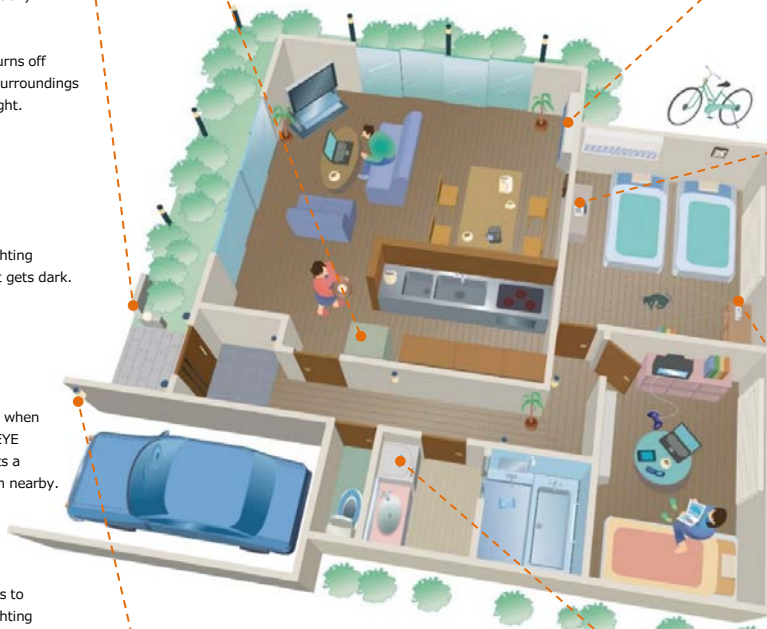

**Sphygmomanometer**

Pressure Sensor (Pressure detection)

**Security camera**

Grid-EYE (Human detection)

**ON/OFF of garage light**

Grid-EYE (Human detection)

**Water level detection for washing machine**

PS-A Pressure Sensor (Low pressure type)

**Air bed**

Pressure Sensor (Pressure detection)

**Automatic**

Grid-EYE (Human detection)

**Sphygmomanometer**

Pressure Sensor (Pressure detection)

**Automatic lighting in conference room**

Grid-EYE (Human detection)

**Security for parking lot**

Grid-EYE (Human detection)



Color mode screen in the day.

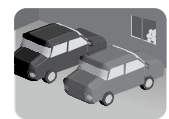

Screen switches to night vision mode when it gets dark.

**ON/OFF of lighting**

Grid-EYE (Human detection)

**Motion detection for instant photography machine**

Grid-EYE (Human detection)

# Human Heat

## Infrared Array

High Precision Infrared Array Sensor based on Advanced MEMS

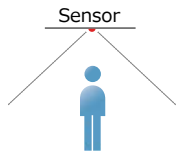







Product name	Detection method	Type		Characteristics
Thermopile type	Detecting the heat (infrared rays) of the human body and other objects. 	Operating voltage 3.3 V 5.0 V	Amplification factor High gain Low gain	<ul style="list-style-type: none"> <li>● Temperature detection achieved on a two dimensional area with 8 × 8 (64) pixels.</li> <li>● Digital output</li> <li>● Miniature SMD package</li> </ul>
<b>Grid-EYE</b>				



# Pressure

## Pressure Sensors

A wide range of rated pressure, including minute pressures

Product name	Pressure medium	Type(*Without glass base type)		Terminal direction	Pressure inlet hole length	Characteristics
<b>PS-A Pressure Sensor</b> 	Air	Rated pressure		Opposite the pressure inlet direction 	3 mm  5 mm 	<ul style="list-style-type: none"> <li>● Compact pressure sensor with built-in amplification and temperature compensation circuit</li> </ul>
		<Low pressure type> 6 kPa			5 mm Φ3 mm  13.5 mm Φ5.45 mm 	
<b>PS/PF Pressure Sensor</b> 	Air	Rated pressure	Bridge resistanc	Opposite the pressure inlet direction  (SMD terminal)	-	<ul style="list-style-type: none"> <li>● Ultra-miniature base area 7.2 (W) x 7.2 (D) mm 0.283 (W) x 0.283 (D) inch</li> <li>● A wide range of rated pressure, including a minute pressure.</li> </ul>
		4.9, 34.3, 49.0, 98.1, 196.1, 343.2, 490.3, 833.6, 980.7 k Pa	5 kΩ			

# *Infrared Array Sensor Grid-EYE*

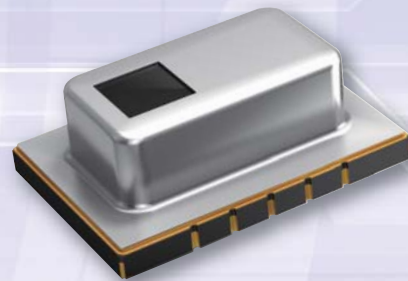

## Safety Precautions

### ■ Head the following precautions to prevent injury or accidents.

- (1) We take no responsibility for troubles caused by the product usage that is not specified in this specification.  
Using the sensors in any way which causes their specifications to be exceeded may generate abnormally high levels of heat, emit smoke, etc., resulting in damage to the circuitry and possibly causing an accident.
- (2) Before connecting a connector, check the pin layout by referring to the connector wiring diagram, specifications diagram, etc., and make sure that the connector is connected properly. Take note that mistakes made in connection may cause unforeseen problems in operation, generate abnormally high levels of heat, emit smoke, etc., resulting in damage to the circuitry.
- (3) If the module heats up abnormally or smells abnormal, stop using it immediately by turning off the main power supply of the device etc.
- (4) The fact remains that electrical components and devices generally cause failures at probability. Furthermore, their durability varies with use environments or use conditions. In this respect, we ask you to check for actual electrical components and devices under actual conditions before use without fail.
- (5) Failure modes of sensors include short-circuiting, open-circuiting and temperature rises. If the failure of the product is considered to cause a personal injury or death or property damage, the safety rate should be added to the specified values shown in this specifications and please consider the fail-safe design in the following considerations and ensure safety.
  - Provide protection circuits and protection devices to ensure system safety.
  - Provide of a redundant circuit so that a malfunction does not make the system unsafety.
- (6) When a dogma shall be occurred about safety for this product, be sure to inform us rapidly, operate your technical examination.

## Notes

### ■ Precaution for fundamental structure of sensor

Infrared Array Sensor is a thermopile type infrared sensor which detects the amount of infrared rays. Below conditions generally degrade the temperature accuracy.

Carefully check the performance and stability under actual use conditions, and perform temperature corrections when necessary.

- (1) When heating elements exist near the mounting position of the sensor.
- (2) When the sensor is exposed to cold or hot air.
- (3) When the temperature of the sensor body rapidly changes.
- (4) When substances (e.g., glasses, acrylics or steams), which hardly transmit a far infrared ray, exist between the sensor and the detected object.
- (5) When substances (e.g., foreign substances or water), which hardly transmit a far infrared ray, adhere to the lense of the sensor.

### ■ Use environment

- (1) Temperature: See the specifications
- (2) Humidity: 15 % to 85 % R.H. (Avoid freezing and dew condensation)
- (3) Atmospheric pressure: 86 to 106 kPa
- (4) Vibrations and shocks may damage the sensor, and cause malfunction and performance deterioration. If loads and shocks are applied on the lense, the damaged sensor may cause malfunction and performance deterioration.
- (5) The product is not water/splash-proof. Perform water/dust-proofing and dew condensation / freezing countermeasures in accordance with use environment. When dew condensation occurs, responsiveness of heat source detection may delay for several seconds. Be careful to solder migration caused by adhesion of water droplets on solder parts.
- (6) Avoid use and storage in the corrosive gas (organic solvent, sulfurous acid and hydrogen sulfide gases) to avoid malfunction and performance deterioration.
- (7) Use surge absorbers as applying the external surge voltage may damage the internal circuit.
- (8) Malfunction may occur near electric noises from static electricity, lightning, broadcast or amateur radio stations and mobile phones.
- (9) The sensor can continuously operate within the range of using ambient temperature (using ambient humidity). However, ensure that humidity is within the range described in the following page as humidity varies according to temperature. Avoid the continuous operation near the operational limit. The temperature range does not guarantee the durability.

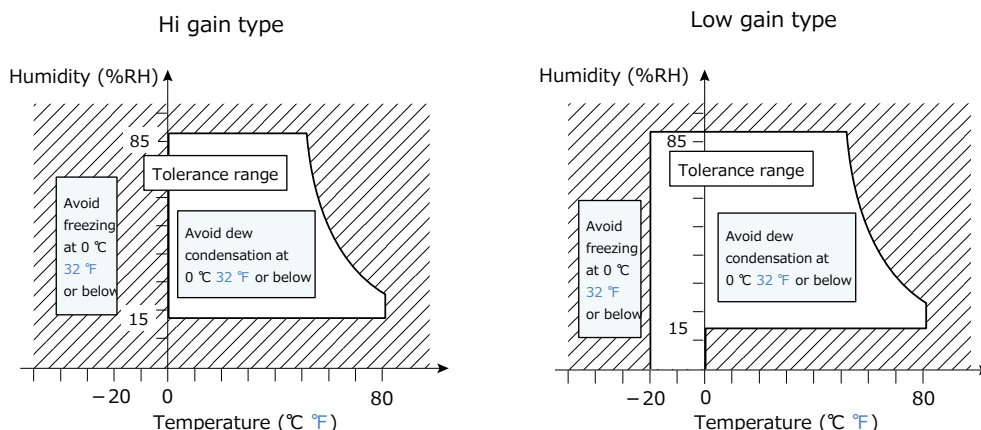

## Notes

## ■ Mounting

Use the land of the printed-circuit board on which the sensor is securely fixed. The recommended printed-circuit board is FR4 (thickness 1.6 mm 0.063 inch). When mounting on the deprecated circuit board, carefully check the performance and quality under actual use conditions before use.

- (1) A large noise on the power supply may cause malfunction. Place the recommended capacitor near the sensor (within 20 mm 0.787 inch of the wiring pattern length) between sensor input terminals (VDD-GND) to secure power superimposed noise resistance. Test with the actual machine and reselect the capacitor with optimal capacitance.
- (2) Prevent the metal part of other electronic components from contacting with the sensor body as the upper face (where part numbers are imprinted) of the sensor is GND.

## ■ Soldering

Due to the thermal capacity of the infrared array sensor is low, therefore, take steps to minimize the effects of external heat. Damage and changes to characteristics may occur due to heat deformation.

## (1) Manual soldering

Set the soldering tip from 350 to 400 °C (30 - 60 W), and solder within 3 seconds or less. Note that output may be changed if the load is applied to the terminals when the soldering carefully clean the tip of soldering iron.

## (2) Reflow soldering

## • Solder coating

We recommend the screen solder printing method as the method of cream. Halogen type (Chlorine type, Bromine type, etc.) or other high-activity flux is not recommended as the residue may affect performance or reliability of resistors.

## • Mounting of sensor

Self alignment may not always work as expected, therefore, be carefully the position of the terminals and pattern.

## • The recommended reflow temperature profile

The recommended reflow temperature profile conditions are given below. The temperature of the profile is assumed to be a value measured with the printed wiring board of the product terminal neighborhood. The temperature of PCB near this product terminal at the time of mounting changes depending on PCB design. Therefore, please confirm the temperature of PCB near this product terminal to become the specified temperature profile when this product be mounted on the PCB.

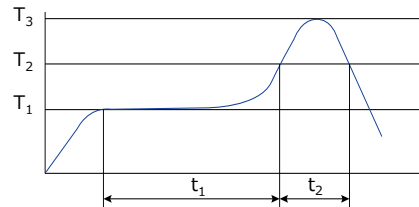

$T_1 = 150 \text{ to } 180 \text{ } ^\circ\text{C}$  302 °F to 356 °F

$T_2 = 230 \text{ } ^\circ\text{C}$  446 °F

$T_3 = \text{Below } 250 \text{ } ^\circ\text{C}$  482 °F

$t_1 = 60 \text{ to } 120 \text{ s}$

## (3) Solder reworking

Finish reworking in one operation for reworking of the solder bridge, use a soldering iron with a flat tip do not add more flux when reworking Refer the conditions of manual soldering to rework.

## (4) Coating of PCB

To prevent the insulation of the PC board after soldering, not to place the chemicals on lens of the sensor when coating.

## (5) Dividing of PCB

When you cut, fold, or fix with screw the PCB after mounting the sensor, not to stress to the sensor and the soldered parts.

## (6) Structure of sensor terminals

The sensor terminals are designed to be exposed, so contact of the terminals with metal shards and the like will cause output errors. Therefore, be careful not to touch the terminals with the metal piece or the hand.

## (7) Both-side soldering

When you do the reflow solder to the back of the PC board after the reflow of the sensor, execute fixed processing, or instance, with the adhesive etc.

## (8) When handling this product, do not touch it with bare hands. Please wear gloves.

## ■ Wire connection

Correctly wire as in the connection diagram. Reverse connection may damage the product and degrade the performance.

Do not use empty terminals. Such use may damage the sensor. For cable wiring, use shield wires with possibly short wiring lengths to prevent the influence of the noise.

## ■ Cleaning

If the dirt or water droplets is attached to the lens, wipe it with soft cloth. The lens is damaged when strongly rubbed, and causes the characteristic deterioration. Avoid ultrasonic cleaning since this may cause breaks or disconnections in the wiring.

## ■ Transportation and storage

(1) Extreme vibration and shock during transport will damage the sensor. Handle the outer box and reel with care.

(2) Storage under extreme conditions will cause soldering degradation, external appearance defects, and characteristic deterioration.

The following storage conditions are recommended.

Temperature : 0 °C to 45 °C 32 °F to 113 °F

Humidity : 70 %RH

Others : Not storage in places full of corrosive gases such as sea breeze, Cl<sub>2</sub>, H<sub>2</sub>S, NH<sub>3</sub>, SO<sub>2</sub>, and NO<sub>x</sub>, minimal dust.

Not storage in places exposed to direct sunlight.



## Notes

- (3) The sensors are sensitive to moisture and come in moisture-proof packages.  
Observe the following cautions when storing.
  - After the moisture-proof package is unsealed, take the sensors out of storage as soon as possible (within 1 week, less than 30 °C, less than 60 %R.H.)
  - If the sensors are to be left in storage for a considerable period after the moisture-proof package has been unsealed, keep them in another moisture-proof bag containing silica gel (within 3 months at the most).
- (4) When using the product stored for a long time, dry the package before reflow work.
  - When mounting with solder, if thermal stress is applied to sensors that have absorbed moisture, the moisture will vaporize, swelling will occur, and the inside of the package will become stressed. This may cause the package surface to blister or crack. Therefore, take caution and observe the soldering conditions.

### ■ Other handling cautions

- (1) To assure reliability, check the sensor under actual loading conditions. Avoid any situation that may adversely affect its performance.
- (2) This product may malfunction if dropped on its own before it is installed. Do not use if this happens.
- (3) If the sensor get high frequency vibration, it can be cause of breakdown. When the product get impulse like below, do not use it.
  - Touch to a object made of metal
  - Touch of mutual sensors
- (4) Since static charge can damage the sensor, bear in mind the following handling precautions.
  - Plastic containers should not be used to store or transport the sensors since they readily become charged.
  - Store or transport the product in an environment that hinders the occurrence of static electricity (for example, places with 45 % to 60 % humidity) and protect the product using electrically conductive packaging.
  - Implement static electricity prevention measures once the product packaging has been opened.
- (5) Do not use this product which has been disassembled or remodeled.
- (6) Do not reuse this product after removal from the mounting board.

### ■ Special remarks

Although the best attention will be paid for the quality controls of the products, consider the followings contents.

- (1) This product is designed to use in general applications at general electric equipment (Household electric appliances, AV products, office equipment, information and equipment, etc.). This product is not an important safety product. This product is not equipped with fail proof/fault diagnosis functions. If there is possibilities to occur failure or malfunction of this product which may cause unsafe event such as (a)~(d) and damage to personnel's life, body and property, we will be not responsible for any loss or damage caused by the use of products.
  - (a) Fire accident (Fire, smoke)
  - (b) Electrocutation (Electric shock)
  - (c) Damages (Fall down/Explosion/Poisoning)
  - (d) Fire/electrocutation/damages at life end
- (2) This specification shows the quality and performance of a unit component. Before adoption, be sure to evaluate and verify the product mounting it in your product.
- (3) Unless otherwise stipulated by both parties, the warranty period of our products is one year after their purchase by you or after their delivery to the location specified by you.
- (4) In the event that we are found to blame for any failures or defects in our products during the warranty period, we will provide replacements or supply the necessary spare parts or replace and/or repair the defective sections free of charge and with all due speed at the location where the products concerned were purchased or delivered. However, the following failures and defects are not covered by the warranty:
  - When the failure or defect was caused by a specification, standard, handling method, etc. which was specified by you.
  - When the failure or defect was caused after purchase by you or delivery to your premises by an alteration in construction, performance, specification, etc. which did not involve us.
  - The case that the product condition changed by handling, storage and / or transportation after delivery.
  - When the failure or defect was caused by a phenomenon that could not be predicted by the technology that was being applied in practice either after purchase by you or at the time when the contract was signed.
  - When the use of our products deviated from the scope of the conditions and environment set forth in the specifications.
  - When, after our products were incorporated into your products or equipment for use, damage resulted which could have been avoided if your products or equipment had been equipped with the functions, construction, etc. the provision of which is accepted practice in the industry.
  - When the failure or defect was caused by a natural disaster or other force majeure. The terms and conditions of the warranty here set forth apply solely to the warranty of the discrete products which were purchased by you or delivered to your premises, and they do not cover any damage induced by their failure or defects.
- (5) The products and specifications described in this document are subject to change (including specification changes and production suspension) due to product improvements. When considering a using a new products, please contact our sales office to confirm that the information in this specifications is up-to-date.
- (6) In connection with the products you have purchased from us or with the products delivered to your premises, we ask that you perform an acceptance inspection with all due speed and, in connection with the handling of our products both before and during the acceptance inspection, we ask that you give full consideration to the control and preservation of our products.
- (7) As to the disposal of the product, check the method of disposal in each country or region where the product are incorporated in your products to be used.
- (8) The technical information in this specification provides examples of our products' typical operations and application circuits. We do not guarantee the non-infringement of third party's intellectual property rights and we do not grant any license, right, or interest in our intellectual property.

## Infrared Array Sensor Grid-EYE



**High Precision Infrared Array Sensor based on Advanced MEMS Technology**

### Feature

- Temperature detection of two-dimensional area: 8 × 8 (64 pixels)
- Digital output (capability of temperature value output)
- Compact SMD package (adaptively to reflow mounting)
- RoHS compliant

### Typical applications

- Home appliances (Microwaves and air-conditioners)
- Building automation (People counting, Air conditioning control)
- Home automation (People detection)
- Factory automation (Fault prevention)

### Ordering information

<b>AMG</b>	<b>8</b>	<b>8</b>				
	Vertical pixel	Horizontal pixel	Code	Applied voltage	Code	Amplification factor
	8 : 8 pixels	8 : 8 pixels	3	3.3 V	3	High gain
			5	5.0 V	4	Low gain

### Types

Tape and reel package : 1,000 pcs.

Product name	Number of pixel	Operating voltage	Amplification factor	Part number
Infrared array sensor Grid-EYE	64 (Vertical 8 × Horizontal 8 Matrix)	3.3 V	High gain	AMG8833
			Low gain	AMG8834
		5.0 V	High gain	AMG8853
			Low gain	AMG8854

### Rating

Item	Performance	
	High gain	Low gain
Applied voltage	3.3 V ± 0.3 V or 5.0 V ± 0.5 V	
Temperature range of measuring object	0 °C to 80 °C +32 °F to +176 °F	-20 °C ~ 100 °C -4 °F to +212 °F
Operating temperature range	0 °C to 80 °C +32 °F to +176 °F	-20 °C ~ 80 °C -4 °F to +176 °F
Storage temperature range	-20 °C to 80 °C -4 °F to +176 °F	-20 °C ~ 80 °C -4 °F to +176 °F

### Absolute maximum ratings

Item	Absolute maximum ratings	Terminal
Applied voltage	-0.3 V to 6.5 V	VDD
Input voltage	-0.3 V to VDD +0.3 V	SCL, SDA, AD_SELECT
Output sink current	-10 mA to 10 mA	INT, SDA
Static electricity (Human Body Model)	1 kV	All terminals
Static electricity (Machine Model)	200 V	All terminals

**Characteristics**

Item	Performance	
	High gain	Low gain
Temperature accuracy	Typical $\pm 2.5\text{ }^{\circ}\text{C}$ $\pm 4.5\text{ }^{\circ}\text{F}$	Typical $\pm 3.0\text{ }^{\circ}\text{C}$ $\pm 5.4\text{ }^{\circ}\text{F}$
NETD *1	Typical 0.05 K (in 1 fps setting *2) Typical 0.16 K (in 10 fps setting)	
Viewing angle	Typical 60 °	
Current consumption	Typical 4.5 mA (normal mode) Typical 0.2 mA (sleep mode)	
Setup time	Typical 50 ms (Time to enable communication after setup) Typical 15 s (Time to stabilize output after setup)	

\*1: It is calculated from 4 pixels of centers.

\*2: fps: frame per second

**Performance**

Item	Performance
Number of pixel	64 (Vertical 8 × Horizontal 8 Matrix)
External interface	I <sup>2</sup> C
Frame rate	Typical 1 fps or 10 fps
Operating mode*3	Normal Sleep
Output mode	Temperature output
Calculate mode	No moving average or Twice moving average
Temperature output resolution	0.25 °C 0.45 °F
Number of sensor address	2 (I <sup>2</sup> C slave address))
Thermistor output temperature range	-20 °C to 80 °C -4 °F to +176 °F
Thermistor output resolution	0.0625 °C 0.1125 °F

\*3: Normal Mode : normal operation mode; Sleep Mode: detection is off (output and data reading not possible)

**Internal circuit**

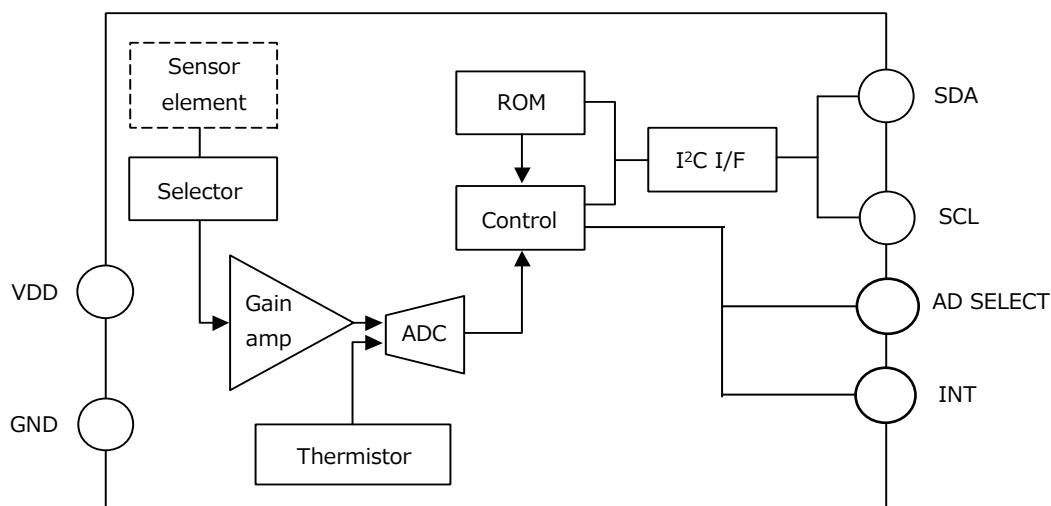

**Pixel array and viewing angle**

(1) Pixel array

Pixel array from 1 to 64 is shown below.

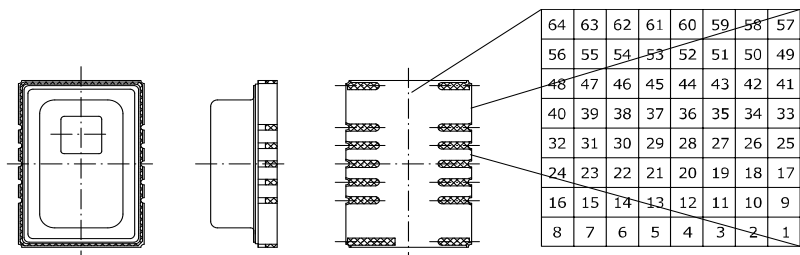

(2) Viewing angle (Typical)

Sensor viewing angle is shown below.

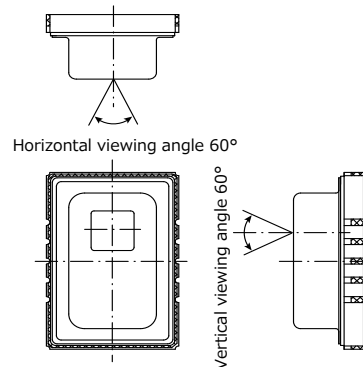

**Optical properties**

(1) Each pixel's viewing central angle (Typical) (2) Each pixel's viewing angle (Typical)

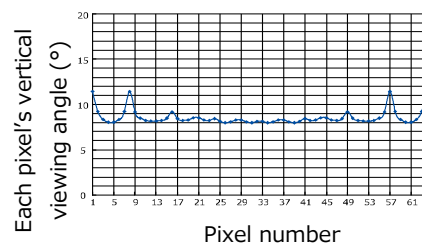
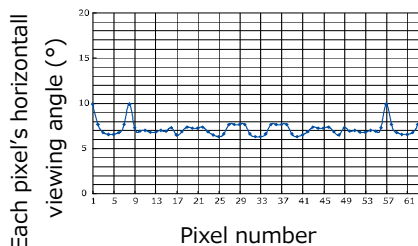
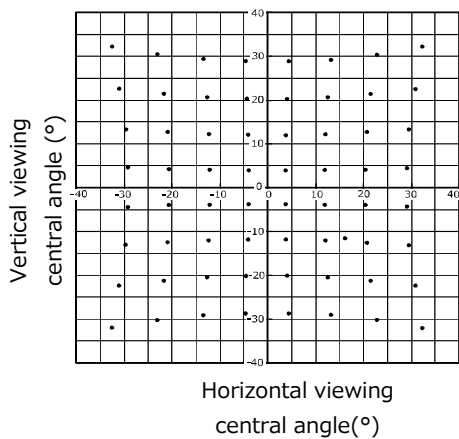

**Dimensions**

External dimensions (Typical)

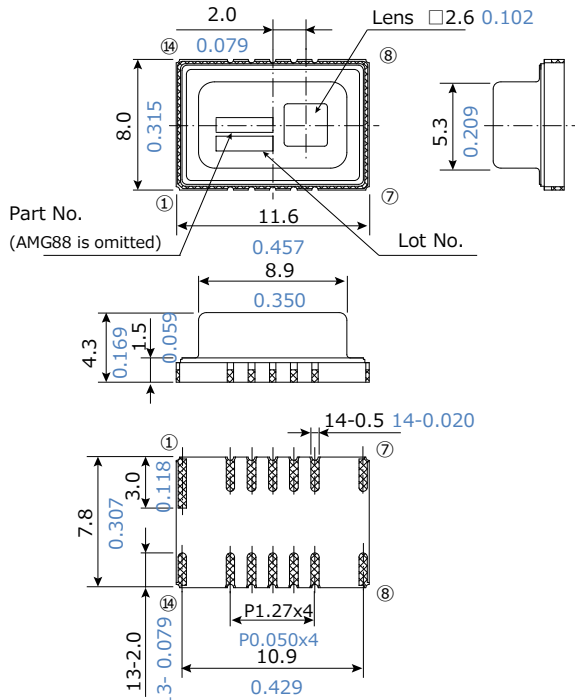

Recommended PC board pad (Typical)

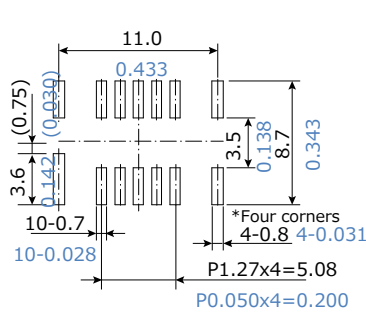

Number	Terminal name
①	NC
②	SDA
③	SCL
④	INT
⑤	AD_SELECT
⑥	GND
⑦	NC

Number	Terminal name
⑧	NC
⑨	VDD
⑩	AVDD-PC
⑪	NC
⑫	DVDD-PC
⑬	VPP
⑭	NC

Note) NC : Leave terminal unconnected.

Unit : mm inch

**External circuit**

(1) In case of setting I<sup>2</sup>C slave address of the sensor 1101000

※ Connect terminal 5 (AD\_SELECT) to GND.

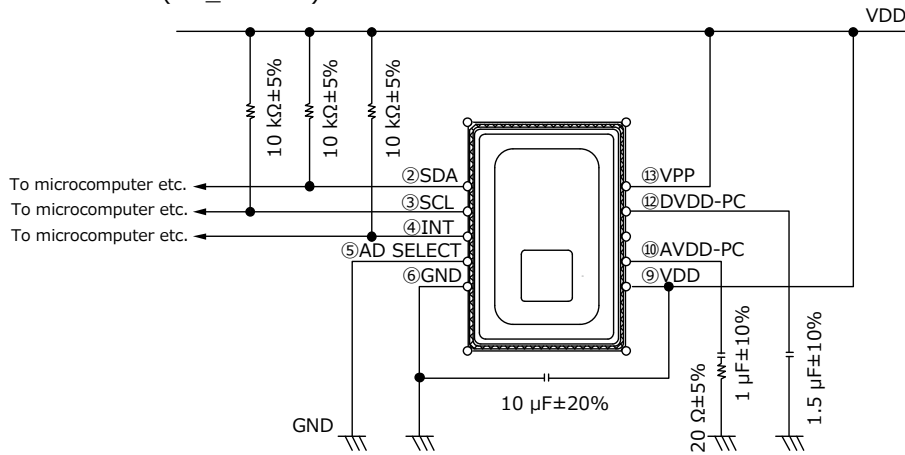

(2) In case of setting I<sup>2</sup>C slave address of the sensor 1101001

※ Connect terminal 5 (AD\_SELECT) to VDD.

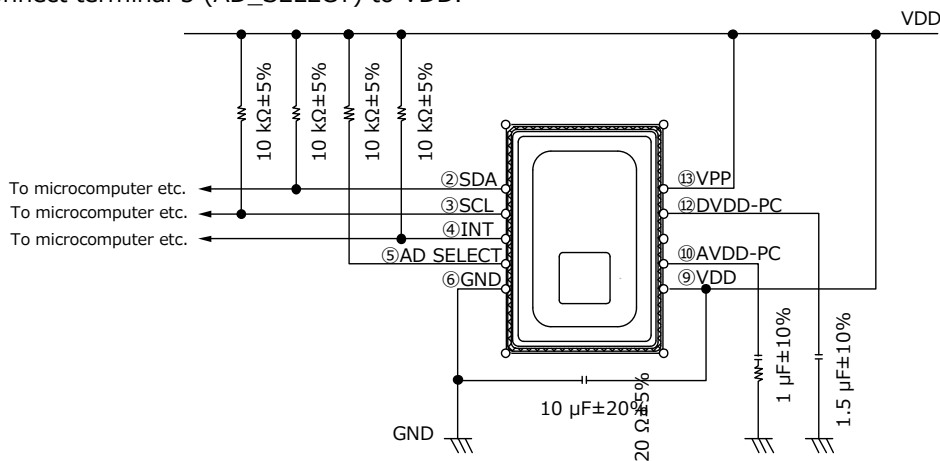

- This circuit is an example to drive Infrared Array Sensor “Grid-EYE”, so that our company will not take any responsibility of loss which is due to this circuit.
- The wiring connected to VDD are same electrical potential (same supply voltage).
- If there is a difference of electric potential between the terminals, it can be cause of breakdown.
- Connect wiring to solid GND with wide and short pattern on PCB.
- If wiring pattern is designed thin and long, temperature accuracy will be degraded.

**Packing format (Tape and reel)**

Tape dimensions (Typical)

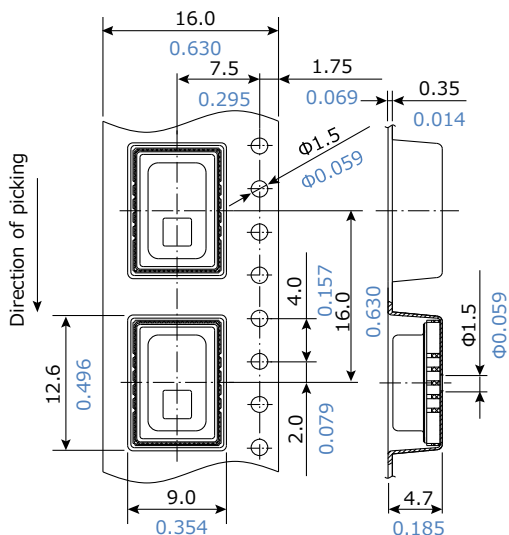

Dimensions of tape reel (Typical)

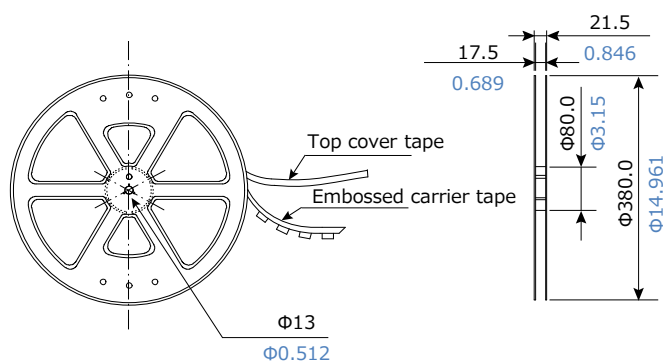

Unit : mm inch

# *Pressure Sensors*

## *PS-A*

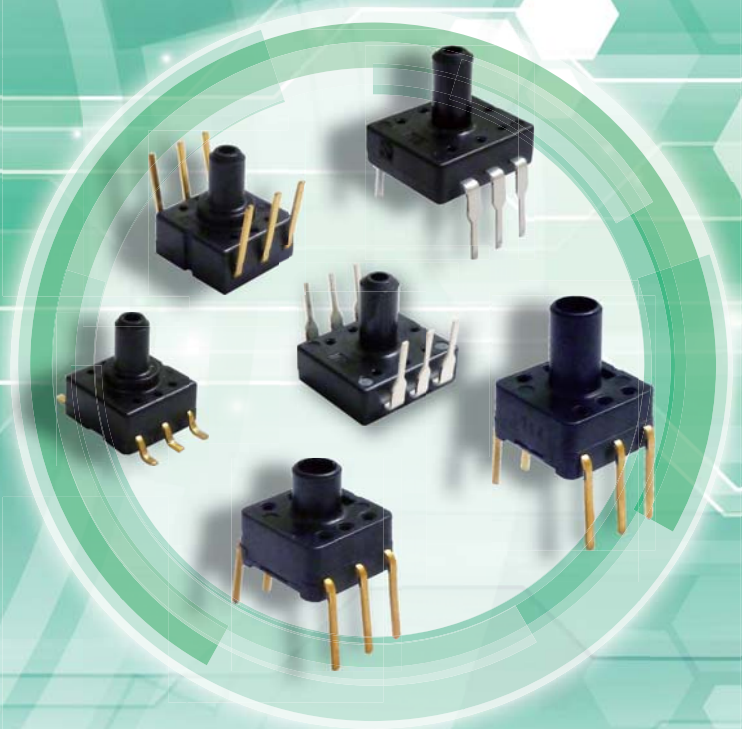

## Notes

## ■ Mounting

Use the land of the printed-circuit board on which the sensor is securely fixed.

## ■ Soldering

Avoid the external thermal influence as the product has a limited thermal capacity due to its compact structure. Heat deformation may damage the sensor or deteriorate its performance. Use the non-corrosive rosin flux. Prevent the flux from entering into the inside of the product as the sensor is exposed to the atmosphere.

## (1) Manual soldering

- Raise the temperature of the soldering tip between 260 and 300 °C 500 and 572 °F (30 W) and solder within 5 seconds.
- The sensor output may vary if the load is applied on the terminal during soldering.
- Keep the soldering tip clean.

## (2) DIP soldering (DIP Terminal)

- Keep the temperature of the DIP solder tank below 260 °C 500 °F and solder within 5 seconds.
- To avoid heat deformation, do not perform DIP soldering when mounting on the circuit board which has a small thermal capacity.

## (3) Reflow soldering (SMD Terminal)

- The recommended reflow temperature profile conditions are given below.

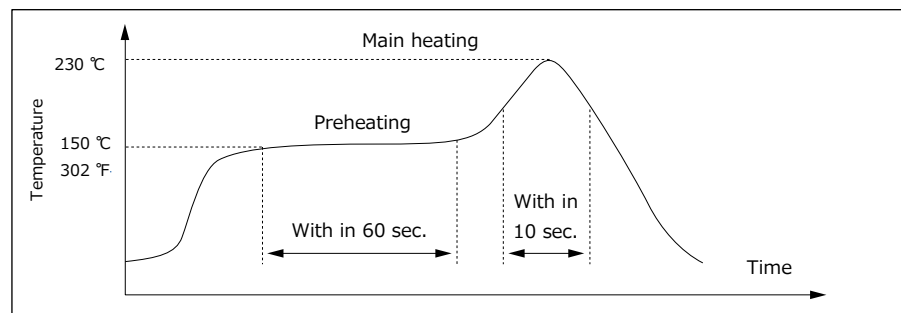

- We recommend the screen solder printing method as the method of cream.
  - Please refer to the recommended PC board specification diagram for the PC board foot pattern.
  - Self alignment may not always work as expected, therefore, please carefully the position of the terminals and pattern.
  - The temperature of the profile is assumed to be a value measured with the printed wiring board of the terminal neighborhood.
  - Please evaluate solderability under the actual mounting conditions since welding and deformation of the pressure inlet port may occur due to heat stress depending on equipments or conditions.
- (4) Rework soldering
- Complete rework at a time.
  - Use a flattened soldering tip when performing rework on the solder bridge. Do not add the flux.
  - Keep the soldering tip below the temperature described in the specifications.
- (5) Avoid drop and rough handling as excessive force may deform the terminal and damage soldering and rough handling as excessive force may deform the terminal and damage soldering
- (6) Keep the circuit board warpage within 0.05 mm of the full width of the sensor.
- (7) After soldering, do not apply stress on the soldered part when cutting or bending the circuit board.
- (8) Prevent human hands or metal pieces from contacting with the sensor terminal.  
Such contact may cause anomalous outlets as the terminal is exposed to the atmosphere.
- (9) After soldering, prevent chemical agents from adhering to the sensor when applying coating to avoid insulation deterioration of the circuit board.
- (10) Please consult us concerning leadfree soldering.

## ■ Wire connection

- (1) Correctly wire as in the connection diagram. Reverse connection may damage the product and degrade the performance.
- (2) Do not use idle terminals to prevent damages to the sensor.

## ■ Cleaning

- (1) Prevent cleaning liquid from entering the inside of the product as the sensor is exposed to the atmosphere.
- (2) Do not perform ultrasonic cleaning in order to prevent damages to the product.

**Notes****■ Environment**

- (1) Avoid use and storage in the corrosive gas (organic solvent, sulfurous acid and hydrogen sulfide gases) which negatively affects the product.
- (2) Install the capacitor on the power supply terminal of the sensor and stabilize supply voltage to maintain a superimposed noise resistance. Recommended installation is to arrange 0.1  $\mu$ F and 1,000 pF in parallel. Before use, check the noise resistance and select/add the optimal capacitor.
- (3) Use surge absorbers as applying the external surge voltage may damage the internal circuit.
- (4) Malfunction may occur near electric noises from static electricity, lightning, broadcast or amateur radio stations and mobile phones
- (5) Avoid use in a place where these products come in contact with water as the sensor does not have a splash proof construction.
- (6) Avoid use in an environment where these products cause dew condensation. When water attached to the sensor chip freezes, the sensor output may be fluctuated or damaged.
- (7) Due to the structure of the pressure sensor chip, the output varies under light. Do not expose the sensor chip to light when applying a voltage by using a transparent tube.
- (8) Do not apply high-frequency oscillation, such as ultrasonic waves, to the product.

**■ Quality check under actual use conditions**

These specifications are for individual components. Before use, carefully check the performance and quality under actual use conditions to enhance stability.

**■ Other precautions**

- (1) The wrong mounting method and the pressure range may invite the risk of accidents.
- (2) Only applicable pressure medium is dry air. Avoid use in the corrosive gas (organic solvent, sulfurous acid and hydrogen sulfide gases) or other mediums containing moisture or foreign substances. Such mediums may damage or break the product.
- (3) The pressure sensor chip is located inside the pressure introduction port. Do not insert foreign substances, such as wires, into the port as those substances may damage the chip and close the port. Do not block the atmosphere introduction port.
- (4) Use electric power within the rated power range. Use beyond the range may damage the product.
- (5) Follow below instructions as static electricity may damage the product.
  - For Storage, short the circuit between terminals by using conductive substances or wrap the whole chip with aluminum foil. For storage and transportation, avoid plastic containers which are easily electrified.
  - Before use, connect electrified materials on desk and operators to the ground in order to safely discharge static electricity.
- (6) Carefully select and fix tubes, introduction pipes and products based on the working voltage. Please contact us for any inquires.
- (7) After mounding the pressure sensor, prevent the potting agent from entering the pressure and the atmosphere introduction ports when coating the circuit board. Use the elastic resin as the heated resin may expand, contract and apply pressure to the sensor. After coating, carefully check if the sensor can be used.



**Pressure Sensor**  
**PS-A series**



**Built-in amplifier and compensating circuit**

**Feature**

- Built-in amplifier and temperature compensation circuit, no need for circuit design and characteristic adjustment.
- High accuracy and reliability : overall accuracy  $\pm 1.25\%$  FS (Standard),  $\pm 2.5\%$  FS (Low-pressure type)
- Compact size, space-saving : compatible size for PS type (Standard/Economy, S and M packages)
- RoHS compliant

**Typical applications**

- Industrial use : Pressure switches and pneumatic components, compressed air pressure measuring devices
- Medical use : Blood pressure meters, oxygen generator and airbeds
- Others : Pressure sensing devices for air pressure mediums  
[Low-pressure type]
- Water level detection for domestic appliances : Washing machines and dishwashers
- Air pressure control : Cleanrooms and smoking rooms
- Medical applications : Breathing pressure measuring devices

**Ordering information**

**ADP5**

Terminal profile	Code	Rated pressure	Code	Package/Pressure inlet hole	Code	Base type
1 : DIP terminal	0	$\pm 100$ kPa	0	S package length : 3 mm 0.118 inch, dia : 3 mm 0.118 inch	Nil	With glass base (Standard type) Low pressure type
	1	-100 kPa	1	M package length : 5 mm 0.197 inch, dia : 3 mm 0.118 inch	1	Without glass base (Economy type)
	2	25 kPa				
2 : SMD terminal	3	50 kPa	2	L package (Only low pressure type) length : 13.5 mm 0.531 inch, dia : 5.45 mm 0.215 inch	2	
	4	100 kPa				
	5	200 kPa				
	6	500 kPa				
	7	1000 kPa				
	A	40 kPa				
	B6	6 kPa (Low pressure type)				
			3	P package (Only low pressure type) length : 15.6 mm 0.615 inch, dia : 5.45 mm 0.215 inch		

Note : Some part numbers may not be available depending on the combination.  
Please refer to the Table of PRODUCT TYPES on the next page.

**Product types**

Standard packing : Carton : 100 pcs.; Case : 1,000 pcs.

Package (Pressure inlet hole length)		Part No.						
		Standard type S package (3 mm 0.118 inch)		Standard / Economy type M package (5 mm 0.118 inch)		Low pressure type		
Pressure	Terminal	DIP terminal	SMD terminal	DIP terminal	SMD terminal	M package (5 mm 0.197 inch)	L package (13.5 mm 0.531 inch)	P package (15.6 mm 0.614 inch)
		<b>Standard</b>						
$\pm 100$ kPa		ADP5100	ADP5200	ADP5101	ADP5201	—	—	—
-100 kPa		ADP5110	ADP5210	ADP5111	ADP5211	—	—	—
25 kPa		ADP5120	—	ADP5121	—	—	—	—
50 kPa		ADP5130	—	ADP5131	—	—	—	—
100 kPa		ADP5140	ADP5240	ADP5141	ADP5241	—	—	—
200 kPa		ADP5150	ADP5250	ADP5151	ADP5251	—	—	—
500 kPa		ADP5160	ADP5260	ADP5161	ADP5261	—	—	—
1000 kPa		ADP5170	ADP5270	ADP5171	ADP5271	—	—	—
<b>Economy type (without glass base)</b>								
40 kPa		—	—	ADP51A11	—	—	—	—
<b>Low pressure type</b>								
6 kPa		—	—	—	—	ADP51B61	ADP51B62	ADP51B63

## Rating

## ● Standard type

Item	Standard type (with glass base)							
Type of pressure	Gauge pressure							
Pressure medium	Air <sup>*1</sup>							
Rated pressure (kPa)	±100	-100	25	50	100	200	500	1000
Max. applied pressure	Twice of the rated pressure							1.5 times the rated pressure
Ambient temperature	-10 °C to +60 °C 14 °F to +140 °F (no freezing or condensation)							
Storage temperature	-20 °C to +85 °C -4 °F to +185 °F (no freezing or condensation)							
Drive voltage	5±0.25 V							
Temperature compensation	0 °C to 50 °C 32 °F to 122 °F							
Offset voltage <sup>*2,3,5</sup>	2.5±0.05	0.5±0.05 V						
Rated output voltage <sup>*2,3,5</sup>	4.5±0.05 (+when +100kPa)	4.5±0.05 V						
Overall accuracy	±1.25 %FS <sup>*3,4,5</sup>							
Current consumption	Max. 10 mA <sup>*2,3</sup>							
Output impedance	15 Ω (Typical) <sup>*2</sup>							
Source current	Max. 0.2 mA <sup>*2,3</sup>							
Sink current	Max. 2 mA <sup>*2,3</sup>							

\*1: Please consult us for pressure media other than air.

\*2: Indicates output when temperature is 25 °C 77 °F.

\*3: Indicates output when drive voltage is 5 V. Although output fluctuates due to fluctuations in the drive voltage, this is not included.

\*4: Overall accuracy indicates the accuracy of the offset voltage and rated output voltage at a temperature compensation range of 0 to 50 °C 32 to 122 °F.

\*5: Accuracy is the value at the time of our shipping. Please set Zero-point calibration function on your products in order to safely use if the offset voltage is shifted.

## ● Economy type

Item	Economy type (without glass base)							
Type of pressure	Gauge pressure							
Pressure medium	Air <sup>*1</sup>							
Rated pressure (kPa)	40							
Max. applied pressure	Twice of the rated pressure							
Ambient temperature	-5 °C to +50 °C 23 °F to +122 °F (no freezing or condensation)							
Storage temperature	-20 °C to +70 °C -4 °F to +158 °F (no freezing or condensation)							
Drive voltage	3±0.15 V							
Temperature compensation	5 °C to 45 °C 41 °F to 113 °F							
Offset voltage	0.3±0.09 V <sup>*2,3,5</sup>							
Span voltage	2.4±0.03 V <sup>*2,3,5</sup>							
Offset voltage temperature characteristics	±4.0 %FS <sup>*3,4,5</sup>							
Sensitivity temperature characteristics	1.3 %FS <sup>*3,4,5</sup>							
Current consumption	Max. 3 mA <sup>*2</sup>							
Output impedance	20 Ω (Typical) <sup>*2,3</sup>							
Source current	Max. 0.15 mA <sup>*2,3</sup>							
Sink current	Max. 1.5 mA <sup>*2,3</sup>							

\*1: Please consult us for pressure media other than air.

\*2: Indicates output when temperature is 25 °C 77 °F.

\*3: Indicates output when drive voltage is 3 V. Although output fluctuates due to fluctuations in the drive voltage, this is not included.

\*4: Indicates from output value at 25 °C 77 °F and the change of output at 5 and 45 °C 41 to 113 °F.

\*5: Accuracy is the value at the time of our shipping. Please set Zero-point calibration function on your products in order to safely use if the offset voltage is shifted.

**Rating**

● Low pressure type

Item	Economy type (without glass base)
Type of pressure	Gauge pressure
Pressure medium	Air*1
Rated pressure (kPa)	6
Max. applied pressure	Twice of the rated pressure
Ambient temperature	0 °C to +70 °C 32 °F to +158 °F (no freezing or condensation)
Storage temperature	-30 °C to +100 °C -22 °F to +212 °F (no freezing or condensation)
Drive voltage	5±0.25 V
Temperature compensation range	0 °C to 70 °C 32 °F to 158 °F
Offset voltage	0.5 V (Typical)*2
Span voltage	4.0 V (Typical)*2
Overall accuracy	±2.5 %FS*2,3,4
Current consumption	Max. 10 mA
Output impedance	50 Ω (Typical)
Source current	Max. 0.2 mA
Sink current	Max. 2.0 mA

\*1: Please consult us for pressure media other than air.

\*2: Indicates output when drive voltage is 5 V. Although output fluctuates due to fluctuations in the drive voltage, this is not included.

\*3: Overall accuracy indicates the accuracy of the offset voltage and span voltage at temperatures between 0 to 70 °C 32 to 158 °F (FS=4V)

\*4: The initial offset voltage error is not included in the overall accuracy.

**Reference data**

**[Standard type]**

1. - ① Output voltage

ADP5170  
 Drive voltage : 5 V  
 Temperature : 25 °C 77 °F  
 Applied pressure : 0 to +1,000 kPa

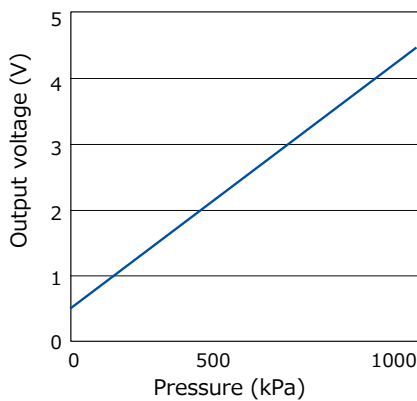

1. - ② Overall accuracy (Offset voltage)

ADP5170  
 Drive voltage : 5 V  
 Temperature : 0 to 50 °C 32 to 122 °F  
 Applied pressure : 0 kPa

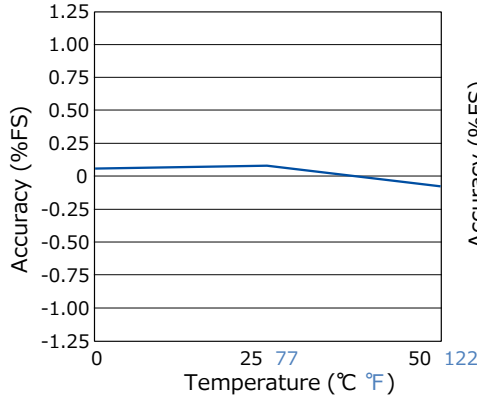

1. - ③ Overall accuracy (Rated output voltage)

ADP5170  
 Drive voltage : 5 V  
 Temperature : 0 to 50 °C 32 to 122 °F  
 Applied pressure : +1,000 kPa

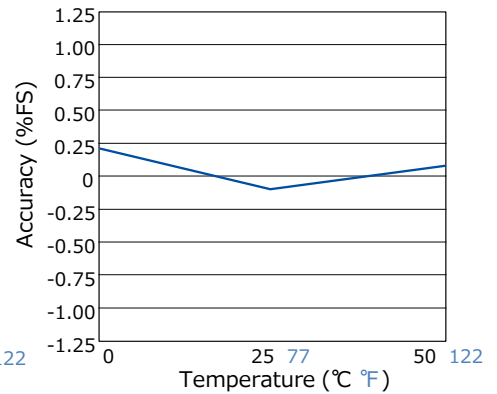

2. - ① Output voltage

ADP5100  
 Drive voltage : 5 V  
 Temperature : 25 °C 77 °F  
 Applied pressure : -100 to +100 kPa

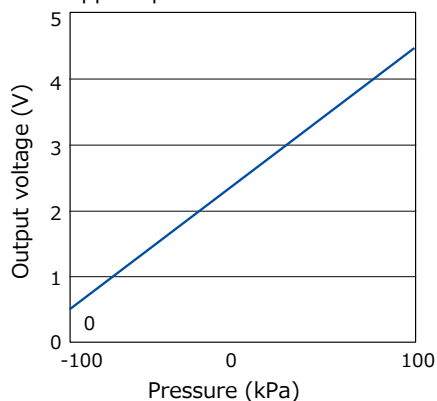

2. - ② Overall accuracy (Offset voltage)

ADP5100  
 Drive voltage : 5 V  
 Temperature : 0 to 50 °C 32 to 122 °F  
 Applied pressure : 0 kPa

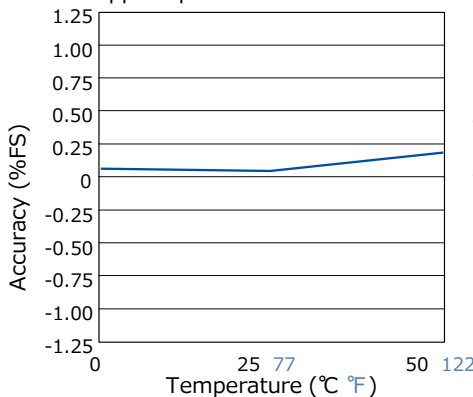

2. - ③ Overall accuracy (Rated output voltage)

ADP5100  
 Drive voltage : 5 V  
 Temperature : 0 to 50 °C 32 to 122 °F  
 Applied pressure : +100 kPa

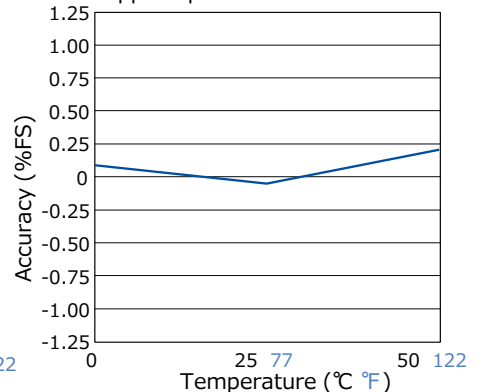

**Reference data**

**[Low pressure type]**

**1. Output voltage**

ADP51B61

Drive voltage : 5 V

Temperature : 25 °C 77 °F

Applied pressure : 0 to 6 kPa

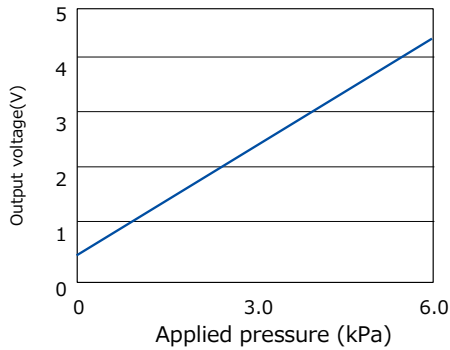

**2. THB (high temperature high humidity bias test)**

ADP51B61

Within 85 °C 185 °F and 85% RH

5 V applied between No.2 (Vdd) and No.3 (GND)

Applied pressure : 0 kPa

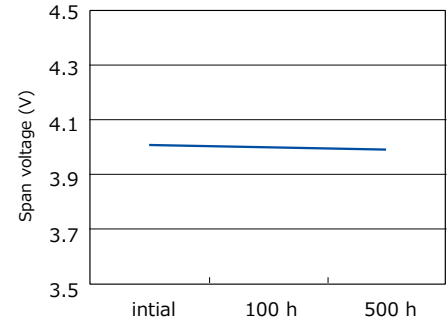
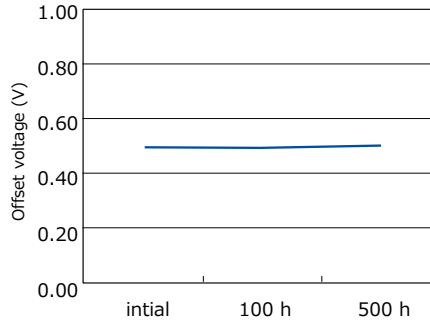

**3. Ambient temperature characteristics**

Ambient temperature : 25 °C 77 °F → 0 °C 32 °F → 10 °C 50 °F → 60 °C 140 °F → 70 °C 158 °F

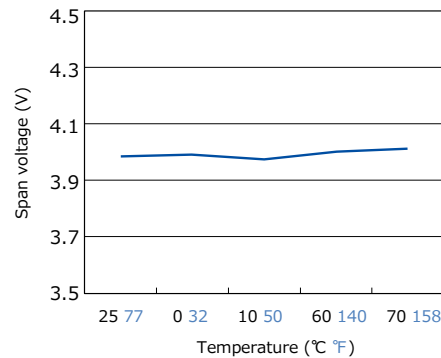
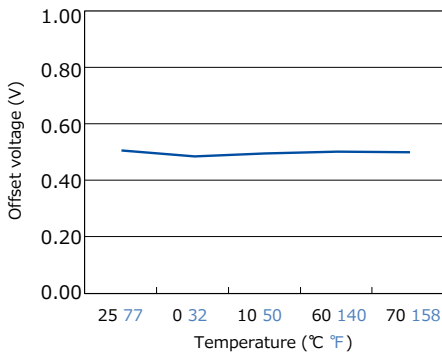

**4. Shock test**

ADP51B61

Shock applied (981 m/s<sup>2</sup>, 3 times in x, y and z directions)

Applied pressure : 0 kPa

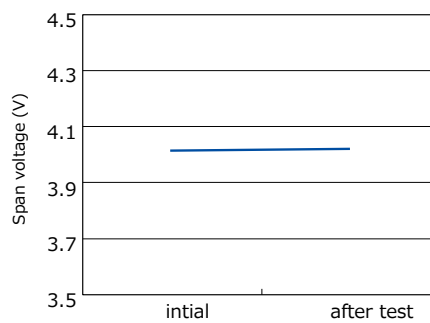
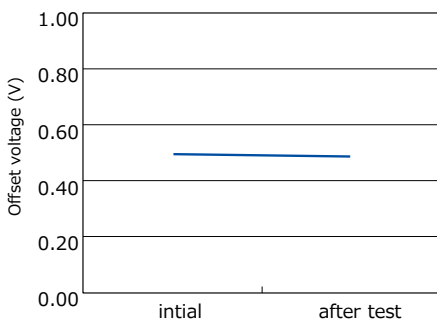

**5. Vibration test**

ADP51B61

Vibration applied (10 to 55 Hz, amplitude : 1.5mm, x, y and z directions, 2 hrs each)

Applied pressure : 0 kPa

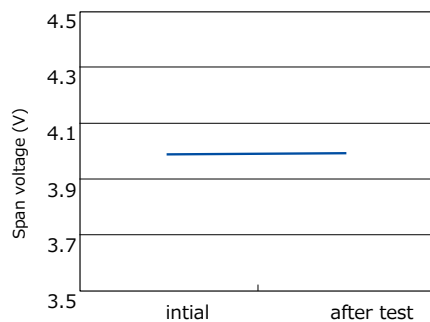
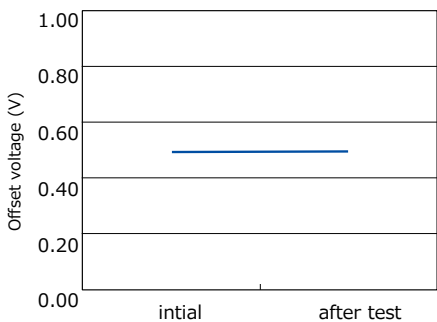

**Reference data**

6. Temperature/humidity cycle test

ADP51B61

Exposed to 10 cycles in the temperature and humidity conditions given below.

Applied pressure : 0 kPa

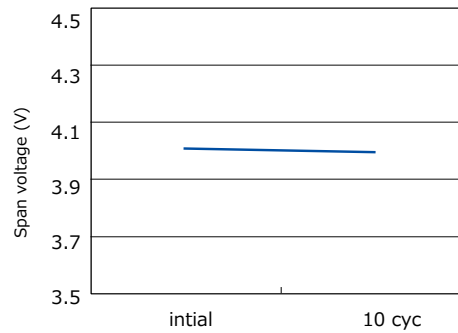
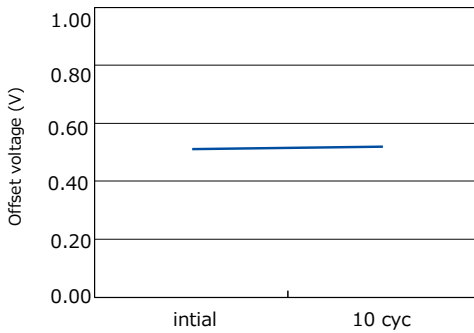
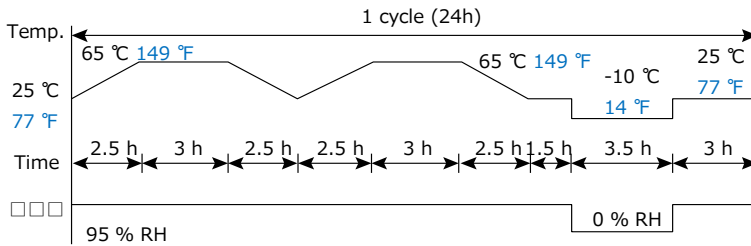

**Evaluation test**

Classification	Tested item	Tested condition	Result
Environmental characteristics	Storage at high temperature	Temperature : Left in a 85 °C 185 °F constant temperature bath Time : 100 hrs	Passed
	Storage at low temperature	Temperature : Left in a -20 °C -4 °F constant temperature bath Time : 100 hrs	Passed
	Humidity	Temperature/humidity : Left at 40 °C 104 °F, 90 % RH Time : 100 時間	Passed
	Temperature cycle	Temperature : -20 °C to 85 °C -4 °F to 185 °F 1 cycle : 30 min Times of cycle : 100 cycle	Passed
Endurance characteristics	High temperature/high humidity operation	Temperature/humidity : 40 °C 104 °F, 90% RH Operation times : 10 <sup>6</sup> , rated voltage applied	Passed
Mechanical characteristics	Vibration resistance	Double amplitude : 1.5 mm 0.059 inch Vibration : 10 to 55 Hz Applied vibration direction : X, Y, Z 3 directions Time : 2 hrs each	Passed
	Dropping resistance	Dropping height : 75 cm 29.528 inch Times : 2 times	Passed
	Terminal strength	Pulling strength : 9.8 N {1 kgf}, 10 sec Bending strength : 4.9 N {0.5 kgf}, left and right 90 ° 1 time	Passed
Soldering characteristics	Solderability	Temperature : 230 °C 446 °F Time : 5 sec	Passed
	Heat resistance (DIP)	Temperature : 260 °C 500 °F Time : 10 sec	Passed

Note: For details other than listed above, please consult us.

Items	Criteria
Offset voltage	Variation amount
Output span voltage	within ±2.5 %FS of value

**Dimensions**

The CAD data of the products with a **CAD data** mark can be downloaded from: <http://industrial.panasonic.com/>

- Standard type S package (Terminal direction : DIP terminal Pressure inlet hole length : 3 mm 0.118 inch)

**CAD data**

Terminal No.	Name
1	Vcc (Power supply ⊕)
2	NC (No connection)
3	Vout (Output)
4	NC (No connection)
5	NC (No connection)
6	GND (Ground)

Unit : mm inch, General tolerance ±0.3 ±0.012

- Standard type S package (Terminal direction : SMD terminal Pressure inlet hole length : 3 mm 0.118 inch) ADP5□□0

**CAD data**

Terminal No.	Name
1	Vcc (Power supply ⊕)
2	NC (No connection)
3	Vout (Output)
4	NC (No connection)
5	NC (No connection)
6	GND (Ground)

Unit : mm inch, General tolerance ±0.3 ±0.012

**Dimensions**

The CAD data of the products with a **CAD data** mark can be downloaded from: <http://industrial.panasonic.com/>

- Standard/Economy type M package (Terminal direction : DIP terminal Pressure inlet hole length : 5 mm 0.197 inch)  
ADP51□1/ADP51A11

**CAD data**

**Recommended PC board**

**Terminal connection diagram**

Terminal No.	Name
1	Vcc (Power supply ⊕)
2	NC (No connection)
3	Vout (Output)
4	NC (No connection)
5	NC (No connection)
6	GND (Ground)

Unit : mm inch, General tolerance ±0.3 ±0.012

- Standard type M package (Terminal direction : SMD terminal Pressure inlet hole length : 5 mm 0.197 inch) ADP52□1

**CAD data**

**Recommended PC board**

**Terminal connection diagram**

Terminal No.	Name
1	Vcc (Power supply ⊕)
2	NC (No connection)
3	Vout (Output)
4	NC (No connection)
5	NC (No connection)
6	GND (Ground)

Unit : mm inch, General tolerance ±0.3 ±0.012

**Dimensions**

The CAD data of the products with a **CAD data** mark can be downloaded from: <http://industrial.panasonic.com/>

- Low pressure type M package (Terminal direction : DIP terminal, Pressure inlet hole length : 5 mm 0.197 inch) ADP51B61

**CAD data**

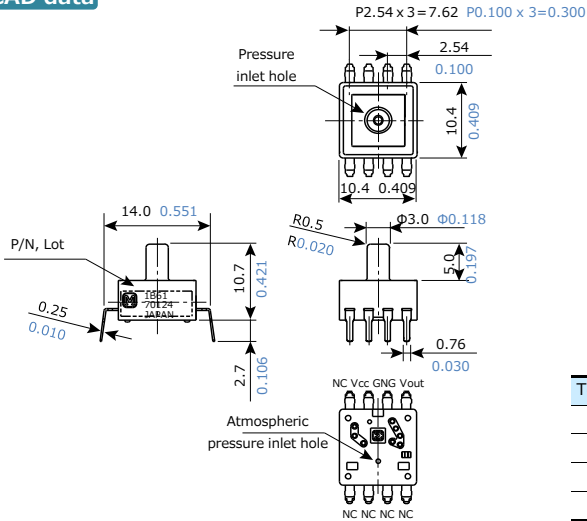

Recommended PC board pattern (TOP VIEW)

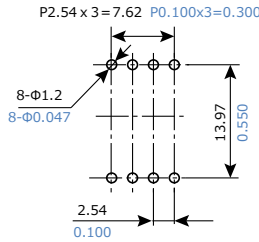

Terminal connection diagram

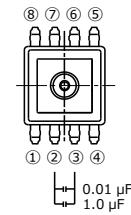

Unit : mm inch, General tolerance  $\pm 0.3 \pm 0.012$

Terminal No.	Name
1	NC (No connection)
2	Vcc (Power supply $\oplus$ )
3	GND (Ground)
4	Vout (Output)

Terminal No.	Name
5	NC (No connection)
6	NC (No connection)
7	NC (No connection)
8	NC (No connection)

- Low pressure type L Package (Terminal direction : DIP terminal, Pressure inlet hole length : 13.5 mm 0.531 inch) ADP51B62

**CAD data**

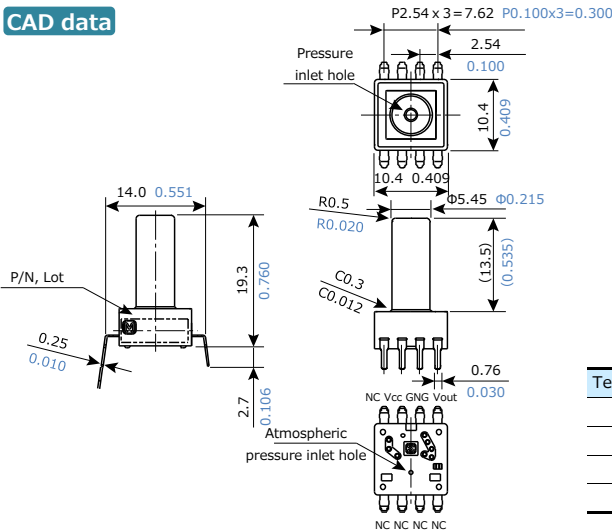

Recommended PC board pattern (BOTTOM)

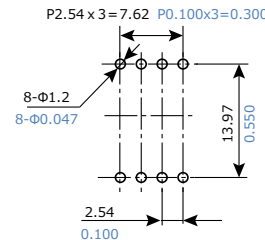

Terminal connection diagram

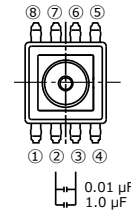

Unit : mm inch, General tolerance  $\pm 0.3 \pm 0.012$

Terminal No.	Name
1	NC (No connection)
2	Vcc (Power supply $\oplus$ )
3	GND (Ground)
4	Vout (Output)

Terminal No.	Name
5	NC (No connection)
6	NC (No connection)
7	NC (No connection)
8	NC (No connection)

- Low pressure type P package (Terminal direction : DIP terminal, Pressure inlet hole length : 15.6 mm 0.614 inch) ADP51B63

**CAD data**

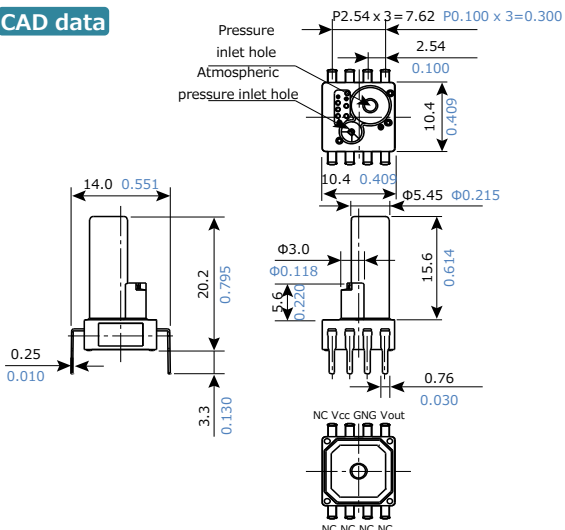

Recommended PC board pattern (BOTTOM)

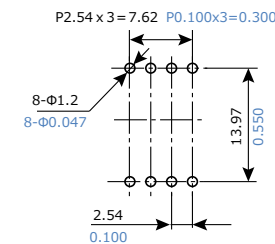

Terminal connection diagram

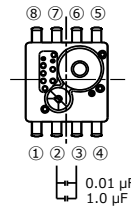

Unit : mm inch, General tolerance  $\pm 0.3 \pm 0.012$

Terminal No.	Name
1	NC (No connection)
2	Vcc (Power supply $\oplus$ )
3	GND (Ground)
4	Vout (Output)

Terminal No.	Name
5	NC (No connection)
6	NC (No connection)
7	NC (No connection)
8	NC (No connection)



# *Pressure Sensors*

## *PS / PF*

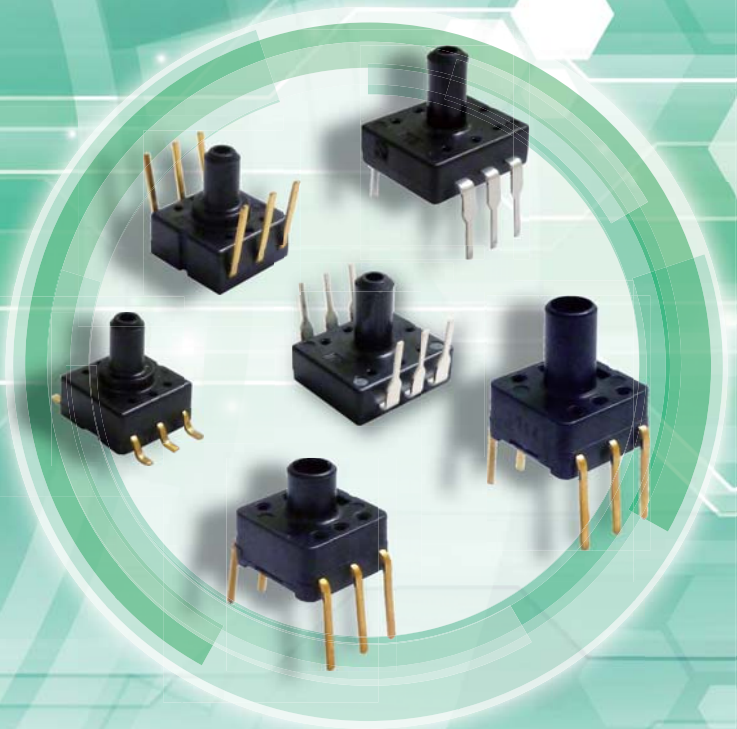

## Notes

## ■ Mounting

Use the land of the printed-circuit board on which the sensor is securely fixed.

## ■ Soldering

Avoid the external thermal influence as the product has a limited thermal capacity due to its compact structure. Heat deformation may damage the sensor or deteriorate its performance. Use the non-corrosive rosin flux. Prevent the flux from entering into the inside of the product as the sensor is exposed to the atmosphere.

## (1) Manual soldering

- Raise the temperature of the soldering tip between 260 and 300 °C 500 and 572 °F (30 W) and solder within 5 seconds.
- The sensor output may vary if the load is applied on the terminal during soldering.
- Keep the soldering tip clean.

## (2) DIP soldering (DIP Terminal)

- Keep the temperature of the DIP solder tank below 260 °C 500 °F and solder within 5 seconds.
- To avoid heat deformation, do not perform DIP soldering when mounting on the circuit board which has a small thermal capacity.

## (3) Reflow soldering (SMD Terminal)

- The recommended reflow temperature profile conditions are given below.

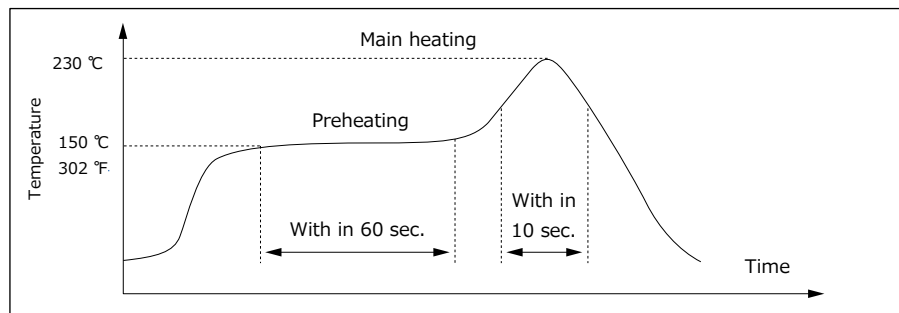

- We recommend the screen solder printing method as the method of cream.
  - Please refer to the recommended PC board specification diagram for the PC board foot pattern.
  - Self alignment may not always work as expected, therefore, please carefully the position of the terminals and pattern.
  - The temperature of the profile is assumed to be a value measured with the printed wiring board of the terminal neighborhood.
  - Please evaluate solderability under the actual mounting conditions since welding and deformation of the pressure inlet port may occur due to heat stress depending on equipments or conditions.
- (4) Rework soldering
- Complete rework at a time.
  - Use a flattened soldering tip when performing rework on the solder bridge. Do not add the flux.
  - Keep the soldering tip below the temperature described in the specifications.
- (5) Avoid drop and rough handling as excessive force may deform the terminal and damage soldering and rough handling as excessive force may deform the terminal and damage soldering
- (6) Keep the circuit board warpage within 0.05 mm of the full width of the sensor.
- (7) After soldering, do not apply stress on the soldered part when cutting or bending the circuit board.
- (8) Prevent human hands or metal pieces from contacting with the sensor terminal.  
Such contact may cause anomalous outlets as the terminal is exposed to the atmosphere.
- (9) After soldering, prevent chemical agents from adhering to the sensor when applying coating to avoid insulation deterioration of the circuit board.
- (10) Please consult us concerning leadfree soldering.

## ■ Cleaning

- (1) Prevent cleaning liquid from entering the inside of the product as the sensor is exposed to the atmosphere.
- (2) Do not perform ultrasonic cleaning in order to prevent damages to the product.

## Notes

## ■ Environment

- (1) Avoid use and storage in the corrosive gas (organic solvent, sulfurous acid and hydrogen sulfide gases) which negatively affects the product.
- (2) Avoid use in a place where these products come in contact with water as the sensor does not have a splashproof construction.
- (3) Avoid use in an environment where these products cause dew condensation.  
When water attached to the sensor chip freezes, the sensor output may be fluctuated or damaged.
- (4) Due to the structure of the pressure sensor chip, the output varies under light.  
Do not expose the sensor chip to light when applying a voltage by using a transparent tube.
- (5) Do not apply high-frequency oscillation, such as ultrasonic waves, to the product.

## ■ Quality check under actual use conditions

These specifications are for individual components. Before use, carefully check the performance and quality under actual use conditions to enhance stability.

## ■ Other precautions

- (1) The wrong mounting method and the pressure range may invite the risk of accidents.
- (2) Only applicable pressure medium is dry air. Avoid use in the corrosive gas (organic solvent, sulfurous acid and hydrogen sulfide gases) or other mediums containing moisture or foreign substances. Such mediums may damage or break the product.
- (3) The pressure sensor chip is located inside the pressure introduction port. Do not insert foreign substances, such as wires, into the port as those substances may damage the chip and close the port. Do not block the atmosphere introduction port.
- (4) Use electric power within the rated power range. Use beyond the range may damage the product.
- (5) Follow below instructions as static electricity may damage the product.
  - For Storage, short the circuit between terminals by using conductive substances or wrap the whole chip with aluminum foil. For storage and transportation, avoid plastic containers which are easily electrified.
  - Before use, connect electrified materials on desk and operators to the ground in order to safely discharge static electricity.
- (6) Carefully select and fix tubes, introduction pipes and products based on the working voltage. Please contact us for any inquires.

## Application circuit diagram (Example)

The pressure sensor converts a voltage by constant current drive and if necessary, amplifies the voltage.

The circuit on the right is a typical use example.

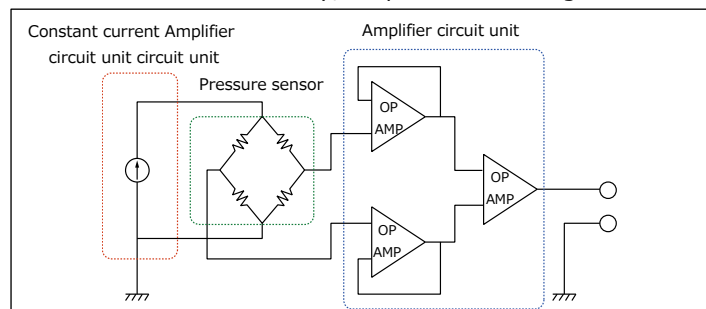

## Mounting method

The general method of air pressure transmission varies depending on the low/high pressure condition.

## ● Usage note

- ① Select a sturdy pressure introduction pipe to avoid pressure leak.
- ② Securely fix the pressure introduction pipe to avoid pressure leak.
- ③ Do not block the pressure introduction pipe.

Methods of transmitting air pressures

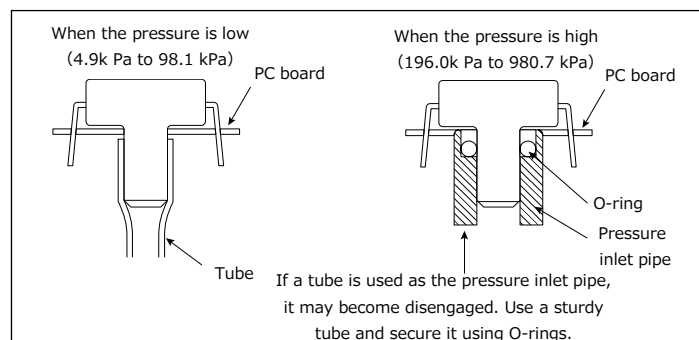

**Pressure Sensor**  
**PS/PF series**



**High precision pressure sensor (without amp.)** PS Pressure sensor

PF Pressure sensor

**Feature**

- Compact size (PS type)
- High accuracy and liner characteristic
- Broad line-up
- RoHS compliant

**Typical applications**

- Industrial use : Pressure switches and pneumatic components, compressed air pressure measuring devices and airbeds
- Medical use : Blood pressure meters, oxygen generator and airbeds
- Others : Pressure sensing devices for air pressure mediums

**Ordering information**

**ADP**

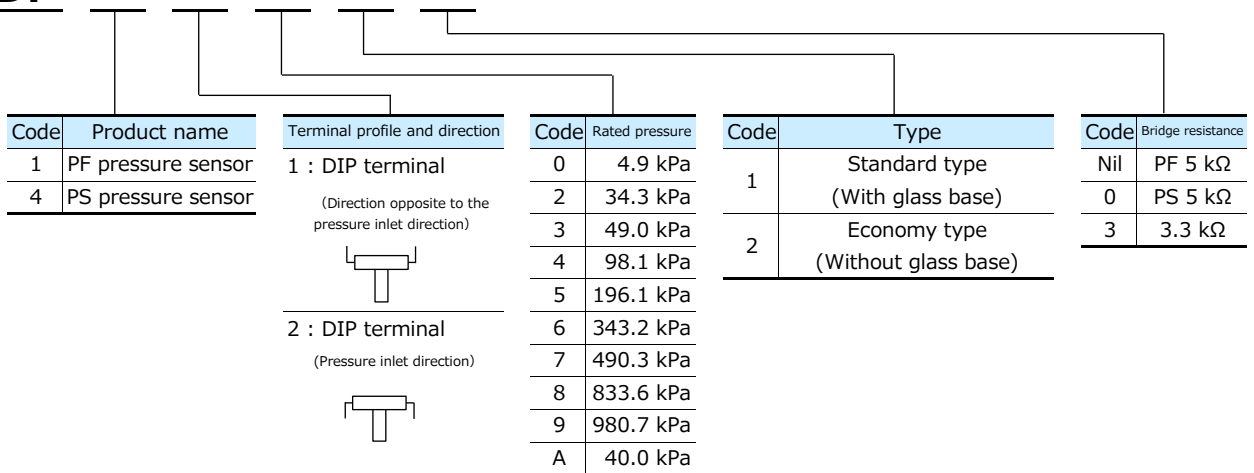

**Types**

Standard packing : Carton : 100 pcs.; Case : 1,000 pcs.

Pressure	Bridge resistance	Part No.									
		PS pressure sensor					PF pressure sensor				
		5 kΩ		3.3 kΩ			5 kΩ		3.3 kΩ		
Terminal											
<b>Standard type (with glass base)</b>											
4.9 kPa	ADP41010	ADP42010	—	—	—	ADP1101	ADP1201	—	—	—	
34.3 kPa	ADP41210	ADP42210	—	—	—	ADP1121	ADP1221	—	—	—	
49.0 kPa	ADP41310	ADP42310	—	—	—	ADP1131	ADP1231	—	—	—	
98.1 kPa	ADP41410	ADP42410	ADP4932	ADP41413	ADP42413	ADP1141	ADP1241	—	—	—	
196.1 kPa	ADP41510	ADP42510	—	—	—	ADP1151	ADP1251	—	—	—	
343.2 kPa	ADP41610	ADP42610	—	—	—	ADP1161	ADP1261	—	—	—	
490.3 kPa	ADP41710	ADP42710	—	—	—	ADP1171	ADP1271	—	—	—	
833.6 kPa	ADP41810	ADP42810	—	—	—	ADP1181	ADP1281	—	—	—	
980.7 kPa	ADP41910	ADP42910	ADP4933	ADP41913	ADP42913	ADP1191	ADP1291	—	—	—	
<b>Economy type (without glass base)</b>											
40.0 kPa	—	—	—	ADP41A23	ADP42A23	—	—	ADP11A23	ADP12A23	—	

Rating								
Type	Standard type (With glass base)						Economy type (Without glass base)	
Type of pressure	Gauge pressure							
Pressure medium	Air*1							
Rated pressure (kPa)	4.9	34.3 to 343.2	490.3	833.6	980.7	98.1*2	980.7*2	40.0
Max. applied pressure	Twice of the rated pressure		1.5 times of the rated pressure		Twice of the rated pressure	1.5 times of the rated pressure	Twice of the rated pressure	
Bridge resistance	5,000 Ω ± 1,000 Ω					3,300 Ω ± 700 Ω		3,300 Ω ± 600 Ω
Ambient temperature	-20 °C to +100 °C -4 °F to +212 °F (no freezing or condensation)						-5 °C to +50 °C	
Storage temperature	-40 °C to +120 °C -40 °F to +248 °F (no freezing or condensation)						23 °F to +122 °F	
Standard temperature	25 °C 77 °F					30 °C 86 °F		25 °C 77 °F
Temperature compensation range	0 °C to 50 °C 32 °F to +122 °F					0 °C to 60 °C		5 °C to 45 °C
Drive current (constant current)	1.5 mA					1.0 mA		1.5 mA
Output span voltage	40 ± 20 mV	100 ± 40 mV				65 ± 25 mV		43.5 ± 22.5 mV
Offset voltage	±20 mV							
Linearity	±0.7 %FS	±0.3 %FS	±0.5 %FS	±0.6 %FS		±1.0 %FS		±0.3 %FS
Pressure hysteresis	±0.6 %FS	±0.2 %FS	±0.4 %FS			±1.0 %FS		±0.7 %FS
Offset voltage-temperature characteristics*3	±15 %FS	±5.0 %FS				±3.5 %FS		±10 %FS
Sensitivity-temperature	±10 %FS	±2.5 %FS						±1.3 %FS

\*1: Please consult us if a pressure medium other than air is to be used.

\*2: For PS pressure sensor only

\*3: This is the regulation which applies within the compensation temperature range.

◆ Unless otherwise specified, measurements were taken with a drive current of ±0.01 mA and humidity ranging from 25% to 85%.

◆ Please consult us if the intended use involves a negative pressure.

**Reference data**

**[PS pressure sensor]**

● Characteristics data

1.-(1) Output characteristics

AD41913  
Drive current : 1.0 mA  
Temperature : 30 °C 86 °F

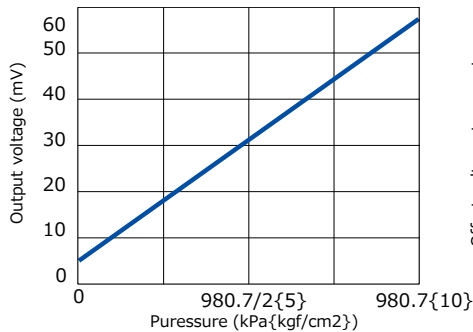

1.-(2) Offset voltage - temperature characteristics

AD41913  
Drive current : 1.0 mA  
Rating : ±3.5 %FS

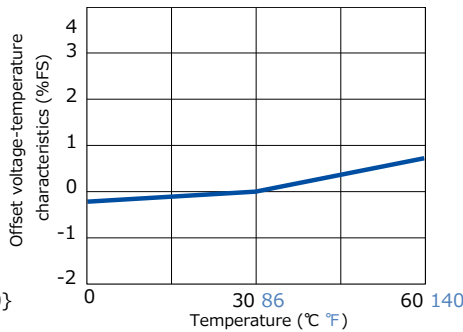

1.-(3) Sensitivity -temperature characteristics

AD41913  
Drive current : 1.0 mA  
Rating : ±2.5 %FS

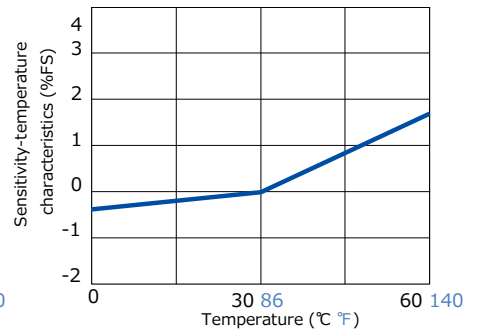

● Pressure cycle range (0 to rated pressure)

Tested sample : ADP41913, temperature : 100 °C 212 °F, No. of cycle: 1 × 10<sup>6</sup>

Offset voltage range

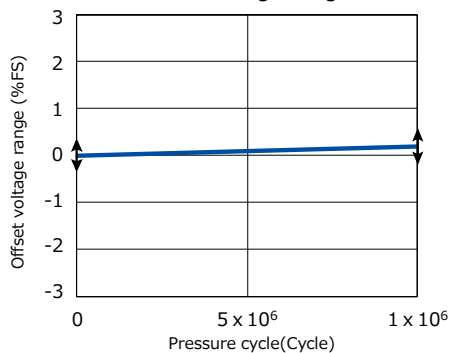

Output span voltage range

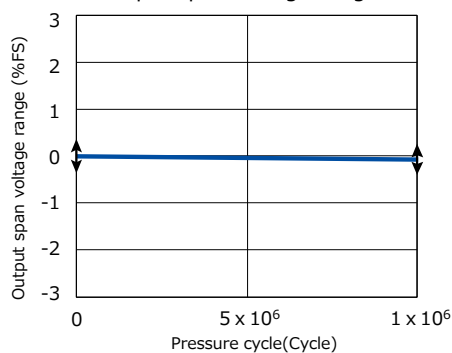

Even after testing for 1 million times, the variations in the offset voltage and output span voltage are minimal.

**Reference data**

**[PF pressure sensor]**

● Characteristics data

1. -① Output characteristics

AD1141  
Drive current : 1.5 mA  
Temp. : 30 °C 86 °F

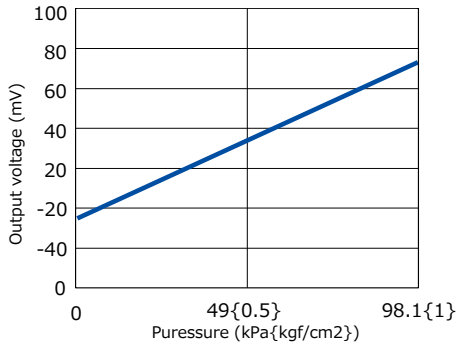

1. -② Offset voltage - temperature characteristics

AD1141  
Drive current : 1.5 mA  
Rating : ±5 %FS

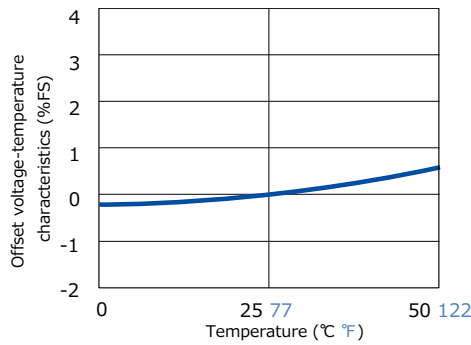

1. -③ Sensitivity - temperature characteristics

AD1141  
Drive current : 1.5 mA  
Rating : ±2.5%FS

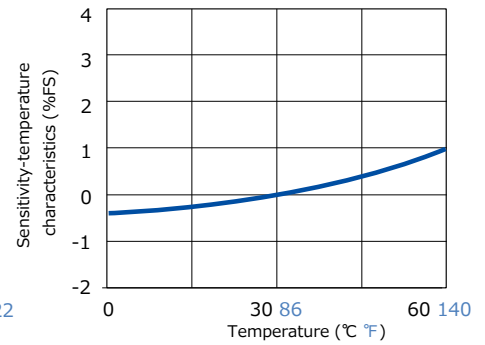

● Pressure cycle range (0 to rated pressure)

Tested sample : ADP1131, temperature : 25 °C 77 °F

Offset voltage range

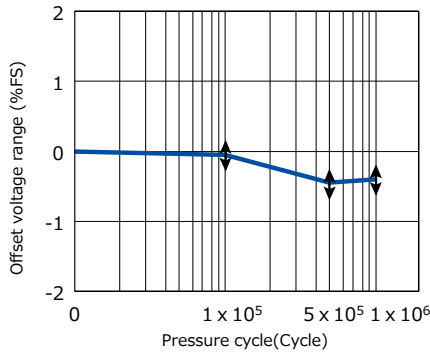

Output span voltage range

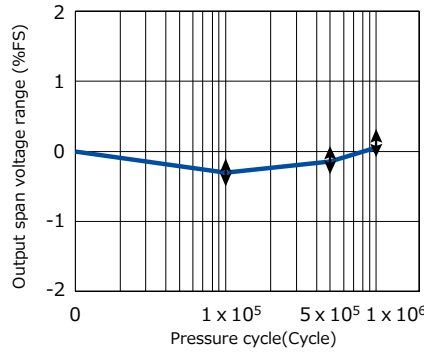

**Evaluation test**

Classification	Tested item	Tested condition	Result
Environmental characteristics	Storage at high temperature	Temperature : Left in a 120 °C 248 °F constant temperature bath Time : 1000 h	Passed
	Storage at low temperature	Temperature : Left in a -40 °C -40 °F constant temperature bath Time : 1000 h	Passed
	Humidity	Temperature/humidity : Left at 40 °C 104 °F, 90 % RH Time : 1000 h	Passed
	Temperature cycle	Temperature : -40 °C to 120 °C -40 °F to 248 °F 1 cycle : 30 Min. Times of cycle : 100	Passed
Endurance characteristics	High temperature/high humidity operation	Temperature/humidity : 40 °C 104 °F, 90% RH Operation times : 10 <sup>6</sup> , rated voltage applied.	Passed
Mechanical characteristics	Vibration resistance	Double amplitude : 1.5 mm {0.059 inch} Vibration : 10 ~ 55 Hz Applied vibration direction : X, Y, Z 3 directions Time : 2 hrs each	Passed
	Dropping resistance	Dropping height : 75 cm Times : 2 times	Passed
	Terminal strength	Pulling strength : 9.8 N {1 kgf}, 10 sec. Bending strength : 4.9 N {0.5 kgf}, left and right 90 ° 1 time	Passed
Soldering characteristics	Solderability	Temperature : 230 °C 446 °F Time : 5 sec	Passed
	Heat resistance (DIP)	Temperature : 260 °C 500 °F Time : 10 sec	Passed

Note: For details other than listed above, please consult us.

Items	Criteria
Offset voltage	Variation amount
Output span voltage	within ±5.0 %FS of value

**Dimensions**

The CAD data of the products with a **CAD data** mark can be downloaded from: <http://industrial.panasonic.com/>

**[PS pressure sensor]**

● Terminal direction : DIP terminal Direction opposite to the pressure inlet direction ADP41□□□

**CAD data**

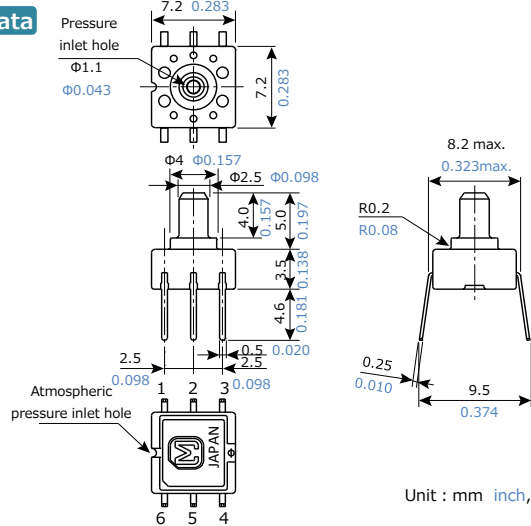

**Recommended PC board pattern (BOTTOM VIEW)**

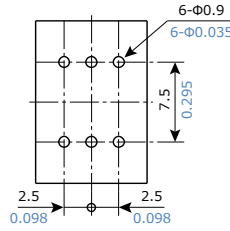

**Terminal connection diagram**

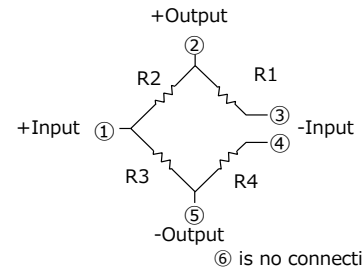

Terminal No.	Name
1	Power supply (+)
2	Output (+)
3	Power supply (-)
4	Power supply (-)
5	Output (-)
6	NC (No connection)

Note: Leave terminal 6 unconnected.

● Terminal direction : DIP terminal Pressure inlet direction ADP42□□□

**CAD data**

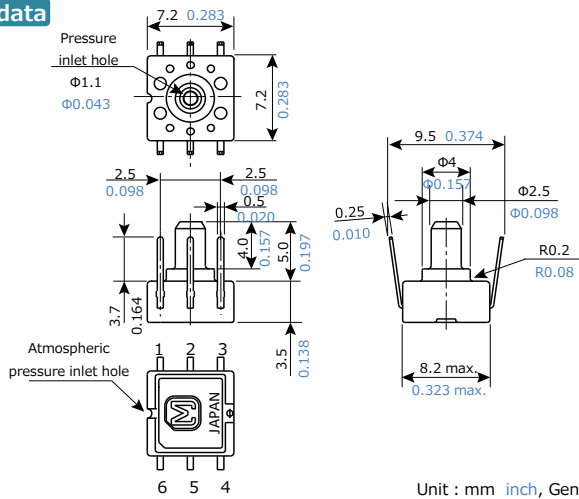

**Recommended PC board pattern (BOTTOM VIEW)**

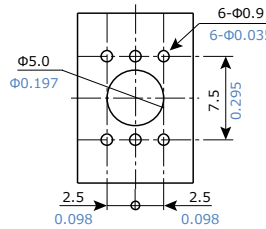

**Terminal connection diagram**

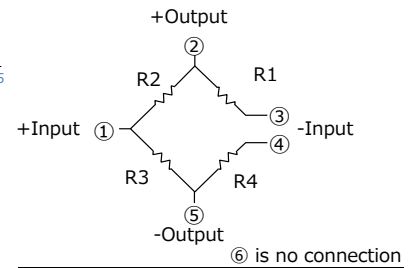

Terminal No.	Name
1	Power supply (+)
2	Output (+)
3	Power supply (-)
4	Power supply (-)
5	Output (-)
6	NC (No connection)

Note: Leave terminal 6 unconnected.

● Terminal direction : SMD terminal ADP4932, ADP4933

**CAD data**

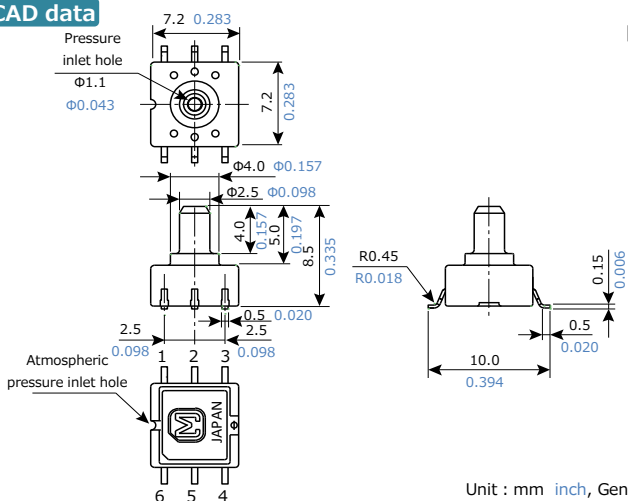

**Recommended PC board pattern (BOTTOM VIEW)**

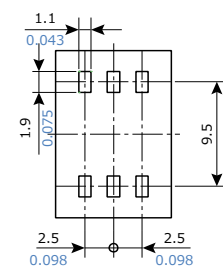

**Terminal connection diagram**

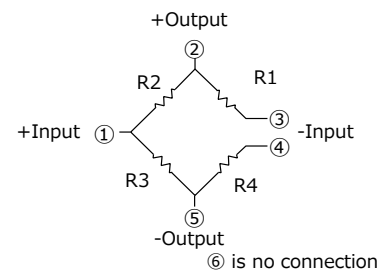

Terminal No.	Name
1	Power supply (+)
2	Output (+)
3	Power supply (-)
4	Power supply (-)
5	Output (-)
6	NC (No connection)

Note: Leave terminal 6 unconnected.

Dimensions

The CAD data of the products with a **CAD data** mark can be downloaded from: <http://industrial.panasonic.com/>

**[PF pressure sensor]**

- Terminal direction : DIP terminal Direction opposite to the pressure inlet direction ADP11□□(□)

**CAD data**

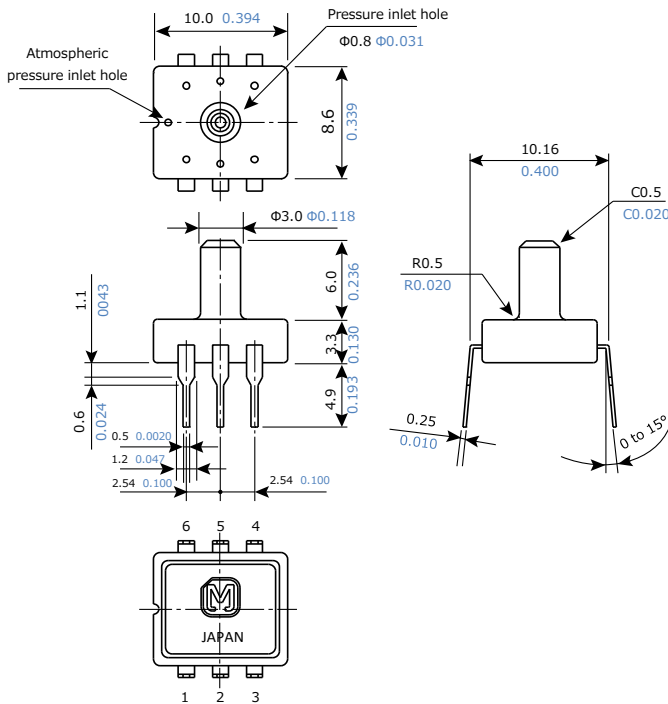

Recommended PC board pattern (BOTTOM VIEW)

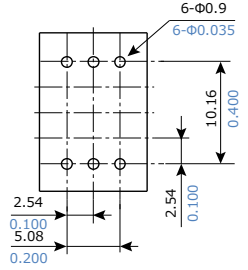

Terminal connection diagram

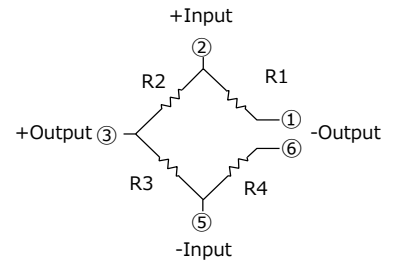

Terminal No.	Name
1	-Output (-)
2	Power supply (+)
3	+Output (+)
4	No connection
5	Power supply (-)
6	-Output (-)

Note: Leave terminal 4 unconnected.

unit : mm inch, General tolerance :  $\pm 0.3 \pm 0.012$

- Terminal direction : DIP terminal Pressure inlet direction ADP12□□(□)

**CAD data**

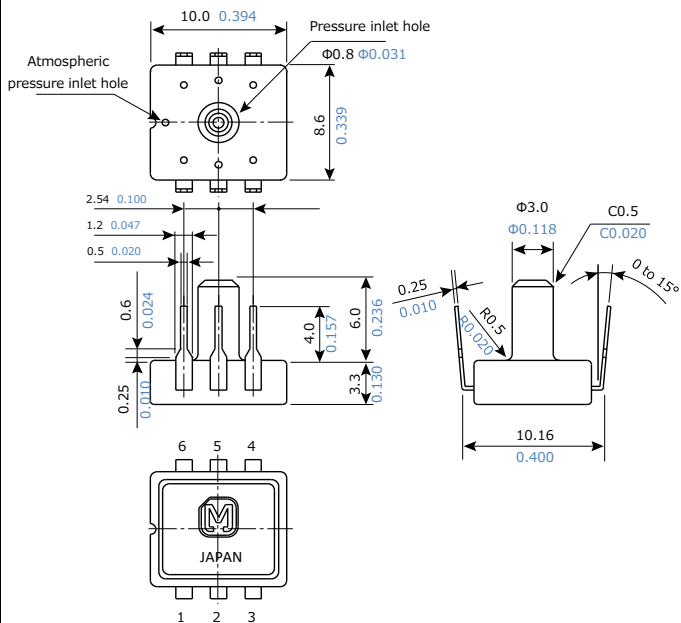

Recommended PC board pattern (BOTTOM VIEW)

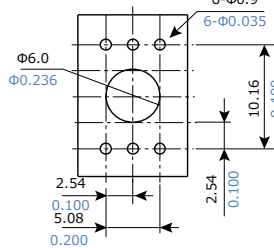

Terminal connection diagram

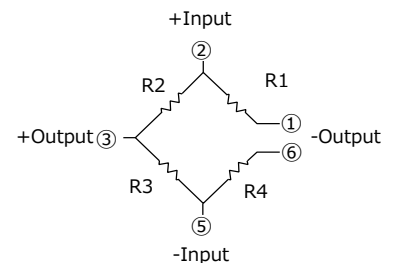

Terminal No.	Name
1	-Output (-)
2	Power supply (+)
3	+Output (+)
4	No connection
5	Power supply (-)
6	-Output (-)

Note: Leave terminal 4 unconnected.

unit : mm inch, General tolerance :  $\pm 0.3 \pm 0.012$



## EXPLANATION OF TERMS

## ■ Pressure object

This is what can be used to activate the pressure sensor.  
(The Panasonic Corporation pressure sensor can be used with gas.)

## ■ Rated pressure

The pressure value up to which the specifications of the pressure sensor are guaranteed.

## ■ Maximum applied pressure

The maximum pressure that can be applied to the pressure sensor, after which, when the pressure is returned to below the rated pressure range, the specifications of the pressure sensor are guaranteed.

## ■ Temperature compensation range

The temperature range across which the specification values of the pressure sensor are guaranteed.

## ■ Drive current (voltage)

The supply current (voltage) required to drive a pressure sensor.

## ■ Output span voltage

The difference between the rated output voltage and the offset voltage. The output span voltage is also called the full-scale voltage (FS).

## ■ Offset voltage

The output voltage of a pressure sensor when no pressure is applied.

## ■ Rated pressure output voltage

Output voltage when rated pressure is applied.

## ■ Linearity

When the pressure is varied from no load to the rated pressure, the linearity is the amount of shift between the straight line that joins the no-load voltage value and the rated pressure voltage value (expressed as the ratio of the amount of shift (D1) at half of the rated pressure value with respect to the full scale voltage (FS)).

## ■ Output hysteresis

The ratio of the difference (D2) in the no-load output voltages when the pressure is varied from no load to the rated pressure then reduced back to no load, with respect to the full scale voltage (FS).

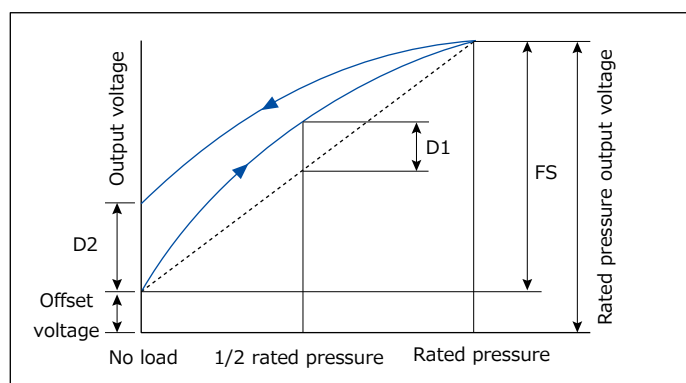

## ■ Offset voltage temperature characteristic

The variation of the offset voltage with changes in ambient temperature. The difference between the offset voltage at the standard temperature and the offset values at the compensation lower limit temperature (low temperature) (D1) and compensation upper limit temperature (high temperature) (D2) are obtained, and the offset voltage temperature characteristic is expressed as the ratio of the larger of these two differences (absolute) with respect to the full scale voltage (FS).

**EXPLANATION OF TERMS**

■ **Temperature sensitivity characteristic**

The variation of the sensitivity with changes in ambient temperature (variation in full scale (FS)). The difference between the full scale voltage at the standard temperature (FS) and the full scale values at the compensation lower limit temperature (low temperature) (FS1) and compensation upper limit temperature (high temperature) (FS2) are obtained, and the offset voltage temperature characteristic is expressed as the ratio of the larger of these two differences (FS1 - FS and FS2 - FS (absolute)) with respect to the full scale voltage (FS).

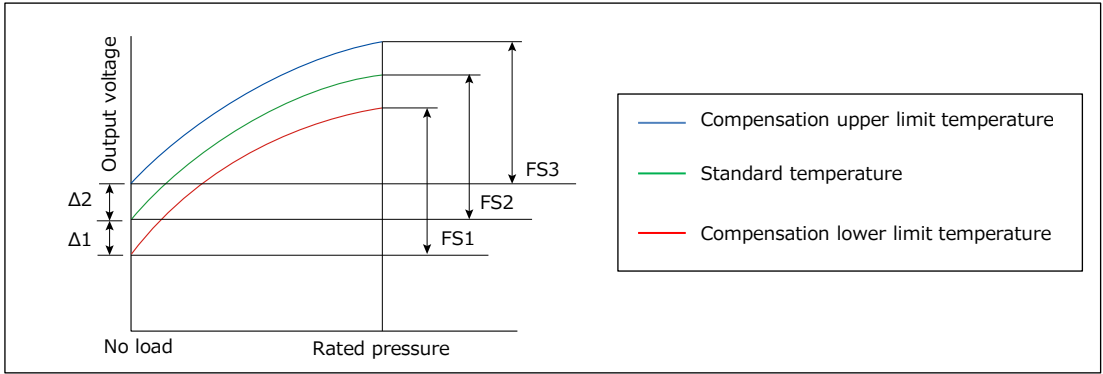

■ **Bridge resistance**

Refers to the resistance value of a piezo resistance formed on a monolithic silicon substrate. For example, the values of the resistances R1 to R4 in the bridge are typically 5 k $\Omega$  each.

\* When the resistances of the resistive elements R1 to R4 that comprise the bridge are 5 k $\Omega$  each, the equivalent composite resistance of the bridge is 5k $\Omega$  (3 k $\Omega$  bridges are also available).

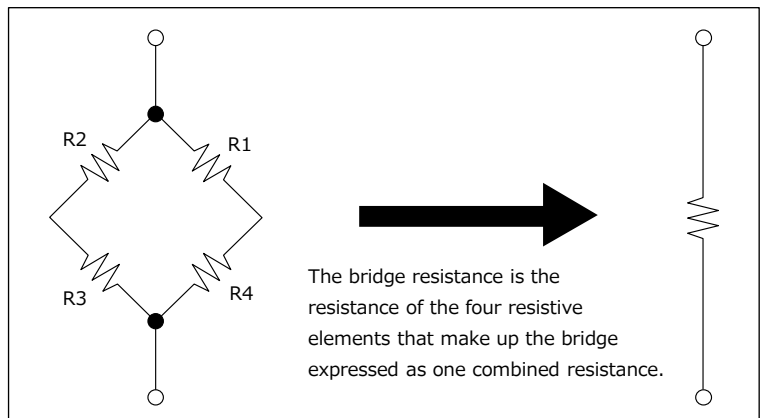

■ **Overall accuracy**

Accuracy of offset voltage and rated pressure output voltage within the temperature compensation range.

## CAUTION AND WARNING

1. The electronic components contained in this catalog are designed and produced for use in home electric appliances, office equipment, information equipment, communications equipment, and other general purpose electronic devices. Before use of any of these components for equipment that requires a high degree of safety, such as medical instruments, aerospace equipment, disaster-prevention equipment, security equipment, vehicles (automobile, train, vessel), please be sure to contact our sales representative corporation.
2. When applying one of these components for equipment requiring a high degree of safety, no matter what sort of application it might be, be sure to install a protective circuit or redundancy arrangement to enhance the safety of your equipment. In addition, please carry out the safety test on your own responsibility.
3. When using our products, no matter what sort of equipment they might be used for, be sure to make a written agreement on the specifications with us in advance.
4. Technical information contained in this catalog is intended to convey examples of typical performances and or applications and is not intended to make any warranty with respect to the intellectual property rights or any other related rights of our company or any third parties nor grant any license under such rights.
5. In order to export products in this catalog, the exporter may be subject to the export license requirement under the Foreign Exchange and Foreign Trade Law of Japan.
6. No ozone-depleting substances (ODSs) under the Montreal Protocol are used in the manufacturing processes of Automotive & Industrial Systems Company, Panasonic Corporation.

● Please contact

● Factory

Device Solutions Business Division  
Industrial Solutions Company

**Panasonic**<sup>®</sup>

1006 Kadoma, Kadoma City, Osaka 571-8506,  
JAPAN

The information in this catalog is valid as of April 2020.