

LT4H Timer

Timers/Time Switches/Counters/Hour Meters



LT4H Timers

UL File No.: E122222
C-UL File No.: E122222

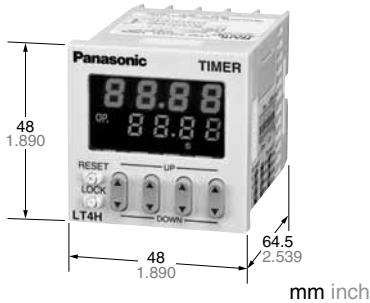

Pin type



Screw terminal type

Features

- Bright and Easy-to-Read Display**
A brand new bright 2-color back light LCD display. The easy-to-read screen in any location makes checking and setting procedures a cinch.
- Simple Operation**
Seesaw buttons make operating the unit even easier than before.
- Short Body of only 64.5 mm 2.539 inch (screw terminal type) or 70.1 mm 2.760 inch (pin type)**
With a short body, it is easy to install in even narrow control panels.
- Conforms to IP66's Weather Resistant Standards**
The water-proof panel keeps out water and dirt for reliable operation even in poor environments.

- Screw terminal (M3.5) and Pin Types are Both Standard Options**
The two terminal types are standard options to support either front panel installation or embedded installation.
- Changeable Panel Cover**
Also offers a black panel cover to meet your design considerations.
- Compliant with UL, c-UL and CE.**

RoHS Directive compatibility information
<http://www.nais-e.com/>

Product types

Time range	Operating mode	Output	Operating voltage	Power down insurance	Terminal type	Part number
9.999 s (0.001 s~) 99.99 s (0.01 s~) 999.9 s (0.1 s~) 9999 s (1 s~) 99 min 59 s (1 s~) 999.9 min (0.1 min~) 99 h 59 min (1 min~) 999.9 h (0.1 h~)	Power ON delay (1) Power ON delay (2) Signal ON delay Signal OFF delay Pulse One-shot Pulse ON-delay Signal Flicker Totalizing ON-delay (8 modes)	Relay (1 c)	100 to 240 V AC	Available	8 pins	LT4H8-AC240V
			24 V AC		11 pins	LT4H-AC240V
					Screw terminal	LT4H-AC240VS
			12 to 24 V DC		8 pins	LT4H8-AC24V
					11 pins	LT4H-AC24V
			Screw terminal		LT4H-AC24VS	
		Transistor (1 a)	100 to 240 V AC		8 pins	LT4HT8-AC240V
			24 V AC		11 pins	LT4HT-AC240V
					Screw terminal	LT4HT-AC240VS
			12 to 24 V DC		8 pins	LT4HT8-AC24V
					11 pins	LT4HT-AC24V
			Screw terminal		LT4HT-AC24VS	

* A rubber gasket (ATC18002) and a mounting frame (AT8-DA4) are included.

LT4H-L Timers

UL File No.: E122222
C-UL File No.: E122222



Features

- Economically priced in anticipation of market needs.**
 - Economically priced to provide excellent cost performance.
- Display is a bright reflective-type LCD.**
- Inherits all of the characteristics of the LT4H digital timer.**
 - Seesaw switches ensure easy operation.
 - IP66 environmental protection.
 - Shortened body (70.1 mm 2.760 inch underhead).

4. Compliant with UL, c-UL and CE.

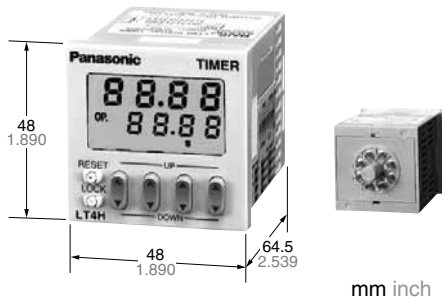

Product types

Product name	Time range	Operating mode	Output	Operating voltage	Power down insurance	Terminal type	Part number
LT4H-L digital timer	9.999 s (0.001 s~) 99.99 s (0.01 s~) 999.9 s (0.1 s~) 9999 s (1 s~) 99 min 59 s (1 s~) 999.9 min (0.1 min~) 99 h 59 min (1 min~) 999.9 h (0.1 h~)	Power ON delay (1) Power ON delay (2) Signal ON delay Signal OFF delay Pulse One-shot Pulse ON-delay Signal Flicker Totalizing ON-delay (8 modes)	Relay (1 c)	100 to 240 V AC	Available	8 pins	LT4HL8-AC240V
				24 V AC/DC			LT4HL8-AC24V
				12 to 24 V DC			LT4HL8-DC24V
			Transistor (1 a)	100 to 240 V AC			LT4HLT8-AC240V
				24 V AC/DC			LT4HLT8-AC24V
				12 to 24 V DC			LT4HLT8-DC24V

Part names

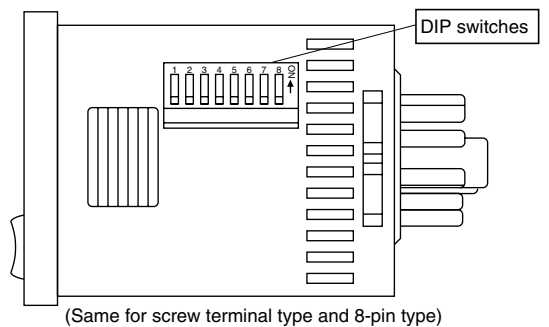
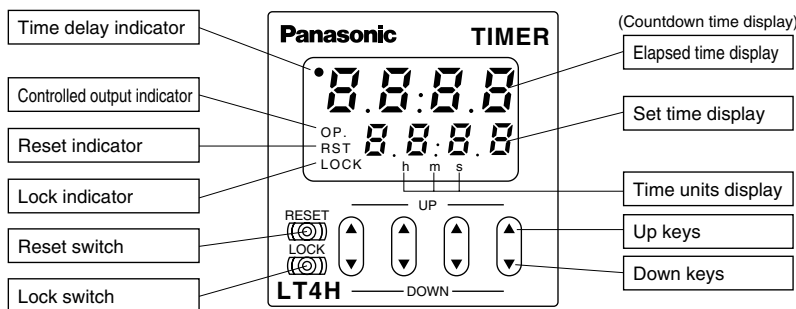

Specifications

Item	Type	Relay output type		Transistor output type	
		AC type AC/DC type	DC type	AC type AC/DC type	DC type
Rating	Rated operating voltage	100 to 240 V AC, 24 V AC, 24 V AC/DC	12 to 24 V DC	100 to 240 V AC, 24 V AC, 24 V AC/DC	12 to 24 V DC
	Rated frequency	50/60 Hz common	—	50/60 Hz common	—
	Rated power consumption	Max. 10 V A	Max. 3 W	Max. 10 V A	Max. 3 W
	Rated control capacity	5 A, 250 V AC (resistive load)		100 mA, 30 V DC	
	Time range	9.999 s, 99.99 s, 999.9 s, 9999 s, 99 min 59 s, 999.9 min, 99 h 59 min, 999.9 h (selected by DIP switch)			
	Time counting direction	Addition (UP)/Subtraction (DOWN) (2 directions selectable by DIP switch)			
	Operation mode	A (Power ON delay 1), A2 (Power ON delay 2), B (Signal ON delay), C (Signal OFF delay), D (Pulse one-shot), E (Pulse ON delay), F (Signal Flicker), G (Totalizing ON delay) (selectable by DIP switch)			
	Start/Reset/Stop input	Min. input signal width: 1 ms, 20 ms (2 directions by selected by DIP switch) (The 8-pin type does not have a stop input.)			
	Lock input	Min. input signal width: 20 ms (The 8-pin type does not have a lock input.)			
	Input signal	Open collector input Input impedance: Max. 1 kΩ; Residual voltage: Max. 2 V Open impedance: 100kΩ or less, Max. energized voltage: 40V DC			
	Indication	7-segment LCD (LT4H, LT4H-L common), Elapsed value (backlight red LED), Setting value (backlight yellow LED)			
Power failure memory method	EEP-ROM (Min. 10 ⁵ overwriting)				
Time accuracy (max.)	Operating time fluctuation	± (0.005 % + 50 ms) in case of power on start ± (0.005 % + 20 ms) in case of input signal start		<div style="border: 1px solid black; padding: 5px; display: inline-block;"> Operating voltage: 85 to 110% Temperature: -10 to +55°C +14 to +131°F Min. input signal width: 1ms </div>	
	Temperature error				
	Voltage error				
	Setting error				
Contact	Contact arrangement	Timed-out 1 Form C		Timed-out 1 Form A (Open collector)	
	Contact resistance (Initial value)	100 mΩ (at 1 A 6 V DC)		—	
	Contact material	Ag alloy/Au flash		—	
Life	Mechanical (contact)	Min. 2 × 10 ⁷ ope. (Except for switch operation parts)		—	
	Electrical (contact)	1.0 × 10 ⁵ ope. (At rated control voltage)		Min. 10 ⁷ ope. (At rated control voltage)	
Electrical	Allowable operating voltage range	85 to 110 % of rated operating voltage			
	Breakdown voltage (Initial value)	2,000 Vrms for 1 min: Between live and dead metal parts (11-pin) 2,000 Vrms for 1 min: Between input and output 1,000 Vrms for 1 min: Between contacts		2,000 Vrms for 1 min: Between live and dead metal parts (Pin type) 2,000 Vrms for 1 min: Between input and output	
	Insulation resistance (Initial value)	Between live and dead metal parts Min. 100 MΩ: Between input and output (At 500V DC) Between contacts		Min. 100 MΩ: Between live and dead metal parts Between input and output (At 500V DC)	
	Operating voltage reset time	Max. 0.5 s			
	Temperature rise	Max. 65° C (under the flow of nominal operating current at nominal voltage)		—	
Mechanical	Vibration resistance	Functional	10 to 55 Hz: 1 cycle/min single amplitude of 0.35 mm .014 inch (10 min on 3 axes)		
		Destructive	10 to 55 Hz: 1 cycle/min single amplitude of 0.75 mm .030 inch (1 h on 3 axes)		
	Shock resistance	Functional	Min. 98 m 321.522 ft./s ² (4 times on 3 axes)		
		Destructive	Min. 294 m 964.567 ft./s ² (5 times on 3 axes)		
Operating conditions	Ambient temperature	-10° C to 55° C +14° F to +131° F			
	Ambient humidity	Max. 85 % RH (non-condensing)			
	Air pressure	860 to 1,060 h Pa			
	Ripple rate	—	20 % or less	—	20 % or less
Connection	8-pin/11-pin/screw terminal				
Protective construction	IP66 (front panel with rubber gasket)				

Applicable standard

Safety standard	EN61812-1	Pollution Degree 2/Overvoltage Category II
EMC	(EMI)EN61000-6-4 Radiation interference electric field strength	EN55011 Group1 ClassA EN55011 Group1 ClassA
	Noise terminal voltage (EMS)EN61000-6-2 Static discharge immunity	EN61000-4-2 4 kV contact 8 kV air
	RF electromagnetic field immunity	EN61000-4-3 10 V/m AM modulation (80 MHz to 1 GHz) 10 V/m pulse modulation (895 MHz to 905 MHz)
	EFT/B immunity	EN61000-4-4 2 kV (power supply line) 1 kV (signal line)
	Surge immunity	EN61000-4-5 1 kV (power line)
	Conductivity noise immunity	EN61000-4-6 10 V/m AM modulation (0.15 MHz to 80 MHz)
	Power frequency magnetic field immunity	EN61000-4-8 30 A/m (50 Hz)
	Voltage dip/Instantaneous stop/Voltage fluctuation immunity	EN61000-4-11 10 ms, 30% (rated voltage) 100 ms, 60% (rated voltage) 1,000 ms, 60% (rated voltage) 5,000 ms, 95% (rated voltage)

Dimensions

• LT4H digital timer

(units: mm inch)
Tolerance: ±1.0 ±.039

Screw terminal type
(Flush mount)

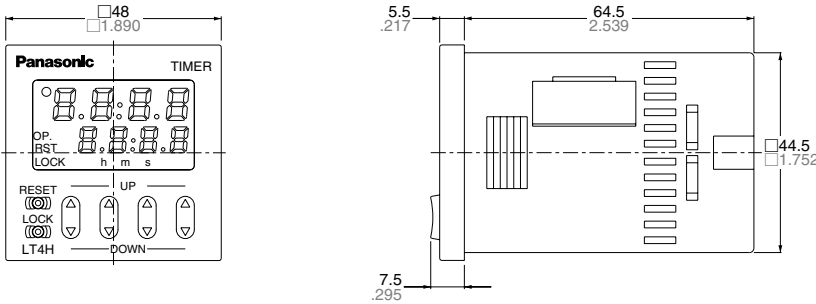

Pin type
(Flush mount/Surface mount)

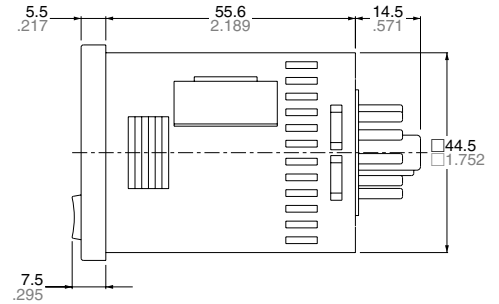

• Dimensions for embedded installation (with adapter installed)

Screw terminal type

Pin type

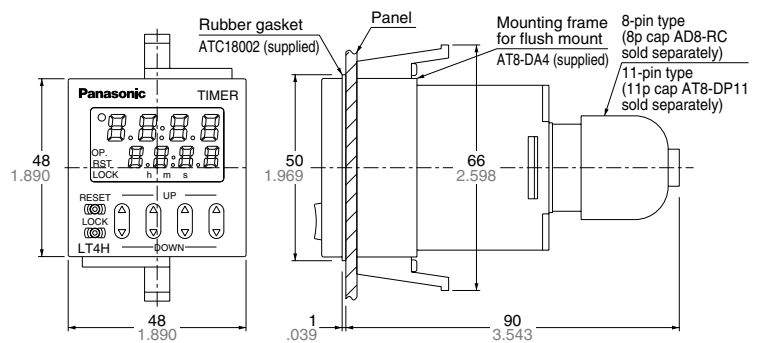
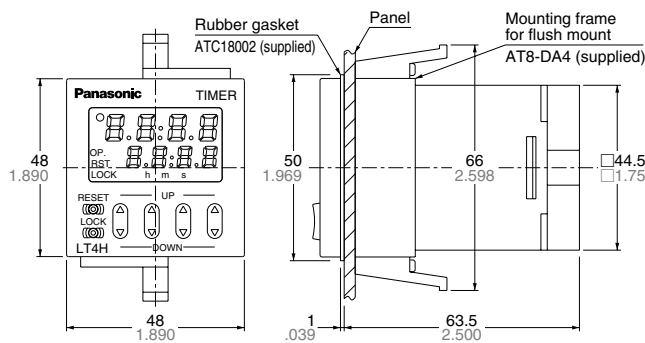

• Dimensions for front panel installations

• Installation panel cut-out dimensions

• For connected installations

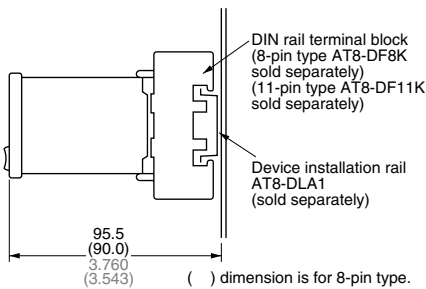

The standard panel cut-out dimensions are shown below. Use the mounting frame (AT8-DA4) and rubber gasket (ATC18002).

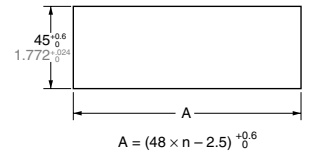
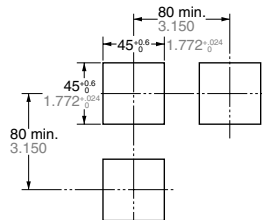

Note) 1: The installation panel thickness should be between 1 and 5 mm (.039 and .197 inch).
2: For connected installations, the waterproofing ability between the unit and installation panel is lost.

Terminal layouts and Wiring diagrams

• 8-pin type

Relay output type

Transistor output type

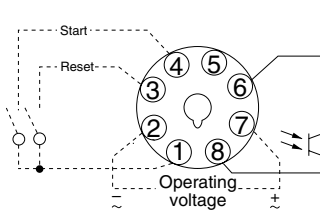
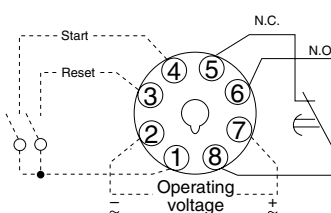

• 11-pin type

Relay output type

Transistor output type

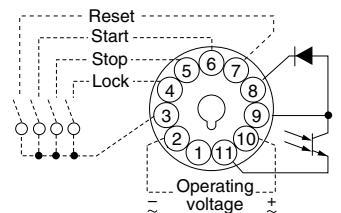
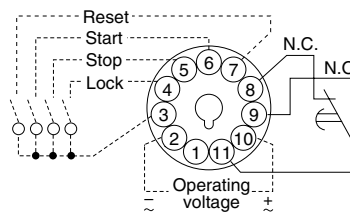

• Screw terminal type

Relay output type

Transistor output type

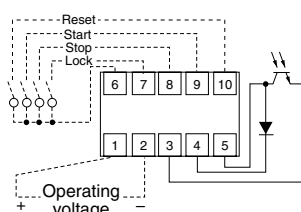
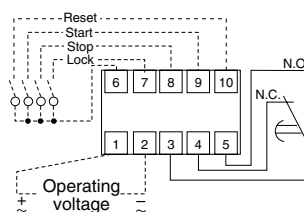

Note) For connecting the output leads of the transistor output type, refer to 5) Transistor output on page 48.

Setting the operation mode, time range, and time

Setting procedure 1) Setting the operation mode and time range

Set the operation mode and time range with the DIP switches on the side of the LT4H timer.

DIP switches

	Item	DIP switch	
		OFF	ON
1	Operation mode	Refer to table 1	
2			
3			
*4	Minimum input reset, start, and stop signal width	20 ms	1 ms
5	Time delay direction	Addition	Subtraction
6	Time range	Refer to table 2	
7			
8			

* The 8-pin type does not have the stop input, so that the dip switch can be changed over between reset and start inputs. The signal range of the lock input is fixed (minimum 20 ms).

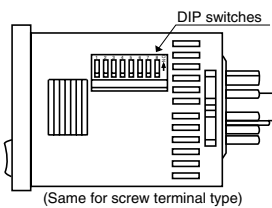

Table 1: Setting the operation mode

DIP switch No.			Operation mode
1	2	3	
ON	ON	ON	A: Power on delay 1
OFF	OFF	OFF	A2: Power on delay 2
ON	OFF	OFF	B: Signal on delay
OFF	ON	OFF	C: Signal off delay
ON	ON	OFF	D: Pulse One shot
OFF	OFF	ON	E: Pulse On delay
ON	OFF	ON	F: Signal Flicker
OFF	ON	ON	G: Totalizing On delay

Table 2: Setting the time range

DIP switch No.			Time range
6	7	8	
ON	ON	ON	0.001 s to 9.999 s
OFF	OFF	OFF	0.01 s to 99.99 s
ON	OFF	OFF	0.1 s to 999.9 s
OFF	ON	OFF	1 s to 9999 s
ON	ON	OFF	0 min 01 s to 99 min 59 s
OFF	OFF	ON	0.1 min to 999.9 min
ON	OFF	ON	0 h 01 min to 99 h 59 min
OFF	ON	ON	0.1 h to 999.9 h

- Notes: 1) Set the DIP switches before installing the timer.
 2) When the DIP SW setting is changed, turn off the power once.
 3) The DIP switches are set as ON before shipping.

Setting procedure 2) Setting the time

Set the set time with the keys (UP and DOWN keys) on the front of the LT4H timer.

Front display section

- ① Elapsed time display
- ② Set time display
- ③ Time delay indicator
- ④ Controlled output indicator
- ⑤ Reset indicator
- ⑥ Lock indicator
- ⑦ Time units display

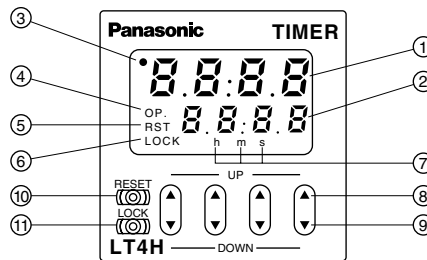

- ⑧ UP keys
Changes the corresponding digit of the set time in the addition direction (upwards)
- ⑨ DOWN keys
Changes the corresponding digit of the set time in the subtraction direction (downwards)
- ⑩ RESET switch
Resets the elapsed time and the output
- ⑪ LOCK switch
Locks the operation of all keys on the unit

• Changing the set time

1. It is possible to change the set time with the up and down keys even during time delay with the timer.

However, be aware of the following points.

1) If the set time is changed to less than the elapsed time with the time delay set to the addition direction, time delay will continue until the elapsed time reaches full scale, returns to zero, and then reaches the new set time. If the set time

is changed to a time above the elapsed time, the time delay will continue until the elapsed time reaches the new set time.

2) If the time delay is set to the subtraction direction, time delay will continue until "0" regardless of the new set time.

2. If the set time is changed to "0," the unit will operate differently depending on the operation mode.

1) If the operation mode is set to A (power on delay 1) or A2 (power on

delay 2), the output will turn on when the power supply is turned on. However, the output will be off while reset is being input.

2) In the other modes, the output turns on when the start is input. When the operation mode is C (signal off delay), D (Pulse one shot), or F (Signal flicker), only when the start input is on does the output turn on. Also, when the reset is being input, the output is off.

• Power failure memory

The EEPROM is used for power failure memory. It has a life of Min. 10⁵ over-writings.

The EEPROM is overwriting with the following timing.

Output mode	Overwrite timing
Power ON delay (2) A2	When power is OFF
Addition G	Change of preset value or start, reset input When power is OFF after being ON
Other modes	When power is OFF after changing preset value

* Be aware that the contents of EEPROM for all modes will be overwritten when power is turned OFF during input to external lock terminals ④ to ③ and ⑦ to ⑥. Such an action does not exist by doing lock operation from the front.

Operation mode

Operation type	Explanation	Time chart						
Power on delay (1) (A)	<ul style="list-style-type: none"> Set the operation mode section of the DIP switches (no.'s 1, 2, and 3) on the side of the timer as shown. <table border="1" style="margin-left: 20px;"> <tr> <td>1</td> <td>2</td> <td>3</td> </tr> <tr> <td>ON</td> <td>ON</td> <td>ON</td> </tr> </table> Clears elapsed time value and starts time delay at power ON. After timer completion, stops at the display of the set value (addition), or stops at "0" (subtraction). Ignores start input. Stops delay time operation at stop ON. Restarts delay time operation at stop OFF. 	1	2	3	ON	ON	ON	
1	2	3						
ON	ON	ON						
Power on delay (2) (A2)	<ul style="list-style-type: none"> Set the operation mode section of the DIP switches (no.'s 1, 2, and 3) on the side of the timer as shown. <table border="1" style="margin-left: 20px;"> <tr> <td>1</td> <td>2</td> <td>3</td> </tr> <tr> <td>OFF</td> <td>OFF</td> <td>OFF</td> </tr> </table> Elapsed time value does not clear at power ON. (power outage countermeasure function) The output remains ON even after the power is cut and restarted. After timer completion, stops at the display of the set value (addition), or stops at "0" (subtraction). Ignores start input. Stops delay time operation at stop ON. Restarts delay time operation at stop OFF. 	1	2	3	OFF	OFF	OFF	
1	2	3						
OFF	OFF	OFF						
Signal on delay (B)	<ul style="list-style-type: none"> Set the operation mode section of the DIP switches (no.'s 1, 2, and 3) on the side of the timer as shown. <table border="1" style="margin-left: 20px;"> <tr> <td>1</td> <td>2</td> <td>3</td> </tr> <tr> <td>ON</td> <td>OFF</td> <td>OFF</td> </tr> </table> Clears elapsed time value at power ON. Time delay starts at start ON and elapsed time value or output resets at start OFF. Instantaneous time delay start at reset OFF and power ON while start is ON. Stops delay time operation at stop ON. Restarts delay time operation at stop OFF. In order to have the time delay start at power ON or reset at power OFF, short out the start input beforehand. 	1	2	3	ON	OFF	OFF	
1	2	3						
ON	OFF	OFF						
Signal off delay (C)	<ul style="list-style-type: none"> Set the operation mode section of the DIP switches (no.'s 1, 2, and 3) on the side of the timer as shown. <table border="1" style="margin-left: 20px;"> <tr> <td>1</td> <td>2</td> <td>3</td> </tr> <tr> <td>OFF</td> <td>ON</td> <td>OFF</td> </tr> </table> Clears elapsed time value at power ON. Output control ON at start ON and time delay start at start OFF. Elapsed time value clears when start goes ON again during time delay. Stops delay time operation at stop ON. Restarts delay time operation at stop OFF. 	1	2	3	OFF	ON	OFF	
1	2	3						
OFF	ON	OFF						

Notes: 1) Each signal input (start, reset, stop, and lock) is applied by shorting their input terminal to the common terminal (terminal ① for the 8-pin type, terminal ③ for the 11-pin type, and terminal ⑥ for the screw terminal type).
 2) The 8-pin type does not have a stop input or lock input.

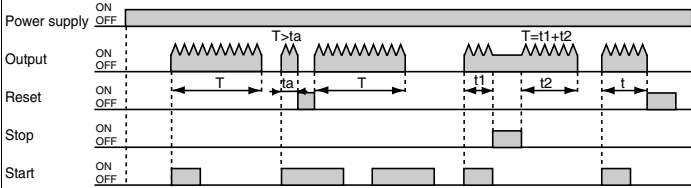
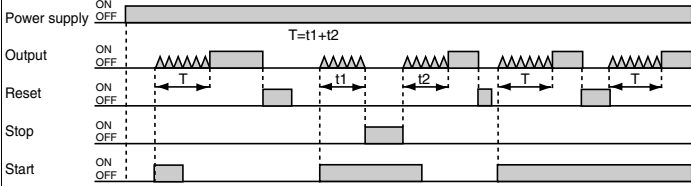
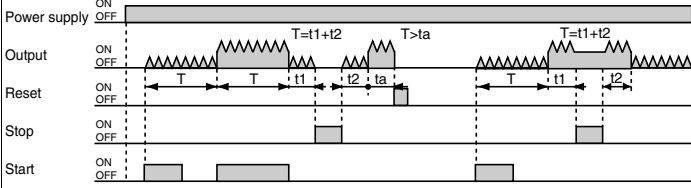
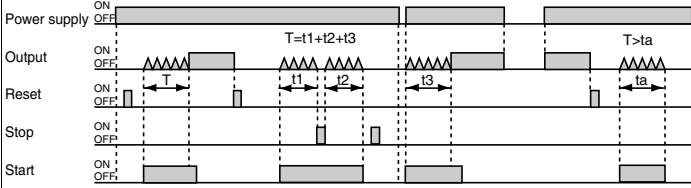
Operation type	Explanation	Time chart						
<p>Pulse One-shot Ⓓ</p>	<ul style="list-style-type: none"> Set the operation mode section of the DIP switches (no.'s 1, 2, and 3) on the side of the timer as shown. <table border="1" data-bbox="564 248 746 309"> <tr> <td>1</td> <td>2</td> <td>3</td> </tr> <tr> <td>ON</td> <td>ON</td> <td>OFF</td> </tr> </table> Clears elapsed time value at power ON. Time delay starts and output control ON at start ON. Turns output control OFF and clears elapsed time value at time-up. Ignores start input during time delay. Stops delay time operation at stop ON. Restarts delay time operation at stop OFF. In order to have the time delay start at power ON or reset at power OFF, short out the start input beforehand. 	1	2	3	ON	ON	OFF	
1	2	3						
ON	ON	OFF						
<p>Pulse On delay Ⓔ</p>	<ul style="list-style-type: none"> Set the operation mode section of the DIP switches (no.'s 1, 2, and 3) on the side of the timer as shown. <table border="1" data-bbox="564 714 746 775"> <tr> <td>1</td> <td>2</td> <td>3</td> </tr> <tr> <td>OFF</td> <td>OFF</td> <td>ON</td> </tr> </table> Clears elapsed time value at power ON. Time delay starts at start ON. Ignores start input during time delay. Stops delay time operation at stop ON. Restarts delay time operation at stop OFF. In order to have the time delay start at power ON or reset at power OFF, short out the start input beforehand. 	1	2	3	OFF	OFF	ON	
1	2	3						
OFF	OFF	ON						
<p>Signal Flicker Ⓕ</p>	<ul style="list-style-type: none"> Set the operation mode section of the DIP switches (no.'s 1, 2, and 3) on the side of the timer as shown. <table border="1" data-bbox="564 1182 746 1243"> <tr> <td>1</td> <td>2</td> <td>3</td> </tr> <tr> <td>ON</td> <td>OFF</td> <td>ON</td> </tr> </table> Clears elapsed time value at power ON. Time delay starts at start ON. Ignores start input during time delay. Output control reverses, elapsed time value clears, and timer delay starts at timer completion. Stops delay time operation at stop ON. Restarts delay time operation at stop OFF. In order to have the time delay start at power ON or reset at power OFF, short out the start input beforehand. 	1	2	3	ON	OFF	ON	
1	2	3						
ON	OFF	ON						
<p>Totalizing On delay Ⓖ</p>	<ul style="list-style-type: none"> Set the operation mode section of the DIP switches (no.'s 1, 2, and 3) on the side of the timer as shown. <table border="1" data-bbox="564 1650 746 1711"> <tr> <td>1</td> <td>2</td> <td>3</td> </tr> <tr> <td>OFF</td> <td>ON</td> <td>ON</td> </tr> </table> Elapsed time value does not clear at power ON. (power outage countermeasure function) The output remains ON even after the power is off and restarted. Stops delay time operation at stop ON. Restarts delay time operation at stop OFF. 	1	2	3	OFF	ON	ON	
1	2	3						
OFF	ON	ON						

Notes: 1) Each signal input (start, reset, stop, and lock) is applied by shorting their input terminal to the common terminal (terminal ① for the 8-pin type, terminal ③ for the 11-pin type, and terminal ⑥ for the screw terminal type).
2) The 8-pin type does not have a stop input or lock input.

**DIN 48 SIZE
DIGITAL TIMER**

**LT4H-W
Timers**

UL File No.: E122222
C-UL File No.: E122222

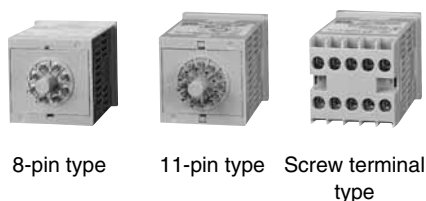
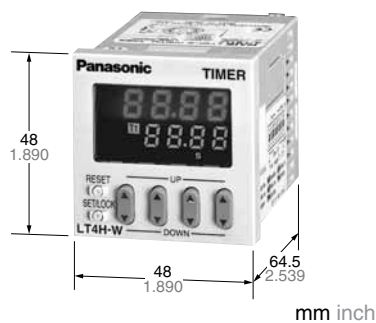

RoHS Directive compatibility information
<http://www.nais-e.com/>

Features

- 1. Wide time range**
The operation time range covers from 0.01 sec. to 9999 hours. The individual setting can be performed on each of 1 and 2 timers.
99.99s 99min59s 99h59min
999.9s 999.9min 999.9h
9999s 9999h
- 2. Bright and Easy-to-Read Display**
A brand new bright 2-color back light LCD display. The easy-to-read screen in any location makes checking and setting procedures a cinch.
- 3. Simple Operation**
Seesaw buttons make operating the unit even easier than before.
- 4. Short Body of only 64.5 mm 2.539 inch (screw terminal type) or 70.1 mm 2.760 inch (pin type)**
With a short body, it is easy to install in even narrow control panels.

- 5. Conforms to IP66's Weather Resistant Standards**
The water-proof panel keeps out water and dirt for reliable operation even in poor environments.
- 6. Screw terminal (M3.5) and Pin Types are Both Standard Options**
The two terminal types are standard options to support either front panel installation or embedded installation.
- 7. Changeable Panel Cover**
Also offers a black panel cover to meet your design considerations.
- 8. Compliant with UL, c-UL and CE.**
- 9. Low Price**
All this at an affordable price to provide you with unmatched cost performance.

Product types

Time range	Operating mode	Output	Operating voltage	Power down insurance	Terminal type	Part number	
99.99s 999.9s 9999s 99min59s 999.9min 99h59min 999.9h 9999h	Pulse input: • Delayed one shot • OFF-start flicker • ON-start flicker Integrating input: • Delayed one shot • OFF-start flicker • ON-start flicker	Relay (1 c)	100 to 240 V AC	Available	8 pins	LT4HW8-AC240V	
					11 pins	LT4HW-AC240V	
					Screw terminal	LT4HW-AC240VS	
					24 V AC	8 pins	LT4HW8-AC24V
					11 pins	LT4HW-AC24V	
					Screw terminal	LT4HW-AC24VS	
		12 to 24 V DC	8 pins		LT4HW8-DC24V		
		11 pins	LT4HW-DC24V				
		Screw terminal	LT4HW-DC24VS				
		Transistor (1 a)	100 to 240 V AC		8 pins	LT4HWT8-AC240V	
			11 pins		LT4HWT-AC240V		
			Screw terminal		LT4HWT-AC240VS		
	24 V AC		8 pins	LT4HWT8-AC24V			
	11 pins		LT4HWT-AC24V				
	Screw terminal		LT4HWT-AC24VS				
	12 to 24 V DC	8 pins	LT4HWT8-DC24V				
	11 pins	LT4HWT-DC24V					
	Screw terminal	LT4HWT-DC24VS					

* A rubber gasket (ATC18002) and a mounting frame (AT8-DA4) are included.

LT4H-W

Part names

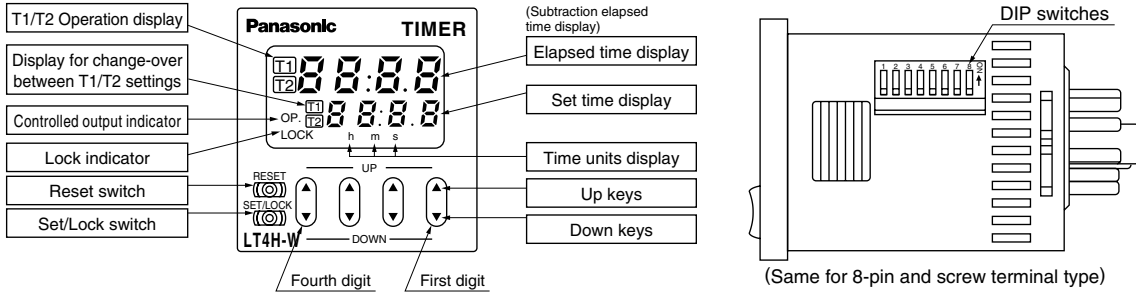

Specifications

Item	Type	Relay output type		Transistor output type	
		AC type	DC type	AC type	DC type
Rating	Rated operating voltage	100 to 240 V AC, 24 V AC	12 to 24 V DC	100 to 240V AC, 24V AC	12 to 24 V DC
	Rated frequency	50/60 Hz common	—	50/60 Hz common	—
	Rated power consumption	Max. 10 V A	Max. 3 W	Max. 10 V A	Max. 3 W
	Rated control capacity	5 A, 250 V AC		100 mA, 30 V DC	
	Time range	99.99s, 999.9s, 9999s, 99min59s, 999.9min, 99h59min, 999.9h, 9999h (selected by DIP switch)			
	Time counting direction	Addition (UP)/Subtraction (DOWN) (2 directions selectable by DIP switch)			
	Operation mode	Pulse input: Delayed one shot, OFF-start flicker or ON-start flicker Integrating input: Delayed one shot, OFF-start flicker or ON-start flicker			
	Start/Reset/Stop input	Min. input signal width: 1 ms, 20 ms (2 directions by selected by DIP switch) (The 8 pin type does not have a stop input.)			
	Lock input	Min. input signal width: 20 ms (The 8-pin type does not have a lock input.)			
	Input signal	Open collector input Input impedance: Max. 1 kΩ; Residual voltage: Max. 2V Open impedance: 100 kΩ or less, Max. energized voltage: 40 V DC			
Indication	7-segment LCD, Elapsed value (backlight red LED), Setting value (backlight yellow LED)				
Power failure memory method	EEP-ROM (Min. 10 ⁵ overwriting)				
Time accuracy (max.)	Operating time fluctuation	<div style="border: 1px solid black; padding: 5px; display: inline-block;"> [Operating voltage: 85% to 110% Temperature: -10°C to +55°C +14°F to +131°F Min. input signal width: 1ms] </div>			
	Temperature error				
	Voltage error				
	Setting error				
Contact	Contact arrangement	Timed-out 1 Form C		Timed-out 1 Form A (Open collector)	
	Contact resistance (Initial value)	100 mΩ (at 1 A 6 V DC)		—	
	Contact material	Ag alloy/Au flash		—	
Life	Mechanical (contact)	Min. 2 × 10 ⁷ ope. (Except for switch operation parts)		—	
	Electrical (contact)	Min. 10 ⁶ ope. (At rated control voltage)		Min. 10 ⁷ ope. (At rated control voltage)	
Electrical	Allowable operating voltage range	85 to 110 % of rated operating voltage			
	Breakdown voltage (Initial value)	2,000 Vrms for 1 min: Between live and dead metal parts (11-pin type only) 2,000 Vrms for 1 min: Between input and output 1,000 Vrms for 1 min: Between contacts		2,000 Vrms for 1 min: Between live and dead metal parts (Pin type only) 2,000 Vrms for 1 min: Between input and output	
	Insulation resistance (Initial value)	Min. 100 MΩ: Between live and dead metal parts Between input and output (At 500V DC) Between contacts		Min. 100 MΩ: Between live and dead metal parts Between input and output (At 500V DC)	
	Operating voltage reset time	Max. 0.5 s			
	Temperature rise	Max 65° C (under the flow of nominal operating current at nominal voltage)		—	
Mechanical	Vibration resistance	Functional	10 to 55 Hz: 1 cycle/ min single amplitude of 0.35 mm .014 inch (10 min on 3 axes)		
		Destructive	10 to 55 Hz: 1 cycle/ min single amplitude of 0.75 mm .030 inch (1 h on 3 axes)		
	Shock resistance	Functional	Min. 98 m 321.522 ft./s ² (4 times on 3 axes)		
		Destructive	Min. 294 m 964.567 ft./s ² (5 times on 3 axes)		
Operating conditions	Ambient temperature	-10° C to 55° C +14° F to +131° F			
	Ambient humidity	Max. 85 % RH (non-condensing)			
	Air pressure	860 to 1,060 h Pa			
	Ripple rate	—	20 % or less	—	20 % or less
Connection	8-pin/11-pin/screw terminal				
Protective construction	IP66 (front panel with rubber gasket)				

Applicable standard

Safety standard	EN61812-1	Pollution Degree 2/Overvoltage Category II
EMC	(EMI)EN61000-6-4 Radiation interference electric field strength Noise terminal voltage (EMS)EN61000-6-2 Static discharge immunity	EN55011 Group1 ClassA EN55011 Group1 ClassA
	RF electromagnetic field immunity	EN61000-4-2 4 kV contact 8 kV air
EMC	EFT/B immunity	EN61000-4-3 10 V/m AM modulation (80 MHz to 1 GHz) 10 V/m pulse modulation (895 MHz to 905 MHz)
	Surge immunity Conductivity noise immunity Power frequency magnetic field immunity Voltage dip/Instantaneous stop/Voltage fluctuation immunity	EN61000-4-4 2 kV (power supply line) 1 kV (signal line) EN61000-4-5 1 kV (power line) EN61000-4-6 10 V/m AM modulation (0.15 MHz to 80 MHz) EN61000-4-8 30 A/m (50 Hz) EN61000-4-11 10 ms, 30% (rated voltage) 100 ms, 60% (rated voltage) 1,000 ms, 60% (rated voltage) 5,000 ms, 95% (rated voltage)

Dimensions

(units: mm inch)
Tolerance: ±1.0 ±.039

• LT4H-W digital timer

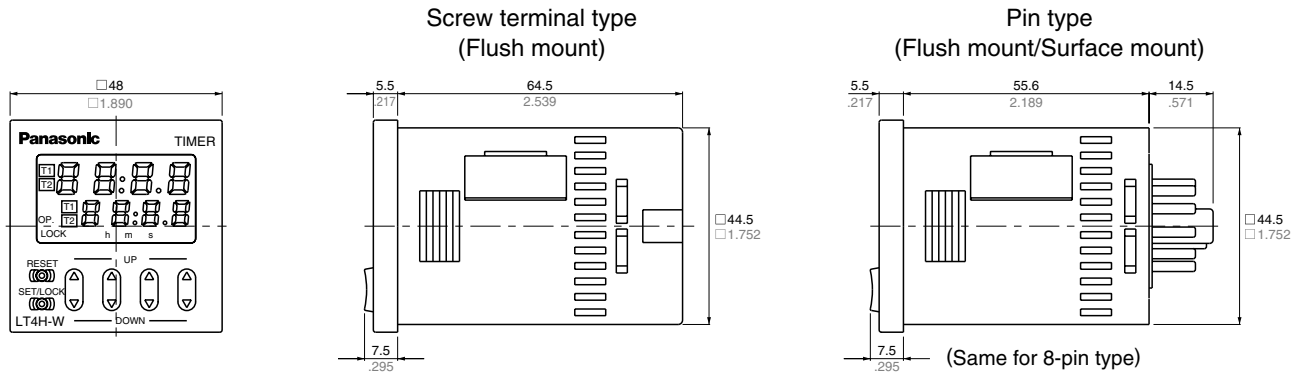

• Dimensions for flush mount (with adapter installed)

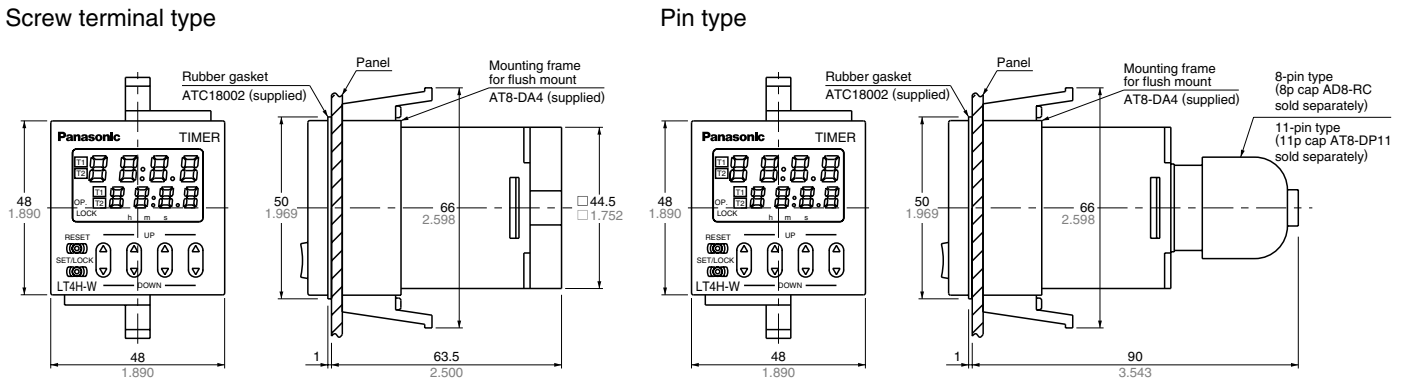

• Dimensions for front panel installations

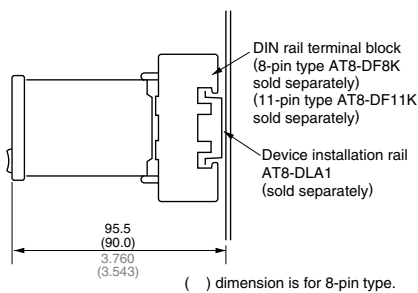

• Installation panel cut-out dimensions

The standard panel cut-out dimensions are shown below. Use the mounting frame (AT8-DA4) and rubber gasket (ATC18002).

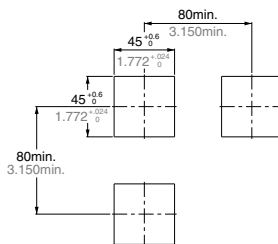

• For connected installations

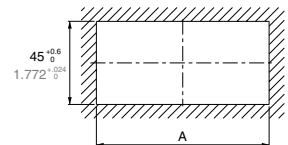

When n timers are continuously installed, the dimension (A) is calculated according to the following formula (n: the number of the timers to be installed):

$$A = (48 \times n - 2.5)^{+0.6}_0 \quad A = (1.890 \times n - .098)^{+0.024}_0$$

- Note) 1: The installation panel thickness should be between 1 and 5 mm .039 and .197 inch.
2: For connected installations, the waterproofing ability between the unit and installation panel is lost.

Terminal layouts and Wiring diagrams

• 8-Pin type

Relay output type

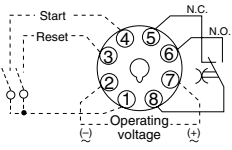

Transistor output type

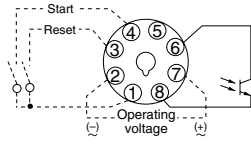

• 11-Pin type

Relay output type

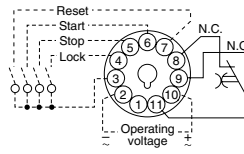

Transistor output type

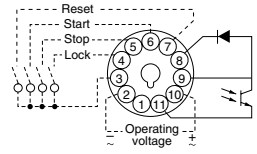

• Screw terminal type

Relay output type

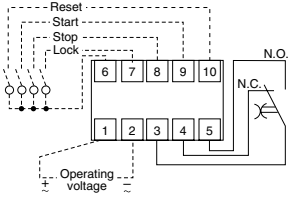

Transistor output type

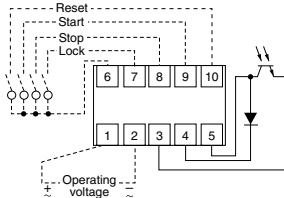

Note) For connecting the output leads of the transistor output type, refer to 5) Transistor output on page 48.

Setting the operation mode and time range

Setting procedure 1) Setting the time range (Timer T₁/Timer T₂)

Set the time range with the DIP switches on the side of the LT4H-W timer.

Item	DIP switch		
	OFF	ON	
1	Refer to table 1		
2			
3			
*4	Minimum input reset, start, and stop signal width	20 ms	1 ms
5	Time delay direction	Addition	Subtraction
6	Refer to table 2		
7			
8			

* The 8-pin type does not have the stop input, so that the dip switch can be changed over between reset and start inputs. The signal range of the lock input is fixed (minimum 20 ms).

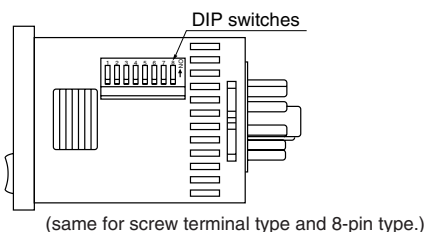

Table 1: Setting the time range (Timer T₁)

DIP switch No.			Time range
1	2	3	
ON	ON	ON	0.01 s to 99.99 s
OFF	OFF	OFF	0.1 s to 999.9 s
ON	OFF	OFF	1 s to 9999 s
OFF	ON	OFF	0 min 01 s to 99 min 59 s
ON	ON	OFF	0.1 min to 999.9 min
OFF	OFF	ON	0 h 01 min to 99 h 59 min
ON	OFF	ON	0.1 h to 999.9 h
OFF	ON	ON	1 h to 9999 h

Table 2: Setting the time range (Timer T₂)

DIP switch No.			Time range
6	7	8	
ON	ON	ON	0.01 s to 99.99 s
OFF	OFF	OFF	0.1 s to 999.9 s
ON	OFF	OFF	1 s to 9999 s
OFF	ON	OFF	0 min 01 s to 99 min 59 s
ON	ON	OFF	0.1 min to 999.9 min
OFF	OFF	ON	0 h 01 min to 99 h 59 min
ON	OFF	ON	0.1 h to 999.9 h
OFF	ON	ON	1 h to 9999 h

- Notes: 1) Set the DIP switches before installing the timer.
 2) When the DIP SW setting is changed, turn off the power once.
 3) The DIP switches are set as ON before shipping.

Setting procedure 2) Setting the operation mode

Set the operation mode with the keys on the front of the LT4H-W timer.

Front display section

- Elapsed time display
- Set time display
- T₁/T₂ operation indicator
- T₁/T₂ setting value selectable indicator
- Controlled output indicator
- Lock indicator
- Time units display

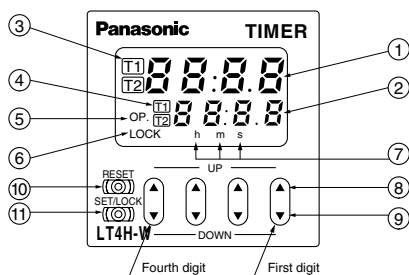

- UP keys
Changes the corresponding digit of the set time in the addition direction (upwards)
- DOWN keys
Changes the corresponding digit of the set time in the subtraction direction (downwards)
- RESET switch
Resets the elapsed time and the output
- SET/LOCK switch
Changes over the display between T₁/T₂ settings, sets the operation mode, checks the operation mode and locks the operation of each key (such as up, down or reset key).

1) Setting or changing the operation mode

- When the UP or DOWN key at the first digit is pressed with the SET/LOCK switch pressed, the mode is changed over to the setting mode.
- Now release the SET/LOCK switch.
- The operation mode in the setting mode is changed over sequentially in the left or right direction by pressing the UP or DOWN key at the first digit, respectively.

Ex: Setting operation mode display (PULSE-A example)

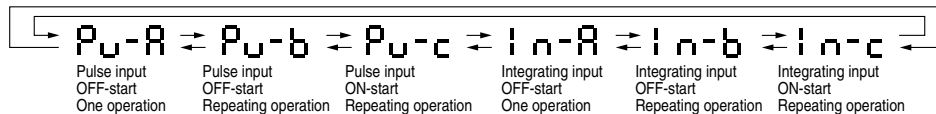
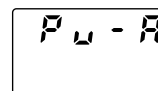

- The operational mode displayed at present is set by pressing the RESET switch, and the display returns to the normal condition.

2) Setting (changing) the time

- Pressing the SET/LOCK key switches the set value display between T₁ and T₂. Display the timer (T₁ or T₂) which is to be set (or changed).
- After displaying the timer (T₁ or T₂) which is to be set, press the UP or DOWN key to change the time.

• Checking the operation mode

When the UP or DOWN key at the second digit is pressed with the SET/LOCK switch pressed, the operational mode can be checked. The display returns to the normal condition after indicating the operational mode for about two seconds. (While the display indicates the operational mode for about two seconds, the other indicators continue to operate normally.)

• Setting the lock

When the UP or DOWN key at the fourth digit is pressed with the SET/LOCK switch pressed, all keys on the unit are locked. The timer does not accept any of UP, DOWN and RESET keys.

To release the lock setting, press the UP or DOWN key at the fourth digit again with the set/lock switch pressed.

* Operational mode, adding and subtracting and minimum input signal range cannot be set at T₁ and T₂, respectively.

• Changing over the T₁/T₂ setting display

The T₁/T₂ setting display is changed over by pressing the SET/LOCK switch. (This operation gives no effect on the other operations. The set time and elapsed time (residual time) at T₁ are linked with those at T₂.)

• Changing the set time

- It is possible to change the set time with the UP and DOWN keys even during time delay with the timer. However, be aware of the following points.
 - If the set time is changed to less than the elapsed time with the time delay set to the addition direction, time delay will continue until the elapsed time reaches full scale, returns to zero, and then reaches the new set time. If the set time is changed to a time above the elapsed time, the time delay will continue until the elapsed time reaches the new set time.
 - If the time delay is set to the subtraction direction, time delay will continue until "0" regardless of the new set time.
- When the set times at T₁ and T₂ are set to 0, the output becomes ON only while the start input is carried out. However, while the reset input is carried out, the output becomes OFF.

OPERATION MODE

	PULSE : Pulse input	INTEGRATION : Integrating input
A Delayed one shot	<p style="text-align: center;">PULSE A OFF-start/1 operation $t_1 < T_1, t_2 < T_2$</p> <p>• Elapsed value cleared when power is turned on. • Time limit start initiated when start input goes on; start input ignored if time limit interval is in progress. • Elapsed value cleared when one operation has been completed.</p>	<p style="text-align: center;">INTEGRATION A OFF-start/1 operation $t_1 < T_1, t_2 < T_2$</p> <p>• Elapsed value not cleared when power is turned on (power failure backup function). • When power is turned back on, same status is maintained for output as that previous to power going off. • Elapsed value cleared when one operation has been completed.</p>
B OFF-start flicker	<p style="text-align: center;">PULSE B OFF-start/repeating operation $t_1 < T_1, t_2 < T_2$</p> <p>• Elapsed value cleared when power is turned on. • Time limit start initiated when start input goes on; start input ignored if time limit interval is in progress.</p>	<p style="text-align: center;">INTEGRATION B OFF-start/repeating operation $t_1 < T_1, t_2 < T_2$</p> <p>• Elapsed value not cleared when power is turned on (power failure backup function). • When power is turned back on, same status is maintained for output as that previous to power going off.</p>
C ON-start flicker	<p style="text-align: center;">PULSE C ON-start/repeating operation $t_1 < T_1, t_2 < T_2$</p> <p>• Elapsed value cleared when power is turned on. • Time limit start initiated when start input goes on; start input ignored if time limit interval is in progress.</p>	<p style="text-align: center;">INTEGRATION C ON-start/repeating operation $t_1 < T_1, t_2 < T_2$</p> <p>• Elapsed value not cleared when power is turned on (power failure backup function). • When power is turned back on, same status is maintained for output as that previous to power going off.</p>
Remarks and notes	<ul style="list-style-type: none"> • The pulse input mode starts the operation by starting the start input. • When using the unit by starting it with the power on, short-circuit the start terminal (8-pin: ① to ④, 11-pin: ③ to ⑥ and screw terminal: ⑥ to ⑨). 	<ul style="list-style-type: none"> • The integrating input mode is operated by the integrated time of the start input. In other word, the timer operates only when the start input is performed. • When the elapsed value is cleared by the reset input, the output is reset. • When using the unit by starting it with the power on, short-circuit the start terminal (8-pin: ① to ④, 11-pin: ③ to ⑥ and screw terminal: ⑥ to ⑨).
	<ul style="list-style-type: none"> • Each signal input such as start, reset, stop and lock inputs is applied by short-circuiting its input terminal and common terminal (8-pin type: terminal ①, 11-pin type: terminal ③ and screw terminal: terminal ⑥) respectively. • The 8-pin type does not have a stop input or lock input. 	

PRECAUTIONS IN USING THE LT4H SERIES

1. Terminal wiring

1) When wiring the terminals, refer to the terminal layout and wiring diagrams and be sure to perform the wiring properly without errors.

2) When using the instrument with an flush mounting, the screw-down terminal type is recommended. For the pin type, use either the rear terminal block (AT78041) or the 8P cap (AD8-RC) for the 8-pin type, and the rear terminal block (AT78051) or the 11P cap (AT8-DP11) for the 11-pin type. Avoid soldering directly to the round pins on the unit. When using the instrument with a front panel installation, use the DIN rail terminal block (AT8-DF8K) for the 8-pin type and the DIN rail terminal block (AT8-DF11K) for the 11-pin type.

3) After turning the unit off, make sure that any resulting induced voltage or residual voltage is not applied to power supply terminals ② through ⑦ (8-pin type) ② through ⑩ (11-pin type) or ① and ② (screw terminal type). (If the power supply wire is wired parallel to the high voltage wire or power wire, an induced voltage may be generated between the power supply terminals.)
4) Have the power supply voltage pass through a switch or relay so that it is applied at one time. If the power supply is applied gradually, the counting may malfunction regardless of the settings, the power supply reset may not function, or other such unpredictable occurrence may result.

2. Input connections

The power circuit has no transformer (power and input terminals are not insulated). When an input signal is fed to two or more timers at once, do not arrange the power circuit in an independent way. If the timer is powered on and off independently as shown in Fig. A, the timer's internal circuitry may get damaged. Be careful never to allow such circuitry. (Figs. A, B and C show the circuitry for the 11-pin type.)

(Fig. A)
Input contact point or transistor

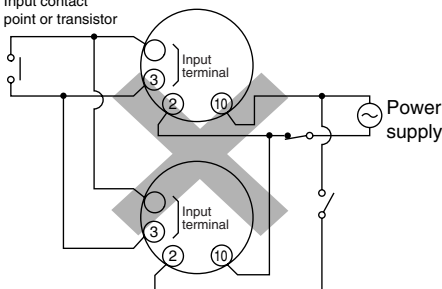

If independent power circuitry must be used, keep the input contacts or transistors separate from each other, as shown in Fig. B.

(Fig. B)

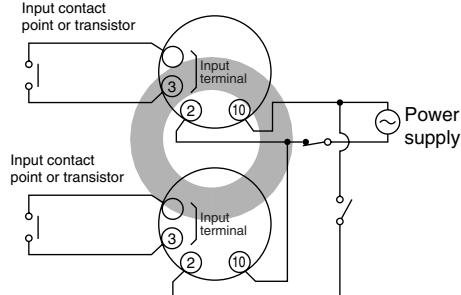

When power circuitry is not independent, one input signal can be fed to two or more counters at once, as shown in Fig. C.

(Fig. C)

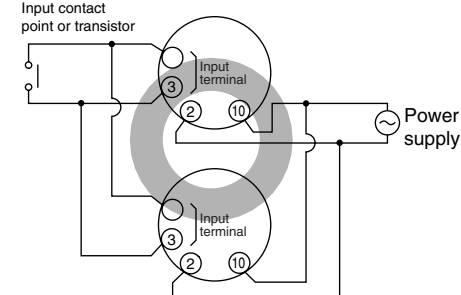

3. Input and output

1) Signal input type

(1) Contact point input

Use highly reliable metal plated contacts. Since the contact point's bounce time leads directly to error in the timer operations, use contacts with as short a bounce time as possible. Also, select a minimum input signal width of 20 ms.

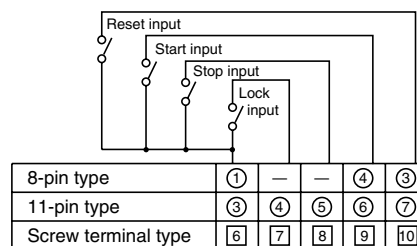

(2) Non-contact point input

Connect with an open collector. Use transistors whose characteristics satisfy the criteria given below.

$$V_{CE0} = 20 \text{ V min.}$$

$$I_C = 20 \text{ mA min.}$$

$$I_{CBO} = 6\mu\text{A max.}$$

Also, use transistors with a residual voltage of less than 2 V when the transistor is on.

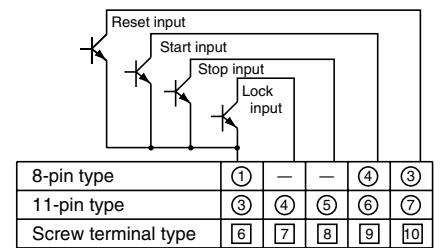

* The short-circuit impedance should be less than 1 k Ω .

[When the impedance is 0 Ω , the current coming from the start input and stop input terminals is approximately 12 mA, and from the reset input and lock input terminals is approximately 1.5 mA.]

Also, the open-circuit impedance should be more than 100 k Ω .

* As shown in the diagram below, from a non-contact point circuit (proximity switches, photoelectric switches, etc.) with a power supply voltage of between 12 and 40 V, the signal can be input without using an open collector transistor. In the case of the diagram below, when the non-contact point transistor Q switches from off to on (when the signal voltage goes from high to low), the signal is input.

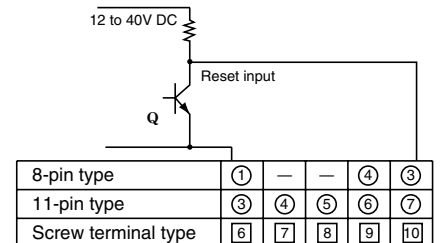

(The above example is for reset input)

2) The input mode and output mode change depending on the DIP switch settings. Therefore, before making any connections, be sure to confirm the operation mode and operation conditions currently set.

3) The LT4H series use power supply without a transformer (power and input terminals are not insulated). In connecting various kinds of input signals, therefore, use a power transformer in which the primary side is separated from the ungrounded secondary side as shown in Fig. A, for the power supply for a sensor and other input devices so that short-circuiting can be prevented.

PRECAUTIONS IN USING THE LT4H SERIES

Once the wiring to be used is completely installed and prior to installing this timer, confirm that there is complete insulation between the wires connected to the power terminals (2 each) and the wires connected to each input terminal. If the power and input lines are not insulated, a short-circuit may occur inside the timer and result in internal damage. In addition, when moving your equipment to a new installation location, confirm that there is no difference in environmental conditions as compared to the previous location.

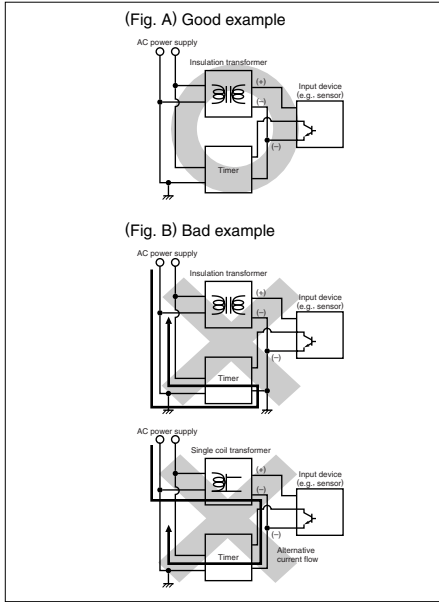

4) The input signal is applied by the shorting of each input terminal with the common terminal (terminal ① for 8-pin types, terminal ③ for 11-pin types and terminal ⑥ for screw terminal types). Never connect other terminals or voltages higher than 40V DC, because it may destroy the internal circuitry.

5) Transistor output

(1) Since the transistor output is insulated from the internal circuitry by a photocoupler, it can be used as an NPN output or PNP (equal value) output. (The above example is 11-pin type)

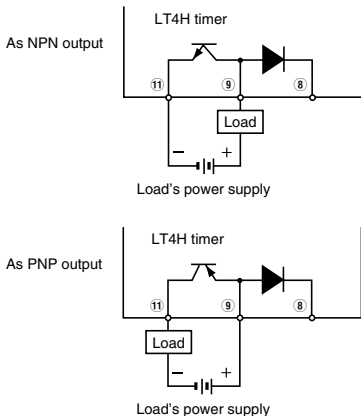

Note: With the 8-pin type, there is no diode between points ⑧ and ⑨.

(2) Use the diode connected to the output transistor's collector for absorbing the reverse voltage from induced loads.

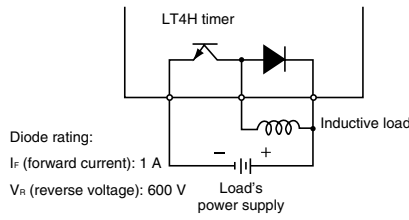

6) When wiring, use shielded wires or metallic wire tubes, and keep the wire lengths as short as possible.

7) For the load of the controlled output, make sure that it is lower than the rated control capacity.

4. Operation of LT4H digital timer

1) Turning on and off the power supply while operating in A2* (Power on delay 2) or G (Totalizing On delay) will result in a timer error to be generated due to the characteristics of the internal circuitry. Therefore, use the start input or stop input.

* Not related to the start input.

2) When controlling the timer by turning on the power supply, use only A (Power on delay 1) or A2 (Power on delay 2). Use of other modes in this situation will result in timer errors. When using the other modes, control the timer with the start input or stop input.

5. Operation mode and time range setting

The operation mode and time range can be set with the DIP switches on the side of the timer. Make the DIP switch settings before installing the timer on the panel.

The operation mode of LT4H-W series can be set with the keys and switches on the front of the timer.

6. Conditions of usage

1) Avoid locations subject to flammable or corrosive gases, excessive dust, oil, vibrations, or excessive shocks.

2) Since the cover of the timer is made of polycarbonate resin, avoid contact with or use in environments containing methyl alcohol, benzene, thinners, and other organic solvents; and ammonia, caustic sodas, and other alkaline substances.

3) If power supply surges exceed the values given below, the internal circuits may become damaged. Be sure to use surge absorbing element to prevent this from happening.

Operating voltage	Surge voltage (peak value)
AC type	6,000V
DC type 24V AC type	1,000V

• Surge wave form

[$\pm (1.2 \times 50) \mu\text{s}$ uni-polar full wave voltage]

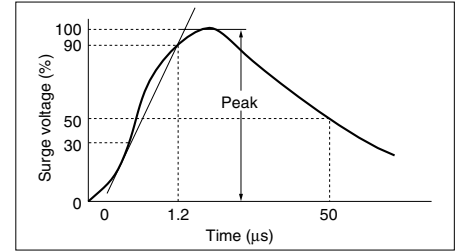

4) Regarding external noise, the values below are considered the noise-resistant voltages. If voltages rise above these values, malfunctions or damage to the internal circuitry may result, so take the necessary precautions.

	Power supply terminals		Input terminals
	AC type	DC type 24V AC type	
Noise voltage	1,500V	1,000V	600V

Noise wave form (noise simulator)

Rise time: 1 ns

Pulse width: 1 μs , 50 ns

Polarity: \pm

Cycle: 100 cycles/second

5) When connecting the operating power supply, make sure that no leakage current enters the timer. For example, when performing contact protection, if set up like that of fig. A, leaking current will pass through C and R, enter the unit, and cause incorrect operation. The fig. B shows the correct setup.

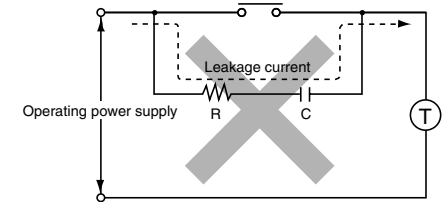

(Fig. A)

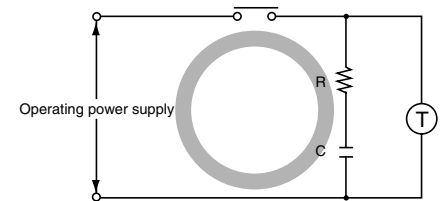

(Fig. B)

PRECAUTIONS IN USING THE LT4H SERIES

6) Long periods of continuous operation in the time-up completed condition (one month or more) will result in the weakening of the internal electrical components from the generated heat and, therefore, should be avoided. If you do plan to use the unit for such continuous operation, use in conjunction with a relay as shown in the circuit in the diagram below.

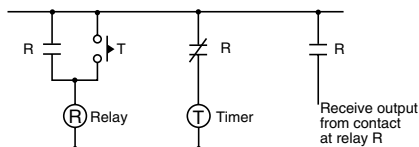

7. Acquisition of CE marking

Please abide by the conditions below when using in applications that comply with EN61812-1.

- 1) Overvoltage category III, pollution level 2
 - 2) This timer employs a power supply without a transformer, so the power and input signal terminals are not insulated.
 - (1) When a sensor is connected to the input circuit, install double insulation on the sensor side.
 - (2) In the case of contact input, use dual-insulated relays, etc.
 - (3) The load connected to the output contact should have basic insulation.
- This timer is protected with basic insulation and can be double-insulated to meet EN/IEC requirements by using basic insulation on the load.

- 4) Please use a power supply that is protected by an overcurrent protection device which complies with the EN/IEC standard (example: 250 V 1 A fuse, etc.).
- 5) You must use a terminal socket or socket for the installation. Do not touch the terminals or other parts of the timer when it is powered. When installing or un-installing, make sure that no voltage is being applied to any of the terminals.
- 6) Do not use this timer as a safety circuit. For example when using a timer in a heater circuit, etc., provide a protection circuit on the machine side.

7. Self-diagnosis function

If a malfunction occurs, one of the following displays will appear.

Display	Contents	Output condition	Restoration procedure	Preset values after restoration
EH-00	Malfunctioning CPU.	OFF	Enter reset input, RESET key, or restart unit.	The values at start-up before the CPU malfunction occurred.
EH-01	Malfunctioning memory. See note.			0

Note: Includes the possibility that the EEPROM's life has expired.

DIN SIZE TIMERS COMMON OPTIONS

Terminal sockets (Unit: mm inch, Tolerance: $\pm 1 \pm .039$)

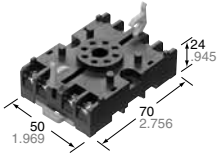
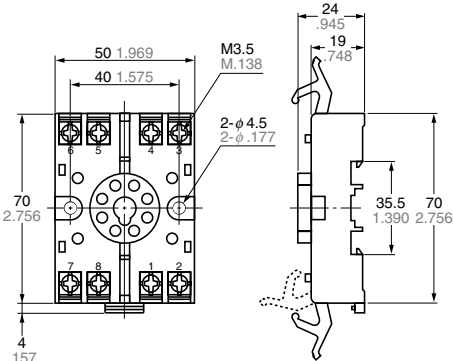
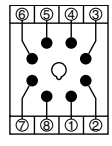
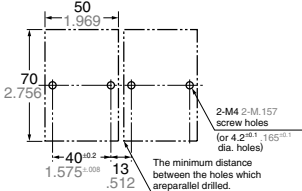
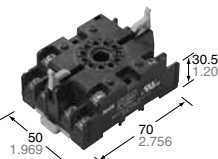
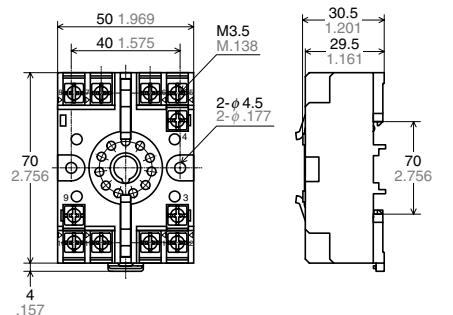
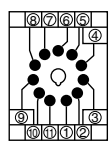
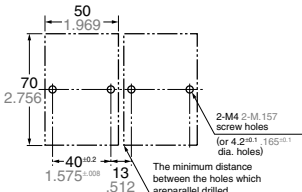
Type	Appearance	Dimensions	Terminal wiring (Top view)	Mounting hole dimensions
PM4H-S PM4H-M PM4H-SD PM4H-F8 PM4H-F8R PM4H-W LT4H LT4H-L LT4H-W QM4H PM4S (8-pin type)	<ul style="list-style-type: none"> DIN rail socket (8-pin)  <p>ATC180031</p>		 <p>Note: Terminal No. on the main body are identical to those on the terminal socket.</p>	
PM4H-A PM4H-F11R LT4H LT4H-W (11-pin type)	<ul style="list-style-type: none"> DIN rail socket (11-pin)  <p>ATC180041</p>		 <p>Note: Terminal No. on the main body are identical to those on the terminal socket.</p>	

Note: The socket's numbering system matches that of the timer terminals.

Sockets (Unit: mm inch, Tolerance: $\pm 1 \pm .039$)

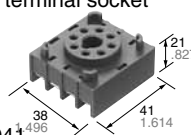
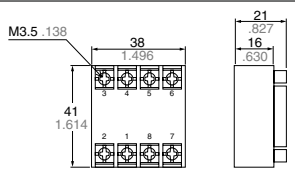
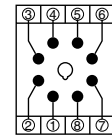
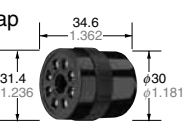
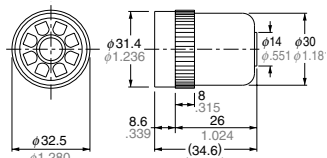
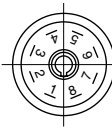
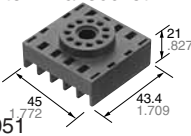
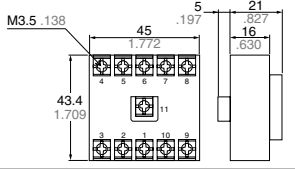
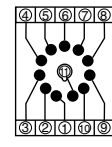
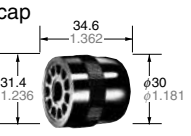
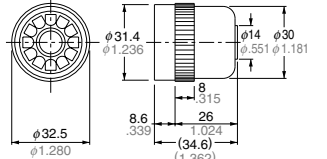
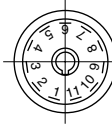
Type	Appearance	Dimensions	Terminal wiring (Top view)	Mounting hole dimensions
PM4H-S PM4H-M PM4H-SD PM4H-F8 PM4H-F8R PM4H-W LT4H LT4H-L LT4H-W (8-pin type) PM4S QM4H	<ul style="list-style-type: none"> Rear terminal socket  <p>AT78041</p>			—
8P cap LT4H-L LT4H-W (8-pin type) PM4S QM4H	<ul style="list-style-type: none"> 8P cap  <p>AD8-RC</p>			—
PM4H-A PM4H-F11R LT4H LT4H-W (11-pin type)	<ul style="list-style-type: none"> Rear terminal socket  <p>AT78051</p>			—
11P cap	<ul style="list-style-type: none"> 11P cap  <p>AT8-DP11</p>			—

Note: The terminal socket's numbering system matches that of the timer terminals.

MOUNTING PARTS

• Rubber gasket

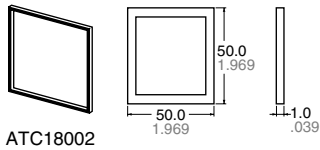

Applicable for PM4H series and LT4H series

The rubber gasket is enclosed in the PM4H (screw terminal type) and the LT4H series.

• Mounting frame

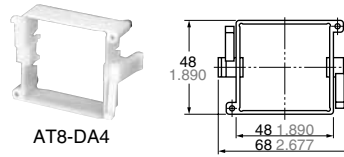

Applicable for PM4H series LT4H series and QM4H series

• Mounting rails (Applicable for DIN and IEC standards)

AT8-DLA1
Length: 1 m
aluminum

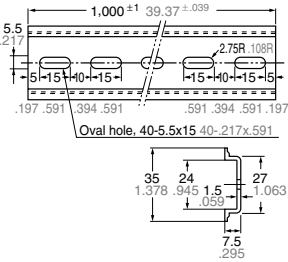

• Fastening plate



ATA4806

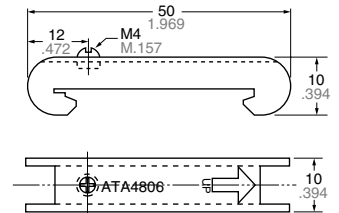

For holding DIN rails

• Protective cover for DIN 48 size: LT4H, QM4H series

Flexible type

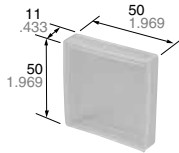

AQM4803

• Protective cover for DIN 48 size: QM4H series

Hard type

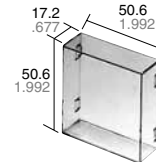

AQM4801

Accessories

PM4H series

• Panel cover (Black)

PM4H-A



ATC18011

PM4H-S



ATC18012

PM4H-M



ATC18013

PM4H-W



ATC18014

PM4H-SD



ATC18015

PM4H-F



ATC18016

LT4H series

• Panel cover (Black)

LT4H



ATL58011

LT4H-W



ATL68011

The black panel cover is also available so that you can change the appearance of the panel by changing the panel cover. The color of the standard panel cover is ash gray.

• Set ring

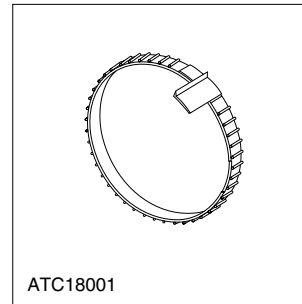

ATC18001

When you control the fixed time range, the setting rings (a set of 2 pcs.) make it easy to do the time setting and keep the time range all the time. (Excluding PM4H-W)

INSTALLING DIN SIZE TIMER

Installations

1. Surface mount

1) For the timers of PM4H and LT4H series, use the pin type timer. With the PM4S and QM4H series, only pin-type timers are available.

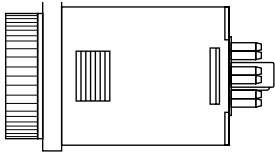

- 2) Put the terminal socket on the board directly or put it on the DIN rail (Fig. 1).
- 3) Insert the timer into the terminal socket and fix it with clip (Fig. 2)
- 4) On DIN rail mounting, mount the timer on the DIN rail tightly to get the proper dimension (Fig. 3).

(Fig. 1)

(Fig. 2)

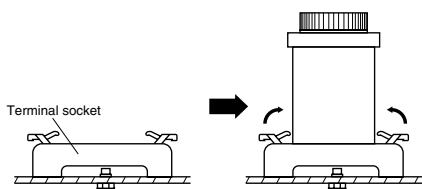

(Fig. 3)

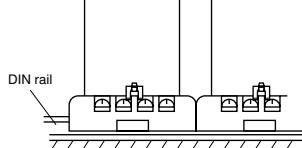

5) 8-pin type should be connected with terminal socket (AT8-DF8K). 11-pin type should be connected with terminal socket (AT8-DF11K).

6) DIN rail (AT8-DLA1) is also available (1 m).

2. Flush mount

1) For the timers of PM4H and LT4H series, it is recommended to use the built-in screw terminal type for flush mount. (Mounting frame and rubber gasket are provided when timer is shipped.)

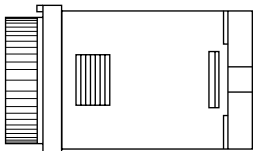

If the pin type is used, the mounting frame (AT8-DA4) and rubber gasket (ATC18002 for surface waterproofing) that are available at extra costs are necessary. If the pin connection socket is the 8-pin type, use the 8P cap (AD8-RC); or if it is the 11-pin type, use the 11P cap (AT8-DP11).

2) How to mount the timer

From the panel front, pass the timer through the square hole. Fit the mounting frame from the rear, and then push it in so that the clearance between the mounting frame and the panel surface is minimized. In addition, lock the mounting frame with a screw.

• Screw terminal type

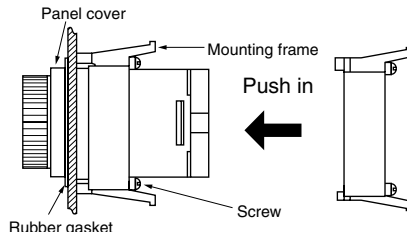

• Pin type

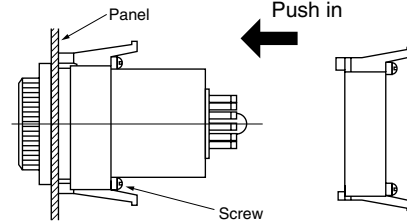

3) Caution in mounting the timer

• PM4H, and LT4H series

(a) If the PM4H and the LT4H series are used as the waterproof types, tighten the reinforcing screws on the mounting frames so that the timers, the rubber gaskets, and the panel surfaces are tightly contacted with each other. (Tighten the two screws with uniform force and make sure that there is no rattling. If the screws are tightened too excessively, the mounting frame may come off.)

(b) If the timer is installed with the panel cover and the rubber gasket removed, the waterproofing characteristic is lost.

4) Installation
Loosen the screws on the mounting frame, spread the edge of frame and remove it.

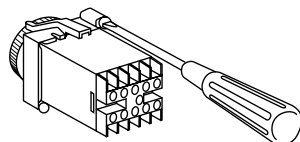

Pull the mounting frame backward while spreading out its hooks with your thumbs and index fingers.

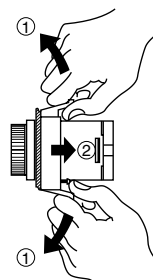

5) Correctly connect the pins while seeing the pin connection diagram.

Tighten the terminal screws with a torque of 0.8 N·cm or less. The screws are M3.5. (screw-tightened terminal type)

6) If the pin type is used, the rear terminal block (ATC78041) or the 8P cap (AD8-RC) is necessary to connect the pins. For the 11-pin type, use the rear terminal block (ATC78051) or the 11P cap (AT8-DP11) and avoid directly soldering the round pins on the timer.

7) Panel cutout dimensions

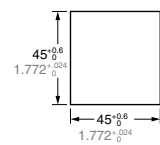

The standard panel cutout dimensions are shown in the left figure. (Panel thickness: 1 to 5 mm .039 to .197 inch)

8) Although the timers can be mounted adjacent to each other in this case, it is recommended to arrange the mounting holes as shown in the right figure to facilitate attaching and detaching the mounting frame.

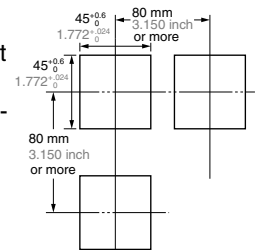

9) Adjacent mounting
Although the timers can be mounted adjacent to each other, remember that the panel surface of PM4H or LT4H series timer will lose its water-resistant effect. (Panel thickness: 1 to 5 mm .039 to .197 inch)







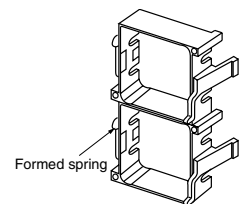
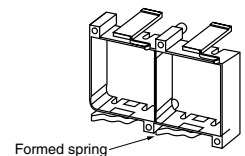





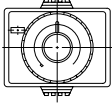



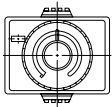













$$A = (48 \times n - 2.5)^{+0.6} \text{ (mm)}$$

When lining up the timers horizontally, set the frames in such a position so the formed spring areas are at the top and bottom. When lining up the timers vertically, set the frames in such a position so the formed spring areas are at the right and left.





























DISCONTINUED MODELS AND RECOMMENDED SUBSTITUTES

















Timers















Discontinued models	Recommended substitutes	Attachment	Discontinued models	Recommended substitutes	Attachment
MHP-NS (Exposed type Square plug-in/ horizontal type) 	MHP-N (Exposed type Round plug-in/ vertical type) 	Terminal base AT8-RFD should be used.	CHP-NF (Exposed type Round plug-in/ vertical type) 	PM4H-F 	Attachment frame AT7821 should be used. * External dimensions, however, differ. In addition, the reset method changes from voltage input to non-voltage input.
MHP-NS-	MHP-N-		CHP-NF	PM4HF-	
MHP-M (Exposed type Round plug-in/ horizontal type) 	MHP-NM (Exposed type Round plug-in/ vertical type) 	Terminal base AT8-RFD should be used.	CHP-SD 	PM4H-SD 	With exposed attachment, terminal base ATC180041 should be used. * External dimensions and contact capacity, however, differ. In addition, with the PM4H-SD: 1) (1) to (8) have no internal connection, and 2) the input (star) changes to 1a.
MHP-M-	MHP-NM-		CHP-SD-	PM4HSD-	
MHP-YC (Embedded type With attachment frame) 	MHP-N (Exposed type Without attachment frame) 	Attachment frame AT7821 should be used.	PM48A 	PM4H-A 	With exposed attachment, terminal base ATC180041 should be used.
MHP-YC-	MHP-N-		PM48A-	PM4HA-	
MHP-YM (Embedded type With attachment frame) 	MHP-NM (Exposed type Without attachment frame) 	Attachment frame AT7831 should be used.	PM48 	PM4H-S 	With exposed attachment, terminal base ATC180031 should be used.
MHP-YM-	MHP-NM-		PM48	PM4HS-	
CHP-N (Exposed type with attachment frame type) 	PM4H-S PMH 	The external dimension and contact capacity are different.	PM48M 	PM4H-M 	With exposed attachment, terminal base ATC180031 for F8 type and F8R type ATC180041 for F11R type.
CHP-N-	PM4HS- PMH-		PM48M-	PM4HM-	
CHP-N (Exposed type without attachment frame type) 	PM4H-S PMH 	The external dimension and contact capacity are different.	PM48F 	PM4H-F 	With exposed attachment, terminal base ATC180031 for F8 type and F8R type ATC180041 for F11R type.
CHP-N-	PM4HS- PMH-		PM48F-	PM4HF-	
CHP-NF (Exposed type without attachment frame type) 	PM4H-F 	* External dimensions, however, differ. In addition, the reset method changes from voltage input to non-voltage input.	PM48SD 	PM4H-SD 	With exposed attachment, terminal base ATC180031 should be used.
CHP-NF-	PM4HF-		PM48SD	PM4HSD	

Timers

Discontinued models	Recommended substitutes	Attachment	Discontinued models	Recommended substitutes	Attachment
PM48W 	PM4H-W 	With exposed attachment, terminal base ATC180031 should be used.	LT48 (8-pin) 	LT4H (8-pin) 	
PM48W PMH-M 	PM4H-W- PM4H-M/PM4S 	The external dimension and contact capacity are different.	LT48 LT48W (8-pin) 	LT4H LT4H-L LT4H-W (8-pin) 	
PMH-M- CDX Time relay 	PM4HM-/PM4S- S1DXM-A Timer/ S1DX Timer 		LT48W LT48W (8-pin) 	LT4HW LT4H-W (8-pin) 	
CDX PDX Timer 	S1DXM-A Timer/ S1DX Timer 		DIN rail socket (8-pin) 	DIN rail socket (8-pin) 	
PDX VHP digital high-power timer 	S1DXM-A Timer/ S1DX Timer 		ATC18003 DIN rail socket (11-pin) 	ATC180031 DIN rail socket (11-pin) 	
VHP QM48S (8-pin) 	QM4H digital timer 	The size is different. Compact size ↓ DIN48	ATC18004 DIN rail socket (11-pin) 	ATC180041 DIN rail socket (11-pin) 	
QM48S QM72S (Screw terminal) 	QM4H (8-pin) 	The size is different. □72 ↓ □48			
QM72S	QM4H				

In some cases, the specifications of the recommended substitutes are not exactly the same as those of the discontinued model. Please confirm the specifications before using the recommended substitutes.

Counters		
Discontinued models	Recommended substitutes	Attachment
MC electromagnetic counters  MC6	LC4H  LC4H LC4H-L	The size and attachment method are different. The input method is different. (Voltage input → non-voltage input)
LC48 (Relay type: 8-pin Tr type: 11-pin)  LC48	LC4H (Relay type: 8-pin Tr type: 11-pin)  LC4H LC4H-L	
LC48W (11-pin)  LC48W	LC4H-W (11-pin)  LC4H-W	
EM48S (8-pin)  EM48S	LC4H (8-pin)  LC4H LC4H-L	
EM72S (Screw terminal)  EM72S	LC4H (Screw terminal)  LC4H LC4H-L	The size is different. <input type="checkbox"/> 72  <input type="checkbox"/> 48
LC24 Panel-mounting type  <ul style="list-style-type: none"> • One-touch installation type LC24 	LC2H Panel-mounting type   <ul style="list-style-type: none"> • One-touch installation type • Installation frame type LC2H 	The both one-touch installation type and installation frame type are available.
LC24 PC board mounting type  LC24	LC2H PC board mounting type  LC2H	

Hour meters		
Discontinued models	Recommended substitutes	Attachment
 TH11* TH12*	 TH141S TH142S	Body Round type (attachment hole ϕ 45)  Square type (attachment hole \square 45)
 TH21* TH22*	 TH241S TH242S	Body Square type (attachment hole \square 47)  Square type (attachment hole \square 45)
TH30  TH30	LT4H (~999.9 h)  LT4H LT4H-W (~9999 h)  LT4HW	The size and attachment method are different. The input method is different. (Voltage input → non-voltage input)
LH24 Panel-mounting type  <ul style="list-style-type: none"> • One-touch installation type LH24 	LH2H Panel-mounting type   <ul style="list-style-type: none"> • One-touch installation type • Installation frame type LH2H 	The both one-touch installation type and installation frame type are available.
LH24 PC board mounting type  LH24	LH2H PC board mounting type  LH2H	

In some cases, the specifications of the recommended substitutes are not exactly the same as those of the discontinued model. Please confirm the specifications before using the recommended substitutes.

FOREIGN SPECIFICATIONS OVERVIEW

1. International Standards

IEC standard

International Electrotechnical Commission

By promoting international cooperation toward all problems and related issues regarding standardization in the electrical and electronic technology fields, the IEC, a non-governmental organization, was started in October, 1908, for the purpose of realizing mutual understanding on an international level. To this end, the IEC standard was enacted for the purpose of promoting international standardization.

2. North America

UL (Underwriters Laboratories Inc.)

This is a non-profit testing organization formed in 1894 by a coalition of U.S. fire insurance firms, which tests and approves industrial products (finished products). When electrical products are marketed in the U.S., UL approval is mandated in many states, by state law and city ordinances. In order to obtain UL approval, the principal parts contained in industrial products must also be UL-approved parts.

UL approval is divided into two general types. One is called "listing" (Fig. 1), and applies to industrial products (finished products). Under this type of approval, products must be approved unconditionally. The other type is called "recognition" (Fig. 2), and is a conditional approval which applies to parts and materials.

CSA (Canadian Standards Association)

This was established in 1919 as a non-profit, non-governmental organization aimed at promoting standards. It sets standards for industrial products, parts, and materials, and has the authority to judge electrical products to determine whether they conform to those standards. The CSA is the ultimate authority in the eyes of both the government and the people in terms of credibility and respect. Almost all states and provinces in Canada require CSA approval by law, in order to sell electrical products. As a result, electrical products exported from Japan to Canada are not approved under Canadian laws unless they have received CSA approval and display the CSA mark. Approval is called "certification", and products and parts which have been approved are called "certified equipment", and display the mark shown in Fig. 3. The mark shown in Fig. 4 is called the "Component Acceptance" mark, and indicates conditional approval which is applicable to parts. The C-UL mark shown in Fig. 5 (finished products) and Fig. 6 (parts) indicates that the product has been tested and approved in UL laboratories, based on UL and CSA standards, through mutual approval activities.

LISTING MARK



Fig. 1

RECOGNITION MARK



Fig. 2

Certification



Fig. 3

Component Acceptance



Fig. 4



Fig. 5



Fig. 6

3. Europe

EN standard

European Standards/Norme Europeenne (France)/Europaishe Norm (Germany)

Abbreviation for European Standards. A unified standard enacted by CEN/CENELEC (European Standards Committee/European Electrical Standards Committee). EU and EFTA member nations employ the content of the EN standards into their own national standards and are obligated to abolish those national standards that do not agree with the EN standards.

(1) Germany



VDE (Verband Deutscher Elektrotechniker)

The VDE laboratory was established mainly by the German Electric Technology Alliance, which was formed in 1893. It carries out safety experiments and passes approval for electrical devices and parts. Although VDE certification is not enforced under German law, punishment is severe should electrical shock or fire occur; therefore, it is, in fact, like an enforcement.



TÜV (Technischer Überwachungs-Verein)

TÜV is a civilian, non-profit, independent organization that has its roots in the German Boiler Surveillance Association, which was started in 1875 for the purpose of preventing boiler accidents. A major characteristic of TÜV is that it exists as a combination of 14 independent organizations (TÜV Rheinland, TÜV Bayern, etc.) throughout Germany. TÜV carries out inspection on a wide variety of industrial devices and equipment, and has been entrusted to handle electrical products, as well, by the government. TÜV inspection and certification is based mainly on the VDE standard. TÜV certification can be obtained from any of the 14 TÜVs throughout Germany and has the same effectiveness as obtaining VDE certification.

4. Shipping Standards

(1) Lloyd's Register of Shipping



Standards from the Lloyd's Register shipping association based in England. These standards are safety standards for environmental testing of the temperature and vibration tolerances of electrical components used for UMS (unmanned machine rooms in marine vessels) applications. These standards have become international standards for control equipment in all marine vessel applications. No particular action is taken to display the conformation to these standards on the products.

5. Pilot Duty

One of the specifications in the “UL508 Industrial Control Equipment” regulations at UL (Underwriters Laboratories Inc.), has to do with the grade of contact control capacity by NEMA (National Electrical Manufacturers Association) standards. By obtaining both UL and CSA approval for this grade, the product becomes authorized publicly.

Pilot Duty A300

AC applied voltage [V]	Electrification current [A]	Input power [A]	Breaker power [A]	[VA]	
				During input	During breaker
120	10	60	6	7,200	720
240		30	3	7,200	720















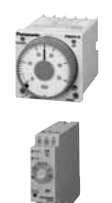
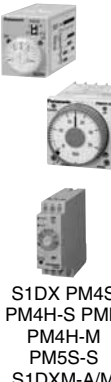
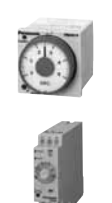

Pilot Duty B300

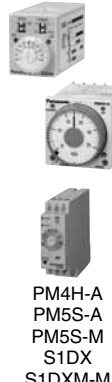
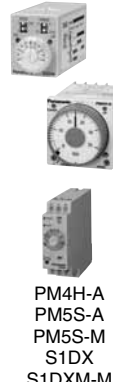
AC applied voltage [V]	Electrification current [A]	Input power [A]	Breaker power [A]	[VA]	
				During input	During breaker
120	5	30	3	3,600	360
240		15	1.5	3,600	360

Pilot Duty C300

AC applied voltage [V]	Electrification current [A]	Input power [A]	Breaker power [A]	[VA]	
				During input	During breaker
120	2.5	15	1.5	1,800	180
240		7.5	0.7	1,800	180













TIMERS CHART

		Multiple operation	ON-delay	OFF-delay	Twin	Flicker	One-shot	Star delta	One-cycle	Integration
Digital quartz timer	Surface mount/Flush mount	 LT4H LT4H-L LT4H-W	 LT4H LT4H-L QM4H	 LT4H (Signal) LT4H-L	 LT4H-W	 LT4H LT4H-L	 LT4H LT4H-L			 LT4H LT4H-L
	Multi-range analog timer (CR oscillation)	 PM4H-A PM5S-A	 S1DX PM4S PM4H-S PMH PM4H-M PM5S-S S1DXM-A/M	 PM4H-A (Signal) PM4H-F PM5S-A (Signal) PM5S-M (Signal)	 PM4H-W	 PM4H-A PM5S-A PM5S-M S1DX S1DXM-M	 PM4H-A PM5S-A PM5S-M S1DX S1DXM-M	 PM4H-SD/SDM	 S1DX	
Multi-range analog timer (CR oscillation)	Relay terminal socket		 S1DX S1DXM-A/M			 S1DX S1DXM-M	 S1DX S1DXM-M			 S1DX
	PC board mount		 S1DX							
Motor drive timer	Surface mount/Flush mount		 MHP MHP-M							

TIMERS SELECTOR CHART

Operation mode		Power ON-delay	Pulse ON-delay Pulse Flicker Pulse ON-Flicker Differential ON/OFF-delay (1)(2) Signal OFF-delay Pulse One-shot Pulse One-cycle	Power ON-delay	Power ON-delay Power Flicker Power ON-flicker Power One-shot Power One-cycle (with instantaneous contact)	Star-Delta	Power OFF-delay
Major uses		For time control for short or long time	For time control for short or long time	For time control for short or long time	For self holding circuit	For SD motor start-up	For all uses of power OFF-delay
Time range		CR oscillation counting timer					
1000h 100h 30h 10h 1h 30m 10m 5m 2m 1m 30s 10s 5s 1s 0.1s 0.01s Each model has various time ranges. See the product lists before ordering.		 4 time ranges selectable		 16 time ranges selectable		 4 time ranges selectable 100s 10s 0.2s 10min 3 time ranges selectable 0.04min 3 time ranges selectable - 0.04s	
Model/Product Name		PM4S Multi-range analog timer	PM4H-A Multi-range analog timer	PM4H-S Multi-range analog timer	PM4H-M Multi-range analog timer	PM4H-SD/SDM Star-Delta timer	PM4H-F8/-F8R/-F11R OFF-delay timer
Features		An affordable new series timers	16 time ranges are selectable. 1s to 500h (Max. range) is controlled. 8 operation modes available.	16 time ranges are selectable. 1s to 500h (Max. range) is controlled in one unit.	16 time ranges are selectable. 1s to 500h (Max. range) is controlled in one unit. 5 operation modes (with instantaneous contact) available.	4 time ranges are selectable. 2s to 100s (Max. range) is controlled in one unit. 5 time ranges selectable for the Δ - Δ switching times.	Multiple time ranges are selectable. Power-OFF delay of max. 10 min. is controlled.
Control output (resistive)	Current	7A 5A 3A	5A	5A	5A	5A	3A
	Voltage	250 V AC	250 V AC	250 V AC	250 V AC	250 V AC	250 V AC
Mounting method							
Mounting parts		Terminal block, cap	Terminal block, cap, panel cover, rubber gasket, mounting frame	Terminal block, cap, panel cover, rubber gasket, mounting frame	Terminal block, cap, panel cover, rubber gasket, mounting frame	Terminal block, cap, panel cover, rubber gasket, mounting frame	Terminal block, cap, panel cover, rubber gasket, mounting frame
Rated operating voltage		100 to 120 V AC, 200 to 240 V AC, 12 V DC 24 V DC	100 to 240 V AC, 48 to 125V DC, 24 V AC/DC, 12 V DC (other models)	100 to 240 V AC, 48 to 125V DC, 24 V AC/DC, 12 V DC (other models)	100 to 240 V AC, 48 to 125V DC, 24 V AC/DC, 12 V DC (other models)	100 to 240 V AC, 24 V AC (other models)	100 to 120 V AC, 200 to 240 V AC, 12 V DC, 24 V DC, 24 V AC (other models)
Arrangement		T.D: Timed-out 2 Form C INST: Timed-out 1 Form C instantaneous 1 Form C Selected by front switch	Timed-out 2 Form C	Timed-out 2 Form C	Timed-out 1 Form C Instantaneous 1 Form C	Δ side: Timed-out 1 Form A Δ side: Timed-out 1 Form A Instantaneous: 1 Form A	Timed-out 2 Form C Timed-out 1 Form C [F8R type]
Time accuracy	Operation time fluctuation	$\pm 1\%$ (power off time charge at the range of 0.1s to 1h)	$\pm 0.3\%$	$\pm 0.3\%$	$\pm 0.3\%$	$\pm 0.3\%$	$\pm 0.3\%$
	Temperature error	$\pm 2\%$ (at 20°C ambient temp. at the range of -10 to +50°C)	$\pm 2\%$	$\pm 2\%$	$\pm 2\%$	$\pm 2\%$	$\pm 2\%$
	Voltage error	$\pm 1\%$ (at the operating voltage changes between 85 to 110%)	$\pm 0.5\%$	$\pm 0.5\%$	$\pm 0.5\%$	$\pm 0.5\%$	$\pm 0.5\%$
	Setting error	$\pm 5\%$	$\pm 5\%$	$\pm 5\%$	$\pm 5\%$	$\pm 5\%$	$\pm 5\%$
Min. power off time		100 ms	100 ms	100 ms	100 ms	500 ms	—
Life (Min. operation)	Mechanical	10^7	2×10^7	2×10^7	2×10^7	2×10^7	10^7
	Electrical	10^5	10^5	10^5	10^5	10^5	10^5
Terminal layouts and wiring diagrams		Pin type T.D: Timed-out 2 Form C INST: Timed-out 1 Form C, instantaneous 1 Form C * Selected by front switch	Pin type Screw terminal type 	Pin type Screw terminal type 	Pin type Screw terminal type 	Pin type No instantaneous contact Pin type With instantaneous contact 	Pin type Screw terminal type
Available standards		UL/c-UL, CE	UL/CSA, CE, LLOYD	UL/CSA, CE, LLOYD	UL/CSA, CE, LLOYD	UL/CSA, CE, LLOYD	UL/CSA, CE, LLOYD
Page		P. 13	P. 17	P. 17	P. 17	P. 23	P. 25

TIMERS SELECTOR CHART

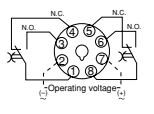
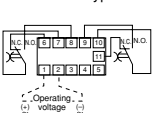
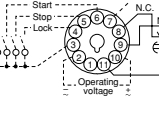
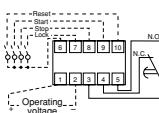
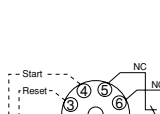
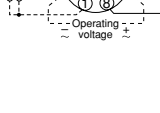
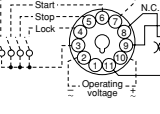
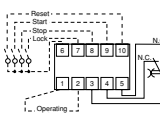
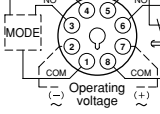
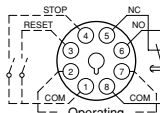
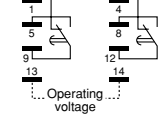
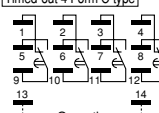
Operation mode		Power OFF-start cyclic	Power ON delay (1) Power ON delay (2) Signal ON delay Signal OFF delay Pulse One-shot Pulse ON-delay Signal Flicker Totalizing ON-delay	Power ON delay (1) Power ON delay (2) Signal ON delay Signal OFF delay Pulse One-shot Pulse ON-delay Signal Flicker Totalizing ON-delay	ON-start flicker OFF-start flicker Delay one-shot	Power ON-delay	Power ON-delay Power flicker Power One-shot
Major uses		CR oscillation counting timer For repetitive ON/OFF operation	Quartz oscillation counting timer Suitable for super-high accurate, digital setting				CR oscillation counting timer For highly accurate time setting
Time range		1000h 100h 30h 10h 1h 30m 10m 5m 2m 1m 30s 10s 5s 1s 0.1s 0.01s	999.9h 8 time ranges selectable	999.9h 8 time ranges selectable	9999h 8 time ranges selectable	9990h	10min 30min 60min 10h 3s
Model/Product Name		 PM4H-W Analog multi-range cyclic twin timer	 LT4H Digital timer	 LT4H-L Digital timer	 LT4H-W Digital timer	 QM4H Timer	 S1DXM-A/M Timer
Features		16 time ranges are selectable. 1s to 500h (Max. range) is controlled in one unit.	Bright and easy-to-read display Simple operation Short body	Economically price. Display is a bright reflective-type LCD.	Bright and easy-to-read display Simple operation Wide time setting range	Possible to set and change the time with front digit switches easily during the power off. Furthermore single unit has a time range of 0.01s to 9990hrs!!	With a large transparent dial. This timer can be attached both on the DIN rails and panel.
Control output (resistive)	Current	7A 5A 3A	(Relay output type) 5A (Transistor output type) 100mA	(Relay output type) 5A (Transistor output type) 100mA	(Relay output type) 5A (Transistor output type) 100mA	5A	7A 2 Form C type 5A 4 Form C type
	Voltage	250 V AC	250 V AC 30 V DC	250 V AC 30 V DC	250 V AC 30 V DC	250 V AC 30 V DC	250 V AC
Mounting method							
Mounting parts		Terminal block, cap, panel cover, rubber gasket, mounting frame	Terminal block, cap, panel cover, rubber gasket, mounting frame	Terminal block, cap, panel cover, rubber gasket, mounting frame	Terminal block, cap, panel cover, rubber gasket, mounting frame	Terminal block, cap, panel cover, rubber gasket, mounting frame	Terminal block, cap block, mounting frame, fitting sockets, protective cover
Rated operating voltage		100 to 240 V AC, 48 to 125V DC, 24 V AC/DC, 12 V DC (other models)	100 to 240 V AC 24 V AC 12 to 24 V DC (other models)	100 to 240 V AC 24 V AC 12 to 24 V DC (other models)	100 to 240 V AC 24 V AC 12 to 24 V DC (other models)	100 to 240 V AC/DC 12 to 48 V AC/DC (other models)	100 to 120 V AC, 200 to 220 V AC, 12 V DC, 24 V DC (other models)
Arrangement		Timed-out 2 Form C	(Relay output type) Timed-out 1 Form C (Transistor output type) Timed-out 1 Form A	(Relay output type) Timed-out 1 Form C (Transistor output type) Timed-out 1 Form A	(Relay output type) Timed-out 1 Form C (Transistor output type) Timed-out 1 Form A	T.D. mode: Time delay 2C INST. mode: Time delay 1C and instantaneous 1C (Use MODE switch on front)	Timed-out 2 Form C Timed-out 4 Form C
Time accuracy	Operation time fluctuation	±0.3%	±(0.005% + 50 ms) in case of power on start ±(0.005% + 20 ms) in case of reset or input signal start	±(0.005% + 50 ms) in case of power on start ±(0.005% + 20 ms) in case of reset or input signal start	±(0.005% + 80 ms) in case of power on start ±(0.005% + 20 ms) in case of reset or input signal start	±(0.01% + 0.05 s) in case of power on start ±0.005% ±0.03 s (G type only)	±1% ±5% ±1% ±10%
	Temperature error	±2%					
	Voltage error	±0.5%					
	Setting error	±5%					
Min. power off time		300 ms	500 ms	500 ms	500 ms	100 ms	100 ms
Life (Min. operation)	Mechanical	2 × 10 ⁷	2 × 10 ⁷	2 × 10 ⁷	2 × 10 ⁷	2 × 10 ⁷	10 ⁷
	Electrical	10 ⁵	10 ⁵ 10 ⁷	10 ⁵ 10 ⁷	10 ⁵ 10 ⁷	10 ⁵ 10 ⁷	2 × 10 ⁵
Terminal layouts and Wiring diagrams		Pin type  Screw terminal type 	11-Pin type  Screw terminal type 	 Screw terminal type 	11-Pin type  Screw terminal type 	QM4H-S type  QM4H-G type 	Timed-out 2 Form C type  Timed-out 4 Form C type 
Available standards		UL/CSA, CE, LLOYD	UL/c-UL, CE	UL/c-UL, CE	UL/c-UL, CE	UL/c-UL, CE	UL/c-UL, CE
Page		P. 29	P. 34	P. 34	P. 41	P. 50	P. 57

TIMERS SELECTOR CHART

Operation mode		Power ON-delay Power flicker Power One-shot Power One-cycle	Pulse ON-delay Pulse Flicker Pulse ON-Flicker Signal OFF-delay Pulse One-shot Pulse One-cycle	Power ON-delay	Pulse ON-delay Pulse Flicker Pulse ON-flicker Signal OFF-delay Pulse One-shot Pulse One-cycle (with instantaneous contact)	Power ON-delay	
		Output with contact	CR oscillation counting timer		CR oscillation counting timer	CR oscillation counting timer	
Major uses		For highly accurate time setting	For time control for short or long time	For time control for short or long time	For self holding circuit	For time ranges selection	
Time range	1000h	<p>Each model has various time ranges. See the product lists before ordering.</p>	<p>16 time ranges selectable.</p>	<p>16 time ranges selectable.</p>	<p>16 time ranges selectable.</p>	<p>4 time ranges selectable.</p>	
	100h						
30h							
1h							
30m							
10m							
5m							
2m							
1m							
30s							
10s							
5s							
1s							
0.1s							
0.01s							
Model/Product Name	<p>S1DX Timer</p>		<p>PM5S-A Multi-range analog timer</p>	<p>PM5S-S Multi-range analog timer</p>	<p>PM5S-M Multi-range analog timer</p>	<p>PMH Timer</p>	
	Features		With a large transparent dial. This timer can be attached both on the DIN rails and panel.	16 time ranges are selectable. 1s to 500h (Max. range) is controlled. 6 operation modes available.	16 time ranges are selectable. 1s to 500h (Max. range) is controlled in one unit.	16 time ranges are selectable. 1s to 500h (Max. range) is controlled in one unit. 6 operation modes (with instantaneous contact) available.	A multitimer is provided with the front operation slide switch by using the special C-MOSIC inside pulse oscillation counting method.
Control output (resistive)	Current	7A 5A 3A	7A 5A	5A	5A	5A	7A
	Voltage	250 V AC	250 V AC	250 V AC	250 V AC	250 V AC	250 V AC
Mounting method							
Mounting parts		Terminal block, cap block, mounting frame, fitting sockets, protective cover	Terminal block, cap, panel cover, rubber gasket, mounting frame	Terminal block, cap, panel cover, rubber gasket, mounting frame	Terminal block, cap, panel cover, rubber gasket, mounting frame	Terminal block, socket, cap, mounting frame, protective cover	
Rated operating voltage		100 to 120 V AC, 200 to 220 V AC, 12 V DC, 24 V DC, 48 V DC, 100 to 110 V DC (other models)	24 to 240V AC/DC	24 to 240V AC/DC	24 to 240V AC/DC	100 to 120 V AC, 200 to 240 V AC, 12 V DC, 24 V DC, 48 V DC, 100 to 110 V DC (other models)	
Arrangement		Timed-out 2 Form C Timed-out 4 Form C	Timed-out 2 Form C	Timed-out 2 Form C	Timed-out 1 Form C Instantaneous 1 Form C	Timed-out 2 Form C	
Time accuracy	Operation time fluctuation	±1%	±0.3%	±0.3%	±0.3%	±0.5%	
	Temperature error	±5%	±2%	±2%	±2%	±5%	
	Voltage error	±1%	±0.5%	±0.5%	±0.5%	±0.5%	
	Setting error	±10%	±10%	±10%	±10%	±10%	
Min. power off time		100 ms	100 ms	100 ms	100 ms	100 ms	
Life (Min. operation)	Mechanical	10 ⁷	2 × 10 ⁷	2 × 10 ⁷	2 × 10 ⁷	5 × 10 ⁷	
	Electrical (resistive)	2 × 10 ⁵	10 ⁵	10 ⁵	10 ⁵	2 × 10 ⁵	
Wiring diagrams							
Available standards		UL/CSA, CE, LLOYD	UL/C-UL	UL/C-UL	UL/C-UL	UL/CSA, LLOYD	
Page		P. 63	P. 73	P. 73	P. 73	P. 80	

TIMERS SELECTOR CHART

Operation mode		Power ON-delay	
Major uses		Motor timer	
Major uses		Suitable for high accurate, long time uses	
Time range			
Each model has various time ranges. See the product lists before ordering.			
Model/Product Name		 MHP Timer	 MHP-M Timer
Features		A motor timer with high accuracy. With a movable point and instantaneous contact (for the MHP-M)	
Control output (resistive)	Current	7A 5A 3A	5A
	Voltage	250 V AC	250 V AC
Mounting method		 	
Mounting parts		Terminal block, socket, cap, mounting frame, protective cover	
Rated operating voltage		100 V AC, 200 V AC (other models)	
Arrangement		Timed-out 1 Form C	Timed-out 1 Form C Instantaneous 1 Form A
Time accuracy	Operation time fluctuation	±2%	
	Temperature error	—	
	Voltage error	—	
	Setting error	—	
Min. power off time		300 ms	
Life (Min. operation)	Mechanical	10 ⁷	
	Electrical (resistive)	4 × 10 ⁵	
Wiring diagrams			
Available standards		UL/CSA, LLOYD	UL/CSA, LLOYD
Page		P. 82	P. 82

ON-DELAY TIMER BASIC CIRCUIT

(Symbols)	
	Self-resetting switch
	Holding switch
	Relay
	Timer
	Load
	Timer in work
	Relay NO contact
	Relay NC contact
	Timer delay NO contact
	Timer delay NC contact
	Timer instantaneous NO contact
	Timer instantaneous NC contact

1. Delay Operation (Instantaneous input)

When control switch A is pressed, timer T starts immediately and after t-time elapses, load L is turned ON. When B is pressed, timer T is reset and load L is turned OFF.

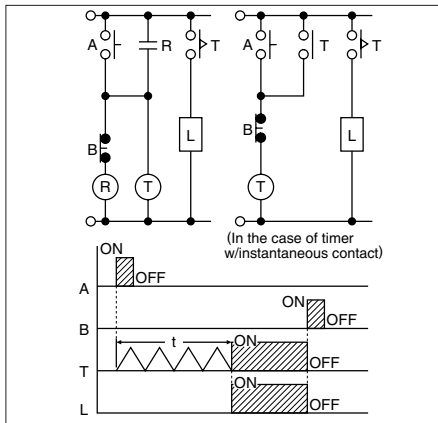

2. Delay Operation (Continuous input)

When switch A is pressed, after t-time elapsed, the timer contact closes and load L is turned ON. When switch A is opened, the timer is reset and the load is turned OFF.

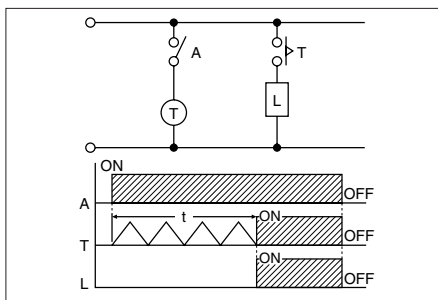

3. Fixed Time Operation (Instantaneous input)

When control switch A is pressed, load L is immediately turned ON, and after t-time elapses, load L is turned OFF.

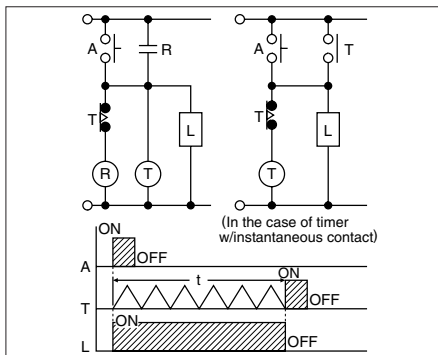

4. Fixed Time Operation (Continuous input)

When switch A is closed, load L is turned ON and after t-time elapses, the load is turned OFF. When switch A is opened, timer T is reset and load L is turned OFF.

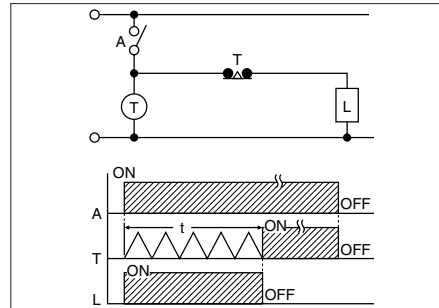

5. Delay Reset Operation

When contact A is reversed, load L is immediately turned ON. When contact A is returned to normal state, load L is turned OFF after t-time elapses. This circuit is used when the power supply is kept ON at all times or used for off-delay-like application. However, it can not be used as off-delay timer at the time of power failure.

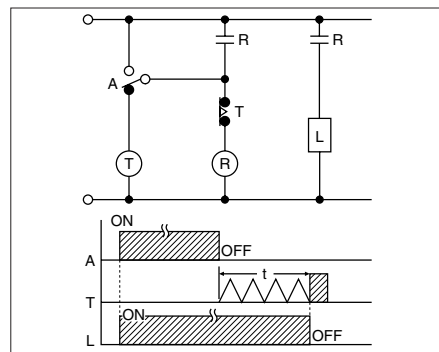

6. Fixed Time Operation after Delay Time is Set (Instantaneous input)

When control switch A is pressed, load L is turned ON after t1-time elapses, and load L is turned OFF after t2-time elapses. This circuit is used for the case of instantaneous input (one pulse).

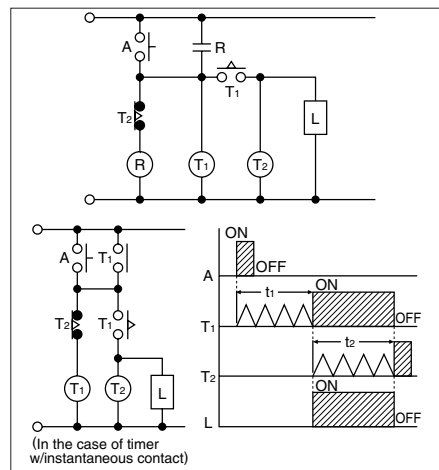

7. Fixed Time Operation after Delay Time is Set (Continuous input)

When switch A is pressed, load L is turned ON after t1-time elapses and load L is turned OFF after t2-time elapses.

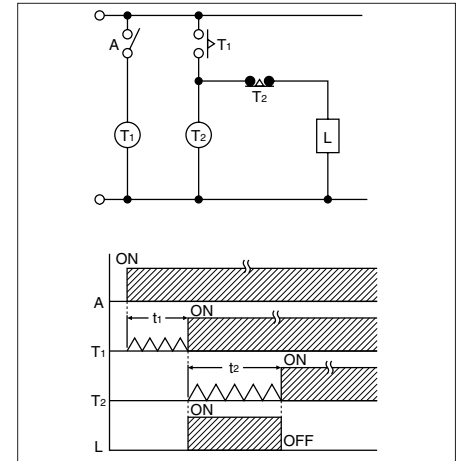

8. Repetitive Operation

When switch A is pressed, load L is turned ON after t1-time elapses and load L is turned OFF after t2-time elapses, and thereafter the t1 and t2 operations are repeated. This repetitive operation stops when switch A is turned OFF.

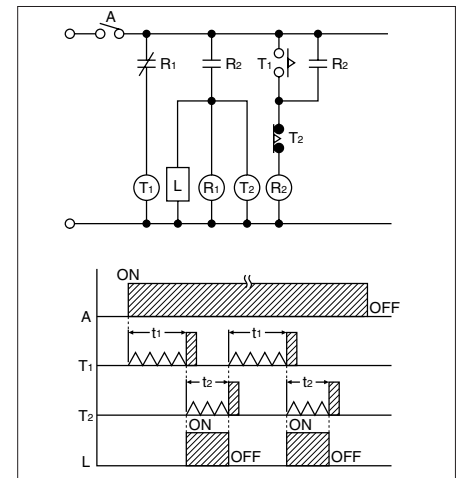

TIMER-RELATED TERMINOLOGY

• What is the timer?

The timer is a relay having such an output (with or without contact) which electrically closes (turns ON) or opens (turns OFF) the circuit after a preset time elapses when electrical or mechanical input is given.

• On-delay Operation (Time delay operation)

The on-delay operation is an operation to give output when preset time expires after a predetermined input is given to the power supply circuit or input circuit. On-delay operation includes power supply on-delay operation and signal on-delay operation.

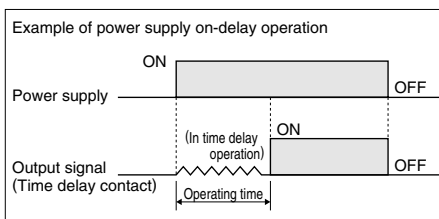

• Off-delay Operation (Time delay resetting)

The off-delay operation is an operation to turn OFF output when preset time expires after a predetermined input is given to the power supply circuit or input circuit, and at the same time output signal is given and predetermined input is turned OFF. Off-delay operation includes power supply off-delay operation and signal off-delay operation.

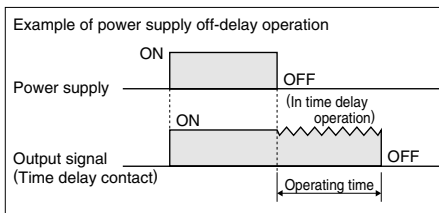

• Flicker Operation

The flicker operation is an operation to repeat output ON/OFF action according to preset ON time and OFF time while a predetermined input is given to the power supply circuit or input circuit. Flicker operation includes OFF-start flicker operation and ON-start flicker operation.

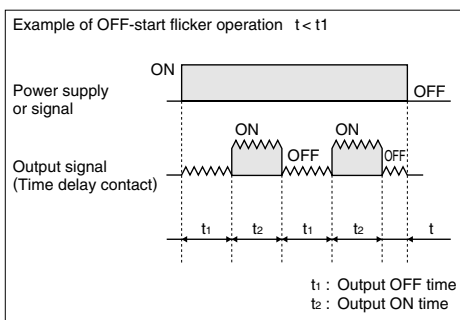

• Star (∧)/Delta (Δ) Operation

This operation controls the time in the star connection used for star-delta starting which is conducted for starting a cage induction motor and the time for switching the star connection over to delta connection.

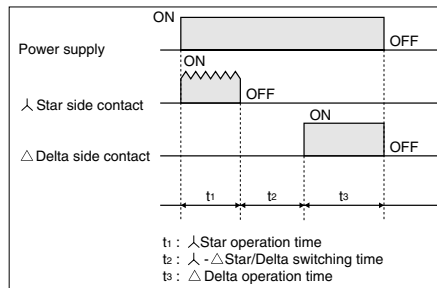

• Preset Time

The preset time is the control time set by setting time-variable timer.

• Operating Time

The operating time means the time which elapses between the addition of predetermined input to the power supply circuit and input circuit and the completion of operation for preset time.

• Hold Time

It means the time which elapses between the completion of operation for preset time and the start of resetting.

• Pause Time

It means the time elapses between the start of operation for preset time and the addition of input required again for the power supply circuit or input circuit. Timer does not perform normal function unless this pause time is set longer than the timer reset time.

• Resetting

It means that the operation returns to the state before starting while the timer is in operation for preset time or after it completes the operation for preset time. Resetting during the operation for preset time is referred to as halfway resetting.

• Reset Time

It means the time elapses between shut-off of input to the power supply circuit or input of reset signal and the completion of resetting.

Timer resetting function shares the reset of contact, reset of mechanical parts such as pointer etc., reset of parts in internal circuit such as capacitor etc., and the value at which all of these parts complete their resetting operation is regarded as reset time. If timer is used for a pause time shorter than specified reset time, the operation time expires earlier than preset, unexpected instantaneous operation takes place or the operation is failed, thus making it impossible

to expect the normal operation.

Therefore, be sure to set the timer pause time longer than the specified reset time.

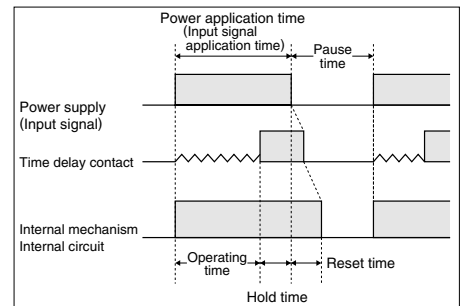

• Minimum Power Application Time

It means the minimum time during which power must be supplied in order to operate timer normally, in the case of power supply off-delay timer.

• Fluctuation of Operating Time

It means the irregularity in operating time caused when timer is set at specified time and the operation is repeated under the same conditions. It is also referred to as repetitive error.

• Voltage Error

It means the difference between the operating time at the rated voltage and that within the allowable voltage range.

• Temperature Error

It means the difference between the operating time at the temperature of $20 \pm 2^\circ\text{C}$ and that within the allowable temperature range.

• Set Error

It means the difference between the set time and the time which actually elapses. It is also referred to as setting error.

The set error of an analog timer is the rate to the full-scale value. If the set error is $\pm 5\%$, it becomes equivalent to an error of maximum ± 5 hours on the assumption that 100 hours is set in the range of 100 hours. The error produced when 10 hours is set is also equivalent to an error of maximum ± 5 hours. As far as the set error is concerned, digital timer is by far exact. Select a digital timer for the case when accuracy is required.

When using an analog type multi-range timer for setting of long time, the setting procedure stated as follows minimizes the error. For example, if you want to set 8 hours in the range of 10 hours, first set the pointer to such a graduation where the actual operating time should become as close to 8 seconds as possible in the range of 10 seconds. Then, reset the range to 10 hours, leaving the pointer set at the graduation as it is.

TIMER-RELATED TERMINOLOGY

• Pause Time Error

It means the difference between the operating time to a fixed pause time and the operating time to a pause time that varies. The pause time characteristics are the main characteristics of CR timer (timer exploiting charge and discharge of capacitor C and resistance R).

If the oscillation count timer (timer which comprises an oscillation circuit composed of CR and quartz and is operated by a counting circuit inside IC or micro-computer which counts the reference signal) is used, the pause time error becomes almost negligible owing to its principles of operation. Accordingly, the description about these characteristics may be omitted for the oscillation count timer.

• Equation for Each Error and Measurement Conditions

The operation time shall be measured, in principle, for retention time of 0.5 second and halt time of 1 second.

The measurement shall be repeated five times except for the initial test. The equation for each error and the measurement conditions are shown in the table below:

Item	Equation	Measurement conditions		
		Set value Ts (Note 1)	Supply voltage	Ambient temperature
(1) Fluctuation in operation time	$\pm \frac{1}{2} \times \frac{T_{\max.} - T_{\min.}}{TMs} \times 100 (\%)$	Full-scale value	Rated voltage	20±2°C 68±36°F (Note 2)
(2) Voltage error	$\frac{TMx_1 - TM}{TMs} \times 100 (\%)$		Fluctuation range of allowable voltage of power supply (Note 3)	
(3) Temperature error	$\frac{TMx_2 - TM}{TMs} \times 100 (\%)$		Rated voltage	-10 to 50°C +14 to 122°F (Note 4)
(4) Set error	$\frac{TM - Ts}{TMs} \times 100 (\%)$	1/3 or more of full-scale value	Rated voltage	20±2°C 68±36°F (Note 2)
(5) Pause time error	$\frac{TMx_3 - TM}{TMs} \times 100 (\%)$	Full-scale value		

Note 1: For digital timers, the set value Ts shall be optional.

Note 2: If no question arises from evaluation results, 13-35°C is acceptable.

Note 3: The measurement may be performed in other specified voltage ranges.

Note 4: The measurement may be performed in other specified temperature ranges.

TM: Average of measured values for operation time

Ts: Set value

TMs: Full-scale value. For digital timers, any arbitrary scale-value may be used.

Tmax: Maximum of measured values for operation time

Tmin: Minimum of measured values for operation time

TMx₁: Average of operation time at such voltage as maximizes deviation from TM in allowable voltage range.

TMx₂: Average of operation time at such temperature as maximizes deviation from TM in allowable temperature range.

TMx₃: Average of operation time at such pause time (in the range from the specified reset time to 1 hour) as maximizes deviation from TM.

• Functional Vibration Resistance

Means such a vibration as occurs in the range where the contact closed with that vibration during the use of the timer remains closed for the specified time (3 or 1 msec.) minimum.

• Destructive Vibration Resistance

Means such a vibration as occurs in the range where no part is damage with that vibration during the transportation or use of the timer and the operation characteristics are maintained.

• Functional Shock Resistance

Means such a shock as occurs in the range where the contact closed with that shock during the use of the timer remains closed for the specified time (1 ms) minimum.

• Destructive Shock Resistance

Means such a shock as occurs in the range where no part is damaged with that shock during the transportation or use of the timer and the operation characteristics are maintained.

• Mechanical life

Means the durability that is achieved when the control output is performed in the no-load state.

• Electrical life

Means the durability that is achieved when the specified voltage and current loads are individually applied to the control output while being turned ON and OFF. Generally, the life of the timer is represented by the number of times the control output is performed. When a load is connected to the control output, the term of "electrical life" is used. When no load is connected to the control output, the term of "mechanical life" is used. The electrical life is shorter than the mechanical life, and becomes longer as the load decreases. The life of the timer is made longer by connecting a relay or a similar part rather than directly switching a large load with the control output.

• Rated power consumption

Means the power that is consumed when the rated operation voltage is applied to the power circuit.
(Rated power consumption = rated voltage × current consumption)

• Rated control capacity

Means the reference value that is used to determine the performance of the switching part of the load. This value is represented by the combination of voltage and current.

• Contact resistance

Means the combined resistance that consists of the contact resistance between contacts, and the conductor resistance of pins and contact springs.

• Insulation resistance

Means the resistance between a contact or a conductive pin like the pin to which the operation voltage is applied, and a dead pin or a non-conductive metallic part like the time case, the base, or a retaining screw; or the resistance between contacts.

• Withstand voltage

Means the limit value that does not cause breakdown when high voltage is applied for one minute to the same location as measured for insulation resistance. The detectable leak current is normally 10 mA. In special cases, however, it may be 1mA or 3 mA.

• Withstand surge voltage

Means the limit value that shows the durability against momentary abnormal voltage resulting from lightning or switching a conductive load. The surge waveform is represented by the standard impulsive voltage waveform at ±(1.2 × 50) μs or ±(1 × 40) μs.

PRECAUTIONS IN USING THE TIMERS

Cautions for circuits

1. Protective circuit for timer contact

In the circuit that switches an inductive load, a contact failure may occur at a contact point due to surge or inrush current resulting from that switching. Therefore, it is recommended that the following protective circuit be used to protect the contact point.

Circuit	CR circuit (r: resistor c: capacitor)		Diode circuit	Varistor circuit
Application	AC DC	(see note.) Available	Available Available	Not available Available
Features/Notes	<p>If the load is a relay or solenoid, the release time lengthens. Effective when connected to both contacts if the power supply voltage is 24 or 48 V and the voltage across the load is 100 to 200 V.</p> <p>If the load is a timer, leakage current flows through the CR circuit causing faulty operation. Note: If used with AC voltage, be sure the impedance of the load is sufficiently smaller than that of the c and r.</p>		<p>The diode connected in parallel causes the energy stored in the coil to flow to the coil in the form of current and dissipates it as joule heat at the resistance component of the inductive load. This circuit further delays the release time compared to the CR circuit. (2 to 5 times the release time listed in the catalog)</p>	<p>Using the rated voltage characteristics of the varistor, this circuit prevents excessively high voltages from being applied across the contacts. This circuit also slightly delays the release time.</p>
Device Selection	<p>As a guide in selecting r and c, c: 0.5 to 1 μF per 1 A contact current r: 0.5 to 1 Ω per 1 V contact voltage Values vary depending on the properties of the load and variations in timer characteristics. Capacitor c acts to suppress the discharge the moment the contacts open. Resistor r acts to limit the current when the power is turned on the next time. Test to confirm. Use a capacitor with a breakdown voltage of 200 to 300 V. Use AC type capacitors (non-polarized) for AC circuits.</p>		<p>Use a diode with a reverse breakdown voltage at least 10 times the circuit voltage and a forward current at least as large as the load current. In electronic circuits where the circuit voltages reverse breakdown voltage of about 2 to 3 times the power supply voltage.</p>	—

2. Type of Load and Inrush Current

The type of load and its inrush current characteristics, together with the switching frequency are important factors which cause contact welding. Particularly for loads with inrush currents, measure the steady state current and inrush current and use a relay or magnet switch which provides an ample margin of safety. The table below shows the relationship between typical loads and their inrush currents.

Type of load	Inrush current
Resistive load	Steady state current
Solenoid load	10 to 20 times the steady state current
Motor load	5 to 10 times the steady state current
Incandescent lamp load	10 to 15 times the steady state current
Mercury lamp load	1 to 3 times the steady state current
Sodium vapor lamp load	1 to 3 times the steady state current
Capacitive load	20 to 40 times the steady state current
Transformer load	5 to 15 times the steady state current

When you want large load and long life of the timer, do not control the load direct with a timer. When the timer is designed to use a relay or a magnet switch, you can acquire the longer life of the timer.

3. Connection of input

The PM4H and LT4H series use power supply without a transformer (power and input terminals are not insulated). In connecting various kinds of input signals, therefore, use a power transformer in which the primary side is separated from the ungrounded secondary side as shown in Fig. A, for the power supply for a sensor and other input devices so that short-circuiting can be prevented.

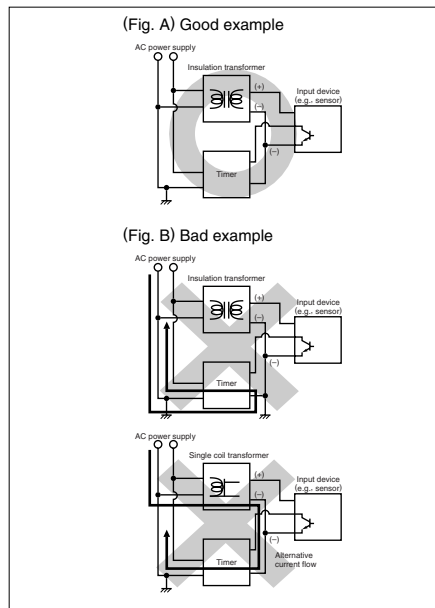

Do not use a single coil transformer (e.g., Sly-Duck). Otherwise, the internal circuit of the timer will be short-circuited as shown in Fig. B resulting in breakdown.

4. Long Continuous Current Flow

Long continuous current flow through the timer (approx. one month or longer) cause generation of heat internally, which degrade the electronic parts. Use the timer in combination with a relay and avoid long continuous current flow through the timer.

(1) When using contact output

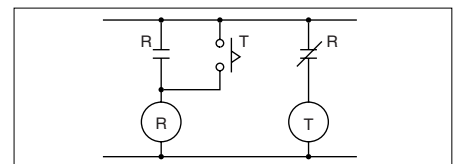

(2) When using non-contact output

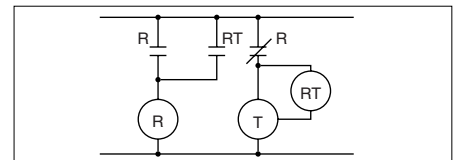

5. Leakage current

1) For connecting and disconnecting operating voltage to the timer, a circuit should be used, which will prevent the flow of leakage current. For example, a circuit for contact protection as shown in Fig. A. will permit leakage current flow through R and C, causing erroneous operation of the timer. Instead, the circuit shown in Fig. B should be used.

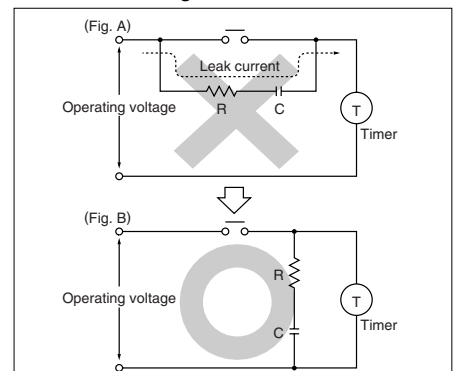

PRECAUTIONS IN USING THE TIMERS

2) If the timer is directly switched with a non-contact element, leak current may flow into the timer and cause it to malfunction.

6. Power off time

If the operation voltage for the timer is turned ON after the limit time operation is completed or before the limit time is reached, the Power off time longer than the timer restoration time must be secured.

7. Suicide circuit

If the timer is restored immediately after the specified time is reached, the circuit must be configured so that the restoration time of the timer can be secured sufficiently.

If the power circuit for the timer is turned OFF with the timer contact, a suicide circuit may be configured (Fig. A). In order to settle the problem with this potential suicide circuit, the circuit must be designed so that the timer is turned OFF after the self-retention circuit is completely released (Fig. B).

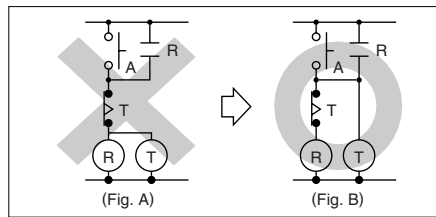

8. Electrical life

The electrical life varies depending on the load type, the switching phase, and the ambient atmosphere. In particular, the following cases require careful attention:

tion:

(1) If an AC load is switched in synchronized phases:

Locking or welding is liable to occur due to contact transposition. Check this with the actual system.

(2) If a load is switched very frequently: If a load which generates arcs when a contact is switched is turned ON and OFF very frequently, nitrogen and oxygen in air are combined due to arc energy and then HNO_3 is produced. This may corrode metallic materials.

The effective countermeasures include:

1. Using an arc-extinguishing circuit;
2. Decreasing the switching frequency; and
3. Decreasing the humidity in the ambient atmosphere.

Cautions for use (common for all models)

1. Pin connections

Correctly connect the pins while seeing the terminal layout/wiring diagram. In particular, the DC type, which has polarities, does not operate with the polarities connected reverse. Any incorrect connection can cause abnormal heating or ignition.

2. Connection to operation power supply

1) Supply voltage must be applied at a time through a switch, a relay, and other parts. If the voltage is applied gradually, the specified time may be reached regardless of its value or the power supply may not be reset.

2) The operation voltage for the DC type must be at the specified ripple percentage or less. The average voltage must fall within the allowable operation voltage range.

Rectification type	Ripple percentage
Single-phase, full-wave	Approx. 48%
Three-phase, full-wave	Approx. 4%
Three-phase, half-wave	Approx. 17%

Note: Refer to the ripple percentage of each timer.

3) Make sure that no induced voltage and residual voltage are applied between the power pins on the timer after the power switch is turned OFF.

(If the power line is wired in parallel with the high-voltage and motor lines, induced voltage may be produced between the power pins.)

3. Control output

1) The load for the control output must be used within the load capacity specified in the rated control capacity. If it is used exceeding the rated value, the life is greatly shortened.

2) The following connection might result in short circuit between the heteropolar contacts in the timer.

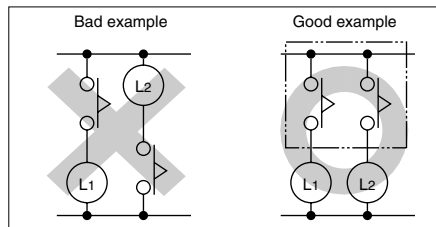

4. Installing the timer

1) To install the timer, use the dedicated pin bracket or socket (cap). Avoid connecting the pins on the timer by directly soldering them.

2) In order to maintain the characteristics, do not remove the timer cover (case).

5. Superimposed surge of power supply

For the superimposed surge of power supply, the standard waveform ($\pm 1.2 \times 50\mu\text{s}$ or $\pm 1 \times 40\mu\text{s}$) is taken as the standard value for surge-proof voltage. (The positive and negative voltages are applied each three or five times between the power pins.)

For the standard values for the PM4H, LT4H and S1DX type timers, see the respective items in "Cautions for use."

• Single-pole, full-wave voltage for surge waveform [$\pm(1.2 \times 50) \mu\text{s}$]

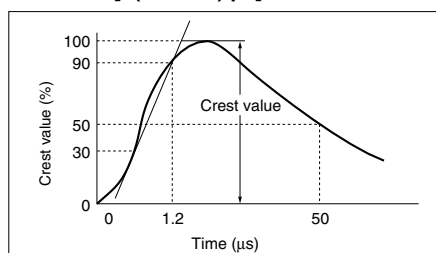

• Single-pole, full-wave voltage for surge waveform [$\pm(1 \times 40) \mu\text{s}$]

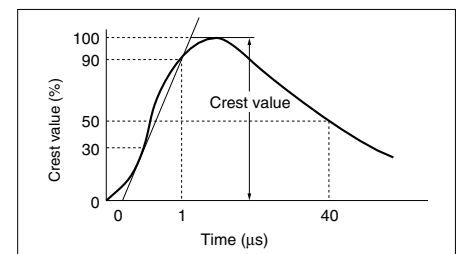

• PMH [$\pm(1 \times 40) \mu\text{s}$]

Voltage type	Surge voltage
AC type (Except for 24V AC)	4,000V
12V DC, 24V DC, 24V AC	500V
48V DC	1,000V
100 to 110V DC	2,000V

If external surge occurs exceeding the specified value, the internal circuit may break down. In this case, use a surge absorption element. The typical surge absorption elements include a varistor, a capacitor, and a diode. If a surge absorption element is used, use an oscilloscope to see whether or not the foreign surge exceeding the specified value appears.

6. Changing the set time

Do not change the set time when the limit time operation is in progress. However, this is possible only with the motor-driven type timer if the set time is shorter than the remaining time. For changing the set time on the digital timer (LT4H series), see the relevant item in "Cautions for use."

PRECAUTIONS IN USING THE TIMERS

7. Operating environment

1) Use the timer within the ambient temperature range from -10°C to $+50^{\circ}\text{C}$ ($+14^{\circ}\text{F}$ to $+122^{\circ}\text{F}$ ($+55^{\circ}\text{C}$ $+131^{\circ}\text{F}$ for the LT4H series) and at ambient humidity of 85% RH maximum.

2) Avoid using the timer in a location where inflammable or corrosive gas is generated, the timer is exposed to much dust and other foreign matter water or oil is splashed on the timer or vibrations or shocks are given to the timer.

3) The timer cover (case), the knobs, and the dials are made of polycarbonated resin. Therefore, prevent the timer from being exposed to organic solvents such as methyl alcohol, benzene, and thinner, strong acid substances such as

caustic soda, and ammonia and avoid using the timer in atmosphere containing any of those substances.

4) If the timer is used where noises are emitted frequently, separate the input signal elements (such as a sensor), the wiring for the input signal line, and the timer as far as possible from the noise source and the high power line containing noises.

8. Checking the actual load

In order to increase the reliability in the actual use, check the quality of the timer in the actual usage.

9. Others

1) If the timer is used exceeding the ratings (operation voltage and control capacity), the contact life, or any other

specified limit, abnormal heat, smoke, or ignition may occur.

2) If any malfunction of the timer is likely to affect human life and properties, give allowance to the rated values and performance values. In addition, take appropriate safety measures such as a duplex circuit from the viewpoint of product liabilities.

FOREIGN SPECIFICATIONS

TIMER

Products Name	Recognized by UL Standards		Certified by CSA Standards		Lloyd's Register Standards		Remarks	
	File No.	Recognized rating	File No.	Certified rating	File No.	Certified rating		
PM4S	E43149	5A250VAC PILOT DUTY C300	E43149 (C-UL)	5A250VAC PILOT DUTY C300	—	—		
PM4H-A PM4H-S PM4H-M PM4H-SD PM4H-W	E122222	5A250VAC PILOT DUTY C300	LR39291	5A250VAC PILOT DUTY C300	98/10004	5A 250V AC (resistive)		
PM4H-F	E122222	3A250VAC PILOT DUTY C300	LR39291	3A250VAC PILOT DUTY C300	98/10004	3A 250V AC (resistive)		
LT4H LT4H-L LT4H-W	E122222	5A250VAC PILOT DUTY C300 100mA30VDC	E122222 (C-UL)	5A250VAC PILOT DUTY C300 100mA30VDC	—	—		
QM4H	E43149	5A250VAC PILOT DUTY C300	E43149 (C-UL)	5A250VAC PILOT DUTY C300	—	—		
PMH	E59504	7A1/6HP125VAC 7A1/6HP250VAC 3A30VDC PILOT DUTY C300	LR39291	7A1/6HP125VAC 7A1/6HP250VAC 3A30VDC PILOT DUTY C300	88/10123	125V3.5A (COS $\phi \approx 0.4$) 250V2A (COS $\phi \approx 0.4$) 250V7A (COS $\phi \approx 1.0$)	"The standard models conform to the UL/CSA standard. (To place an order, you do not need to specify the tailing character [9] of each item number.)" The standard models conform to the LLOYD standard.	
MHP MHP-M	E59504	5A250VAC	LR39291	5A250VAC	88/10123	250V5A (COS $\phi \approx 1.0$)	"The standard models conform to the UL/CSA standard. (To place an order, you do not need to specify the tailing character [9] of each item number.)"	
S1DXM-A/M (Relay output)	2C	E122222	7A125VAC 6A250VAC 1/6HP125, 250VAC PILOT DUTY C300	LR39291	7A125VAC 6A250VAC 1/6HP125, 250VAC PILOT DUTY C300	98/10004	7A 250V AC (resistive)	
	4C	E122222	5A250VAC 1/10HP125, 250VAC PILOT DUTY C300	LR39291	5A250VAC 1/10HP125, 250VAC PILOT DUTY C300	98/10004	5A 250V AC (resistive)	
S1DX (Relay output)	2C	E122222	7A125VAC 6A250VAC 1/6HP125, 250VAC PILOT DUTY C300	LR39291	7A125VAC 6A250VAC 1/6HP125, 250VAC PILOT DUTY C300	98/10004	7A 250V AC (resistive)	
	4C	E122222	5A250VAC 1/10HP125, 250VAC PILOT DUTY C300	LR39291	5A250VAC 1/10HP125, 250VAC PILOT DUTY C300	98/10004	5A 250V AC (resistive)	
PM5S-A PM5S-S PM5S-M	E59504 (C-UL)	5A250VAC PILOT DUTY C300	E59504 (C-UL)	5A250VAC PILOT DUTY C300	—	—		

Accessories

Products Name	Recognized by UL Standards		Certified by CSA Standards		Lloyd's Register Standards		Remarks
	File No.	Recognized rating	File No.	Certified rating	File No.	Certified rating	
Common mounting tracks for timers	E59504	10A250VAC AT8-RFD (AT78039) 7A250VAC AT8-DF8L (ATA48211) 8P cap was an approved as an option. AD8-RC (AD8013)	LR39291	10A250VAC AT8-RFD (AT78039) 7A250VAC AT8-DF8L (ATA48211) 8P cap was an approved as an option. AD8-RC (AD8013)	—	—	
	E148103	AT8-DF8K (ATC180031) AT8-DF11K (ATC180041) AT8-R8K (AT78041) AT8-R11K (AT78051)	E148103 (C-UL)	AT8-DF8K (ATC180031) AT8-DF11K (ATC180041) AT8-R8K (AT78041) AT8-R11K (AT78051)	—	—	

FOREIGN SPECIFICATIONS

Counters

Product name	UL recognized		CSA certified		Remarks
	File No.	Approved ratings	File No.	Approved ratings	
LC4H LC4H-L LC4H-S	E122222	5A250V AC PILOT DUTY C300 100mA 30V DC	E122222 (C-UL)	5A250V AC PILOT DUTY C300 100mA 30V DC	
LC4H-W	E122222	3A250V AC PILOT DUTY C300 100mA 30V DC	E122222 (C-UL)	3A250V AC PILOT DUTY C300 100mA 30V DC	
LC2H	E122222	24-240 V AC/DC 4.5-30 V DC 3 V DC	E122222 (C-UL)	24-240 V AC/DC 4.5-30 V DC 3 V DC	
LC2H preset	E122222	24-240 V AC/DC 4.5-30 V DC 3 V DC	E122222 (C-UL)	24-240 V AC/DC 4.5-30 V DC 3 V DC	

Hour Meters

Product name	UL recognized		CSA certified		Remarks
	File No.	Approved ratings	File No.	Approved ratings	
TH13 · TH23 series	E42876	115-120, 220, 240V AC	LR39291	115-120, 220, 240V AC	• For UL-recognized and CSA-certified products, specify "U" at the end of the part No.
TH14 · TH24 series	E42876	12, 24, 48, 100, 110, 115-120, 200, 220, 240V AC	LR39291	12, 24, 48, 100, 110, 115-120, 200, 220, 240V AC	• Only black panel-mounting type UL-recognized and CSA-certified. • For UL-recognized and CSA-certified products, specify "U" at the end of the product code. • Panel-mounting silver type not UL-recognized nor CSA-certified.
TH63 · 64 series	E42876	12, 24, 48, 100, 110, 115-120, 200, 220, 240V AC	LR39291	12, 24, 48, 100, 110, 115-120, 200, 220, 240V AC	• Standard products are UL-recognized and CSA-certified.
LH2H	E122222	24-240 V AC/DC 4.5-30 V DC 3 V DC	E122222 (C-UL)	24-240 V AC/DC 4.5-30 V DC 3 V DC	• Standard products are UL-recognized and CSA-certified.
LH2H preset	E122222	24-240 V AC/DC 4.5-30 V DC 3 V DC	E122222 (C-UL)	24-240 V AC/DC 4.5-30 V DC 3 V DC	• Standard products are UL-recognized and CSA-certified.
TH8 series	E42876	12 V DC 24 V DC	E42876 (C-UL)	12 V DC 24 V DC	• Standard products are UL-recognized and CSA-certified.

Accessories

Product name	UL-recognized		CSA certified		Remarks
	File No.	Rating	File No.	Rating	
Common counter fixtures	E59504	10A250V AC AT8-RFD (AT78039) 7A250V AC AT8-DF8L (ATA48211) 8P cap CSA-certified as option. AD8-RC (AD8013)	LR26550	10A250V AC AT8-RFD (AT78039) 7A250V AC AT8-DF8L (ATA48211) 8P cap UL-listed as option. AD8-RC(AD8013)	
	E148103	AT8-DF8K (ATC180031) AT8-DF11K (ATC180041) AT8-R8K (AT78041) AT8- R11K (AT78051)	E148103 (C-UL)	AT8-DF8K (ATC180031) AT8-DF11K (ATC180041) AT8-R8K (AT78041) AT8- R11K (AT78051)	

CE MARKINGS OVERVIEW

Counter, Hour Meter conforming to EN/IEC standards

The Timer, Counter, Hour Meter shown below conform to both EN and IEC standards, and may display the CE markings.

Product classification	Product name	EMC directives	Low-voltage directives
Timers	LT4H	EN 61000-6-4/EN 61000-6-2	EN 61812-1
	LT4H-L	EN 61000-6-4/EN 61000-6-2	EN 61812-1
	LT4H-W	EN 61000-6-4/EN 61000-6-2	EN 61812-1
	PM4H	EN 61000-6-4/EN 61000-6-2	EN 61812-1
	S1DX	EN 61000-6-4/EN 61000-6-2	EN 61812-1
	S1DXM-A/M	EN 61000-6-4/EN 61000-6-2	EN 61812-1
	PM4S	EN 61000-6-4/EN 61000-6-2	EN 61812-1
	PM5S	EN 61000-6-4/EN 61000-6-2	EN 61812-1
Time Switch	QM4H	EN 61000-6-4/EN 61000-6-2	EN 61010-1
	A-TB72	EN 61000-6-4/EN 61000-6-2	EN 61812-1
Counters	A-TB72Q	EN 61000-6-4/EN 61000-6-2	EN 61812-1
	LC4H	EN 61000-6-4/EN 61000-6-2	EN 61812-1
	LC4H-L	EN 61000-6-4/EN 61000-6-2	EN 61812-1
	LC4H-S	EN 61000-6-4/EN 61000-6-2	EN 61812-1
	LC4H-W	EN 61000-6-4/EN 61000-6-2	EN 61812-1
Hour Meters	LC2H	EN 61000-6-4/EN 61000-6-2	EN 61010-1
	LC2H preset	EN 61000-6-4/EN 61000-6-2	—
	TH13	EN 61000-6-4/EN 61000-6-2	EN 61010-1
	TH23	EN 61000-6-4/EN 61000-6-2	EN 61010-1
	TH14	EN 61000-6-4/EN 61000-6-2	EN 61010-1
	TH24	EN 61000-6-4/EN 61000-6-2	EN 61010-1
	TH40	EN 61000-6-4/EN 61000-6-2	EN 61010-1
	TH50	EN 61000-6-4/EN 61000-6-2	EN 61010-1
	TH63	EN 61000-6-4/EN 61000-6-2	EN 61010-1
	TH64	EN 61000-6-4/EN 61000-6-2	EN 61010-1
	LH2H	EN 61000-6-4/EN 61000-6-2	EN 61010-1
LH2H preset	EN 61000-6-4/EN 61000-6-2	—	
TH8	EN 61000-6-4/EN 61000-6-2	—	

What are EN standards?

An abbreviation of Norme Europeenne (in French), and called European Standards in English. Approval is by vote among the CEN/CENELEC member countries, and is a unified standards limited to EU member countries, but the contents conform to the international ISO/IEC standards.

If the relevant EN standard does not exist, it is necessary to obtain approval based on the relevant IEC standard or, if the relevant IEC standard does not exist, the relevant standard from each country, such as VDE, BS, SEMKO, and so forth.

CE markings and EC directives

The world's largest single market, the European Community (EC) was born on 1 January 1993 (changing its name to EU in November 1993. It is now always expressed as EU, apart from EC directives.) EU member country products have always had their quality and safety guaranteed according to the individual standards of each member country. However, the standards of each country being different prevented the free flow of goods within the EU. For this reason, in order to eliminate non-tariff barriers due to these standards, and to maximize the merits of EU unification, the EC directives were issued concomitant to the birth of the EU.

The EN standards were established as universal EU standards in order to facilitate EU directives. These standards were merged with the international IEC standards and henceforth reflect the standards in all countries. Also, the CE markings show that products conform to EC directives, and guarantee the free flow of products within the EC.

Appropriate EC directives for control equipment products

The main EC directives that are to do with machinery and electrical equipment are the machinery directive, the EMC directive, the low voltage directive, and the telecom directive. Although these directives have already been issued, the date of their enactment is different for each one. The machinery directive was 1 January 1995. The EMC directive was 1 January 1996, and the low voltage directive was enacted from 1 January 1997. The telecom directive was established by the separate CTR (Common Technology References.)