

High switching capacity
1a/1c 30A power relays

JT-N RELAYS



PCB type



TMP type

FEATURES

- High switching capacity — 30 A for 1 Form A
- 2 contact arrangements — 1 Form A or 1 Form C
- “TMP” types available
- UL, CSA recognized
- Class F type standard

TYPICAL APPLICATIONS

- Air conditioner
- Heating & ventilation
- Home appliance

Compliance with RoHS Directive

ORDERING INFORMATION

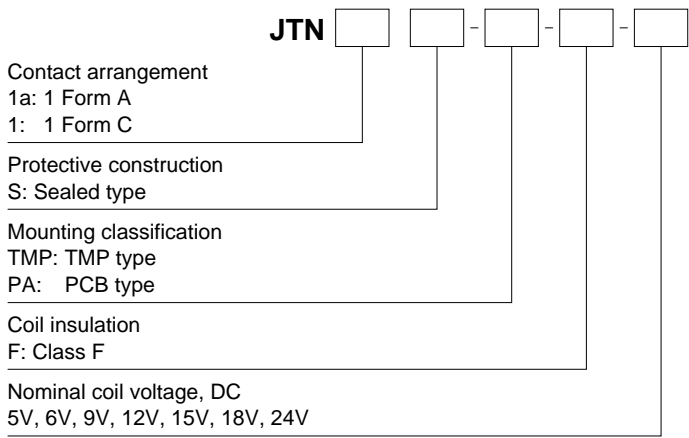

Note: Certified by UL and CSA

TYPES

1. 1 Form A Sealed type

Nominal coil voltage	Part No.	
	PCB type	TMP type
5V DC	JTN1aS-PA-F-DC5V	JTN1aS-TMP-F-DC5V
6V DC	JTN1aS-PA-F-DC6V	JTN1aS-TMP-F-DC6V
9V DC	JTN1aS-PA-F-DC9V	JTN1aS-TMP-F-DC9V
12V DC	JTN1aS-PA-F-DC12V	JTN1aS-TMP-F-DC12V
15V DC	JTN1aS-PA-F-DC15V	JTN1aS-TMP-F-DC15V
18V DC	JTN1aS-PA-F-DC18V	JTN1aS-TMP-F-DC18V
24V DC	JTN1aS-PA-F-DC24V	JTN1aS-TMP-F-DC24V

Standard packing: PCB type: Carton: 50 pcs.; Case: 500 pcs.
TMP type: Carton: 50 pcs.; Case: 300 pcs.

JT-N

2. 1 Form C Sealed type

Nominal coil voltage	Part No.	
	PCB type	TMP type
5V DC	JTN1S-PA-F-DC5V	JTN1S-TMP-F-DC5V
6V DC	JTN1S-PA-F-DC6V	JTN1S-TMP-F-DC6V
9V DC	JTN1S-PA-F-DC9V	JTN1S-TMP-F-DC9V
12V DC	JTN1S-PA-F-DC12V	JTN1S-TMP-F-DC12V
15V DC	JTN1S-PA-F-DC15V	JTN1S-TMP-F-DC15V
18V DC	JTN1S-PA-F-DC18V	JTN1S-TMP-F-DC18V
24V DC	JTN1S-PA-F-DC24V	JTN1S-TMP-F-DC24V

Standard packing: PCB type: Carton: 50 pcs.; Case: 500 pcs.
 TMP type: Carton: 50 pcs.; Case: 300 pcs.

RATING

1. Coil data

Nominal coil voltage	Pick-up voltage (at 20°C 68°F)	Drop-out voltage (at 20°C 68°F)	Nominal operating current [±10%] (at 20°C 68°F)	Coil resistance [±10%] (at 20°C 68°F)	Nominal operating power	Max. applied voltage (at 20°C 68°F)
5V DC	75%V or less of nominal voltage (Initial)	10%V or more of nominal voltage (Initial)	161.3mA	31Ω	800mW	6 V
6V DC			133.3mA	45Ω		7.2V
9V DC			89.1mA	101Ω		10.8V
12V DC			66.6mA	180Ω		14.4V
15V DC			53.4mA	281Ω		18 V
18V DC			44.4mA	405Ω		21.6V
24V DC			33.3mA	720Ω		28.8V

2. Specifications

Characteristics	Item	Specifications	
Contact	Contact material	AgSnO ₂ type	
	Arrangement	1 Form A 1 Form C	
	Contact resistance (Initial)	Max. 50 mΩ (By voltage drop 6 V DC 1A)	
Rating	Nominal switching capacity (resistive load)	20A 277V AC N.C.: 10A 277V AC, N.O.: 20A 277V AC	
	Max. switching power (resistive load)	8,310VA (30A 277V AC) N.C.: 2,770VA, N.O.: 5,540VA	
	Max. switching voltage	277V AC	
	Max. switching current	30A N.C.: 10A, N.O.: 20A	
	Nominal operating power	Approx. 800mW	
Electrical characteristics	Min. switching capacity (reference value)*1	100mA, 5V DC	
	Insulation resistance (Initial)	Min. 100MΩ (at 500V DC) Measurement at same location as "Breakdown voltage" section.	
	Breakdown voltage (Initial)	Between open contacts	1,200 Vrms for 1 min. (Detection current: 10 mA)
		Between contact and coil	2,500 Vrms for 1 min. (Detection current: 10 mA)
	Surge breakdown voltage*2 (Between contact and coil) (Initial)	—	
	Operate time (at nominal voltage) (at 20°C 68°F)	Max. 20 ms (excluding contact bounce time.)	
Release time (at nominal voltage) (at 20°C 68°F)	Max. 10 ms (excluding contact bounce time) (Without diode)		
Mechanical characteristics	Shock resistance	Functional	Min. 98 m/s ² (Half-wave pulse of sine wave: 11 ms; detection time: 10μs.)
		Destructive	Min. 980 m/s ² (Half-wave pulse of sine wave: 6 ms.)
	Vibration resistance	Functional	10 to 55 Hz at double amplitude of 1.5 mm (Detection time: 10μs.)
		Destructive	10 to 55 Hz at double amplitude of 2 mm
Expected life	Mechanical	Min. 1×10 ⁷	
	Electrical (at 20 times/min.)*3	Min. 1×10 ⁵ (20A 277V AC at resistive load) N.O.: Min. 1×10 ⁵ (20A 277V AC at resistive load) N.C.: Min. 1×10 ⁵ (10A 277V AC at resistive load)	
Conditions	Conditions for operation, transport and storage*4	Ambient temperature: -55°C to +85°C -67°F to +185°F, Humidity: 5 to 85% R.H. (Not freezing and condensing at low temperature)	
	Max. operating speed	20 times/min. (at nominal switching capacity)	
Unit weight		PCB type: Approx. 25 g .88 oz TMP type: Approx. 30 g 1.06 oz	

* Specifications will vary with foreign standards certification ratings.

Notes: *1. This value can change due to the switching frequency, environmental conditions, and desired reliability level, therefore it is recommended to check this with the actual load.

*2. Wave is standard shock voltage of ±1.2×50μs according to JEC-212-1981

*3. In order to obtain the full rated life cycles, the relay should be properly vented by removing the vent nib. More detail, please look at caution for NOTES.

*4. The upper limit of the ambient temperature is the maximum temperature that can satisfy the coil temperature rise value. Refer to Usage, transport and storage conditions in NOTES.

REFERENCE DATA

1. Change of rate of pick-up and drop-out voltage (at 20°C 68°F)
 Sample: JTN1S-TMP-F-DC24V (6 pcs.)

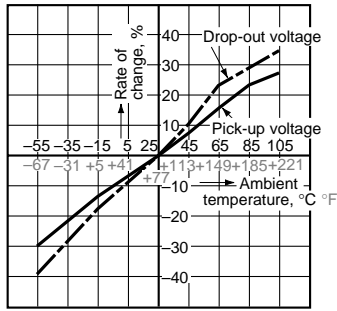

2. Operate & release time (at 20°C 68°F)
 Sample: JTN1S-TMP-F-DC24V (6 pcs.)

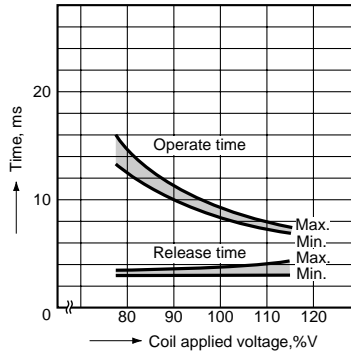

3. Operate & release time (at 20°C 68°F)
 Sample: JTN1aS-PA-F-DC24V (6 pcs.)

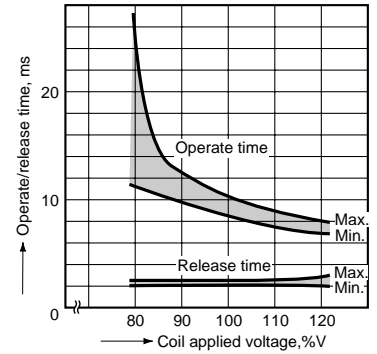

4. Distribution frequency of pick-up voltage (at 20°C 68°F)
 Sample: JTN1S-TMP-F-DC12V (30 pcs.)

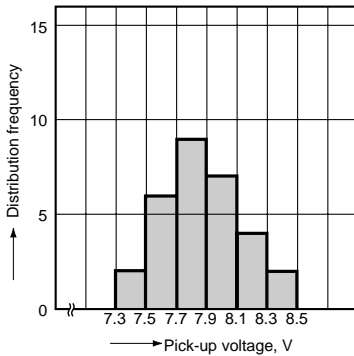

5. Distribution frequency of drop-out voltage (at 20°C 68°F)
 Sample: JTN1S-TMP-F-DC12V (30 pcs.)

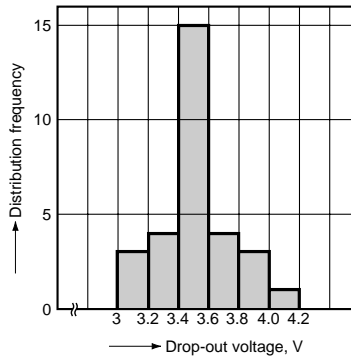

6.-(1) Coil temperature rise (TMP type)*
 Ambient temperature: 20°C 68°F
 Sample: JTN1aS-TMP-F-DC12V (6 pcs.)

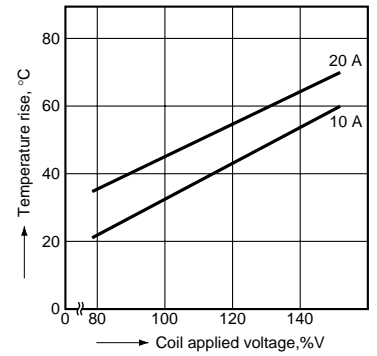

* Coil temperature rise of sealed types are same as data of the dust cover type.

Ambient temperature: 55°C 131°F
 Sample: JTN1aS-TMP-F-DC12V (6 pcs.)

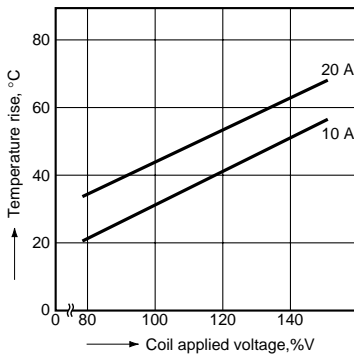

Ambient temperature: 85°C 185°F
 Sample: JTN1aS-TMP-F-DC12V (6 pcs.)

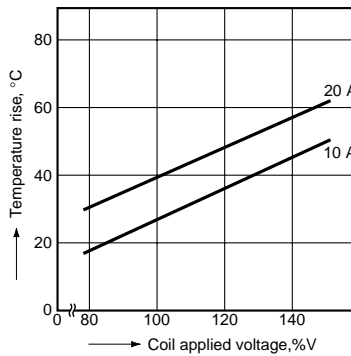

Ambient temperature: 105°C 221°F
 Sample: JTN1aS-TMP-F-DC12V (6 pcs.)

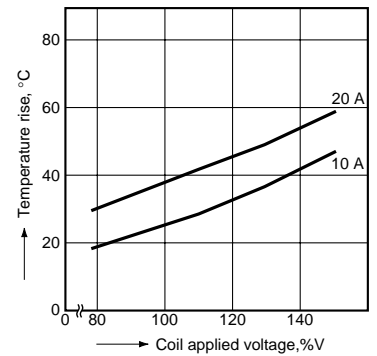

JT-N

DIMENSIONS (mm inch)

The CAD data of the products with a **CAD Data** mark can be downloaded from: <http://panasonic-electric-works.net/ac>

1. PCB type

CAD Data

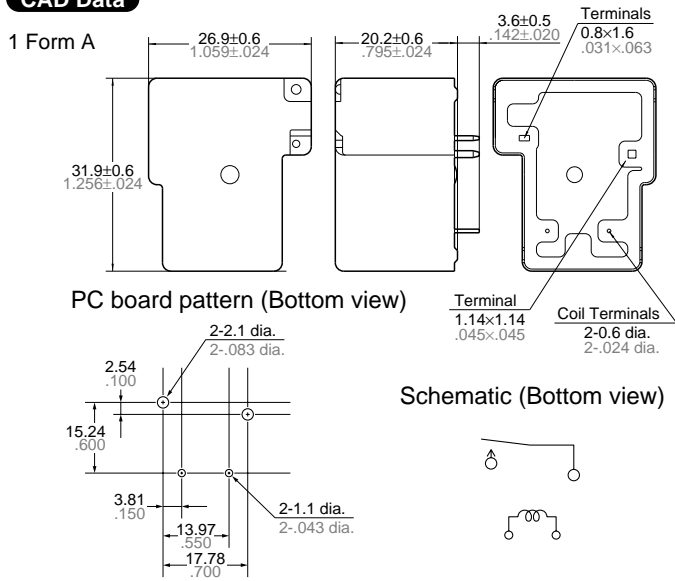

CAD Data

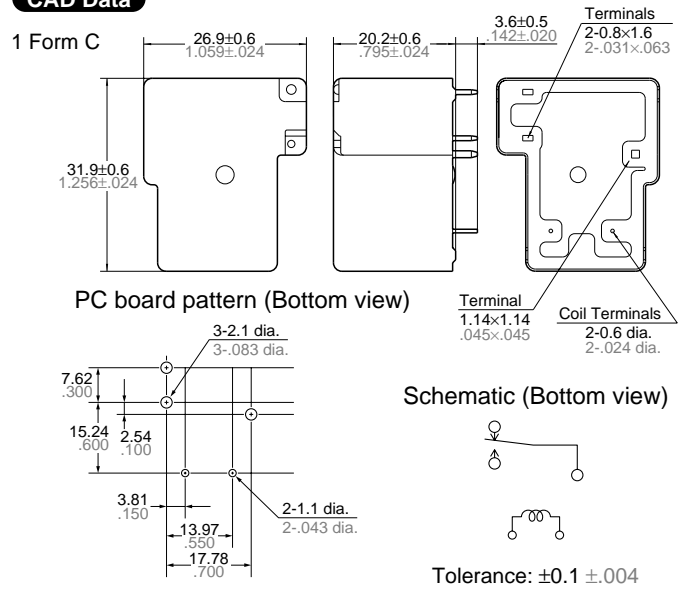

2. TMP type

CAD Data

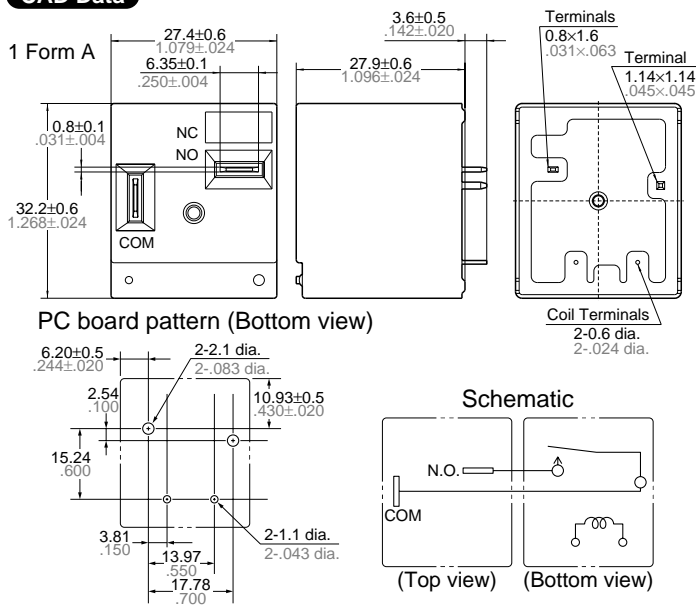

CAD Data

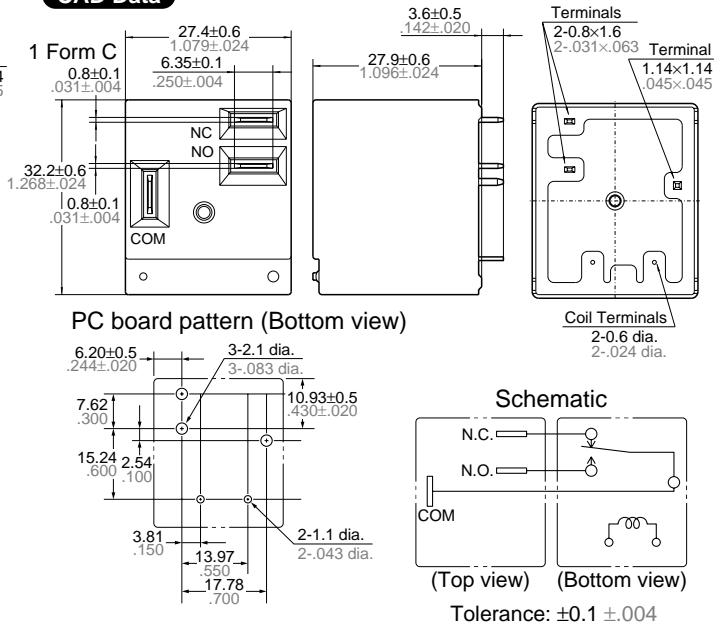

SAFETY STANDARDS

Item	UL/C-UL (Recognized)	
	File No.	Contact rating
1 Form A	E43028	30A 277V AC, 30A 28V DC, 2HP 250V AC
1 Form C	N.O.	20A 277V AC, 20A 28V DC, 2HP 250V AC
	N.C.	10A 277V AC, 10A 28V DC, ½HP 250V AC

* CSA standard: Certified by C-UL

NOTES

1. Electrical life

In order to obtain the full rated life cycles, the relay should be properly vented by removing the vent nib after the soldering/washing process.

• PCB type

• TMP type

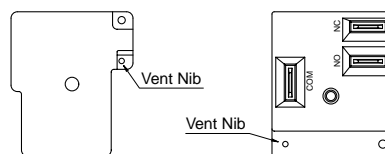

For Cautions for Use.