

GX SERIES

Compact Inductive Proximity Sensor **Amplifier Built-in**

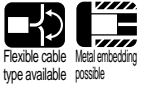

High functionality together with robust housing and flexible cable

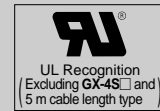

Miniature

GX-3S□ is an amplifier built-in inductive proximity sensor having a diameter of just $\phi 3.8$ mm $\phi 0.150$ in.

GX-3S□

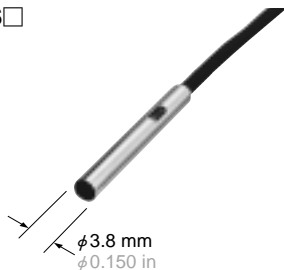

Various applications

The **GX** series can be used for various applications because of its wide supply voltage range, open-collector transistor output, sufficient output capacity and IP67 protection.

Operation indicator

All models of the **GX** series are equipped with an operation indicator for easy adjustment and maintenance.

Long sensing range

The non-shielded type (**GX-8ML□**) has twice the sensing range of the shielded type (**GX-8M□**), although having the same size. Hence, it allows margin against sensing distance variations.

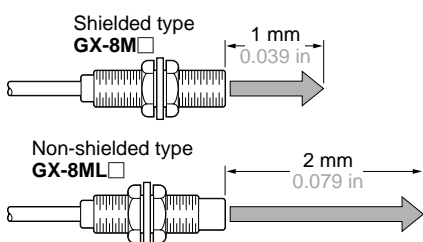

Robust housing

The **GX-4S** uses a robust stainless steel housing. The tightening torque can be 0.58 N·m or less.

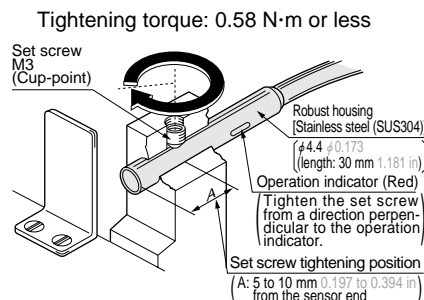

Ten times greater bending durability

The bending durability of the cable to repeated bending has been increased tenfold by using special alloy cores for the cable.

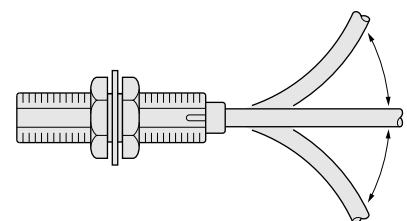

APPLICATIONS

Sensing screws on cassette

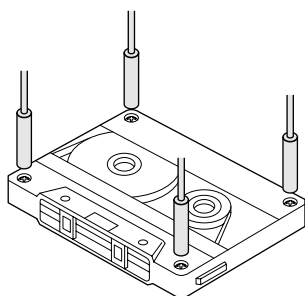

Sensing the punch of a die

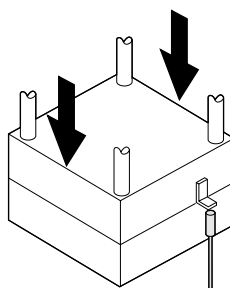

Counting parts

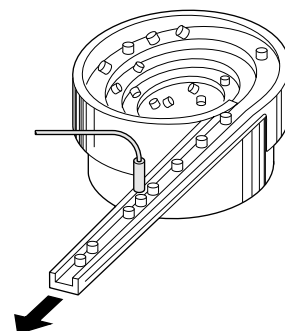

ORDER GUIDE

Type	Appearance (mm in)	Sensing range (Note)	Model No.	Supply voltage	Output	Output operation
Shielded type	<p>Non-threaded type Robust housing type</p>	<p>Maximum operation distance</p> <p>0.8 mm 0.031 in</p> <p>(0 to 0.6 mm 0 to 0.024 in)</p> <p>Stable sensing range</p>	GX-3S	12 to 24 V DC ± 10 %	NPN open-collector transistor	Normally open
			GX-3SB			Normally closed
		<p>0.8 mm 0.031 in</p> <p>(0 to 0.6 mm 0 to 0.024 in)</p>	GX-4S			Normally open
			GX-4SB			Normally closed
		<p>1 mm 0.039 in</p> <p>(0 to 0.8 mm 0 to 0.031 in)</p>	GX-5S			Normally open
			GX-5SB			Normally closed
Non-shielded type	<p>Threaded type</p>	<p>0.8 mm 0.031 in</p> <p>(0 to 0.6 mm 0 to 0.024 in)</p>	GX-5M	12 to 24 V DC ± 10 %	Normally open	
			GX-5MB		Normally closed	
		<p>1 mm 0.039 in</p> <p>(0 to 0.8 mm 0 to 0.031 in)</p>	GX-8M		Normally open	
			GX-8MB		Normally closed	
	<p>2 mm 0.079 in</p> <p>(0 to 1.6 mm 0 to 0.063 in)</p>	GX-8ML	10 to 30 V DC	Normally open		
		GX-8MLB		Normally closed		

Note: The maximum operation distance stands for the maximum distance for which the sensor can detect the standard sensing object.
The stable sensing range stands for the sensing range for which the sensor can stably detect the standard sensing object even if there is an ambient temperature drift and/or supply voltage fluctuation.

Amplifier Built-in

GL-18H/18HL

GL-8/8U

GL-6

GL-N12

GL-X

GA-10/GH

ORDER GUIDE

Flexible cable type and 5 m 16.404 ft cable length type

Flexible cable type and 5 m 16.404 ft cable length type (standard: 3 m 9.843 ft) are also available.

• Table of model Nos.

Type		Standard	Flexible cable type	5 m 16.404 ft cable length type	Flexible cable & 5 m 16.404 ft cable length type
Shielded type	Non-threaded type	GX-3S	GX-3S-R	GX-3S-C5	GX-3S-R-C5
		GX-3SB	GX-3SB-R	GX-3SB-C5	GX-3SB-R-C5
		GX-4S	GX-4S-R	GX-4S-C5	GX-4S-R-C5
		GX-4SB	GX-4SB-R	_____	_____
		GX-5S	GX-5S-R	GX-5S-C5	GX-5S-R-C5
	Threaded type	GX-5SB	GX-5SB-R	GX-5SB-C5	_____
		GX-5M	GX-5M-R	GX-5M-C5	GX-5M-R-C5
		GX-5MB	GX-5MB-R	GX-5MB-C5	_____
		GX-8M	GX-8M-R	GX-8M-C5	GX-8M-R-C5
		GX-8MB	GX-8MB-R	GX-8MB-C5	GX-8MB-R-C5
Non-shielded type		GX-8ML	_____	GX-8ML-C5	_____
		GX-8MLB	_____	GX-8MLB-C5	_____

Accessories

- **MS-SS3** (Sensor mounting bracket for **GX-3S** type)
- **MS-SS5** (Sensor mounting bracket for **GX-5S** type)
- **MS-SS3-2** (C bracket for **GX-3S** type)

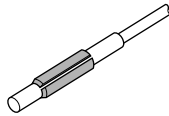
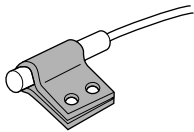

By using the C bracket, the applicable tightening force can be doubled.

SPECIFICATIONS

Non-threaded type

Item	Type Model No.	Shielded type											
		Flexible cable				Flexible cable				Flexible cable			
		GX-3S	GX-3SB	GX-3S-R	GX-3SB-R	GX-4S	GX-4SB	GX-4S-R	GX-4SB-R	GX-5S	GX-5SB	GX-5S-R	GX-5SB-R
Max. operation distance (Note 1)		0.8 mm 0.031 in ± 15 %								1 mm 0.039 in ± 15 %			
Stable sensing range (Note 1)		0 to 0.6 mm 0 to 0.024 in								0 to 0.8 mm 0 to 0.031 in			
Standard sensing object		Iron sheet 5 × 5 × t 1 mm 0.197 × 0.197 × t 0.039 in								Iron sheet 6 × 6 × t 1 mm 0.236 × 0.236 × t 0.039 in			
Hysteresis		15 % or less of operation distance											
Repeatability		20 μm 0.787 mil or less								8 μm 0.315 mil or less			
Supply voltage		12 to 24 V DC ± 10 % Ripple P-P 10 % or less								10 to 30 V DC Ripple P-P 10 % or less			
Current consumption		15 mA or less											
Output		NPN open-collector transistor • Maximum sink current: 50 mA • Applied voltage: 30 V DC or less (between output and 0 V) • Residual voltage: 0.4 V or less (at 50 mA sink current)								NPN open-collector transistor • Maximum sink current: 200 mA (Note 2) • Applied voltage: 30 V DC or less (between output and 0 V) • Residual voltage: 1.5 V or less (at 200 mA sink current) 0.4 V or less (at 50 mA sink current)			
	Utilization category	DC-12 or DC-13											
	Output operation	Normally open	Normally closed	Normally open	Normally closed	Normally open	Normally closed	Normally open	Normally closed	Normally open	Normally closed	Normally open	Normally closed
Short-circuit protection		Incorporated								Incorporated			
Max. response frequency		1 kHz								1.5 kHz			
Operation indicator		Red LED (lights up when the output is ON)											
Environmental resistance	Pollution degree	3 (Industrial environment)											
	Protection	IP67 (IEC)											
	Ambient temperature	− 25 to + 70 °C − 13 to + 158 °F, Storage: − 25 to + 80 °C − 13 to + 176 °F											
	Ambient humidity	35 to 95 % RH, Storage: 35 to 95 % RH								35 to 85 % RH, Storage: 35 to 95 % RH			
	EMC	EN 50081-2, EN 50082-2, EN 60947-5-2											
	Voltage withstandability	500 V AC for one min. between all supply terminals connected together and enclosure											
	Insulation resistance	5 MΩ, or more, with 250 V DC megger between all supply terminals connected together and enclosure								50 MΩ, or more, with 500 V DC megger between all supply terminals connected together and enclosure			
	Vibration resistance	10 to 55 Hz frequency, 1.5 mm 0.059 in amplitude in X, Y and Z directions for two hours each											
Sensing range variation	Temperature characteristics	Over ambient temperature range − 25 to + 70 °C − 13 to + 158 °F: Within ± 20 % of sensing range at + 20 °C + 68 °F								Over ambient temperature range − 25 to + 70 °C − 13 to + 158 °F: Within ± 15 % of sensing range at + 20 °C + 68 °F			
	Voltage characteristics	Within ± 2 % for ± 10 % fluctuation of the supply voltage								Within ± 2.5 % for ± 15 % fluctuation of the supply voltage			
Material		Enclosure: Stainless steel (SUS304), Resin part: TPX								Enclosure: Brass (Nickel plated) Resin part: ABS			
Cable		0.08 mm ² 3-core oil, heat and cold resistant cabtyre cable, 3 m 9.843 ft long	0.1 mm ² 3-core flexible, oil and heat resistant cabtyre cable, 3 m 9.843 ft long	0.08 mm ² 3-core oil, heat and cold resistant cabtyre cable, 3 m 9.843 ft long	0.1 mm ² 3-core flexible, oil and heat resistant cabtyre cable, 3 m 9.843 ft long	0.14 mm ² 3-core oil, heat and cold resistant cabtyre cable, 3 m 9.843 ft long	0.15 mm ² 3-core flexible, oil and heat resistant cabtyre cable, 3 m 9.843 ft long						
Cable extension		Extension up to total 100 m 328.084 ft is possible with 0.3 mm ² , or more, cable.											
Weight		30 g approx.								55 g approx.			
Accessories		MS-SS3 (Sensor mounting bracket): 1 pc. MS-SS3-2 (C bracket): 1 pc.								MS-SS5 (Sensor mounting bracket): 1 pc.			

Notes: 1) The maximum operation distance stands for the maximum distance for which the sensor can detect the standard sensing object.
The stable sensing range stands for the sensing range for which the sensor can stably detect the standard sensing object even if there is an ambient temperature drift and/or supply voltage fluctuation.

2) The maximum sink current varies depending on the ambient temperature. Refer to 'I/O CIRCUIT AND WIRING DIAGRAMS' (p.749) for details.

SPECIFICATIONS

Threaded type

Item	Type Model No.	Shielded type								Non-shielded type	
		Flexible cable				Flexible cable				GX-8ML	GX-8MLB
		GX-5M	GX-5MB	GX-5M-R	GX-5MB-R	GX-8M	GX-8MB	GX-8M-R	GX-8MB-R		
Max. operation distance (Note 1)		0.8 mm 0.031 in ± 15 %				1 mm 0.039 in ± 15 %				2 mm 0.079 in ± 15 %	
Stable sensing range (Note 1)		0 to 0.6 mm 0 to 0.024 in				0 to 0.8 mm 0 to 0.031 in				0 to 1.6 mm 0 to 0.063 in	
Standard sensing object		Iron sheet 5 × 5 × t 1 mm 0.197 × 0.197 × t 0.039 in				Iron sheet 8 × 8 × t 1 mm 0.315 × 0.315 × t 0.039 in				Iron sheet 12 × 12 × t 1 mm 0.472 × 0.472 × t 0.039 in	
Hysteresis		15 % or less of operation distance				10 % or less of operation distance					
Repeatability		20 μm 0.787 mil or less				8 μm 0.315 mil or less				40 μm 1.575 mil or less	
Supply voltage		12 to 24 V DC ± 10 % Ripple P-P 10 % or less				10 to 30 V DC Ripple P-P 10 % or less					
Current consumption		15 mA or less									
Output		NPN open-collector transistor • Maximum sink current: 50 mA • Applied voltage: 30 V DC or less (between output and 0V) • Residual voltage: 0.4 V or less (at 50 mA sink current)				NPN open-collector transistor • Maximum sink current: 200 mA (Note 2) • Applied voltage: 30 V DC or less (between output and 0 V) • Residual voltage: 1.5 V or less (at 200 mA sink current) 0.4 V or less (at 50 mA sink current)					
	Utilization category	DC-12 or DC-13									
	Output operation	Normally open	Normally closed	Normally open	Normally closed	Normally open	Normally closed	Normally open	Normally closed	Normally open	Normally closed
	Short-circuit protection					Incorporated					
Max. response frequency		1 kHz								500 Hz	
Operation indicator		Red LED (lights up when the output is ON)									
Environmental resistance	Pollution degree	3 (Industrial environment)									
	Protection	IP67 (IEC)									
	Ambient temperature	− 25 to + 70 °C − 13 to + 158 °F, Storage: − 25 to + 80°C − 13 to + 176 °F									
	Ambient humidity	35 to 95 % RH, Storage: 35 to 95 % RH				35 to 85 % RH, Storage: 35 to 95 % RH					
	EMC	EN 50081-2, EN 50082-2, EN 60947-5-2									
	Voltage withstandability	500 V AC for one min. between all supply terminals connected together and enclosure									
	Insulation resistance	5 MΩ, or more, with 250 V DC megger between all supply terminals connected together and enclosure				50 MΩ, or more, with 500 V DC megger between all supply terminals connected together and enclosure					
	Vibration resistance	10 to 55 Hz frequency, 1.5 mm 0.059 in amplitude in X, Y and Z directions for two hours each									
Sensing range variation	Temperature characteristics	Over ambient temperature range − 25 to + 70 °C − 13 to + 158 °F: Within ± 20 % of sensing range at + 20 °C + 68 °F				Over ambient temperature range − 25 to + 70 °C − 13 to + 158 °F: Within $\pm 15\%$ % of sensing range at + 20 °C + 68 °F					
	Voltage characteristics	Within ± 2 % for ± 10 % fluctuation of the supply voltage				Within ± 2.5 % for ± 15 % fluctuation of the supply voltage					
Material		Enclosure: Brass (Nickel plated) Resin part: TPX				Enclosure: Brass (Nickel plated) Resin part: ABS					
Cable		0.08 mm ² 3-core oil, heat and cold resistant cabtyre cable, 3 m 9.843 ft long	0.1 mm ² 3-core flexible, oil and heat resistant cabtyre cable, 3 m 9.843 ft long	0.14 mm ² 3-core oil, heat and cold resistant cabtyre cable, 3 m 9.843 ft long	0.15 mm ² 3-core flexible, oil and heat resistant cabtyre cable, 3 m 9.843 ft long	0.14 mm ² 3-core, oil, heat and cold resistant cabtyre cable, 3 m 9.843 ft long					
Cable extension		Extension up to total 100 m 328.084 ft is possible with 0.3 mm ² , or more, cable.								Extension up to total 100 m 328.084 ft is possible with 0.14 mm ² , or more, cable.	
Weight (Note 3)		30 g approx.				60 g approx.					
Accessories		Nut: 2 pcs. Toothed lock washer: 1 pc.		Nut: 2 pcs. Toothed lock washer: 2 pcs.		Nut: 2 pcs. Toothed lock washer: 1 pc.		Nut: 2 pcs. Toothed lock washer: 2 pcs.		Nut: 2 pcs. Toothed lock washer: 1 pc.	

Notes: 1) The maximum operation distance stands for the maximum distance for which the sensor can detect the standard sensing object. The stable sensing range stands for the sensing range for which the sensor can stably detect the standard sensing object even if there is an ambient temperature drift and/or supply voltage fluctuation.
 2) The maximum sink current varies depending on the ambient temperature. Refer to 'I/O CIRCUIT AND WIRING DIAGRAMS' (p.749) for details.
 3) The given weight of the threaded type includes the weight of two nuts and one toothed lock washer.

I/O CIRCUIT AND WIRING DIAGRAMS

GX-5S □ GX-8M □
GX-8ML □

I/O circuit diagram

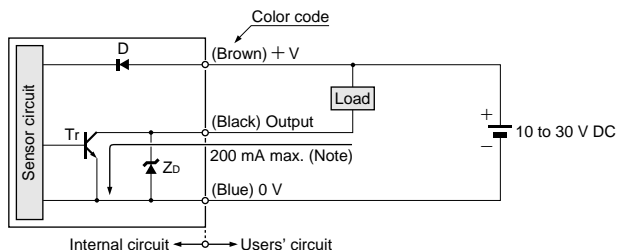

Symbols ... D : Reverse supply polarity protection diode
Zb: Surge absorption zener diode
Tr: NPN output transistor

- If a capacitor of 1 μ F or more is connected between 0 V and output or between + V and output, connect a 100 Ω resistor in series as shown below.

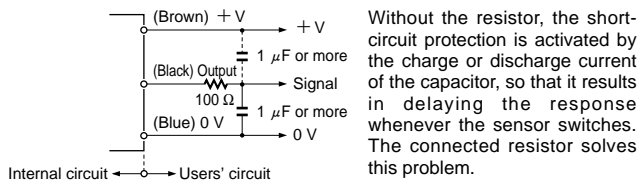

Wiring diagram

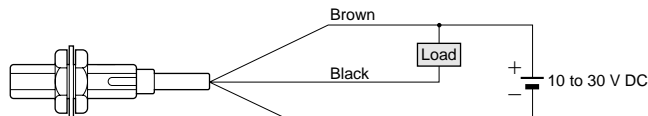

Note: The maximum sink current varies depending on the ambient temperature.

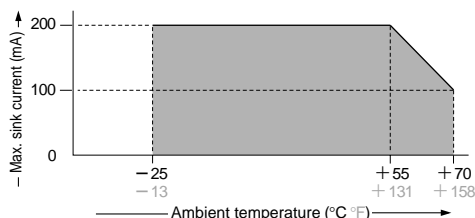

GX-3S □ GX-5M □
GX-4S □

I/O circuit diagram

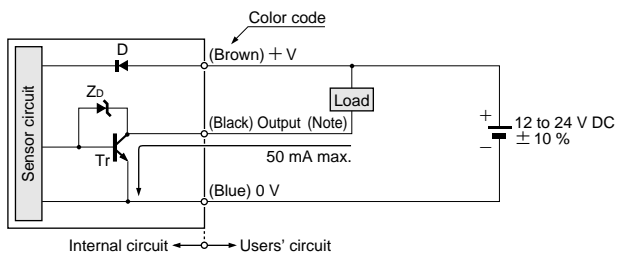

Note: GX-3S □, GX-4S □ and GX-5M □ do not incorporate a short-circuit protection at the output. Do not connect them directly to a power supply or a capacitive load.

Symbols ... D : Reverse supply polarity protection diode
Zb: Surge absorption zener diode
Tr: NPN output transistor

Wiring diagram

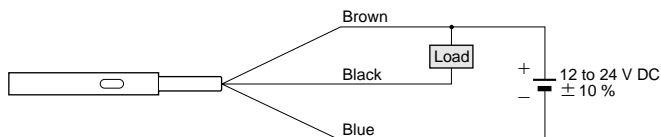

GX

SENSING CHARACTERISTICS (TYPICAL)

GX-3S GX-5M
GX-4S

Sensing field

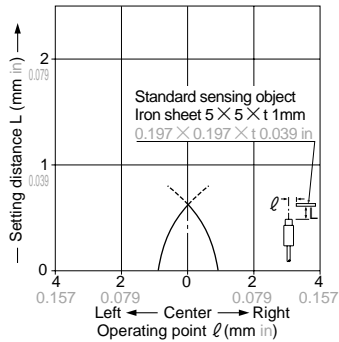

Correlation between sensing object size and sensing range

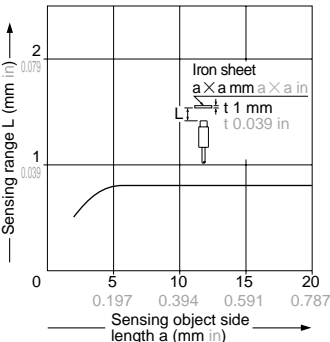

As the sensing object size becomes smaller than the standard size (iron sheet $5 \times 5 \times t$ mm $0.197 \times 0.197 \times t$ in), the sensing range shortens as shown in the left figure.

GX-5S

Sensing field

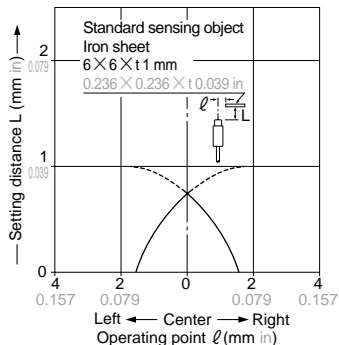

Correlation between sensing object size and sensing range

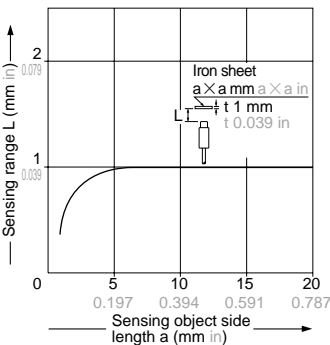

As the sensing object size becomes smaller than the standard size (iron sheet $6 \times 6 \times t$ mm $0.236 \times 0.236 \times t$ in), the sensing range shortens as shown in the left figure.

GX-8M

Sensing field

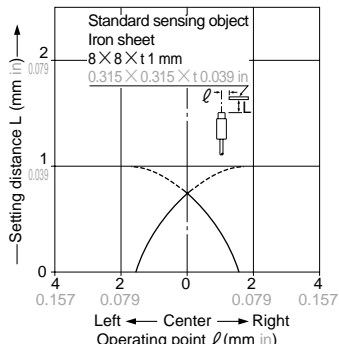

Correlation between sensing object size and sensing range

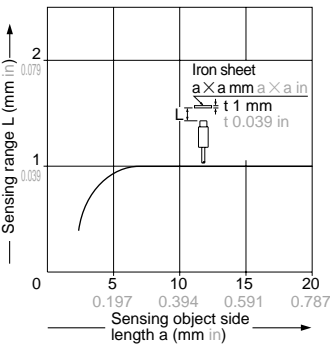

As the sensing object size becomes smaller than the standard size (iron sheet $8 \times 8 \times t$ mm $0.315 \times 0.315 \times t$ in), the sensing range shortens as shown in the left figure.

GX-8ML

Sensing field

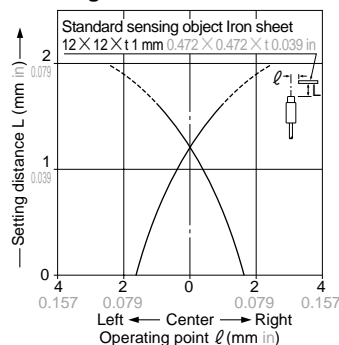

Correlation between sensing object size and sensing range

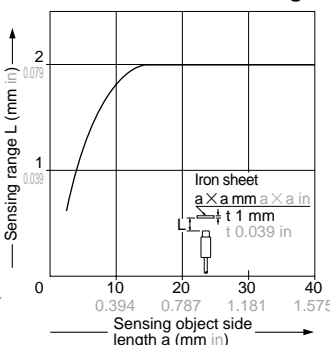

As the sensing object size becomes smaller than the standard size (iron sheet $12 \times 12 \times t$ mm $0.472 \times 0.472 \times t$ in), the sensing range shortens as shown in the left figure.

PRECAUTIONS FOR PROPER USE

Refer to p.1152~ for general precautions.



This product is not a safety sensor. Its use is not intended or designed to protect life and prevent body injury or property damage from dangerous parts of machinery. It is a normal object detection sensor.

Mounting

- The tightening torque should be as given below.

Mounting with set screw

<Shielded threaded type>

- Tighten the set screw on the flat surface of the sensor without applying excessive force. Make sure to use a set screw with a cup-point end.

Set screw
(M4 or less)
(Note)

Note: To fasten **GX-5M**, use a M3 or less set screw.

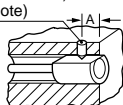

Model No.	Set screw tightening position A (mm in)	Tightening torque
GX-5M	5 to 10 0.197 to 0.394	0.29 N·m
GX-8M	8 to 22 0.315 to 0.866	0.29 N·m

<Non-threaded type and non-shielded threaded type>

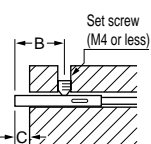

Model No.	B (mm in)	C (mm in)	Tightening torque
GX-3S	5 to 10 0.197 to 0.394	3 0.118	0.29 N·m
			0.58 N·m
GX-4S	5 to 10 0.197 to 0.394	3 0.118	0.58 N·m
GX-5S	8 to 20 0.315 to 0.787	5 0.197	0.29 N·m
GX-8ML	13 to 22 0.517 to 0.866	10 0.394	0.29 N·m

Note: The protrusion should be kept C (mm in) or more to avoid reduction of sensing range.

- To fasten **GX-3S** and **GX-4S**, use a M3 or less set screw and tighten it from a direction perpendicular to the operation indicator.

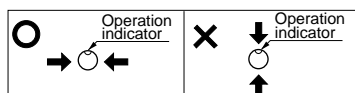
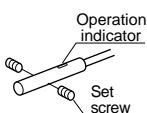

- When using the C bracket, place it on the sensor at a distance of 3 mm 0.118 in or more from the sensor end.

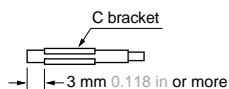

- To fasten the non-shielded threaded type, tighten the set screw on the flat surface of the sensor.

Mounting with nut

- Note that the maximum tightening torque differs according to the location of the nuts.

<Shielded threaded type>

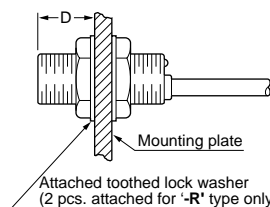

<Non-shielded threaded type>

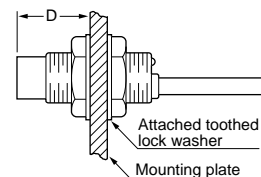

Model No.	D (mm in)	Tightening torque
GX-5M	2 to 3 0.079 to 0.118	0.49 N·m
	3 0.118 or more	1.47 N·m
GX-8M	3 to 11 0.118 to 0.433	1.47 N·m
	11 0.433 or more	3.43 N·m
GX-8ML	9 to 11 0.345 to 0.433	0.98 N·m
	11 0.433 or more	3.43 N·m

Note: Mount such that the nuts do not protrude from the threaded portion.

PRECAUTIONS FOR PROPER USE

Refer to p.1152~ for general precautions.

Distance from surrounding metal

- As metal around the sensor may affect the sensing performance, pay attention to the following points.

Influence of surrounding metal

- The surrounding metal will affect the sensing performance. Keep the minimum distance specified in the table below.

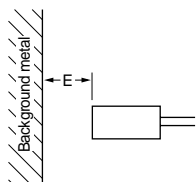

Model No.	E (mm in)
GX-3S □	3 0.118
GX-4S □	3 0.118
GX-5S □	4 0.157
GX-5M □	3 0.118
GX-8M □	4 0.157
GX-8ML □	8 0.315

Embedding of the sensor in metal

- Sensing range may decrease if the sensor is completely embedded in metal. Especially for the non-threaded type and the non-shielded type, keep the minimum distance specified in the table below.

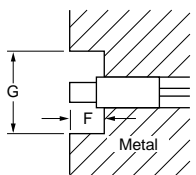

Model No.	F (mm in)	G (mm in)
GX-3S □	3 0.118	φ12 φ0.472
GX-4S □	3 0.118	φ12 φ0.472
GX-5S □	5 0.197	φ15.4 φ0.606
GX-8ML □	10 0.394	φ30 φ1.181

Mutual interference

- When two or more sensors are installed in parallel or face to face, keep the minimum separation distance specified below to avoid mutual interference.

Face to face mounting

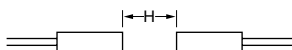

Model No.	H (mm in)	J (mm in)
GX-3S □	16 0.630	16 0.630
GX-4S □	16 0.630	16 0.630
GX-5S □	20 0.787	15 0.591
GX-5M □	10 0.394	10 0.394
GX-8M □	20 0.787	15 0.591
GX-8ML □	50 1.969	30 1.181

Parallel mounting

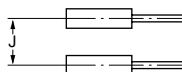

Sensing range

- The sensing range is specified for the standard sensing object. With a non-ferrous metal, the sensing range is obtained by multiplying with the correction coefficient specified below.

Correction coefficient

Model No. Metal	GX-3S □ GX-4S □	GX-5M □	GX-5S □ GX-8M □ GX-8ML □
Iron	1	1	1
Stainless steel (SUS304)	0.65 approx.	0.83 approx.	0.70 approx.
Brass	0.36 approx.	0.61 approx.	0.40 approx.
Aluminum	0.30 approx.	0.58 approx.	0.35 approx.

Note: The sensing range also changes if the sensing object is plated.

Others

- Do not use during the initial transient time (10 ms) after the power supply is switched on.
- When the sensor is mounted on a moving base, stress should not be applied to the sensor cable joint.
 (Sensors attached with flexible cable are also available.)
 They are identified by the suffix '-R' at the end of the model No.

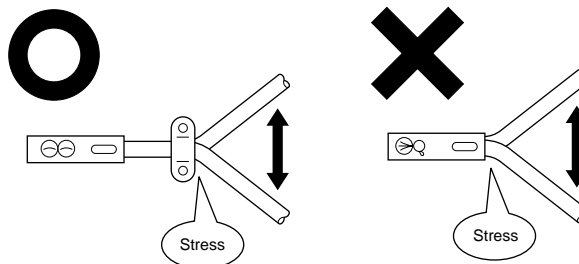

- GX-3S**□, **GX-4S**□ and **GX-5M**□ do not incorporate a short-circuit protection at the output. Do not connect them directly to a power supply or a capacitive load.

DIMENSIONS (Unit: mm in) The CAD data in the dimensions can be downloaded from the SUNX website: <http://www.sunx.co.jp/>

GX-3S Sensor

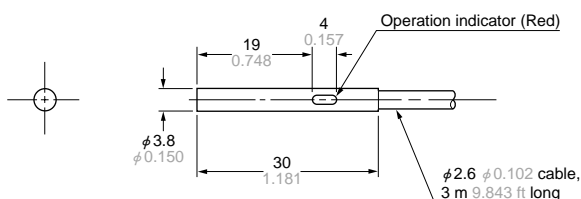

GX-4S Sensor

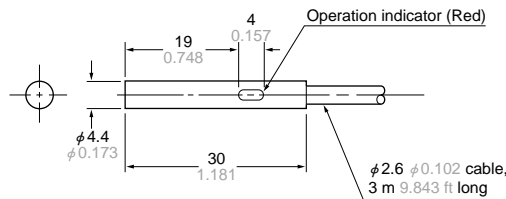

GX-5S Sensor

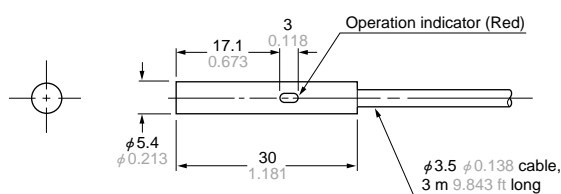

GX-5M Sensor

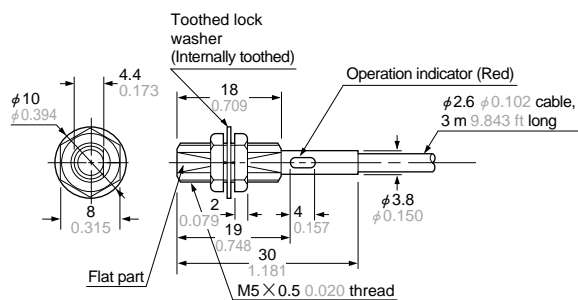

GX-8M Sensor

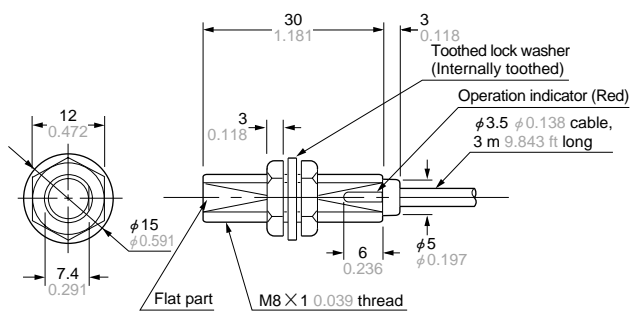

GX-8ML Sensor

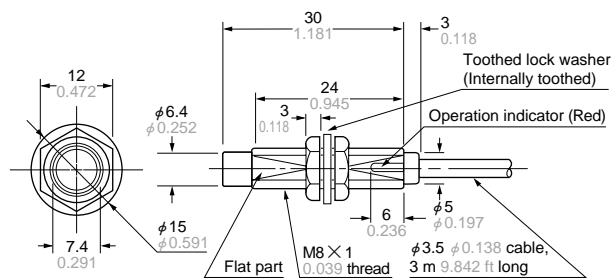

MS-SS3-2 C bracket for GX-3S (Accessory)

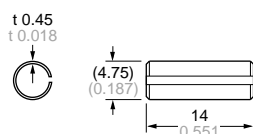

Note: By using the C bracket, the applicable tightening force can be doubled.

MS-SS3 MS-SS5 Sensor mounting bracket for GX-3S (Accessory) Sensor mounting bracket for GX-5S (Accessory)

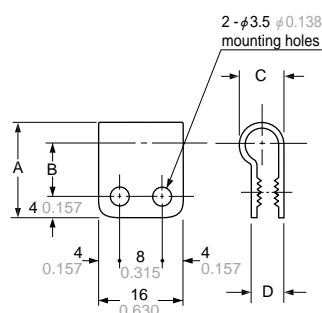

Model No.	MS-SS3	MS-SS5
Symbol		
A	16 0.630	18 0.709
B	9 0.354	10 0.394
C	6.3 0.248	8.3 0.327
D	4.9 0.193	6.1 0.240
Applicable model No.	GX-3S <input type="checkbox"/>	GX-5S <input type="checkbox"/>

Material: Nylon 66