



PRESSURE SENSOR

DIGITAL PRESSURE SENSOR

DP-100 SERIES



A New Global Standard

Dual display for the digital pressure sensors of the future



Dual 3-color display makes operation easier!

The dual display means that the “current value” and the “threshold value” can be displayed at the same time to improve ease of operation and visual checking.
Introducing a new standard in digital pressure sensor technology.

A new global standard “Current value” and “threshold value” can be checked at the same time!

Dual display allows direct setting of threshold value

Equipped with a 30 mm 1.181 in square compact-sized dual display. Because the current value and the threshold value can be checked at the same time, the threshold value can be set and checked smoothly without having to switch screen modes. ON / OFF operations are still carried out while the threshold values are being set, so setting to the same sensitivity as dial control-type sensors is possible. And naturally a key lock function is also equipped.

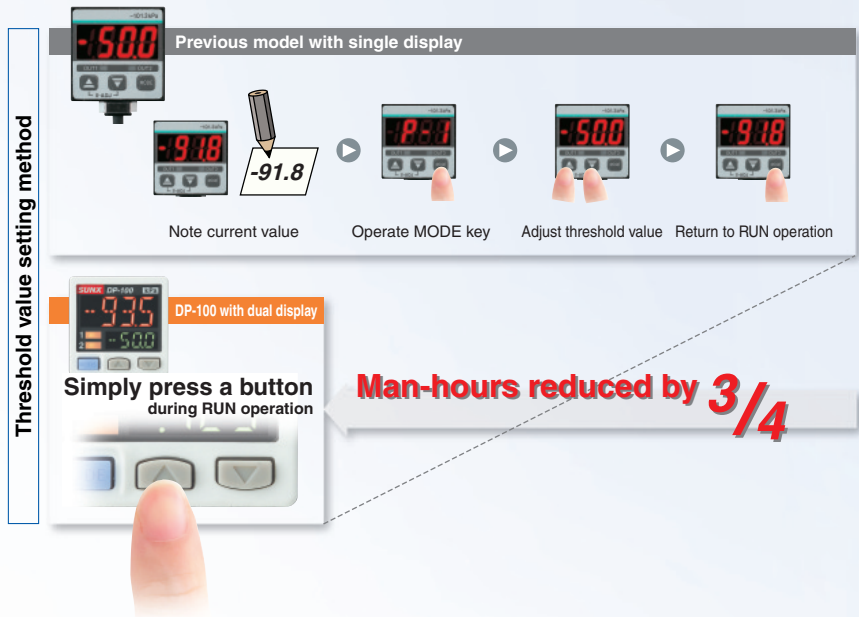

3-color display (Red, Green, Orange)

The main display changes color in line with changes in the status of output ON / OFF operation, and it also changes color while setting is in progress. The sensor status can therefore be understood easily, and operating errors can be reduced.

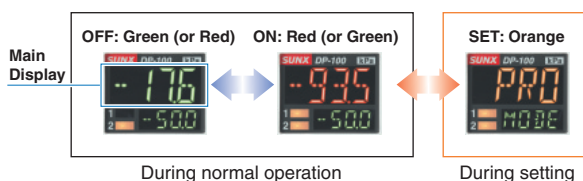

Readable digital display!

12 segments are used and an alphanumeric display has been adopted. This improves visual checking of letters and numbers.

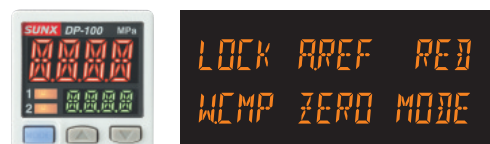

Dual Display + Direct setting



Direct setting means
**Works like a dial
control type sensor**

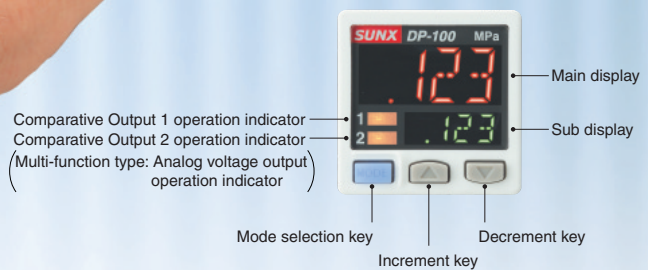

Copy function lets work be carried out accurately and quickly

Copy function reduces man-hours and human error

Sensors can be connected to a master sensor one by one, and a copy of the setting details for the master sensor can be transmitted as data to the other sensors. If making the same settings for multiple sensors, this prevents setting errors from occurring with the other sensors and also reduces the number of changes required to instruction manuals when equipment designs are changed.

Setting details can be copied.

Copying via copy unit



Copying via wiring

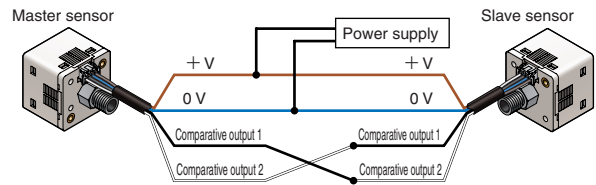

Details transmitted



Details received



Details copied

Advantage 1 Setting man-hours are reduced and sensor setting time is shortened.

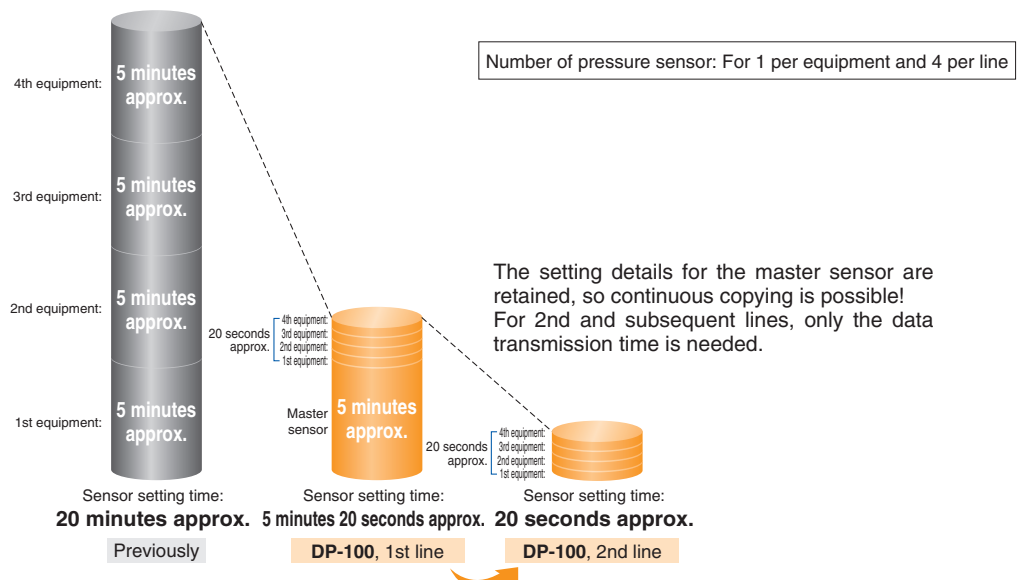

Advantage 2 Human operating error is reduced.

- Because all details are copied automatically, it prevents problems occurring as a result of human error.
- Instruction manuals can be updated easily when changes occur to equipment design!

Setting is smooth and easy

The sensor's setting operation mode has a 3-level configuration to suit the frequency of use.

The setting levels are clearly separated into "RUN mode" for operation settings that are carried out daily, "MENU SETTING mode" for basic settings, and "PRO mode" for special and detailed setting. These make setting operations easy to understand and easy to carry out.

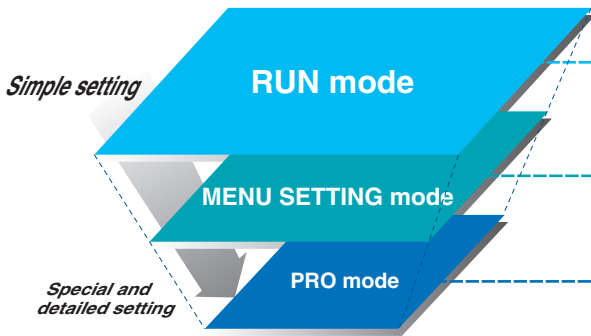

RUN mode



Settings such as threshold value adjustment and key lock operation can be carried out while the sensor is operating.

MENU SETTING mode



Basic settings such as output mode setting and NO / NC switching can be carried out.

PRO mode



High-level function settings such as hysteresis adjustment and the copy function can be carried out.

Display is orange while setting is in progress

The display appears in red and green during RUN operation, but it changes to orange while setting is in progress, so that the sensor status can be viewed at a glance.

RUN operation

RUN mode



Red or green when output is ON / OFF

While setting

MENU SETTING mode

PRO mode



Orange while setting is in progress

Default settings that can be used straight away

Easy-to-use default settings are provided for applications that are used frequently by pressure sensors. The default settings for low pressure types are ideal for suction checking applications, and those for high pressure types are ideal for checking reference pressure.

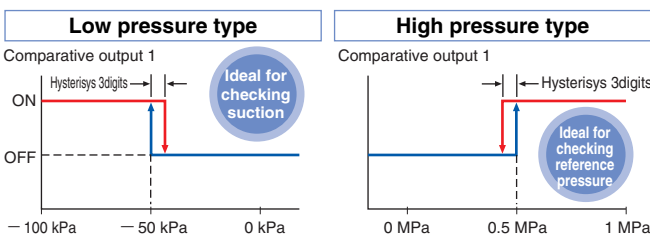

Buttons with good clicking touch

The buttons have a good clicking touch, allowing smooth setting.



The clicking feeling is transmitted even through gloves.

Reset function

If a problem ever occurs with the sensor settings, they can be returned to the default settings.

Full range of performance and functions in a compact body

All models in the line-up are compound pressure types

No sensor settings are required to switch between positive pressure and negative pressure, so that the number of registered part numbers can be decreased.

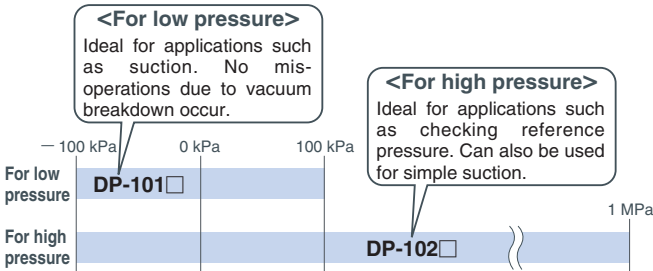

High performance accomplished **Low pressure type**

The low pressure type displays measurements in 0.1 kPa at a resolution of 1/2,000 and has a response time of 2.5 ms (variable up to 5,000 ms), $\pm 0.5\%$ F.S. temperature characteristics and $\pm 0.1\%$ F.S. repeatability, giving it high performance.

- Resolution: 1/2,000
- Response time: 2.5 ms
- Temperature characteristics: $\pm 0.5\%$ F.S.
- Repeatability: $\pm 0.1\%$ F.S.



Displays measurements in 0.1 kPa

Equipped with independent dual output **Standard type**

Equipped with two independent comparative outputs, and separate sensing modes can be selected for each of them. Since there are two comparative outputs, one of the comparative outputs can even be used for alarm output. In addition, if an output is not being used, it can be disabled.

- Vacuum breakdown can also be checked during suction applications!

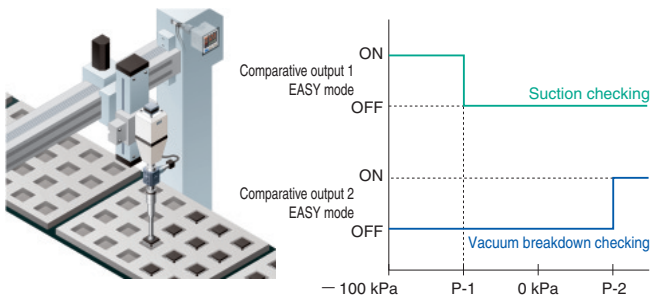

- Reference pressure alarm output is possible during reference pressure checking!

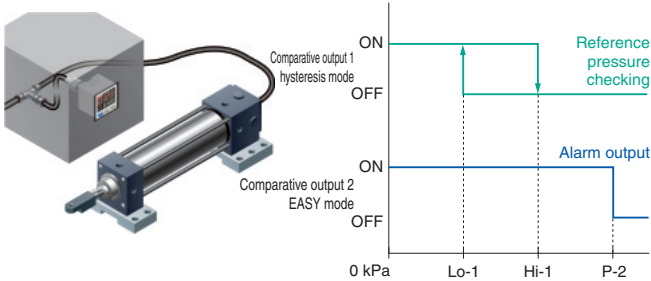

Three output modes are suitable for a wide range of applications

1 EASY mode

This mode is used for comparative output ON / OFF control.

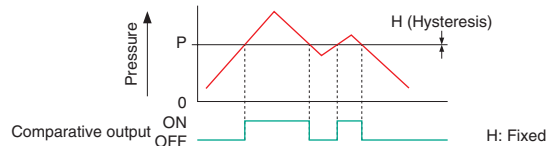

- Notes: 1) Hysteresis can be fixed to one of eight different levels.
- 2) "P-1" appears in the sub display for comparative output 1, and "P-2" appears for comparative output 2.

2 Hysteresis mode

This mode is used for setting comparative output hysteresis to the desired level and for carrying out ON / OFF control.

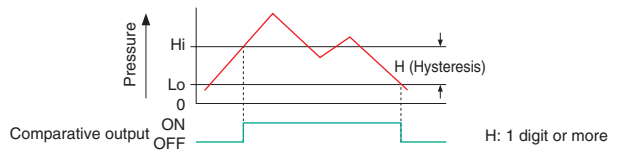

- Note: "Hi-1" or "Lo-1" appears in the sub display for comparative output 1, and "Hi-2" or "Lo-2" appears for comparative output 2.

3 Window comparator mode

This mode is used for setting comparative output ON and OFF at pressures within the setting range.

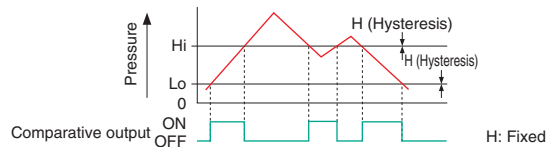

- Notes: 1) Hysteresis can be fixed to one of eight different levels.
- 2) "Hi-1" or "Lo-1" appears in the sub display for comparative output 1, and "Hi-2" or "Lo-2" appears for comparative output 2.

Equipped with auto-reference / remote zero-adjustment functions, Multi-function type
More precise pressure management is possible with a minimum of effort

If the reference pressure of the device changes, the auto-reference function partially shift the comparative output judgment level by the amount that the reference pressure shifts, and the remote zero-adjustment function can reset the display value to zero via external input. These functions are ideal for places where the reference pressure fluctuates wildly, or where fine settings are desired.

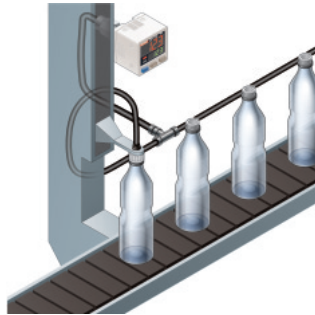

Without auto-reference and remote zero-adjustment functions

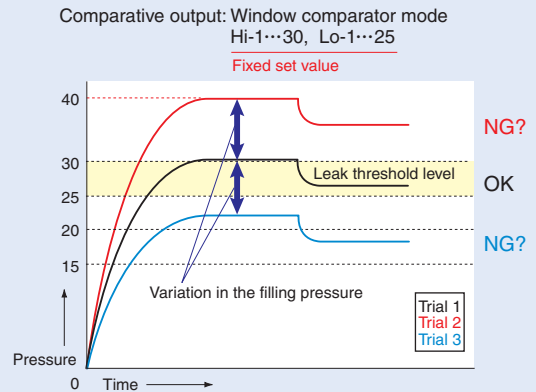

Because the threshold level is fixed for conventional pressure sensors, changes in the reference pressure result in wrong decisions.

With auto-reference function applied

Comparative output: Window comparator mode
 Hi-1...0, Lo-1... -5
 Sets the absolute threshold level

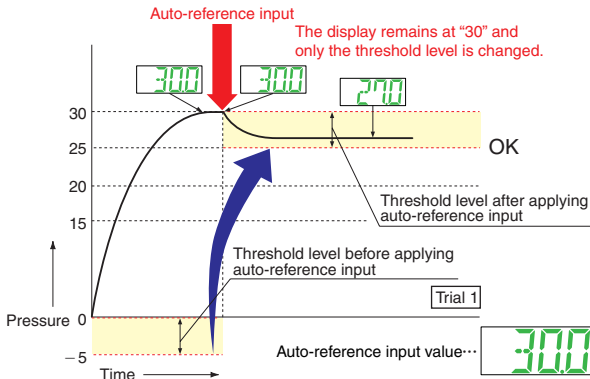

When auto-reference input is applied, the reference pressure "30" is added to the threshold level. If the reference pressure changes to "20" or "40", the auto-reference input compensates for this every time by changing the threshold level, so any variation in the filling pressure can be ignored.

With remote zero-adjustment function applied

Comparative output: Window comparator mode
 Hi-1...0, Lo-1... -5
 Sets the absolute threshold level

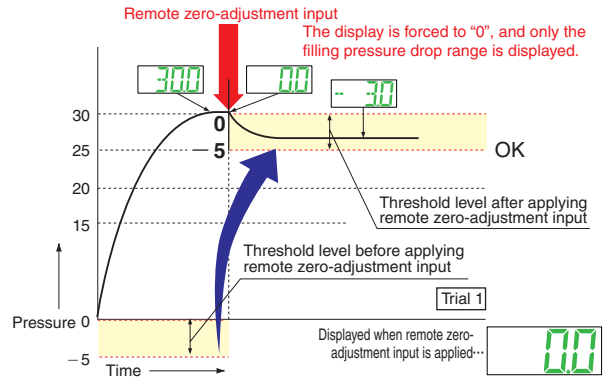

When remote zero-adjustment input is applied, the reference pressure is forced to "0". If the reference pressure changes to "20" or "40", the remote zero-adjustment input adjusts the reference pressure to "0" every time the reference pressure changes, so any variation in the filling pressure can be ignored.

Peak hold and Bottom hold functions

The peak values and bottom values for fluctuating pressures can be displayed using the dual display.



Energy-saving design! Equipped with an ECO mode

This mode lowers the display luminance to cut power consumption by approximately 30%. The displays can also be turned off completely to achieve a power saving of approximately 40%.

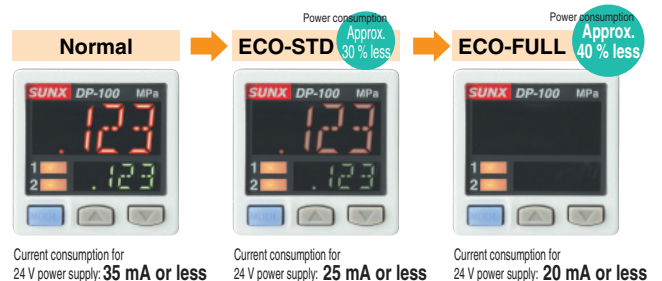

Other useful functions

Sub display can be customized

The sub display can be set to indicate any other desired values or letters apart from the threshold value. This eliminates the need for tasks such as affixing a label to the device to indicate the normal pressure value.



Indicates desired values and letters



Setting details can be understood at a glance

The DP-100 setting details appear in the digital display. Because the settings are in numeric form that can be easily understood, it is useful for times such as when receiving technical support by telephone.

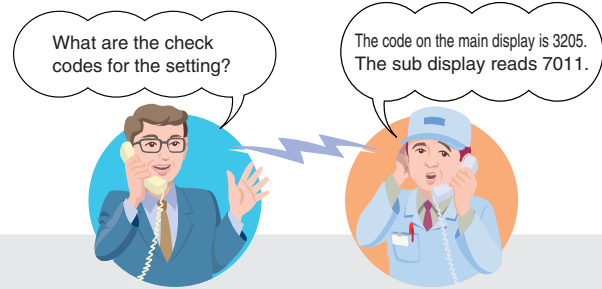

Cable can be connected with one-touch connection

The accessory connector attached cable (2 m 6.562 ft) can be connected easily with one-touch connection.

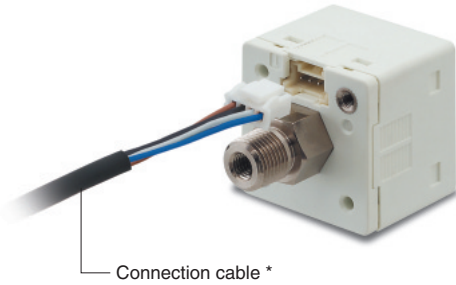

Connection cable *

* Options: 1 m 3.281 ft / 3 m 9.843 ft / 5 m 16.404 ft types are also available.

Types without connector attached cable are also available DP-10□-J

Commercially-available connectors can be used for cable connections. Only the required length of cable needs to be used, which contributes to a reduced amount of wastage for unneeded cable.



M8 plug-in connector types are also available. (Only for Europe) DP-11□-E-P-J



Installation is also easy!

Tight installation to panels is possible

An exclusive mounting bracket that is suitable for 1 to 6 mm 0.039 to 0.236 in panel thickness is available.

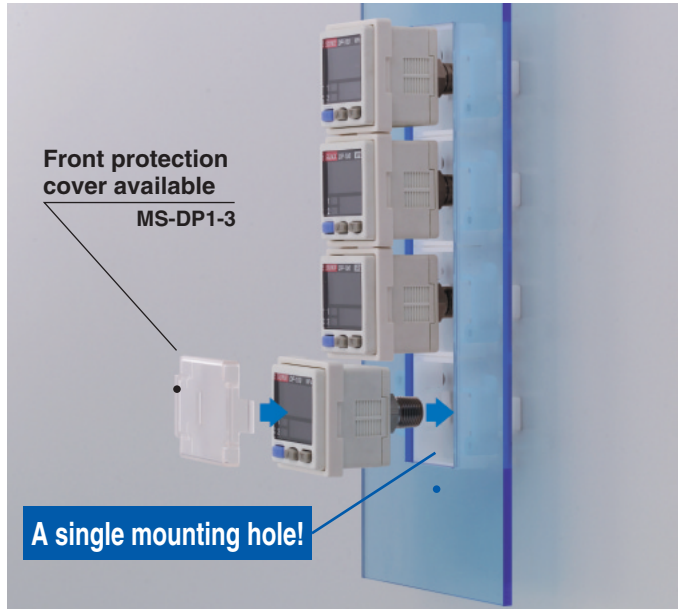
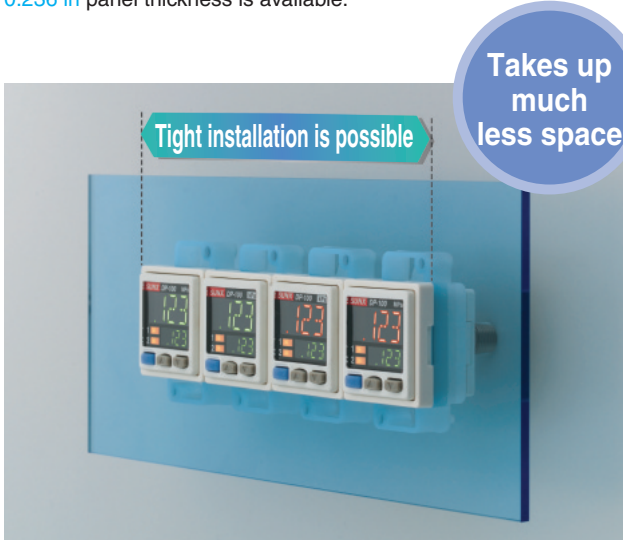

- An exclusive mounting bracket (MS-DP1-1) that supports tight installation is available

Space savings can also be obtained if an L-shaped mounting bracket is used.

- MS-DP1-1



- MS-DP1-5

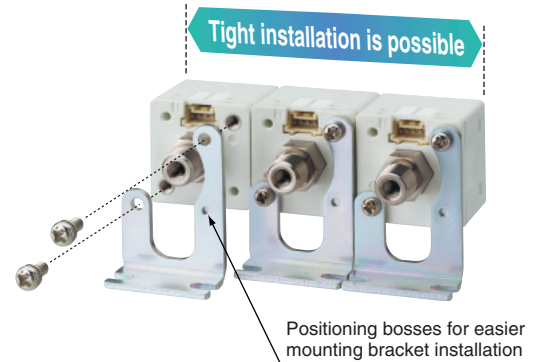

Short pressure port type is lightweight and takes up little space

Space saving!

Compact size with a depth of only 30 mm 1.181 in, so that it can easily fit into narrow spaces.

Light weight of 30 g! *

10 g lighter than standard types. This reduces the loads on movable parts such as robot arms.

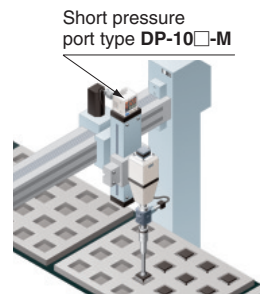
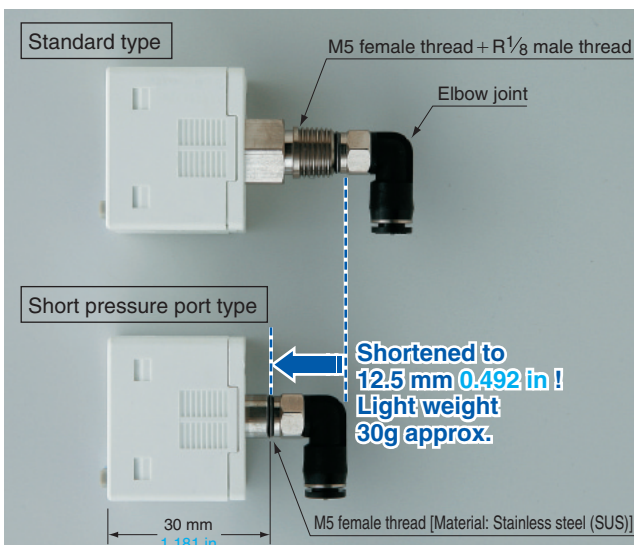

* Excluding cables with connector attached

Ideal for clean environments!

Stainless steel (SUS303) which does not rust or generate gas is used as the port material.

* The illustration shows connection using an elbow joint. The elbow joint is sold separately.

Switch-over of the pressure port or flat mounting on the wall is possible

By mounting the flat attachment to **DP-10□-M(-P)**, pressure port and cable can now be pulled out in downward, left or right directions. Flat mounting on surfaces such as the wall is made possible.

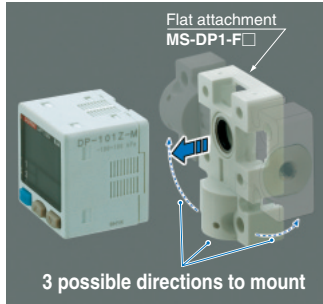

For short pressure port type

Previous model **DP2 / DP3** series can be switched over to **DP-100** series.

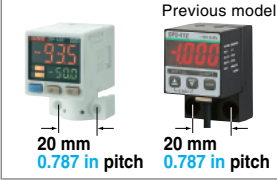

Model No.	Pressure port
MS-DP1-FM	M5 female thread
MS-DP1-FR	Rc ¹ / ₈ female thread
MS-DP1-FN	NPT ¹ / ₈ female thread
MS-DP1-FE	G ¹ / ₈ female thread

Rc¹/₈ conversion bushing improves compatibility with the previous model

For short pressure port type

By equipping the push-in converter with **DP-10□-M(-P)**, pressure port can be converted from M5 female thread to Rc¹/₈ female thread. Bore diameter conversion to the **DP2 / DP3** series is possible.

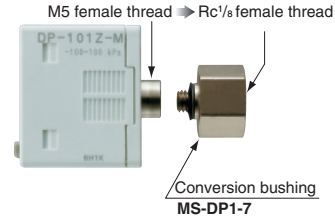

ORDER GUIDE

Type			Appearance	Rated pressure range	Model No.	Pressure port	Comparative output	
Standard pressure port type	Asia	Standard	For low pressure	- 100.0 to + 100.0 kPa	DP-101	M5 female thread + R 1/8 male thread	NPN open-collector transistor	
			For high pressure	- 0.100 to + 1.000 MPa	DP-102			
		Multi-function	For low pressure	- 100.0 to + 100.0 kPa	DP-101A			
			For high pressure	- 0.100 to + 1.000 MPa	DP-102A			
	Europe	Standard	For low pressure	- 100.0 to + 100.0 kPa	DP-101-E-P	M5 female thread + G 1/8 male thread	PNP open-collector transistor	
			For high pressure	- 0.100 to + 1.000 MPa	DP-102-E-P			
		Multi-function	For low pressure	- 100.0 to + 100.0 kPa	DP-101A-E-P			
			For high pressure	- 0.100 to + 1.000 MPa	DP-102A-E-P			
	M8 plug-in connector type	Standard	For low pressure	- 100.0 to + 100.0 kPa	DP-111-E-P-J	M5 female thread + G 1/8 male thread	PNP open-collector transistor	
			For high pressure	- 0.100 to + 1.000 MPa	DP-112-E-P-J			
		Multi-function	For low pressure	- 100.0 to + 100.0 kPa	DP-111A-E-P-J			
			For high pressure	- 0.100 to + 1.000 MPa	DP-112A-E-P-J			
North America	Standard	For low pressure	- 100.0 to + 100.0 kPa	DP-101-N	M5 female thread + NPT 1/8 male thread	NPN open-collector transistor		
		For high pressure	- 0.100 to + 1.000 MPa	DP-101-N-P		PNP open-collector transistor		
		Multi-function	For low pressure	- 100.0 to + 100.0 kPa		DP-102-N	NPN open-collector transistor	
			For high pressure	- 0.100 to + 1.000 MPa		DP-102-N-P	PNP open-collector transistor	
	For low pressure		- 100.0 to + 100.0 kPa	DP-101A-N		NPN open-collector transistor		
	For high pressure		- 0.100 to + 1.000 MPa	DP-101A-N-P		PNP open-collector transistor		
	Multi-function	For low pressure	- 100.0 to + 100.0 kPa	DP-102A-N		NPN open-collector transistor		
		For high pressure	- 0.100 to + 1.000 MPa	DP-102A-N-P		PNP open-collector transistor		
Short pressure port type		Asia	Standard	For low pressure	- 100.0 to + 100.0 kPa	DP-101-M	M5 female thread	NPN open-collector transistor
				For high pressure	- 0.100 to + 1.000 MPa	DP-101-M-P		PNP open-collector transistor
	Multi-function		For low pressure	- 100.0 to + 100.0 kPa	DP-102-M	NPN open-collector transistor		
			For high pressure	- 0.100 to + 1.000 MPa	DP-102-M-P	PNP open-collector transistor		
	Multi-function	For low pressure	- 100.0 to + 100.0 kPa	DP-101A-M	NPN open-collector transistor			
		For high pressure	- 0.100 to + 1.000 MPa	DP-101A-M-P	PNP open-collector transistor			
		For low pressure	- 100.0 to + 100.0 kPa	DP-102A-M	NPN open-collector transistor			
		For high pressure	- 0.100 to + 1.000 MPa	DP-102A-M-P	PNP open-collector transistor			



* **CN-14A-C2**
(Connector attached cable 2 m 6.562 ft) is attached.
(Excluding M8 plug-in) connector type

Type without connector attached cable

Type without connector attached cable **CN-14A-C2** is available. When ordering this type, suffix “-J” to the Model No. (e.g.) Type without connector attached cable of **DP-101-N** is “**DP-101-N-J**”

Accessory

• CN-14A-C2

(Connector attached cable 2 m 6.562 ft)



OPTIONS

Designation	Model No.	Description	
Connector attached cable	CN-14A-C1	Length: 1m 3.281 ft	0.2 mm ² 4-core cabtyre cable with connector on one end Cable outer diameter: ϕ 3.7 mm ϕ 0.146 in
	CN-14A-C2 (Note)	Length: 2m 6.562 ft	
	CN-14A-C3	Length: 3m 9.843 ft	
	CN-14A-C5	Length: 5m 16.404 ft	
Connector attached cable (Flexible cable)	CN-14A-R-C1	Length: 1m 3.281 ft	0.2 mm ² 4-core flexible cabtyre cable with connector on one end Cable outer diameter: ϕ 3.7 mm ϕ 0.146 in
	CN-14A-R-C2	Length: 2m 6.562 ft	
	CN-14A-R-C3	Length: 3m 9.843 ft	
	CN-14A-R-C5	Length: 5m 16.404 ft	
M8 connector attached cable	CN-24A-C2	Length: 2m 6.562 ft	For M8 plug-in connector type The connector on one end Cable outer diameter: ϕ 4 mm ϕ 0.157 in
	CN-24A-C5	Length: 5m 16.404 ft	
Connector	CN-14A	Set of 10 housings and 40 contacts	
Sensor mounting bracket	MS-DP1-1	Allows sensors to be installed on the flooring or ceiling. Multiple sensors can also be mounted closely.	
	MS-DP1-5	Allows sensors to be installed on the wall. Multiple sensors can also be mounted closely.	
Panel mounting bracket	MS-DP1-2	Allows installation to panels with thickness of 1 to 6 mm 0.039 to 0.236 in . Multiple sensors can also be mounted closely.	
	MS-DP1-4	Allows replacement from DP2 / DP3 series to DP-100 series. For newly designed set-up, please use panel mounting bracket MS-DP1-2 for panel mounting.	
Front protection cover	MS-DP1-3	Protects the adjustment surfaces of sensors. (Can be attached when using the panel mounting bracket)	
Conversion bushing	MS-DP1-7	By equipping with DP-100-M(-P) , pressure port can be converted to Rc ¹ / ₈ female thread. Replacement from DP2 / DP3 series is possible.	
Flat attachment	MS-DP1-FM	M5 female thread	Pressure port and cable can now be pulled out in downward, left or right directions. Flat mounting on surfaces such as the wall is made possible.
	MS-DP1-FR	Rc ¹ / ₈ female thread	
	MS-DP1-FN	NPT ¹ / ₈ female thread	
	MS-DP1-FE	G ¹ / ₈ female thread	
Copy unit	SC-SU1	Copy the controller settings to other controllers.	

Note: The connector attached cable **CN-14A-C2** is supplied with the **DP-100** series. (Excluding M8 plug-in connector type).

Panel mounting bracket, Front protection cover

- MS-DP1-2
- MS-DP1-3

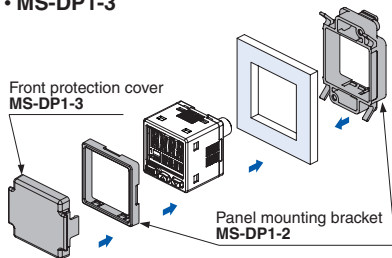

- MS-DP1-4

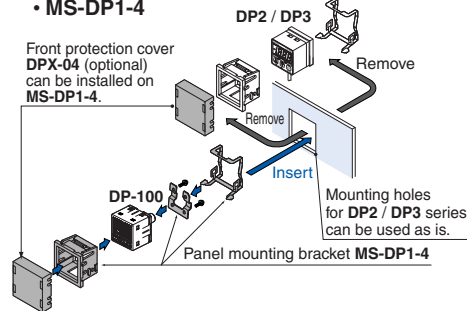

Flat attachment

- MS-DP1-FM
- MS-DP1-FR
- MS-DP1-FN
- MS-DP1-FE

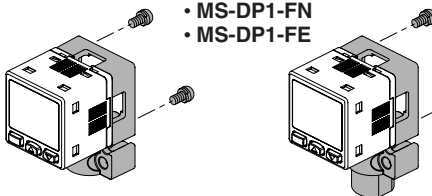

Net weight: **MS-DP1-FM** 15g approx.
MS-DP1-FR/FN/FE 25g approx.
Two M3 (length 8 mm **0.315 in**) screws,
two M4 (length 20 mm **0.787 in**) screws are attached.

Recommended connector

Contact: SPHD-001T-P0.5, Housing: PAP-04V-S
(Manufactured by J.S.T. Mfg.Co., Ltd.)

Note: Contact the manufacturer for details of the recommended products.

Recommended crimping tool

Model No.: YC-610R

(Manufactured by J.S.T. Mfg. Co., Ltd.)

Note: Contact the manufacturer for details of the recommended products.

Connector attached cable

- CN-14A-C□
- CN-14A-R-C□

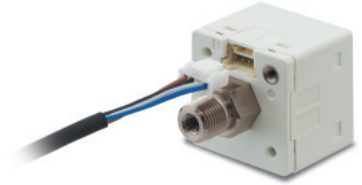

M8 connector attached cable

- CN-24A-C□

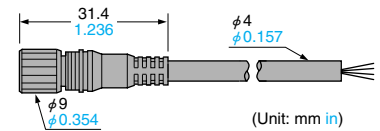

Sensor mounting bracket

- MS-DP1-1

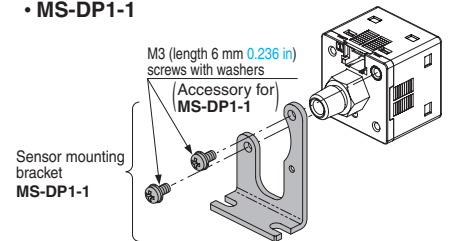

- MS-DP1-5

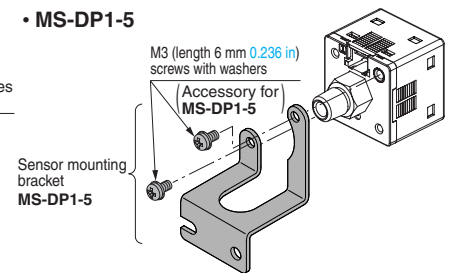

Conversion bushing

- MS-DP1-7

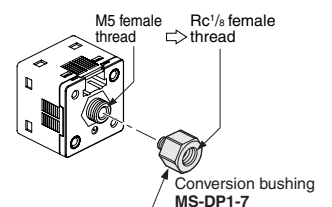

Copy unit

- SC-SU1

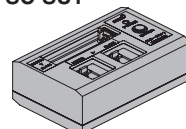

SPECIFICATIONS

Item	Model No.	Type	Standard		Multi-function	
			For low pressure	For high pressure	For low pressure	For high pressure
			Asia (Note 2)	DP-101(-M)(-P)	DP-102(-M)(-P)	DP-101A(-M)(-P)
		Europe	DP-101-E-P	DP-102-E-P	DP-101A-E-P	DP-102A-E-P
		M8 plug-in connector type	DP-111-E-P-J	DP-112-E-P-J	DP-111A-E-P-J	DP-112A-E-P-J
		North America (Note 2)	DP-101-N(-P)	DP-102-N(-P)	DP-101A-N(-P)	DP-102A-N(-P)
Type of pressure			Gauge pressure			
Rated pressure range			- 100.0 to + 100.0 kPa	- 0.100 to + 1.000 MPa	- 100.0 to + 100.0 kPa	- 0.100 to + 1.000 MPa
Set pressure range			$\left. \begin{array}{l} -100.0 \text{ to } +100.0 \text{ kPa} \\ -1.020 \text{ to } +1.020 \text{ kgf/cm}^2 \\ -1.000 \text{ to } +1.000 \text{ bar} \\ -14.50 \text{ to } +14.50 \text{ psi} \\ -750 \text{ to } +750 \text{ mmHg} \\ -29.5 \text{ to } 29.5 \text{ inHg} \end{array} \right\}$	$\left. \begin{array}{l} -0.100 \text{ to } +1.000 \text{ MPa} \\ -100 \text{ to } +1,000 \text{ kPa} \\ -1.02 \text{ to } +10.20 \text{ kgf/cm}^2 \\ -1.00 \text{ to } +10.00 \text{ bar} \\ -14.6 \text{ to } +145.0 \text{ psi} \end{array} \right\}$	$\left. \begin{array}{l} -100.0 \text{ to } +100.0 \text{ kPa} \\ -1.020 \text{ to } +1.020 \text{ kgf/cm}^2 \\ -1.000 \text{ to } +1.000 \text{ bar} \\ -14.50 \text{ to } +14.50 \text{ psi} \\ -750 \text{ to } +750 \text{ mmHg} \\ -29.5 \text{ to } 29.5 \text{ inHg} \end{array} \right\}$	$\left. \begin{array}{l} -0.100 \text{ to } +1.000 \text{ MPa} \\ -100 \text{ to } +1,000 \text{ kPa} \\ -1.02 \text{ to } +10.20 \text{ kgf/cm}^2 \\ -1.00 \text{ to } +10.00 \text{ bar} \\ -14.6 \text{ to } +145.0 \text{ psi} \end{array} \right\}$
Pressure withstandability			500 kPa	1.5 MPa	500 kPa	1.5 MPa
Applicable fluid			Non-corrosive gas			
Selectable unit			For low pressure: kPa, kgf/cm ² , bar, psi, mmHg, inHg, For high pressure: MPa, kPa, kgf/cm ² , bar, psi			
Supply voltage			12 to 24 V DC $\pm 10\%$ Ripple P-P 10% or less			
Power consumption			Normal operation: 840 mW or less (Current consumption 35 mA or less at 24 V supply voltage) ECO mode: 600 mW or less at STD (Current consumption 25 mA or less at 24 V supply voltage) 480 mW or less at FULL (Current consumption 20 mA or less at 24 V supply voltage)			
Comparative output			<Asia (NPN output), North America (NPN output)> NPN open-collector transistor • Maximum sink current: 100 mA • Applied voltage: 30 V DC or less (between comparative output and 0 V) • Residual voltage: 2 V or less (at 100 mA sink current)		<Asia (PNP output), Europe, North America (PNP output)> PNP open-collector transistor • Maximum source current: 100 mA • Applied voltage: 30 V DC or less (between comparative output and +V) • Residual voltage: 2 V or less (at 100 mA source current)	
Output operation / Output modes			NO / NC (selectable by key operation) / EASY mode / Hysteresis mode / Window comparator mode			
Hysteresis			Minimum 1 digit (variable) (however, 2 digits when using psi unit)			
Repeatability			$\pm 0.1\%$ F.S. (within ± 2 digits)	$\pm 0.2\%$ F.S. (within ± 2 digits)	$\pm 0.1\%$ F.S. (within ± 2 digits)	$\pm 0.2\%$ F.S. (within ± 2 digits)
Response time			2.5 ms, 5 ms, 10 ms, 25 ms, 50 ms, 100 ms, 250 ms, 500 ms, 1,000 ms, 5,000 ms, selectable by key operation			
Short-circuit protection			Incorporated			
External input (Note 3) Auto-reference function / Remote zero-adjustment function			_____		<Asia (NPN output), North America (NPN output)> ON voltage: 0.4 V DC or less OFF voltage: 5 to 30 V DC, or open Input impedance: 10 k Ω approx. Input time: 1 ms or more	
Analog voltage output (Note 3)			_____		<Asia (PNP output), Europe, North America (PNP output)> ON voltage: 5 V to +V DC OFF voltage: 0.6 V DC or less, or open Input impedance: 10 k Ω approx. Input time: 1 ms or more	
Display			4 digits + 4 digits 3-color LCD display (Display refresh rate: 250 ms, 500 ms, 1,000 ms, selectable by key operation)			
Displayable pressure range			$\left. \begin{array}{l} -100.0 \text{ to } +100.0 \text{ kPa} \\ -1.020 \text{ to } +1.020 \text{ kgf/cm}^2 \\ -1.000 \text{ to } +1.000 \text{ bar} \\ -14.50 \text{ to } +14.50 \text{ psi} \\ -750 \text{ to } +750 \text{ mmHg} \\ -29.5 \text{ to } 29.5 \text{ inHg} \end{array} \right\}$	$\left. \begin{array}{l} -0.100 \text{ to } +1.000 \text{ MPa} \\ -100 \text{ to } +1,000 \text{ kPa} \\ -1.02 \text{ to } +10.20 \text{ kgf/cm}^2 \\ -1.00 \text{ to } +10.00 \text{ bar} \\ -14.6 \text{ to } +145.0 \text{ psi} \end{array} \right\}$	$\left. \begin{array}{l} -100.0 \text{ to } +100.0 \text{ kPa} \\ -1.020 \text{ to } +1.020 \text{ kgf/cm}^2 \\ -1.000 \text{ to } +1.000 \text{ bar} \\ -14.50 \text{ to } +14.50 \text{ psi} \\ -750 \text{ to } +750 \text{ mmHg} \\ -29.5 \text{ to } 29.5 \text{ inHg} \end{array} \right\}$	$\left. \begin{array}{l} -0.100 \text{ to } +1.000 \text{ MPa} \\ -100 \text{ to } +1,000 \text{ kPa} \\ -1.02 \text{ to } +10.20 \text{ kgf/cm}^2 \\ -1.00 \text{ to } +10.00 \text{ bar} \\ -14.6 \text{ to } +145.0 \text{ psi} \end{array} \right\}$
Indicator			Orange LED (Comparative output 1 operation indicator, comparative output 2 operation indicator: Lights up when each comparative output is ON)		Orange LED (Comparative output 1 operation indicator: Lights up when comparative output is ON, Analog voltage output operation indicator: Lights up when setting)	
Protection			IP40 (IEC)			
Ambient temperature			- 10 to + 50 °C + 14 to + 122 °F, Storage: - 10 to + 60 °C + 14 to + 140 °F			
Ambient humidity			35 to 85 % RH (No dew condensation or icing allowed), Storage: 35 to 85 % RH			
Voltage withstandability			1,000 V AC for one min. between all supply terminals connected together and enclosure			
Insulation resistance			50 M Ω , or more, with 500 V DC megger between all supply terminals connected together and enclosure			
Vibration resistance			10 to 500 Hz frequency, 3 mm 0.118 in amplitude, in X, Y and Z directions for two hours each (when panel is mounted: 10 to 150 Hz frequency, 0.75 mm 0.030 in amplitude, in X, Y and Z directions for two hours each)			
Shock resistance			100 m/s ² acceleration (10 G approx.) in X, Y and Z directions for three times each			
Temperature characteristics			Within $\pm 0.5\%$ F.S. (at +20 °C +68 °F)	Within $\pm 1\%$ F.S. (at +20 °C +68 °F)	Within $\pm 0.5\%$ F.S. (at +20 °C +68 °F)	Within $\pm 1\%$ F.S. (at +20 °C +68 °F)
Pressure port			Asia: M5 female thread + R (PT) 1/8 male thread [excluding DP-□-M(-P)], Europe: M5 female thread + G 1/8 male thread, North America: M5 female thread + NPT 1/8 male thread			
Material			Enclosure: PBT (glass fiber reinforced), LCD display: Acrylic, Pressure port: Brass (nickel plated)(DP-□-M(-P), DP-□-J), Stainless steel (SUS303), Mounting threaded part: Brass (nickel plated), Switch part: Silicone rubber			
Connecting method / Cable length			Connector / Total length up to 100 m 328.084 ft (less than 10 m 32.808 ft when conforming to CE marking) is possible with 0.3 mm ² , or more, cable			
Weight			Net weight: 40 g approx., Gross weight: 135 g approx. (DP-10□-M(-P):125 g approx.)			
Accessories			CN-14A-C2 (Connector attached cable 2 m 6.562 ft): 1pc. (excluding M8 plug-in connector type)			

Notes: 1) Where measurement conditions have not been specified precisely, the conditions used were an ambient temperature of +20 °C +68 °F.
2) Model Nos. of Asia type having "M" are short pressure port type. Model Nos. of Asia and North America types having the suffix "P" are PNP output type.
3) Cannot be used at the same time.

SPECIFICATIONS

Designation	Copy unit
Item	SC-SU1
Applicable sensor	Digital pressure sensor DP-100 series, DPC-100 series, Digital fiber sensor FX-100 series
Supply voltage (Note 1)	12 V DC [AC adapter (accessory): Input 100 to 240 V AC 50 / 60 Hz]
Repeatability of connecting and disconnecting (Note 2)	5,000 times approx.
Ambient temperature	0 to +40 °C 32 to 104 °F (No dew condensation allowed), Storage: -10 to +60 °C +14 to +140 °F
Ambient humidity	35 to 85 % RH, Storage: 35 to 85 % RH
Material	Enclosure base: ABS, Top cover: ABS, Rubber foot: Natural rubber
Weight	Net weight: 190 g approx., Gross weight: 350 g approx.

Notes: 1) For destinations where the shape of the AC adapter plug differs from the shape for Japan, please prepare a separate conversion adapter.
 2) Number of repeatability may vary depending on the usage conditions.

I/O CIRCUIT AND WIRING DIAGRAMS

DP-10□ NPN output type

I/O circuit diagram

Standard type

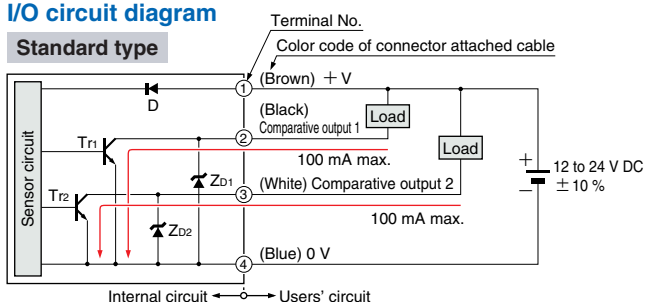

Symbols ... D : Reverse supply polarity protection diode
 Z_{D1}, Z_{D2} : Surge absorption zener diode
 T_{r1}, T_{r2} : NPN output transistor

Multi-function type

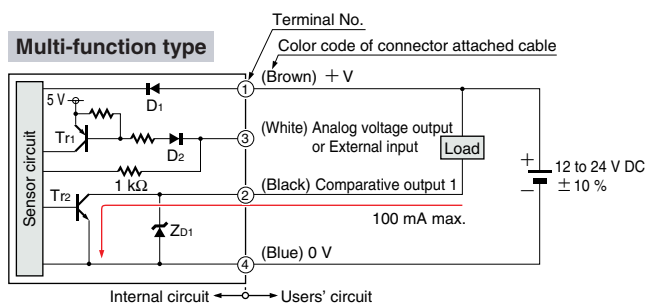

Symbols ... D₁, D₂ : Reverse supply polarity protection diode
 Z_{D1} : Surge absorption zener diode
 T_{r1} : PNP input transistor
 T_{r2} : NPN output transistor

Terminal arrangement diagram

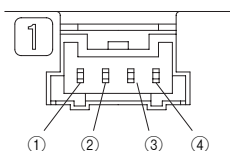

Terminal	Designation
①	+ V
②	Comparative output 1
③	Standard type: Comparative output 2 Multi-function type: Analog voltage output or External input
④	0 V

DP-10□-P PNP output type

I/O circuit diagram

Standard type

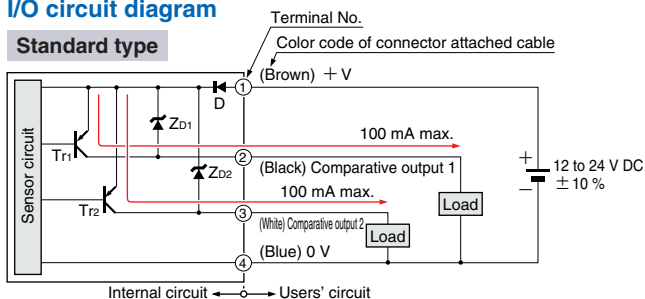

Symbols ... D : Reverse supply polarity protection diode
 Z_{D1}, Z_{D2} : Surge absorption zener diode
 T_{r1}, T_{r2} : PNP output transistor

Multi-function type

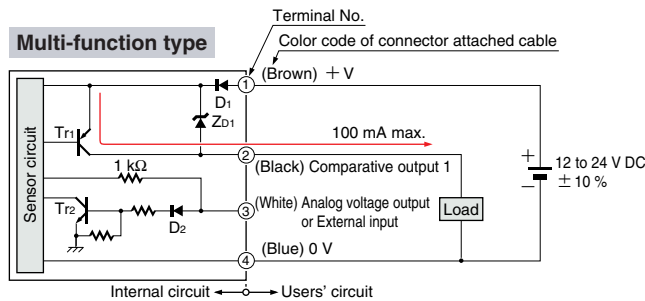

Symbols ... D₁, D₂ : Reverse supply polarity protection diode
 Z_{D1} : Surge absorption zener diode
 T_{r1} : PNP output transistor
 T_{r2} : NPN input transistor

Terminal arrangement diagram

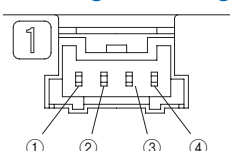

Terminal	Designation
①	+ V
②	Comparative output 1
③	Standard type: Comparative output 2 Multi-function type: Analog voltage output or External input
④	0 V

I/O CIRCUIT AND WIRING DIAGRAMS

DP-11□-E-P-J PNP output type

I/O circuit diagram

Standard type

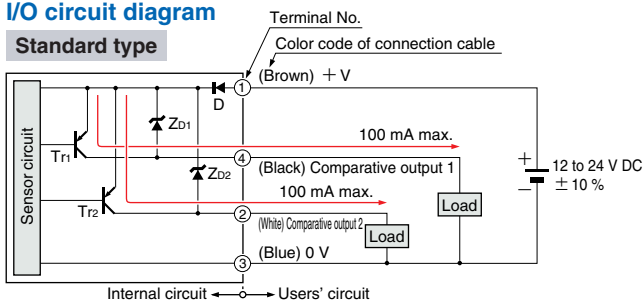

Symbols ... D : Reverse supply polarity protection diode
 Z_{D1}, Z_{D2} : Surge absorption zener diode
 Tr₁, Tr₂ : PNP output transistor

Multi-function type

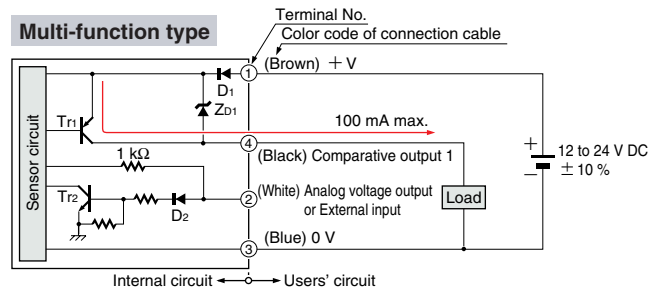

Symbols ... D₁, D₂ : Reverse supply polarity protection diode
 Z_{D1}, Z_{D2} : Surge absorption zener diode
 Tr₁ : PNP output transistor
 Tr₂ : NPN input transistor

Terminal arrangement diagram

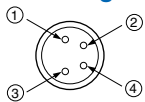

Terminal	Designation
①	+ V
②	Standard type: Comparative output 2 Multi-function type: Analog voltage output or External input
③	0 V
④	Comparative output 1

PRECAUTIONS FOR PROPER USE



- Never use this product as a sensing device for personnel protection.
- In case of using sensing devices for personnel protection, use products which meet laws and standards, such as OSHA, ANSI or IEC etc., for personnel protection applicable in each region or country.
- The DP-100 series is designed for use with non-corrosive gas. It cannot be used with liquid or corrosive gas.

Wiring

- Make sure that the power supply is off while wiring.
- Verify that the supply voltage variation is within the rating.
- If power is supplied from a commercial switching regulator, ensure that the frame ground (F.G.) terminal of the power supply is connected to an actual ground.
- In case noise generating equipment (switching regulator, inverter motor, etc.) is used in the vicinity of this sensor, connect the frame ground (F.G.) terminal of the equipment to an actual ground.
- Do not run the wires together with high-voltage lines or power lines or put them in the same raceway. This can cause malfunction due to induction.
- Incorrect wiring will cause problems with operation.

Connection

- Do not apply stress directly to the connection cable leader or to the connector.

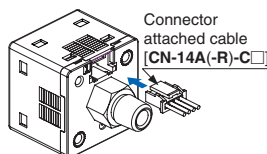

Conditions in use for CE conformity

- The DP-100 series is a CE conformity product complying with EMC Directive. The harmonized standard with regard to immunity that applies to this product is EN 61000-6-2 and the following condition must be met to conform to that standard.

Condition

- The sensor should be connected less than 10 m [32.808 ft](#) from the power supply.
- The signal line to connect with this sensor should be less than 30 m [98.425 ft](#).

Mounting

- MS-DP1-1 / MS-DP1-5 sensor mounting brackets are available separately, and it should be used for mounting. When tightening the sensor to the sensor mounting bracket, use a tightening torque of 0.5 N·m or less.

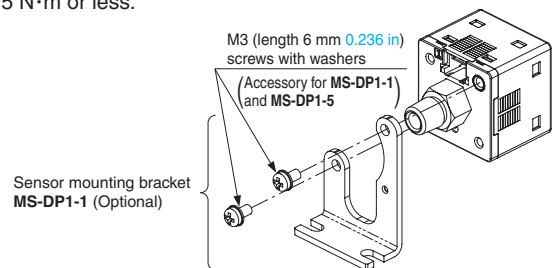

- The MS-DP1-2 panel mounting bracket (optional) and the MS-DP1-3 front protection cover (optional) are also available.

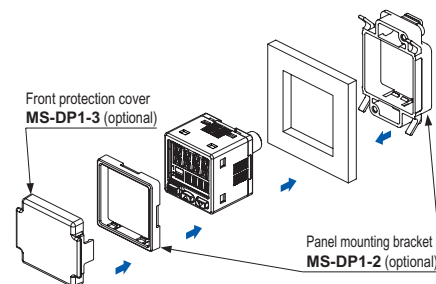

PRECAUTIONS FOR PROPER USE

Mounting

- The **MS-DP1-4** panel mounting bracket is available when switching from the **DP2 / DP3** series.

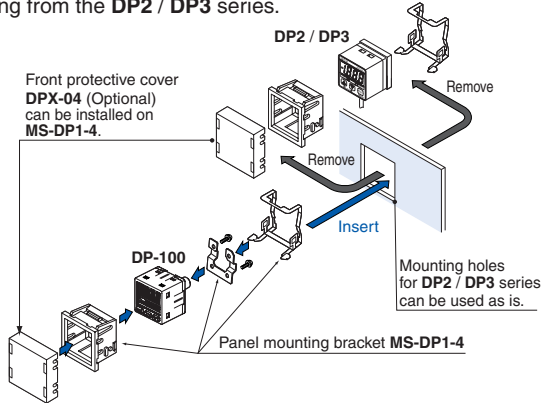

- An conversion bushing is available for when using the **DP-10□-M** short pressure port type. It can be used to switch between this model and the **DP2 / DP3** series. When connecting to the pressure port, use a tightening torque of 1.0 N·m or less.

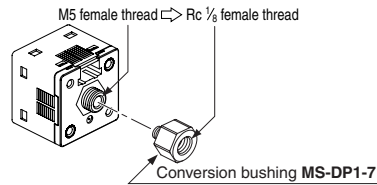

- The **MS-DP1-F□** flat attachment is available. If using the **MS-DP1-F□** flat attachment (optional), install by following the procedures given below.

① Decide the direction of this product to mount with the sensor.

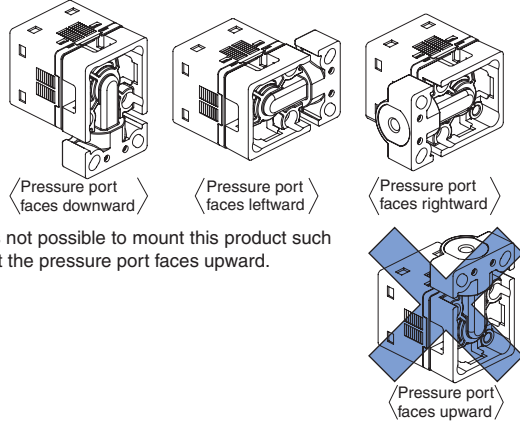

Note: It is not possible to mount this product such that the pressure port faces upward.

② Mount this product with the M3 female threads of the sensor by using the attached M3 (length 8 mm 0.315 in) screws. The tightening torque should be 0.5 N·m or less.

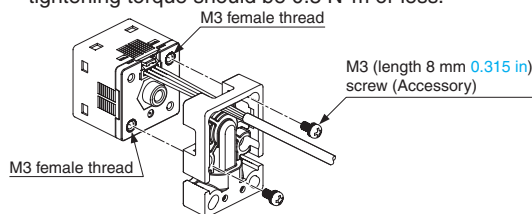

③ Mount this product with the mounting surface by using the attached M4 (length 20 mm 0.787 in) screws. The tightening torque should be 1.2 N·m or less.

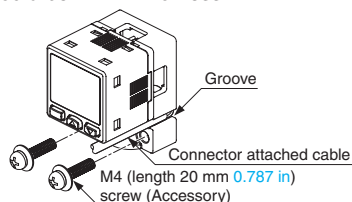

Note: Take care that if the cable with connector is sticking out of the side groove of this product when mounting, the cable may be disconnected.

Piping

- If connecting a commercially-available coupling to the pressure port, attach a 12 mm 0.472 in spanner (14 mm 0.551 in spanner for **DP-100-E** type) to the hexagonal section of the pressure port to secure it, and tighten at a torque of 9.8 N·m or less. If it is tightened using excessive torque, it may damage the coupling or the pressure port. In addition, wrap sealing tape around the coupling when connecting it to prevent leaks.

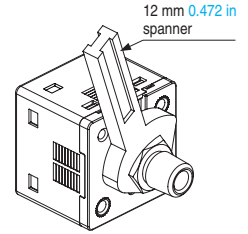

- If connecting a commercially-available joint to the pressure port of the **DP-10□-M**, hold the main unit in your hand to steady it, and tighten to a torque of 1.0 N·m or less. If it is tightened to an excessive torque, the joint or the main unit may become damaged.
- If connecting a commercially-available joint to the pressure port of the **MS-DP1-7**, tighten to a torque of 9.8 N·m or less.

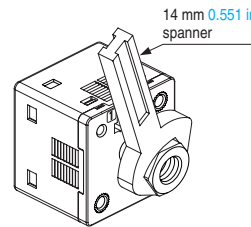

- The tightening torque should be 1 N·m or less when connecting a coupling to the pressure port of **MS-DP1-FM**.

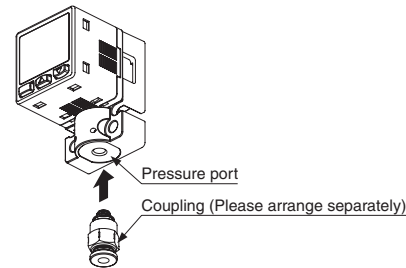

- When connecting the coupling to the pressure port of **MS-DP1-FR/FE/FN**, hold the pressure port with a 14 mm 0.551 in spanner and make sure that the tightening torque is 9.8 N·m or less. In addition, in order to prevent any leakage, wind a sealing tape on the coupling when connecting.

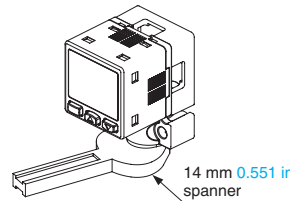

Note: Do not tighten the pressure port by holding the product with the spanner. It may cause the product breakage.

Flat attachment

- Make sure to mount **MS-DP1-F□** with the sensor properly. If it is not mounted properly, air leakage may occur.
- Take care that the excessive mounting and dismounting of this product may cause deterioration of the O-ring.
- If you touch the O-ring of **MS-DP1-F□**, or any scratch or dust, etc. is attached to it, air leakage may occur and the sensing performance may deteriorate. Take sufficient care when using and storing **MS-DP1-F□**.

PRECAUTIONS FOR PROPER USE

Others

- This product has been developed / produced for industrial use.
- Use within the rated pressure range.
- Do not apply pressure exceeding the pressure withstandability value. The diaphragm will get damaged and correct operation shall not be maintained.
- Do not use during the initial transient time (0.5 sec. approx.) after the power supply is switched on.
- Avoid dust, dirt, and steam.
- Take care that the sensor does not come in direct contact with water, oil, grease, or organic solvents, such as, thinner, etc.
- Do not insert wires, etc., into the pressure port. The diaphragm will get damaged and correct operation shall not be maintained.
- Do not operate the keys with pointed or sharp objects.

RUN mode

- This is the normal operating mode.

Setting item	Description
Threshold value setting	The threshold values for ON / OFF operation can be changed directly by pressing the increment key (UP) and the decrement key (DOWN).
Zero-adjustment function	This forces the pressure value display to be reset to zero when the pressure port is open on the atmospheric pressure side.
Key lock function	Stops key operations from being accepted.
Peak hold / bottom hold function	Displays the peak value and bottom value for fluctuating pressure. The peak value appears in the main display, and the bottom value appears in the sub display.

MENU SETTING mode

- If the mode selection key is pressed and held for 2 seconds in RUN mode, the mode will switch to MENU SETTING mode.
- If the mode selection key is pressed while a setting is being made, the mode will switch to RUN mode. In this case, the settings that have been changed will be entered.

Setting item	Description
Comparative output 1 output mode setting	Sets the output mode for comparative output 1.
Comparative output 2 output mode setting (standard type only)	Sets the output mode for comparative output 2.
Analog voltage output / external input switching (multi-function type only)	Allows switching between analog voltage output and auto-reference input / remote zero-adjustment input.
NO / NC switching	Sets normally open (NO) or normally closed (NC).
Response time setting	Sets the response time. The response time can be selected from 2.5 ms, 5 ms, 10 ms, 25 ms, 50 ms, 100 ms, 250 ms, 500 ms, 1,000 ms and 5,000 ms.
Display color switching for main display	Allows the color for the main display to be changed. The colors can be set to 'red / green' or 'green / red' to correspond to ON / OFF output, or it can be fixed at 'red' or 'green' all the time.
Unit switching (high pressure type only)	Pressure unit can be changed.

PRO mode

- If the mode selection key is pressed and held for 5 seconds in RUN mode, the mode will switch to PRO mode.
- If the mode selection key is pressed while a setting is being made, the mode will switch to RUN mode. In this case, the settings that have been changed will be entered.

Setting item	Description
Sub display switching	Changes the information in the sub display during RUN mode operation to the desired alphanumeric display.
Display refresh rate switching	Changes the display refresh rate for the pressure value displayed in the main display.
Hysteresis fix value switching	Sets the hysteresis for EASY mode and window comparator mode. (8 steps)
Linked display color switching (standard type only)	Allows the display color for the main display to be switched in line with the output operation for comparative output 1 or comparative output 2.
ECO mode setting	Allows power consumption to be reduced by dimming the display or turning it off.
Setting check code	Allows the setting details to be checked via codes.
Setting copy mode	Allows the setting details for the master sensor to be copied to slave sensors.
Reset setting	Resets the settings to the factory settings.

Table of codes

Code	1st digit		2nd digit			3rd digit	4th digit	
	Comparative output 1 output mode	NO / NC switching	Comparative output 2 output mode	NO / NC switching	Multi-function type		Threshold value display	Display color for main display
0	EASY	NO	OFF	OFF	Analog voltage output	P-1, Lo-1	Red when ON	Comparative output 1
1		NC	EASY	NO	Auto-reference			Hi-1
2	Hysteresis	NO		Hysteresis	NC	Remote zero-adjustment	P-2, Lo-2	Green when ON
3		NC	NO		—	Hi-2		
4	Window comparator	NO	Window comparator	NC	—	ADJ.	Always red	Comparative output 1
5		NC		NO	—			Comparative output 2
6	—	—	NC	—	—	—	Always green	Comparative output 1
7	—	—	—	—	—	—	Always green	Comparative output 2

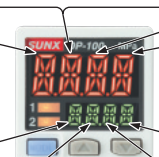

Code	5th digit	6th digit	7th digit	8th digit
	Response time	Unit switching	Display refresh rate	ECO mode
0	2.5 ms	MPa	250 ms	OFF
1	5 ms	kPa	500 ms	STD
2	10 ms	kgf/cm ²	1,000 ms	FULL
3	25 ms	bar	—	—
4	50 ms	psi	—	—
5	100 ms	mmHg	—	—
6	250 ms	inchHg	—	—
7	500 ms	—	—	—
8	1,000 ms	—	—	—
9	5,000 ms	—	—	—

DIMENSIONS (Unit: mm in)

The CAD data in the dimensions can be downloaded from the SUNX website: <http://www.sunx.com>

DP-10□ Sensor

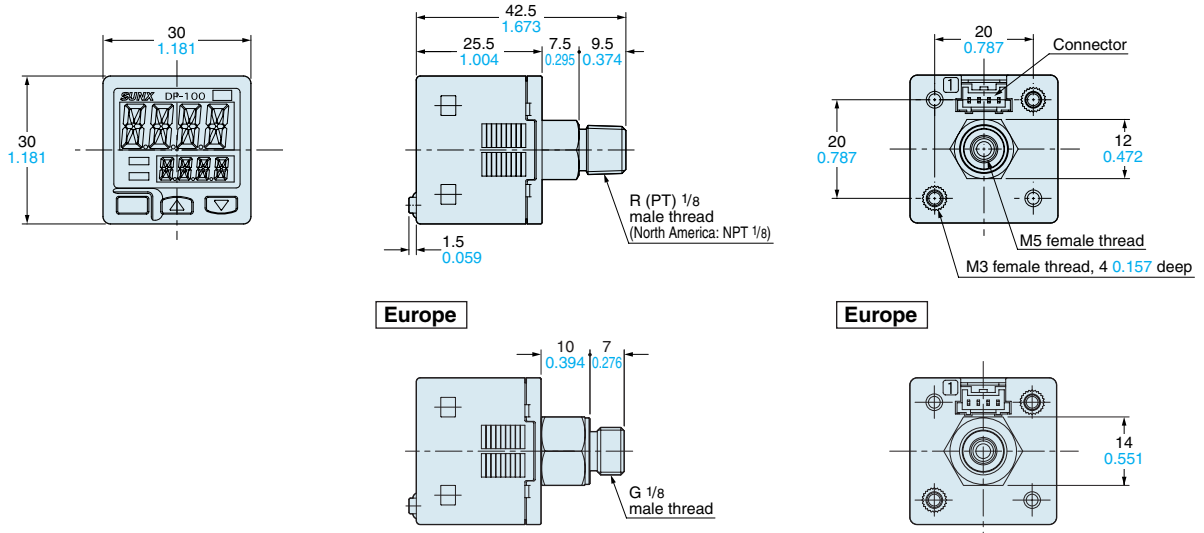

DP-10□-M(-P) Sensor

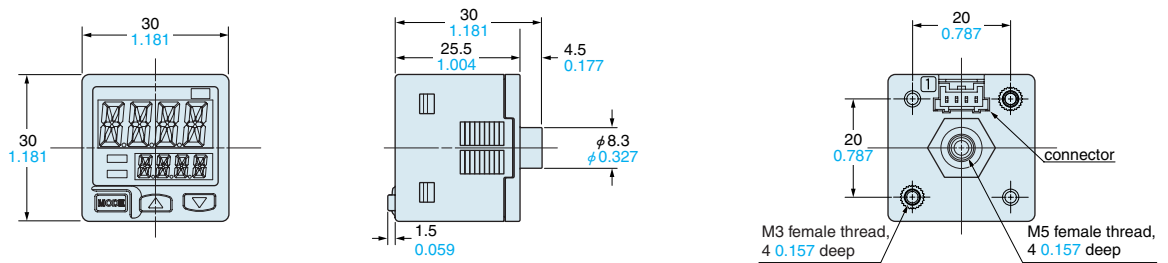

DP-11□-E-P-J Sensor

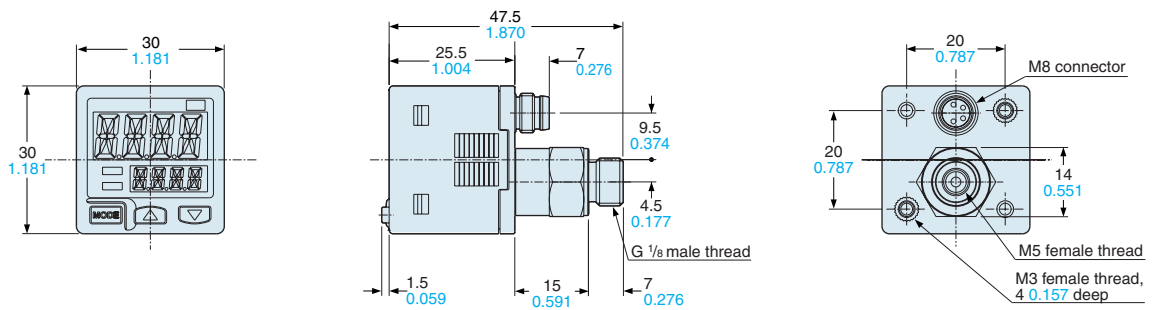

MS-DP1-1 Sensor mounting bracket (Optional)

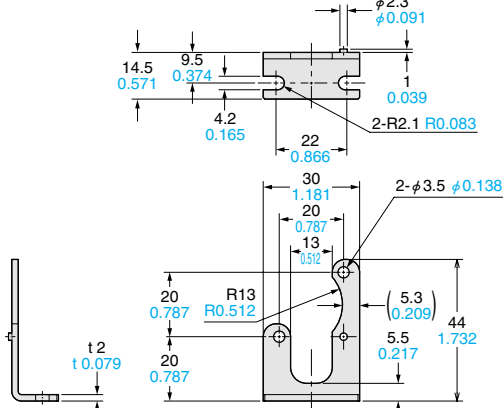

Material: Cold rolled carbon steel (SPCC)
(Uni-chrome plated)
Two M3 (length 6 mm 0.236 in) screws with washers are attached.

Assembly dimensions
Mounting drawing with DP-10□

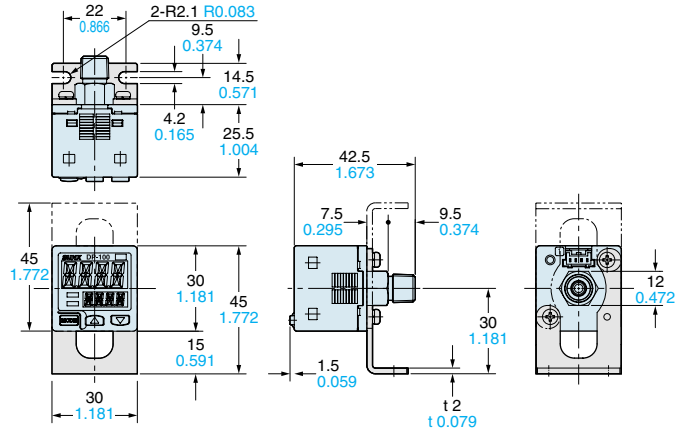

MS-DP1-5 Sensor mounting bracket (Optional)

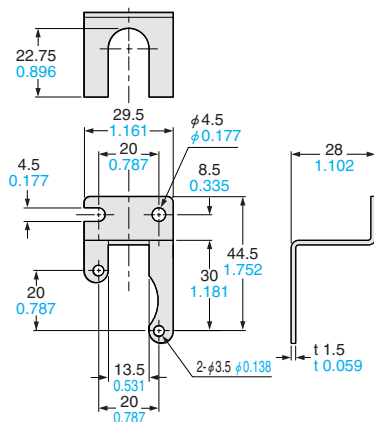

Material: Cold rolled carbon steel (SPCC)
(Uni-chrome plated)
Two M3 (length 6 mm 0.236 in) screws with washers are attached.

Assembly dimensions
Mounting drawing with DP-10□-M

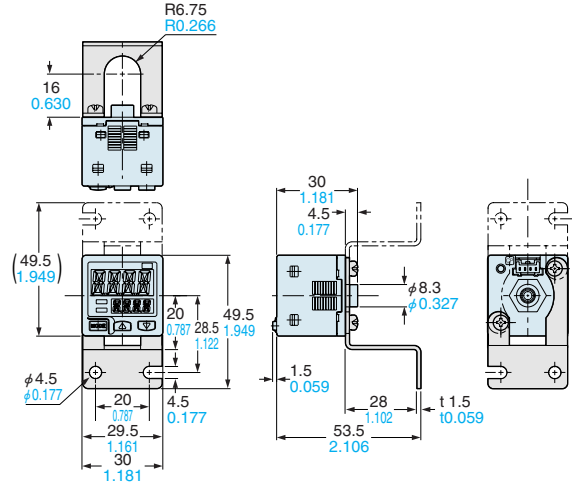

MS-DP1-2
MS-DP1-3 Panel mounting bracket (Optional), Front protection cover (Optional)

Assembly dimensions
Mounting drawing with DP-10□

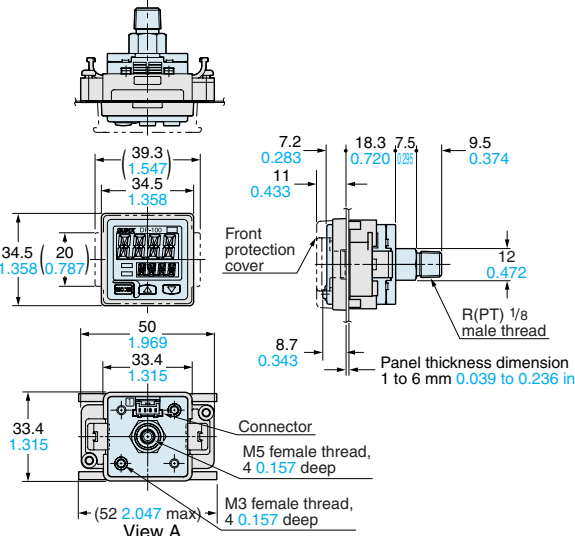

Material: POM (Panel mounting bracket)
Polycarbonate (Front protection cover)

Panel cut-out dimensions

When 1 unit is installed

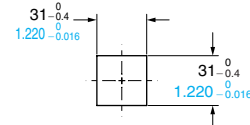

When "n" units are installed horizontally in series

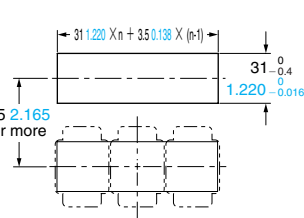

When "n" units are installed vertically in series

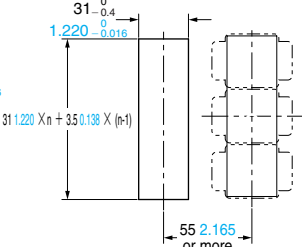

Note: The panel thickness should be 1 to 6 mm 0.039 to 0.236 in.

Note: The panel thickness should be 1 to 6 mm 0.039 to 0.236 in.

DIMENSIONS (Unit: mm in)

The CAD data in the dimensions can be downloaded from the SUNX website: <http://www.sunx.com>

MS-DP1-4 Panel mounting bracket (Optional)

Assembly dimensions

Mounting drawing with DP-10

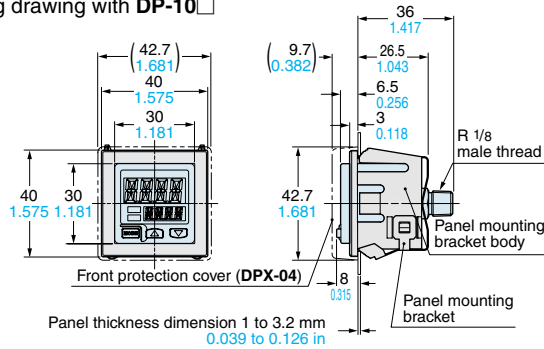

Panel cut-out dimensions

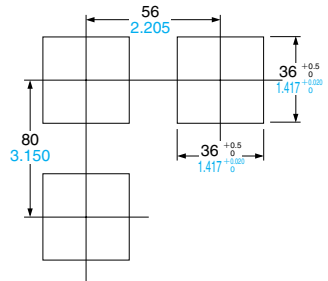

Note: The panel thickness should be 1 to 32 mm 0.039 to 1.260 in.

Material: Panel mounting bracket body ... Nylon 6
Panel mounting bracket ... Stainless steel (SUS304)
Spacer ... Cold rolled carbon steel (SPCC)(Uni-chrome plated)

MS-DP1-7 Conversion bushing (Optional)

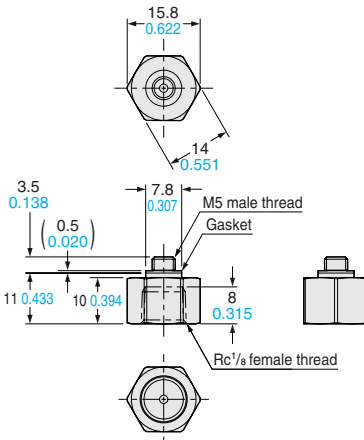

Material: Brass (Nickel plated)
Weight: 10 g approx.

MS-DP1-FM Flat attachment (Optional)

Assembly dimensions

Mounting drawing with DP-10-M

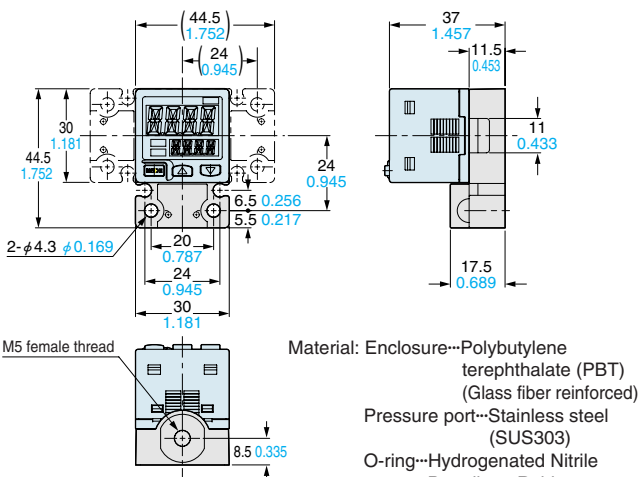

MS-DP1-FR/FN/FE Flat attachment (Optional)

Assembly dimensions

Mounting drawing with DP-10-M

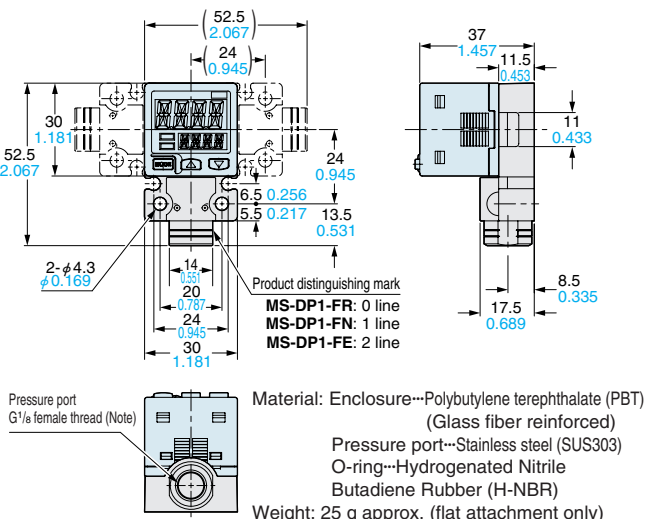

DIMENSIONS (Unit: mm in)

The CAD data in the dimensions can be downloaded from the SUNX website: <http://www.sunx.com>

CN-14A(-R)-C□ Connector attached cable (Optional, CN-14A-C2 is attached to the sensor)

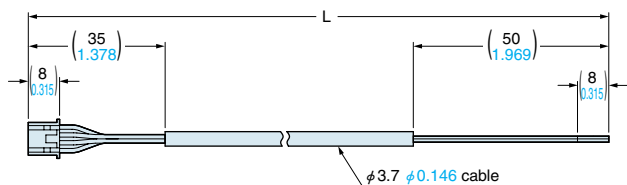

Model No.	Cable length L (mm in)
CN-14A(-R)-C1	1,000 39.370
CN-14A(-R)-C2	2,000 78.740
CN-14A(-R)-C3	3,000 118.110
CN-14A(-R)-C5	5,000 196.850

SC-SU1 Copy unit (Optional)

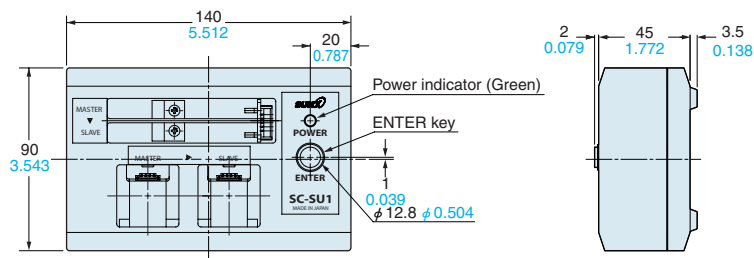
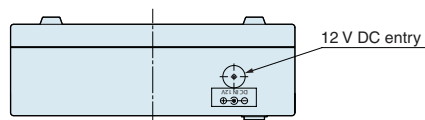

All information is subject to change without prior notice.



SUNX Limited

2431-1 Ushiyama-cho, Kasugai-shi, Aichi,
486-0901, Japan
Phone: +81-568-33-7211
FAX: +81-568-33-2631

Overseas Sales Dept.

Phone: +81-568-33-7861
FAX: +81-568-33-8591

<http://www.sunx.com>