

Features

- **Wide product range**
Shape: Standard type
Side view type
Connector: 2 m cable length type
M12 plug-in connector type
- **Diffuse reflective type sensor with sensitivity adjuster is available.**
- **M18 thread size for convenient mounting**
- **Strong resistance IP67**
- **Convenient universal sensor mounting stand is available.**

ORDER GUIDE

2 m cable length type

Type	Appearance	Sensing range	Model No. (Note 1)		Output operation
			NPN output	PNP output	
Standard		15 m 49.21 ft	CY-111A	CY-111A-P	Light-ON
			CY-111B	CY-111B-P	Dark-ON
		4 m 13.12 ft	CY-192A-Y	CY-192A-P-Y	Light-ON
			CY-192B-Y	CY-192B-P-Y	Dark-ON
		2 m 6.56 ft	CY-191A-Y	CY-191A-P-Y	Light-ON
			CY-191B-Y	CY-191B-P-Y	Dark-ON
		100 mm 0.33 ft	CY-121A	CY-121A-P	Light-ON
			CY-121B	CY-121B-P	Dark-ON
		600 mm 1.97 ft	CY-122A	CY-122A-P	Light-ON
			CY-122B	CY-122B-P	Dark-ON
Side view		15 m 49.21 ft	CY-111VA	CY-111VA-P	Light-ON
			CY-111VB	CY-111VB-P	Dark-ON
		4 m 13.12 ft	CY-192VA-Y	CY-192VA-P-Y	Light-ON
			CY-192VB-Y	CY-192VB-P-Y	Dark-ON
		2 m 6.56 ft	CY-191VA-Y	CY-191VA-P-Y	Light-ON
			CY-191VB-Y	CY-191VB-P-Y	Dark-ON
		100 mm 3.94 in	CY-121VA	CY-121VA-P	Light-ON
			CY-121VB	CY-121VB-P	Dark-ON
		600 mm 23.62 in	CY-122VA	CY-122VA-P	Light-ON
			CY-122VB	CY-122VB-P	Dark-ON

Notes: 1) The model No. with "E" shown on the label affixed to the thru-beam type sensor is the emitter, "D" shown on the label is the receiver.

(e.g.) Emitter of CY-111A: CY-111E, Receiver of CY-111A: CY-111AD

2) The reflector is sold separately.

3) The sensing range of the retroreflective type sensor is specified for the RF-420 reflector (optional).

M12 plug-in connector type

M12 plug-in connector type is also available.

When ordering this type, "-Z" for the M12 plug-in connector type to the model No.

(e.g.) M12 plug-in connector type of CY-111A-P is "CY-111A-P-Z".

• Standard type

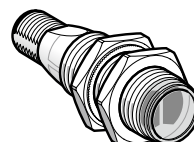

• Side view type

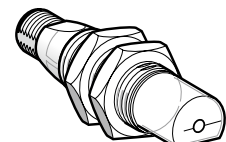

ORDER GUIDE

Mating cable (2 cables are required for the thru-beam type.)

Type		Model No.	Description	
For M12 plug-in connector type	Straight	CN-24C-C2	Length: 2 m 6.56 ft	Clamping ring : ø14mm 0.55 in
		CN-24C-C5	Length: 5 m 16.40 ft	
	Elbow	CN-24CL-C2	Length: 2 m 6.56 ft	Cable outer : ø5.3mm 0.21 in
		CN-24CL-C5	Length: 5 m 16.40 ft	

Mating cable

• Straight type

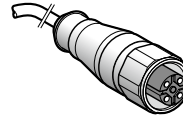

• Elbow type

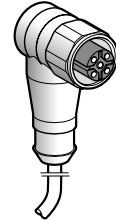

OPTIONS

Designation	Model No.	Description
Sensor mounting bracket	MS-CY1-1	Material: Stainless steel
	MS-CY1-2	Material: Plastic, For beam axis alignment
Universal sensor mounting stand	MS-AJ3	It can adjust the height of the sensor and reflector RF-420 . (The thru-beam type sensor needs two brackets.)
Reflector	RF-420	50 × 50 mm 1.97 × 1.97 in
	RF-410	24 × 21 mm 0.94 × 0.83 in
Reflective tape	RF-40RL5	22 mm × 5 m 0.87 × 196.85 in , Thickness: 0.4 mm 0.02 in

Sensor mounting bracket

• MS-CY1-1



• MS-CY1-2

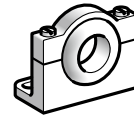

Universal sensor mounting stand

• MS-AJ3

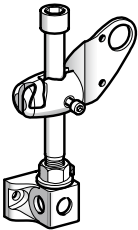

Reflector

• RF-420

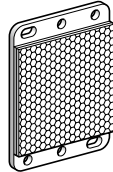

• RF-410

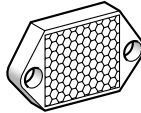

Reflective tape

• RF-40RL5

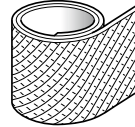

WIRING DIAGRAMS

Wiring diagram

Emitter of thru-beam type

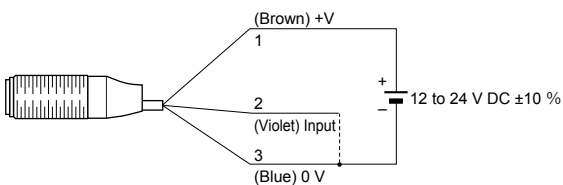

Receiver of thru-beam / Reflective type

NPN output type

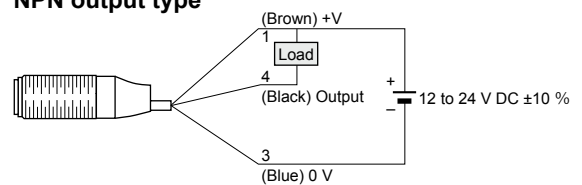

Receiver of thru-beam / Reflective type

PNP output type

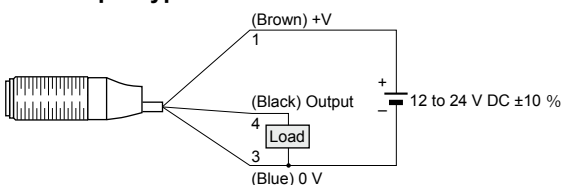

Connector pin position

M12 connector

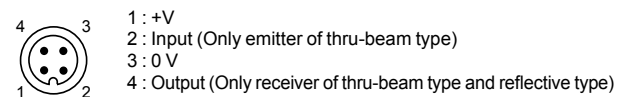

SPECIFICATIONS

Item	Model No.	Type	Thru-beam		Retroreflective				Diffuse reflective			
			Standard	Side view	Standard	Side view	With polarizing filters		Standard	Side view	With sensitivity adjuster	
							Standard	Side view			Standard	Side view
		Light-ON	CY-111A□	CY-111VA□	CY-192A□	CY-192VA□	CY-191A□	CY-191VA□	CY-121A□	CY-121VA□	CY-122A□	CY-122VA□
		Dark-ON	CY-111B□	CY-111VB□	CY-192B□	CY-192VB□	CY-191B□	CY-191VB□	CY-121B□	CY-121VB□	CY-122B□	CY-122VB□
Sensing range			15 m 49.21 ft		4 m 13.12 ft (Note 2)		2 m 6.56 ft (Note 2)		100 mm 3.94 in (Note 3)		600 mm 23.62 in (Note 3)	
Sensing object			ø18 mm ø0.71 in or more opaque object (Setting distance between emitter and receiver: 15 m 49.21ft)		ø50 mm ø1.97 in or more opaque, translucent or transparent object (Note 2, 4)		ø50 mm ø1.97 in or more opaque, translucent, transparent or specular object (Note 2, 4)		Opaque, translucent or transparent object (Note 4)			
Hysteresis			—————				3 to 15 % of operation distance (Note 3)					
Supply voltage			12 to 24 V DC ±10 % Ripple P-P 10 % or less									
Current consumption			Emitter: 35 mA or less Receiver: 35 mA or less		35 mA or less							
Output			<NPN output type> NPN open-collector transistor • Maximum sink current: 100 mA • Applied voltage: 24 V DC or less (between output and 0 V) • Residual voltage: 1.5 V or less				<PNP output type> PNP open-collector transistor • Maximum source current: 100 mA • Applied voltage: 24 V DC or less (between output and +V) • Residual voltage: 1.5 V or less					
Utilization category			DC-12 or DC-13									
Short-circuit protection			Incorporated									
Response time			1 ms or less									
Test input (emission halt) function			Incorporated		—————							
Operation indicator			Yellow LED (lights up when the output is ON) (incorporated on the receiver for thru-beam type)									
Power indicator			Green LED (lights up when the power is ON) (incorporated on the emitter)		—————							
Environmental resistance	Pollution degree		3 (Industrial environment)									
	Protection		IP67 (IEC)									
	Ambient temperature		-25 to +55 °C -13 to +131 °F (No dew condensation or icing allowed), Storage: -40 to +70 °C -22 to +158 °F									
	Ambient humidity		50 % RH (at +70 °C +158 °F)									
	Ambient illuminance		Incandescent light: 5,000 lx at the light-receiving face									
	EMC		EN 60947-5-2									
	Voltage withstandability		500 V AC for one min. between all supply terminals connected together and enclosure									
	Vibration resistance		10 to 55 Hz frequency, 0.5 mm 0.02 in amplitude in X, Y and Z directions for 1.5 hours each									
	Shock resistance		294 m/s ² acceleration (30 G approx.) in X, Y and Z directions for three times each									
Emitting element			Infrared LED (modulated)				Red LED (modulated)		Infrared LED (modulated)			
Peak emission wavelength			890 nm 0.04 mil		875 nm 0.03 mil		665 nm 0.03 mil		875 nm 0.03 mil			
Material			Enclosure: PBT, Lens: PMMA									
Cable (except for M12 plug-in connection type)			0.44 mm ² 3-core cabtyre cable, 2 m 6.56 ft long									
Cable extension			Extension up to total 10 m 32.81 ft is possible with 0.34 mm ² , or more, cable (thru-beam type: both emitter and receiver).									
Net weight (Note 5)	2 m cable length type		Emitter/ Receiver: 65 g approx.	Emitter/ Receiver: 70 g approx.	65 g approx.	70 g approx.	65 g approx.	70 g approx.	65 g approx.	70 g approx.	75 g approx.	
	M12 plug-in connector type		Emitter/ Receiver: 15 g approx.	Emitter/ Receiver: 20 g approx.	15 g approx.	20 g approx.	15 g approx.	20 g approx.	15 g approx.	20 g approx.	25 g approx.	
Accessories			Nut: 4 pcs.			Nut: 2 pcs.						

Notes: 1) Where measurement conditions have not been specified precisely, the conditions used were an ambient temperature of +23 °C **+73.4 °F**.
 2) The sensing range and the sensing object of the retroreflective type sensor are specified for the **RF-420** reflector (optional).
 3) The sensing range and the hysteresis of the diffuse reflective type sensor are specified for white non-glossy paper (200 × 200 mm **7.87 × 7.87 in**) as the object.
 4) Make sure to confirm detection with an actual sensor before use for detection of the transparent object and the translucent object.
 5) The weight includes the weight of nuts.

DETECTION CURVES

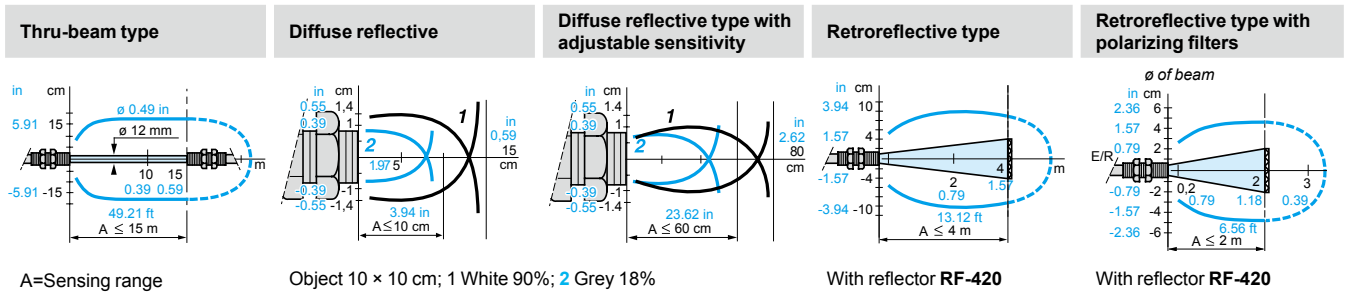

PRECAUTIONS FOR PROPER USE

- Never use this product as a sensing device for personnel protection.
- In case of using sensing devices for personnel protection, use products which meet laws and standards, such as OSHA, ANSI or IEC etc., for personnel protection applicable in each region or country.

Mounting

- The tightening torque should be 3 N·m or less.
- Use a cable with connector **CN-24C(L)-C□** (optional) for M12 connector type.
Tightening torque for connector part is 2 N·m or less.

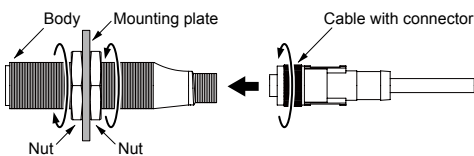

Mounting drawing with sensor or reflector RF-420

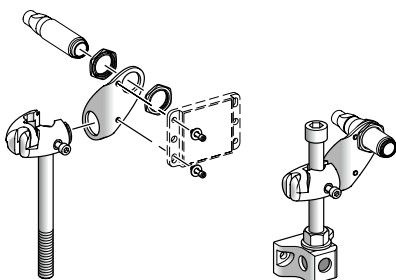

Wiring

- Make sure that the power supply is off while wiring.
- Verify that the supply voltage variation is within the rating.
- If power is supplied from a commercial switching regulator, ensure that the frame ground (F.G.) terminal of the power supply is connected to an actual ground.
- Ensure that an isolation transformer is utilized for the DC power supply. If an autotransformer is utilized, the main body or power supply may be damaged.
- If the used power supply generates a surge, connect a surge absorber to the power supply to absorb the surge.
- Do not use during the initial transient time (0.5 sec) after the power supply is switched on.
- In case noise generating equipment (switching regulator, inverter motor, etc.) is used in the vicinity of this product, connect the frame ground (F.G.) terminal of the equipment to an actual ground.
- Do not run the wires together with high-voltage lines or power lines or put them in the same raceway. This can cause malfunction due to induction.
- Damage or burnout may result in case of short circuit of load or miswiring.
- Make a cable length as short as possible to lessen noise pickup.

Others

- Our products have been developed / produced for industrial use only.
- Take care that the sensor is not directly exposed to fluorescent lamp from a rapid-starter lamp or a high frequency lighting device, as it may affect the sensing performance.
- Avoid using a product where there is excessive vapor, dust or corrosive gas, or in a place where it could be exposed directly to water or chemicals.
- Take care that the sensor does not come in direct contact with water, oil, grease or organic solvents, such as, thinner, etc.
- Do not use in an environment containing inflammable or explosive gases.
- Never disassemble or modify the product.

DIMENSIONS (Unit: mm in)

CY-1□ Sensor

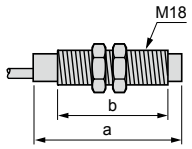

	2 m cable length type (mm in)		M12 plug-in connector type (mm in)	
	a	b	a	b
Standard type CY-111□/121□/192□	46 1.81	28 1.10	60 2.36	28 1.10
Standard type CY-191□	48 1.89	28 1.10	62 2.44	28 1.10
Side view type CY-111V□/121V□/191V□/192V□	62 2.44	28 1.10	76 2.99	28 1.10
Standard type CY-122□	62 2.44	44 1.73	76 2.99	44 1.73
Side view type CY-122V□	78 3.07	44 1.73	92 3.62	44 1.73

CN-24C-C2 CN-24C-C5 Mating cable

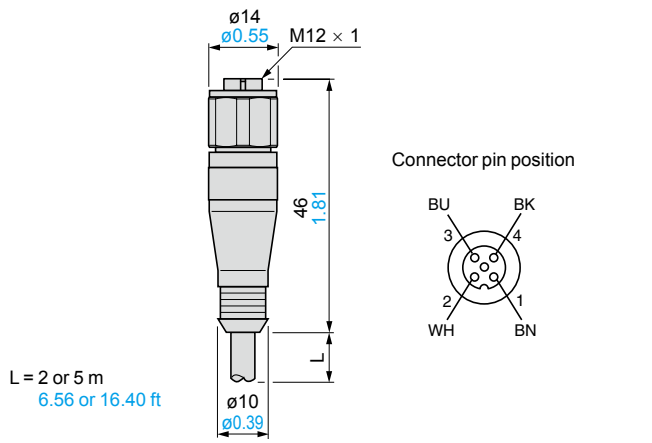

CN-24CL-C2 CN-24CL-C5 Mating cable

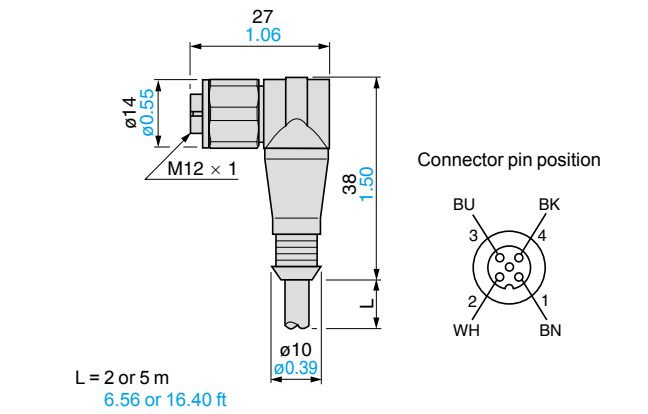

MS-CY1-1 Sensing mounting bracket

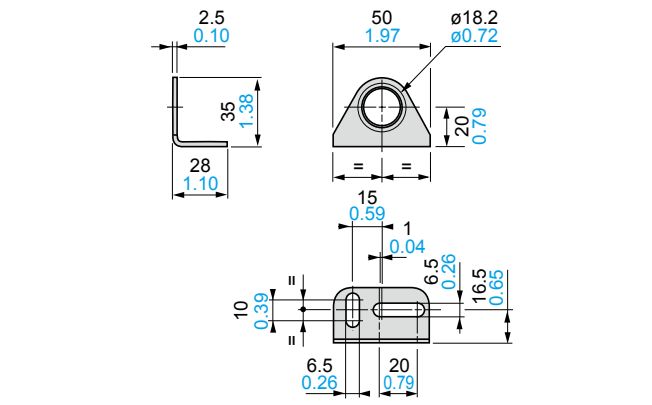

MS-CY1-2 Sensing mounting bracket

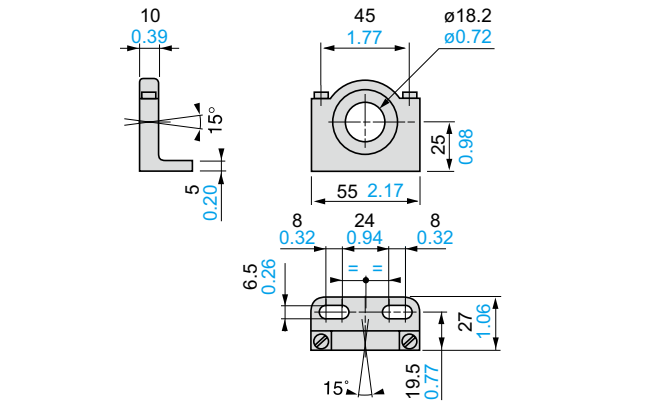

MS-AJ3 Universal sensor mounting stand

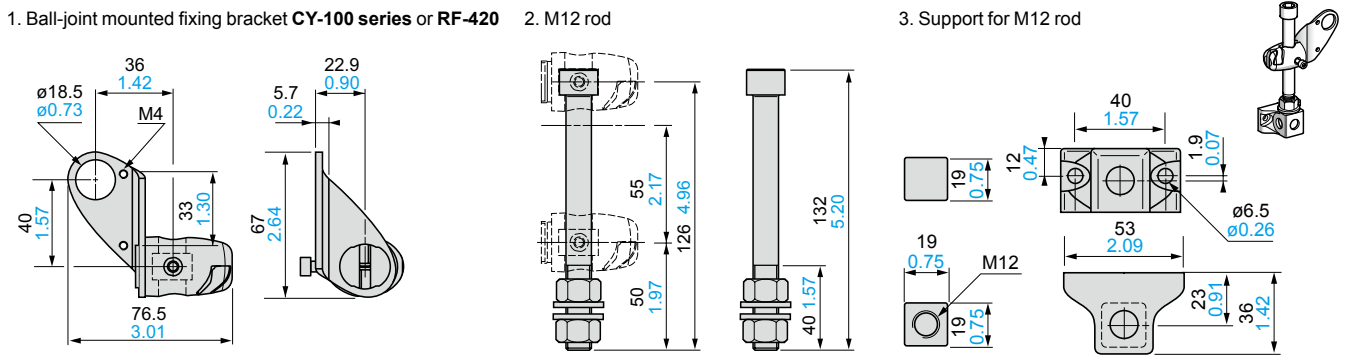

Disclaimer

The applications described in the catalog are all intended for examples only.

The purchase of our products described in the catalog shall not be regarded as granting of a license to use our products in the described applications.

We do NOT warrant that we have obtained some intellectual properties, such as patent rights, with respect to such applications, or that the described applications may not infringe any intellectual property rights, such as patent rights, of a third party.

Please contact

Panasonic Electric Works SUNX Co., Ltd.

2431-1 Ushiyama-cho, Kasugai-shi, Aichi, 486-0901, Japan

■Telephone: +81-568-33-7211 ■Facsimile: +81-568-33-2631

Global Sales & Marketing Division

■Telephone: +81-568-33-7861 ■Facsimile: +81-568-33-8591

panasonic-electric-works.net/sunx

The Panasonic logo, consisting of the word "Panasonic" in a bold, blue, sans-serif font, with a registered trademark symbol (®) to the upper right of the letter "c".

All Rights Reserved ©Panasonic Electric Works SUNX Co., Ltd. 2011