

Digital Fiber Sensor FX-300 SERIES

- FIBER SENSORS
- LASER SENSORS
- PHOTOELECTRIC SENSORS
- MICRO PHOTOELECTRIC SENSORS
- AREA SENSORS
- LIGHT CURTAINS
- PRESSURE / FLOW SENSORS
- INDUCTIVE PROXIMITY SENSORS
- PARTICULAR USE SENSORS
- SENSOR OPTIONS
- SIMPLE WIRE-SAVING UNITS
- WIRE-SAVING SYSTEMS
- MEASUREMENT SENSORS
- STATIC CONTROL DEVICES
- ENDOSCOPE
- LASER MARKERS
- PLC / TERMINALS
- HUMAN MACHINE INTERFACES
- ENERGY CONSUMPTION VISUALIZATION COMPONENTS
- FA COMPONENTS
- MACHINE VISION SYSTEMS
- UV CURING SYSTEMS

Related Information	■ General terms and conditions..... F-17	■ Sensor selection guide..... P.3~
	■ SC-GU1-485..... P.935~	■ Glossary of terms..... P.1359~
	■ General precautions P.1405	■ Korea's S-mark..... P.1410

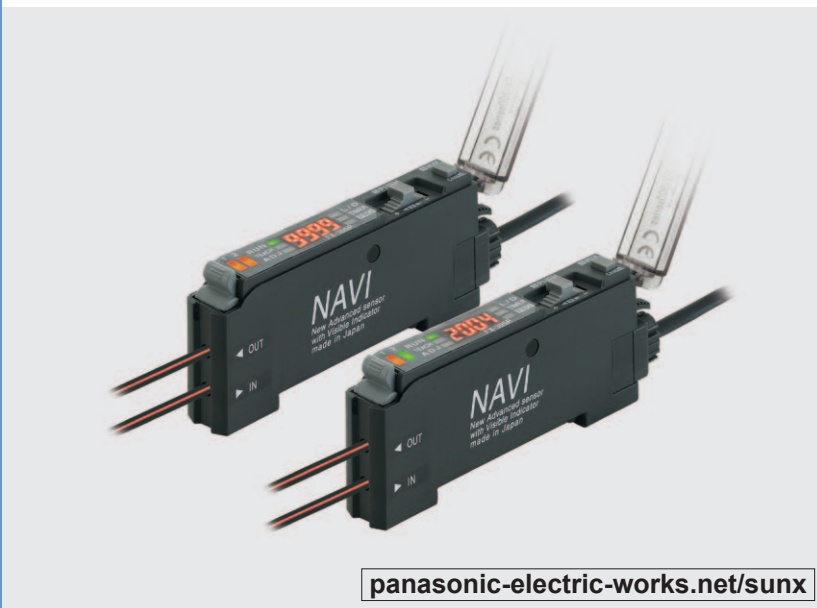

panasonic-electric-works.net/sunx



* Passed the UL 991 Environment Test

* UL 61010C-1 compatible, Passed the UL 991 Environment Test based on SEMI S2-0200. [Category applicable for semiconductor manufacturing: TWW2, Process Equipment] [Applicable standards: UL 61010C-1] [Additional test / evaluation standards as per intended use: UL 991, SEMI S2-0200]



Constant advances achieving significant improvement of sensing performance

The digital fiber sensor FX-301(P) has been modified since its production in June 2004.

Stable sensing over long and short periods FX-301 FX-301-HS FX-305

In addition to a "four-chemical emitting element" which suppresses changes in the light emitting element over time so that a stable level of light emission can be maintained over long periods, a "APC (Auto Power Control) circuit" has also been adopted afreshly. The light emitting amount can be controlled in minute degrees so that even changes occurring over very short periods can be handled, allowing stable sensing performance by suppressing deviations in light emitting amounts caused by changes in the ambient environment that could not previously be suppressed.

Stable sensing comparison

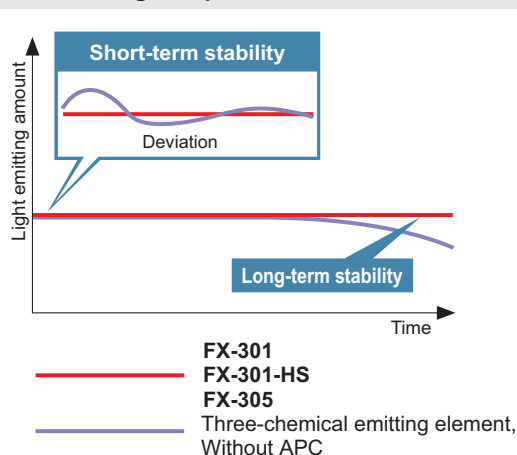

Even greater sensing range All models

Adoption of a "double coupling lens" that increases emission efficiency to its maximum limits and greatly increases sensing range. Sensing ranges with small diameter fibers and ultra-small diameter fibers, which have become very popular due to the miniaturization of chip components, have been increased by 50 % over previous values achieved with other amplifiers.

Conventional fiber sensors (Without lens)

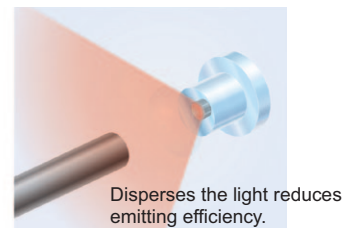

Double coupling lens

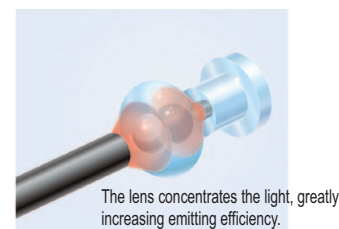

- Selection Guide
- Fibers
- Amplifiers
- FX-500
- FX-100
- FX-300
- FX-410
- FX-311
- FX-301-F7/ FX-301-F

APPLICATIONS

Detecting the presence or absence of labels

The light-emitting amount selection function can even stabilize detection of transparent labels that saturate the light-receiving level.

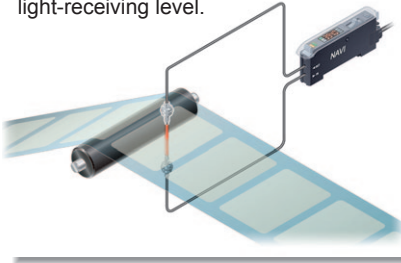

Detecting the presence or absence of ICs on a tray

You can set upper and lower limits for the threshold values using the window comparator mode and turn ON / OFF the incident light intensity within that limit.

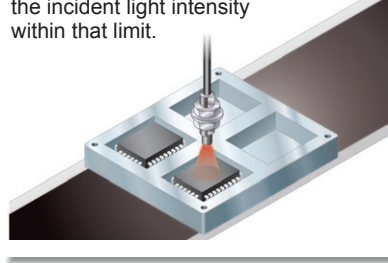

Detecting the passage of small objects

The differential sensing mode will only detect rapid changes in the amount of light, which makes it possible for small objects to be detected.

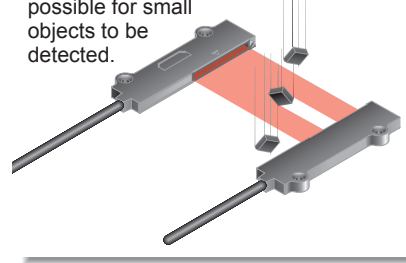

Light-emitting amount selection

FX-301 **FX-301-HS** **FX-305**

If the light receiving level becomes saturated during close-range sensing or when sensing transparent or minute objects, you can adjust the light emitting amount of the sensor to stabilize sensing **without needing to change the response time**. Sensing that previously required the response time or fibers to be changed can now be set much more easily using this function.

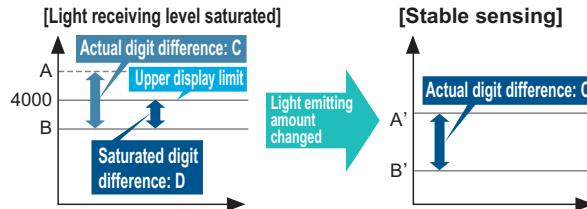

Light emitting amount can be changed without changing response time

Large display 9999

FX-305

Large display with 4 digits (9999). With a greater difference in digit value than previous models, threshold values can be set in units of 1 digit up to maximum 9999. Threshold setting can now be done more easily and accurately.



2.5 times previous models

(During STDF, LONG and U-LG modes)

Ultra high-speed 35 μs response

FX-301-HS

Ultra high-speed 35 μs response. Even small objects moving at high speeds can be sensed. In addition, at 65 μs the **FX-301** standard type and **FX-305** high-function type is also twice as fast as previous models.

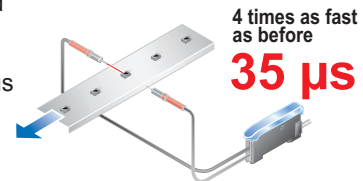

Digit difference comparison

Example Digit difference between **object A** and **object B**

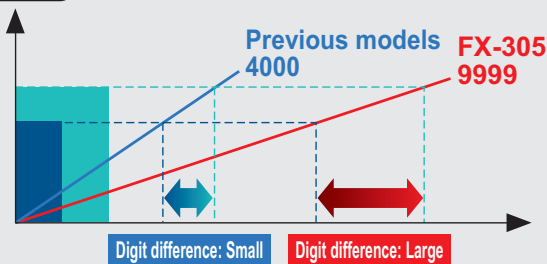

Ultra high-speed type FX-301-HS



Standard type FX-301, High-function type FX-305



Previous model



FIBER SENSORS

LASER SENSORS

PHOTOELECTRIC SENSORS

MICRO PHOTOELECTRIC SENSORS

AREA SENSORS

LIGHT CURTAINS

PRESSURE / FLOW SENSORS

INDUCTIVE PROXIMITY SENSORS

PARTICULAR USE SENSORS

SENSOR OPTIONS

SIMPLE WIRE-SAVING UNITS

WIRE-SAVING SYSTEMS

MEASUREMENT SENSORS

STATIC CONTROL DEVICES

ENDOSCOPE

LASER MARKERS

PLC / TERMINALS

HUMAN MACHINE INTERFACES

ENERGY CONSUMPTION VISUALIZATION COMPONENTS

FA COMPONENTS

MACHINE VISION SYSTEMS

UV CURING SYSTEMS

Selection Guide

Fibers

Amplifiers

FX-500

FX-100

FX-300

FX-410

FX-311

FX-301-F7/

FX-301-F

FIBER SENSORS

LASER SENSORS

PHOTOELECTRIC SENSORS

MICRO PHOTOELECTRIC SENSORS

AREA SENSORS

LIGHT CURTAINS

PRESSURE / FLOW SENSORS

INDUCTIVE PROXIMITY SENSORS

PARTICULAR USE SENSORS

SENSOR OPTIONS

SIMPLE WIRE-SAVING UNITS

WIRE-SAVING SYSTEMS

MEASUREMENT SENSORS

STATIC CONTROL DEVICES

ENDOSCOPE

LASER MARKERS

PLC / TERMINALS

HUMAN MACHINE INTERFACES

ENERGY CONSUMPTION VISUALIZATION COMPONENTS

FA COMPONENTS

MACHINE VISION SYSTEMS

UV CURING SYSTEMS

Selection Guide

Fibers

Amplifiers

FX-500

FX-100

FX-300

FX-410

FX-311

FX-301-F7/
FX-301-F

Simplified systems using new operating modes

FX-305

A window comparator mode and differential sensing mode have been added. These modes make it easy to carry out sensing tasks that previously required multiple sensors or involved complex threshold settings.

• **Window comparator mode**



<Sensing ICs in trays>

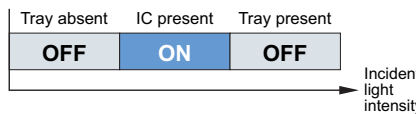
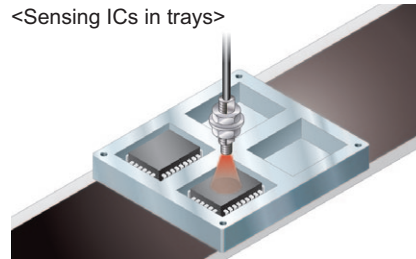

Upper and lower limits for threshold values can be set so that the incident light intensity can turn on and off within those ranges. Single output is used, so that only one cable is required, and no PLC processing is required either.

• **Differential sensing mode**



<Sensing of tiny moving objects>

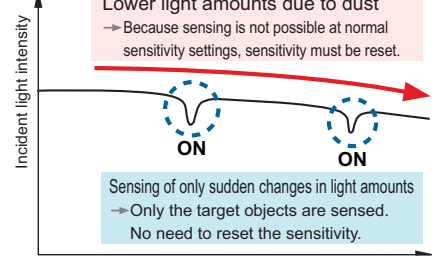
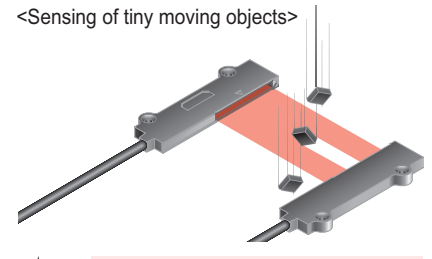

Equipped with 5 types timers

FX-305

The **FX-305** includes the same ON-delay / OFF-delay / ONE SHOT timer as the **FX-301(-HS)**, as well as an ON-delay • OFF-delay timer and an ON-delay • ONE SHOT timer. A wide variety of timer control operations can be carried out by these fiber sensors alone.

Timer period
Output 1: 0.5 to 9,999 ms (variable)
Output 2: 0.5 to 500 ms (variable)

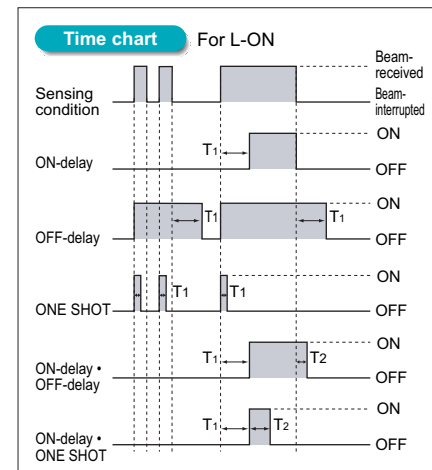

Even beginners can quickly learn how to use the MODE NAVI

All models

MODE NAVI uses six indicators to display the amplifier's basic operations. The current operating mode can be confirmed at a glance, so even a first time user can easily operate the amplifier without becoming confused.

RUN (Green)	RUN → This is the sensing mode. Incident light level is displayed in the digital display.
TEACH (Grey)	TEACH → This mode is for setting the threshold value.
ADJ (Grey)	ADJ → In this mode, the threshold value, once set, may be fine-tuned.



L / D (Yellow)	L / D ON → This mode allows the selection of output operation as either Light-ON or Dark-ON.
TIMER (Yellow)	TIMER → This mode permits the choice of using or not using the timer.
PRO (Grey)	PRO → This mode allows the selection of further advanced functions, such as the copying of individual settings and the memory functions.

Easy confirming of threshold value settings

FX-301 FX-301-HS FX-305

The threshold value can be confirmed by turning the jog switch even during RUN mode.

Jog switch is turned

Left: **FX-301(-HS)** Right: Output 2 for **FX-305**

The threshold value is displayed

The use of only two switches makes for very simple operations

All models

Only two switches, the large jog switch and the large MODE key, are required for operation. You can operate it simply by the 3 steps shown on the right.

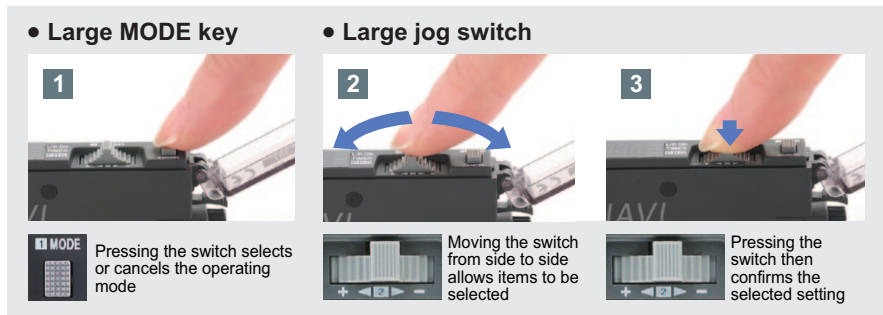

A quick-connection cable saves wiring and work-hours

Connector type

One unit can be used as either a main unit or sub unit

The amplifier unit can be used as either a main unit or a sub unit. This feature allows for easy mounting in the side-by-side configuration. The main and sub unit functions are distinguished only by the proper use of the main cable and the sub cable. Moreover, inventory management and maintenance is simplified.

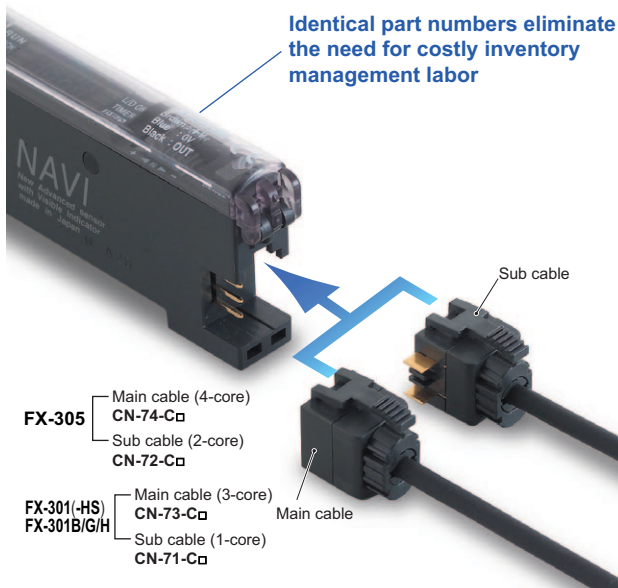

An optical communication function allows up to *16 sensors to be adjusted simultaneously

FX-301 | FX-305

The optical communication function allows the data that is currently set to be copied and saved all at once for all amplifiers connected together from the right side. This greatly reduces troublesome setup tasks and makes setup much smoother. In addition, troublesome adjustment operations at times such as when replacing sensors can also be carried out easily and data can also be copied and stored using the optical communication function.



* Use the optical communication function for only the same types of sensors. Furthermore, the FX-301-HS is not equipped with optical communication function capability.

Settings can be entered directly using numerical input

All models

Every function can be directly set merely by the input of a four digit code (numbers) from the code table. This convenient feature is easy to set up. In the event that settings are accidentally changed at the operating site, merely entering the correct code can restore the original settings. This results in easy and quick maintenance.

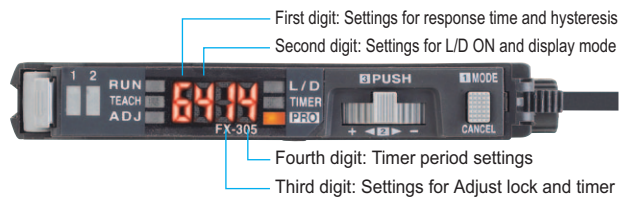

Communication unit improves equipment starting up and maintenance

FX-301 | FX-305

External input unit for digital sensor

FX-CH2

Teaching and changing settings can be performed by using the PLC and touch panel.

Various settings and switching of up to 16 units of digital fiber sensors can be accomplished at once without operating the actual sensors themselves, but via external signals, such as the PLC, touch panel, and push buttons.

<Main functions>

- Batch teaching
- Key lock setting
- Batch loading / saving of the data bank



Refer to our website for details

Upper communication unit for digital sensor

SC-GU1-485

We now offer remote maintenance for digital sensors!

The communication unit enables inputs to the digital fiber sensors (such as teaching and data bank switching) to be carried out via a PLC or a personal computer, and also allows confirming of the incident light intensity an output status for the fiber sensors. This greatly improves workability during equipment starting up and maintenance.

<Communicable commands>

- Sensor incident light intensity
- Sensor settings verification
- Sensor output status
- Threshold value settings, etc.

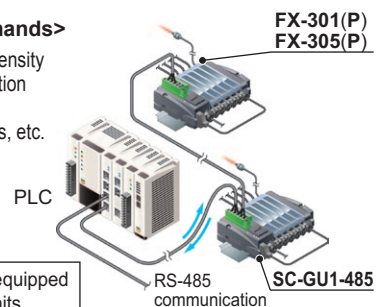

Compatible with all PLCs equipped with RS-485 compatible units

Refer to **SC-GU1-485** pages for details

FIBER SENSORS

LASER SENSORS

PHOTOELECTRIC SENSORS

MICRO PHOTOELECTRIC SENSORS

AREA SENSORS

LIGHT CURTAINS

PRESSURE / FLOW SENSORS

INDUCTIVE PROXIMITY SENSORS

PARTICULAR USE SENSORS

SENSOR OPTIONS

SIMPLE WIRE-SAVING UNITS

WIRE-SAVING SYSTEMS

MEASUREMENT SENSORS

STATIC CONTROL DEVICES

ENDOSCOPE

LASER MARKERS

PLC / TERMINALS

HUMAN MACHINE INTERFACES

ENERGY CONSUMPTION VISUALIZATION COMPONENTS

FA COMPONENTS

MACHINE VISION SYSTEMS

UV CURING SYSTEMS

Selection Guide

Fibers

Amplifiers

FX-500

FX-100

FX-300

FX-410

FX-311

FX-301-F7/ FX-301-F

ORDER GUIDE**Amplifiers** Quick-connection cable is not supplied with the amplifier. Please order it separately.

Type	Appearance	Model No.	Emitting element	Output	Quick-connection cables				
					Type	Model No.	Length		
Standard type		FX-301	Red LED	NPN open-collector transistor	Main cable (3-core)	CN-73-C1	1 m 3.281 ft		
		FX-301P		PNP open-collector transistor					
		FX-301B	Blue LED	NPN open-collector transistor		CN-73-C2	2 m 6.562 ft		
		FX-301BP		PNP open-collector transistor					
		FX-301G	Green LED	NPN open-collector transistor		CN-73-C5	5 m 16.404 ft		
		FX-301GP		PNP open-collector transistor					
		FX-301H	Infrared LED	NPN open-collector transistor	CN-71-C1	1 m 3.281 ft			
		FX-301HP		PNP open-collector transistor					
		High-speed type		FX-301-HS	Red LED	NPN open-collector transistor	Sub cable (1-core)	CN-71-C2	2 m 6.562 ft
				FX-301P-HS		PNP open-collector transistor			
High-function type		FX-305	Red LED	NPN open-collector transistor	Main cable (4-core)	CN-74-C1	1 m 3.281 ft		
		FX-305P		PNP open-collector transistor		CN-74-C2	2 m 6.562 ft		
							CN-74-C5	5 m 16.404 ft	
							Sub cable (2-core)	CN-72-C1	1 m 3.281 ft
								CN-72-C2	2 m 6.562 ft
								CN-72-C5	5 m 16.404 ft

ORDER GUIDE

Quick-connection cables

For FX-301(-HS)/B/G/H Quick-connection cable is not supplied with the amplifier. Please order it separately.

Type	Model No.	Description
Main cable (3-core)	CN-73-C1	Length: 1 m 3.281 ft
	CN-73-C2	Length: 2 m 6.562 ft
	CN-73-C5	Length: 5 m 16.404 ft
Sub cable (1-core)	CN-71-C1	Length: 1 m 3.281 ft
	CN-71-C2	Length: 2 m 6.562 ft
	CN-71-C5	Length: 5 m 16.404 ft

0.15 mm² 3-core cabtyre cable, with connector on one end
Cable outer diameter: ø3.0 mm ø0.118 in

0.15 mm² 1-core cabtyre cable, with connector on one end
Cable outer diameter: ø3.0 mm ø0.118 in

Main cable

- **CN-73-C□**

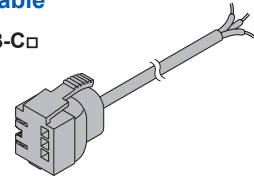

Sub cable

- **CN-71-C□**

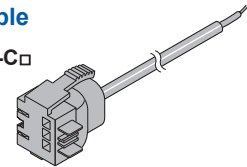

For FX-305 Quick-connection cable is not supplied with the amplifier. Please order it separately.

Type	Model No.	Description
Main cable (4-core)	CN-74-C1	Length: 1 m 3.281 ft
	CN-74-C2	Length: 2 m 6.562 ft
	CN-74-C5	Length: 5 m 16.404 ft
Sub cable (2-core)	CN-72-C1	Length: 1 m 3.281 ft
	CN-72-C2	Length: 2 m 6.562 ft
	CN-72-C5	Length: 5 m 16.404 ft

0.15 mm² 4-core cabtyre cable, with connector on one end
Cable outer diameter: ø3.0 mm ø0.118 in

0.15 mm² 2-core cabtyre cable, with connector on one end
Cable outer diameter: ø3.0 mm ø0.118 in

Main cable

- **CN-74-C□**

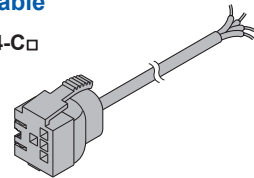

Sub cable

- **CN-72-C□**

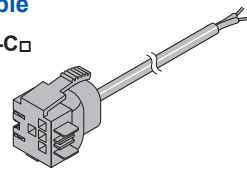

End plates End plates are not supplied with the amplifier. Please order them separately when the amplifiers are mounted in cascade.

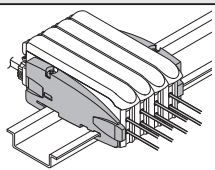
Appearance	Model No.	Description
	MS-DIN-E	When cascading multiple amplifiers, or when it moves depending on the way it is installed on a DIN rail, these end plates clamp amplifiers into place on both sides. Make sure to use end plates when cascading multiple amplifiers together. Two pcs. per set

OPTIONS

Designation	Model No.	Description
Amplifier mounting bracket	MS-DIN-2	Mounting bracket for amplifier
Fiber amplifier protection seal	FX-MB1	10 sets of 2 communication window seals and 1 connector seal Communication window seal: It prevents malfunction due to transmission signal from another amplifier, as well as, prevents effect on another amplifier. Connector seal: It prevents contact of any metal, etc., with the pins of the quick-connection cable.

Note: Fiber amplifier protection seals are supplied with the **FX-301(P)** and **FX-305(P)**.

Amplifier mounting bracket

- **MS-DIN-2**

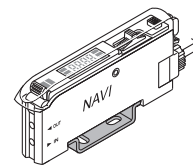

Fiber amplifier protection seal

- **FX-MB1**

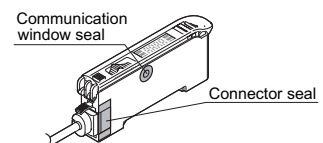

FIBER SENSORS

LASER SENSORS

PHOTO-ELECTRIC SENSORS

MICRO PHOTO-ELECTRIC SENSORS

AREA SENSORS

LIGHT CURTAINS

PRESSURE / FLOW SENSORS

INDUCTIVE PROXIMITY SENSORS

PARTICULAR USE SENSORS

SENSOR OPTIONS

SIMPLE WIRE-SAVING UNITS

WIRE-SAVING SYSTEMS

MEASUREMENT SENSORS

STATIC CONTROL DEVICES

ENDSCOPE

LASER MARKERS

PLC / TERMINALS

HUMAN MACHINE INTERFACES

ENERGY CONSUMPTION VISUALIZATION COMPONENTS

FA COMPONENTS

MACHINE VISION SYSTEMS

UV CURING SYSTEMS

Selection Guide

Fibers

Amplifiers

FX-500

FX-100

FX-300

FX-410

FX-311

FX-301-F7/

FX-301-F

LIST OF FIBERS**FX-301 / FX-305 (Red LED type) sensing range (Note 1)****Thru-beam type (one pair set)**

The **FX-305** and **FX-301(-HS)** have different sensing modes.

FX-305: H-SP, FAST, STD, STDF, LONG, U-LG (no S-D mode)

FX-301(-HS): S-D, H-SP (Note 1), FAST, STD, LONG (no STDF or U-LG mode)

Fibers are listed in alphabetic order. Refer to p.5~ "Fiber Selection" for details of each fiber.

Model No.	Sensing range (mm in) (Note 2)							Dimensions
	Red LED							
	U-LG	LONG	STDF	STD	FAST	H-SP	S-D	
FT-30	450 17.717	310 12.205	210 8.268	150 5.906	110 4.331	60 2.362	60 2.362	P.90
FT-31	440 17.323	290 11.417	200 7.874	142 5.591	105 4.134	58 2.283	49 1.929	P.90
FT-40	1,300 51.181	900 35.433	600 23.622	450 17.717	330 12.992	180 7.087	180 7.087	P.90
FT-41	1,000 39.370	780 30.709	500 19.685	400 15.748	280 11.024	150 5.906	130 5.118	P.90
FT-42	1,100 43.307	800 31.496	550 21.654	400 15.748	285 11.220	160 6.299	150 5.906	P.90
FT-A8	3,500 137.795 (Note 3)	3,500 137.795 (Note 3)	3,300 129.921	1,500 59.055	1,100 43.307	1,080 42.520	750 29.528	P.90
FT-A30	3,500 137.795 (Note 3)	3,500 137.795 (Note 3)	3,500 137.795 (Note 3)	3,500 137.795 (Note 3)	3,500 137.795 (Note 3)	3,000 118.110	3,500 137.795 (Note 3)	P.90
FT-AFM2	850 33.465	650 25.591	380 14.961	330 12.992	220 8.661	100 3.937	115 4.528	P.90
FT-AFM2E	800 31.496	590 23.228	350 13.780	290 11.417	200 7.874	90 3.543	100 3.937	P.90
FT-B8	1,600 62.992	1,100 43.307	700 27.559	530 20.866	400 15.748	200 7.874	180 7.087	P.90
FT-E12	20 0.787	18 0.709	13 0.512	10 0.394	8 0.315	3 0.118	3 0.118	P.91
FT-E13	20 0.787	13 0.512	9 0.354	6 0.236	5 0.197	2 0.079	2 0.079	P.91
FT-E22	130 5.118	80 3.150	60 2.362	50 1.969	36 1.417	18 0.709	15 0.591	P.91
FT-E23	95 3.740	65 2.559	42 1.654	31 1.220	22 0.866	12 0.472	12 0.472	P.91
FT-FM2	1,000 39.370	780 30.709	500 19.685	400 15.748	280 11.024	150 5.906	130 5.118	P.91
FT-FM2S	1,000 39.370	780 30.709	500 19.685	400 15.748	280 11.024	150 5.906	130 5.118	P.91
FT-FM2S4	1,000 39.370	780 30.709	500 19.685	400 15.748	280 11.024	150 5.906	130 5.118	P.91
FT-FM10L	19,500 767.717 (Note 4)	19,500 767.717 (Note 4)	19,500 767.717 (Note 4)	14,000 551.180	10,000 393.700	3,500 137.795	3,800 149.606	P.91
FT-H13-FM2	1,200 47.244	880 34.646	550 21.654	440 17.323	300 11.811	150 5.906	155 6.102	P.91
FT-H20-J20-S (Note 5)	530 20.866	390 15.354	225 8.858	200 7.874	140 5.512	60 2.362	60 2.362	P.92
FT-H20-J30-S (Note 5)	530 20.866	390 15.354	225 8.858	200 7.874	140 5.512	60 2.362	60 2.362	P.92
FT-H20-J50-S (Note 5)	530 20.866	390 15.354	225 8.858	200 7.874	140 5.512	60 2.362	60 2.362	P.92
FT-H20-M1	750 29.528	550 21.654	320 12.598	280 11.024	200 7.874	85 3.346	90 3.543	P.92
FT-H20-VJ50-S (Note 5)	840 33.071	550 21.654	370 14.567	280 11.024	200 7.874	90 3.543	90 3.543	P.92
FT-H20-VJ80-S (Note 5)	840 33.071	550 21.654	370 14.567	280 11.024	200 7.874	90 3.543	90 3.543	P.92
FT-H20W-M1	420 16.535	310 12.205	180 7.087	140 5.512	100 3.937	40 1.575	50 1.969	P.92
FT-H30-M1V-S (Note 6)	350 13.780	250 9.843	150 5.906	125 4.921	90 3.543	50 1.969	40 1.575	P.92
FT-H35-M2	750 29.528	550 21.654	330 12.992	280 11.024	200 7.874	85 3.346	90 3.543	P.92
FT-H35-M2S6	750 29.528	550 21.654	330 12.992	280 11.024	200 7.874	85 3.346	90 3.543	P.92
FT-HL80Y	3,500 137.795 (Note 3)	3,500 137.795 (Note 3)	1,800 70.866	1,350 53.150	900 35.433	450 17.717	480 18.898	P.92
FT-K8	3,000 118.110	2,000 78.740	1,500 59.055	1,000 39.370	800 31.496	300 11.811	350 13.780	P.93
FT-KV1	600 23.622	500 19.685	300 11.811	250 9.843	180 7.087	90 3.543	100 3.937	P.93
FT-KV8	3,000 118.110	2,000 78.740	1,500 59.055	1,000 39.370	800 31.496	300 11.811	350 13.780	P.93
FT-L80Y	3,500 137.795	3,500 137.795	2,000 78.740	1,500 59.055	1,000 39.370	500 19.685	530 20.866	P.93
FT-NFM2	400 15.748	270 10.630	200 7.874	140 5.512	100 3.937	55 2.165	49 1.929	P.93
FT-NFM2S	400 15.748	270 10.630	200 7.874	140 5.512	100 3.937	55 2.165	49 1.929	P.93
FT-NFM2S4	400 15.748	270 10.630	200 7.874	140 5.512	100 3.937	55 2.165	49 1.929	P.93
FT-P2	350 13.780	280 11.024	160 6.299	120 4.724	90 3.543	40 1.575	42 1.654	P.93
FT-P40	350 13.780	250 9.843	150 5.906	100 3.937	75 2.953	30 1.181	35 1.378	P.93
FT-P60	550 21.654	400 15.748	250 9.843	190 7.480	140 5.512	70 2.756	80 3.150	P.93

Notes: 1) Refer to p.35~ for the sensing ranges for the **FX-301-HS** in H-SP mode.

2) Note that the sensing range of the free-cut type fiber may be reduced by 20 % max. depending upon how the fiber is cut.

3) The fiber cable length practically limits the sensing range to 3,500 mm [137.795 in](#) long.

4) The fiber cable length practically limits the sensing range to 19,500 mm [767.717 in](#) long.

5) Heat-resistant joint fibers and ordinary-temperature fibers (**FT-FM2**) are sold as a set.

6) Sold as a set comprising vacuum type fiber + photo-terminal (**FV-BR1**) + fiber at atmospheric side (**FT-J8**).

LIST OF FIBERS

FX-301 / FX-305 (Red LED type) sensing range (Note 1)

Thru-beam type (one pair set)



The **FX-305** and **FX-301(-HS)** have different sensing modes.

FX-305: H-SP, FAST, STD, STDF, LONG, U-LG (no S-D mode)

FX-301(-HS): S-D, H-SP (Note 1), FAST, STD, LONG (no STDF or U-LG mode)

Fibers are listed in alphabetic order. Refer to p.5~ "Fiber Selection" for details of each fiber.

Model No.	Sensing range (mm in) (Note 2)							Dimensions
	Red LED							
	U-LG	LONG	STDF	STD	FAST	H-SP	S-D	
FT-P80	900 35.433	650 25.591	400 15.748	320 12.598	230 9.055	100 3.937	110 4.331	P.93
FT-P81X	900 35.433	650 25.591	380 14.961	320 12.598	230 9.055	100 3.937	110 4.331	P.94
FT-PS1	100 3.937	80 3.150	50 1.969	40 1.575	30 1.181	13 0.512	17 0.669	P.93
FT-R80	740 29.134	530 20.866	320 12.598	230 9.055	150 5.906	75 2.953	80 3.150	P.94
FT-S20	450 17.717	310 12.205	210 8.268	150 5.906	110 4.331	60 2.362	60 2.362	P.94
FT-S21	440 17.323	290 11.417	200 7.874	142 5.591	105 4.134	58 2.283	49 1.929	P.94
FT-S30	1,300 51.181	900 35.433	600 23.622	450 17.717	330 12.992	180 7.087	180 7.087	P.94
FT-SFM2	1,000 39.370	780 30.709	500 19.685	400 15.748	280 11.024	150 5.906	130 5.118	P.94
FT-SFM2L	2,000 78.740	1,600 62.992	820 32.283	800 31.496	580 22.835	170 6.693	280 11.024	P.94
FT-SFM2SV2	550 21.654	400 15.748	240 9.449	200 7.874	140 5.512	65 2.559	70 2.756	P.94
FT-SNFM2	400 15.748	270 10.630	200 7.874	140 5.512	100 3.937	55 2.165	49 1.929	P.95
FT-T80	1,000 39.370	780 30.709	500 19.685	400 15.748	280 11.024	150 5.906	130 5.118	P.95
FT-V10	2,350 92.520	2,000 78.740	1,400 55.118	1,000 39.370	800 31.496	340 13.386	350 13.780	P.95
FT-V22	410 16.142	390 15.354	220 8.661	180 7.087	125 4.921	60 2.362	63 2.480	P.95
FT-V41	220 8.661	175 6.890	100 3.937	80 3.150	60 2.362	25 0.984	27 1.063	P.95
FT-V80Y	1,000 39.370	800 31.496	500 19.685	400 15.748	280 11.024	120 4.724	140 5.512	P.95
FT-W4	220 8.661	160 6.299	100 3.937	80 3.150	55 2.165	25 0.984	28 1.102	P.95
FT-W8	750 29.528	570 22.441	350 13.780	290 11.417	200 7.874	90 3.543	100 3.937	P.95
FT-WA8	3,500 137.795 (Note 3)	3,500 137.795 (Note 3)	3,300 129.921	1,500 59.055	1,100 43.307	1,080 42.520	750 29.528	P.95
FT-WA30	3,500 137.795 (Note 3)	3,500 137.795 (Note 3)	3,500 137.795 (Note 3)	3,500 137.795 (Note 3)	3,500 137.795 (Note 3)	3,000 118.110	3,500 137.795 (Note 3)	P.95
FT-WKV8	2,200 86.614	1,700 66.929	1,000 39.370	700 27.559	600 23.622	280 11.024	300 11.811	P.96
FT-WR80	750 29.528	570 22.441	350 13.780	290 11.417	200 7.874	90 3.543	100 3.937	P.96
FT-WR80L	1,500 59.055	1,200 47.244	750 29.528	600 23.622	420 16.535	200 7.874	210 8.268	P.96
FT-WS3	780 30.709	570 22.441	340 13.386	290 11.417	200 7.874	90 3.543	100 3.937	P.96
FT-WS4	220 8.661	160 6.299	100 3.937	80 3.150	55 2.165	25 0.984	28 1.102	P.96
FT-WS8	750 29.528	570 22.441	350 13.780	290 11.417	200 7.874	90 3.543	100 3.937	P.96
FT-WS8L	1,500 59.055	1,200 47.244	750 29.528	600 23.622	420 16.535	200 7.874	210 8.268	P.96
FT-WV42	120 4.724	90 3.543	55 2.165	40 1.575	30 1.181	13 0.512	15 0.591	P.96
FT-WZ4	300 11.811	200 7.874	140 5.512	100 3.937	70 2.756	40 1.575	40 1.575	P.96
FT-WZ4HB	220 8.661	150 5.906	105 4.134	75 2.953	50 1.969	30 1.181	30 1.181	P.97
FT-WZ7	660 25.984	440 17.323	308 12.126	220 8.661	150 5.906	80 3.150	80 3.150	P.97
FT-WZ7HB	870 34.252	580 22.835	406 15.984	290 11.417	210 8.268	110 4.331	110 4.331	P.97
FT-WZ8	950 37.402	700 27.559	420 16.535	330 12.992	240 9.449	100 3.937	120 4.724	P.97
FT-WZ8E	2,100 82.677	1,500 59.055	950 37.402	700 27.559	500 19.685	200 7.874	210 8.268	P.97
FT-WZ8H	3,500 137.795	2,500 98.425	1,600 62.992	1,200 47.244	850 33.465	400 15.748	410 16.142	P.97
FT-Z8	1,100 43.307	800 31.496	500 19.685	400 15.748	300 11.811	120 4.724	140 5.512	P.97
FT-Z8E	1,850 72.835	1,600 62.992	950 37.402	800 31.496	600 23.622	250 9.843	280 11.024	P.97
FT-Z8H	3,100 122.047	2,700 106.299	1,550 61.024	1,400 55.118	1,000 39.370	420 16.535	490 19.291	P.97
FT-Z802Y	3,500 137.795	3,500 137.795	3,000 118.110	1,500 59.055	1,000 39.370	500 19.685	530 20.866	P.97

Notes: 1) Refer to p.35~ for the sensing ranges for the **FX-301(-HS)** in H-SP mode.

2) Note that the sensing range of the free-cut type fiber may be reduced by 20 % max. depending upon how the fiber is cut.

3) The fiber cable length practically limits the sensing range to 3,500 mm 137.795 in long.

FIBER SENSORS

LASER SENSORS

PHOTO-ELECTRIC SENSORS

MICRO PHOTO-ELECTRIC SENSORS

AREA SENSORS

LIGHT CURTAINS

PRESSURE / FLOW SENSORS

INDUCTIVE PROXIMITY SENSORS

PARTICULAR USE SENSORS

SENSOR OPTIONS

SIMPLE WIRE-SAVING UNITS

WIRE-SAVING SYSTEMS

MEASUREMENT SENSORS

STATIC CONTROL DEVICES

ENDOSCOPE

LASER MARKERS

PLC / TERMINALS

HUMAN MACHINE INTERFACES

ENERGY CONSUMPTION VISUALIZATION COMPONENTS

FA COMPONENTS

MACHINE VISION SYSTEMS

UV CURING SYSTEMS

Selection Guide

Fibers

Amplifiers

FX-500

FX-100

FX-300

FX-410

FX-311

FX-301-F7/

FX-301-F

FIBER SENSORS

LASER SENSORS

PHOTO-ELECTRIC SENSORS

MICRO PHOTO-ELECTRIC SENSORS

AREA SENSORS

LIGHT CURTAINS

PRESSURE / FLOW SENSORS

INDUCTIVE PROXIMITY SENSORS

PARTICULAR USE SENSORS

SENSOR OPTIONS

SMILE WIRE-SAVING UNITS

WIRE-SAVING SYSTEMS

MEASUREMENT SENSORS

STATIC CONTROL DEVICES

ENDOSCOPE

LASER MARKERS

PLC/ TERMINALS

HUMAN MACHINE INTERFACES

ENERGY CONSUMPTION VISUALIZATION COMPONENTS

FA COMPONENTS

MACHINE VISION SYSTEMS

UV CURING SYSTEMS

Selection Guide

Fibers

Amplifiers

FX-500

FX-100

FX-300

FX-410

FX-311

FX-301-F7/ FX-301-F

LIST OF FIBERS

FX-301 / FX-305 (Red LED type) sensing range (Note 1)

Retroreflective type

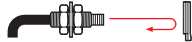

The **FX-305** and **FX-301(-HS)** have different sensing modes.
FX-305: H-SP, FAST, STD, STDF, LONG, U-LG (no S-D mode)
FX-301(-HS): S-D, H-SP (Note 1), FAST, STD, LONG (no STDF or U-LG mode)

Fibers are listed in alphabetic order. Refer to p.5~ "Fiber Selection" for details of each fiber.

Model No.	Sensing range (mm in) (Note 2, 3)							Dimensions
	Red LED							
	U-LG	LONG	STDF	STD	FAST	H-SP	S-D	
FR-KV1	15 to 370 0.591 to 14.567	15 to 330 0.591 to 12.992	15 to 240 0.591 to 9.449	15 to 210 0.591 to 8.268	15 to 170 0.591 to 6.693	15 to 80 0.591 to 3.150	15 to 90 0.591 to 3.543	P.98
FR-KZ21	20 to 200 0.787 to 7.874	20 to 200 0.787 to 7.874	20 to 200 0.787 to 7.874	20 to 200 0.787 to 7.874	20 to 200 0.787 to 7.874	20 to 200 0.787 to 7.874	20 to 200 0.787 to 7.874	P.98
FR-KZ21E	20 to 200 0.787 to 7.874	20 to 200 0.787 to 7.874	20 to 200 0.787 to 7.874	20 to 200 0.787 to 7.874	20 to 200 0.787 to 7.874	20 to 200 0.787 to 7.874	20 to 200 0.787 to 7.874	P.98
FR-WKZ11	100 to 910 3.937 to 35.827	100 to 730 3.937 to 28.740	100 to 600 3.937 to 23.622	100 to 520 3.937 to 20.472	100 to 460 3.937 to 18.110	—	—	P.98

- Notes: 1) Refer to p.35~ for the sensing ranges for the **FX-301-HS** in H-SP mode.
 2) Note that the sensing range of the free-cut type fiber may be reduced by 20 % max. depending upon how the fiber is cut.
 The sensing range of **FR-WKZ11** is specified for the **RF-13**. The sensing range of **FR-KZ21** and **FR-KZ21E** is specified for the attached reflector **RF-003**. The sensing range of **FR-KV1** is specified for the attached reflector.
 3) The sensing range of retroreflective type is the possible setting range for the attached reflector. The fiber can detect an object less than setting range for the reflector. However, note that if there are any white or highly-reflective surfaces near the fiber head, reflected incident light may affect the fiber head. If this occurs, adjust the threshold value of the amplifier unit before use.

FX-301 / FX-305 (Red LED type) sensing range (Note 1)

Reflective type



The **FX-305** and **FX-301(-HS)** have different sensing modes.
FX-305: H-SP, FAST, STD, STDF, LONG, U-LG (no S-D mode)
FX-301(-HS): S-D, H-SP (Note 1), FAST, STD, LONG (no STDF or U-LG mode)

Fibers are listed in alphabetic order. Refer to p.5~ "Fiber Selection" for details of each fiber.

Model No.	Sensing range (mm in) (Note 2, 3)							Dimensions
	Red LED							
	U-LG	LONG	STDF	STD	FAST	H-SP	S-D	
FD-30	170 6.693	110 4.331	70 2.756	50 1.969	40 1.575	20 0.787	18 0.709	P.99
FD-31	150 5.906	95 3.740	63 2.480	45 1.772	35 1.378	17 0.669	16 0.630	P.99
FD-40	170 6.693	110 4.331	70 2.756	50 1.969	40 1.575	20 0.787	18 0.709	P.99
FD-41	150 5.906	95 3.740	63 2.480	45 1.772	35 1.378	17 0.669	16 0.630	P.99
FD-60	500 19.685	350 13.780	240 9.449	160 6.299	130 5.118	70 2.756	70 2.756	P.99
FD-61	440 17.323	320 12.598	205 8.071	145 5.709	105 4.134	65 2.559	60 2.362	P.99
FD-A15	230 9.055	200 7.874	150 5.906	150 5.906	100 3.937	45 1.772	50 1.969	P.99
FD-AFM2	290 11.417	220 8.661	135 5.315	110 4.331	78 3.071	35 1.378	39 1.535	P.99
FD-AFM2E	290 11.417	220 8.661	135 5.315	110 4.331	78 3.071	35 1.378	39 1.535	P.99
FD-B8	600 23.622	480 18.898	280 11.024	220 8.661	160 6.299	85 3.346	75 2.953	P.99
FD-E12	15 0.591	11 0.433	8 0.315	6 0.236	4 0.157	2 0.079	1 0.039	P.100
FD-E22	65 2.559	45 1.772	28 1.102	23 0.906	17 0.669	8 0.315	7 0.276	P.100
FD-EG1	50 1.969	38 1.496	25 0.984	18 0.709	14 0.551	5 0.197	6 0.236	P.100
FD-EG2	40 1.575	25 0.984	14 0.551	12 0.472	9 0.354	3 0.118	5 0.197	P.100
FD-EG3	20 0.787	15 0.591	9 0.354	8 0.315	5 0.197	2.5 0.098	3 0.118	P.100
FD-EN500S1	6.5 0.256	5 0.197	3 0.118	3 0.118	2 0.079	Cannot use	Cannot use	P.100
FD-ENM1S1	50 1.969	38 1.496	20 0.787	18 0.709	14 0.551	5 0.197	6 0.236	P.100
FD-F4	Applicable pipe diameter: Outer dia. $\phi 6$ to $\phi 26$ mm $\phi 0.236$ to $\phi 1.024$ in transparent pipe [PFA (fluorine resin) or equivalently transparent pipe, wall thickness 1 mm 0.039 in]							P.100
FD-F41	Applicable pipe diameter: Outer dia. $\phi 6$ to $\phi 26$ mm $\phi 0.236$ to $\phi 1.024$ in transparent pipe [PVC (vinyl chloride), fluorine resin, polycarbonate, acrylic, glass, wall thickness 1 to 3 mm 0.039 to 0.118 in]							P.100
FD-F41Y	$\phi 4$ mm $\phi 0.157$ in form Protective tube: fluorine resin, length 500 mm 19.685 in (cuttable) Liquid surface not contacted: Beam received, Liquid surface contacted: Beam interrupted							P.101
FD-F8Y	—							P.101
FD-FA90	Applicable pipe diameter: Outer dia. $\phi 8$ mm $\phi 0.315$ in or more transparent pipe (When used with the tying bands: $\phi 8$ to $\phi 80$ mm $\phi 0.315$ to $\phi 3.150$ in) [PFA (fluorine resin), including translucent] Liquid absent: Beam received, Liquid present: Beam interrupted							P.101
FD-FM2	410 16.142	310 12.205	200 7.874	140 5.512	100 3.937	55 2.165	47 1.850	P.101
FD-FM2S	370 14.567	270 10.630	170 6.693	110 4.331	85 3.346	45 1.772	39 1.535	P.101
FD-FM2S4	370 14.567	270 10.630	170 6.693	110 4.331	85 3.346	45 1.772	39 1.535	P.101
FD-G4	150 5.906	110 4.331	65 2.559	55 2.165	42 1.654	15 0.591	19 0.748	P.101
FD-G6	150 5.906	110 4.331	65 2.559	55 2.165	42 1.654	15 0.591	19 0.748	P.102
FD-G6X	150 5.906	90 3.543	48 1.890	45 1.772	35 1.378	12 0.472	20 0.787	P.102
FD-G40	150 5.906	110 4.331	65 2.559	55 2.165	42 1.654	15 0.591	19 0.748	P.101
FD-G60	410 16.142	310 12.205	200 7.874	140 5.512	100 3.937	55 2.165	47 1.850	P.102
FD-H13-FM2	410 16.142	310 12.205	200 7.874	140 5.512	100 3.937	55 2.165	47 1.850	P.102
FD-H18-L31	0 to 20 0 to 0.787	0 to 15 0 to 0.591	0 to 10 0 to 0.394	0 to 10 0 to 0.394	1 to 8 0.039 to 0.315	Cannot use	2 to 6 0.079 to 0.236	P.102

- Notes: 1) Refer to p.35~ for the sensing ranges for the **FX-301-HS** in H-SP mode.
 2) The standard sensing objects of the sensing ranges vary depending on the fibers.
 3) Note that the sensing range of the free-cut type fiber may be reduced by 20 % max. depending upon how the fiber is cut.

SENSING RANGE OF BLUE LED / GREEN LED / INFRARED LED

Thru-beam type (One pair set)

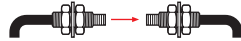

Fibers are listed in alphabetic order. Refer to p.5~ for details of each fiber.

Model No.	Sensing range (mm in) (Note 1)									Dimensions
	FX-301B			FX-301G			FX-301H (Note 2)			
	LONG	STD	FAST	LONG	STD	FAST	LONG	STD	FAST	
FT-30	55 2.165	28 1.102	18 0.709	28 1.102	13 0.512	9 0.354	25 0.984	13 0.512	9 0.354	P.90
FT-31	50 1.969	25 0.984	16 0.630	24 0.945	12 0.472	8 0.315	23 0.906	11 0.433	8 0.315	P.90
FT-40	155 6.102	76 2.992	45 1.772	90 3.543	40 1.575	26 1.024	80 3.150	43 1.693	27 1.063	P.90
FT-41	150 5.906	75 2.953	40 1.575	70 2.756	35 1.378	24 0.945	50 1.969	25 0.984	18 0.709	P.90
FT-42	150 5.906	75 2.953	40 1.575	80 3.150	35 1.378	24 0.945	75 2.953	40 1.575	25 0.984	P.90
FT-A8	600 23.622	300 11.811	220 8.661	300 11.811	150 5.906	110 4.331	220 8.661	110 4.331	80 3.150	P.90
FT-A30	2,400 94.488	1,200 47.244	700 27.559	1,200 47.244	600 23.622	350 13.780	800 31.496	400 15.748	240 9.449	P.90
FT-AFM2	120 4.724	60 2.362	40 1.575	60 2.362	30 1.181	20 0.787	48 1.890	24 0.945	18 0.709	P.90
FT-AFM2E	120 4.724	60 2.362	40 1.575	60 2.362	30 1.181	20 0.787	48 1.890	24 0.945	18 0.709	P.90
FT-B8	220 8.661	110 4.331	75 2.953	110 4.331	55 2.165	40 1.575	100 3.937	50 1.969	30 1.181	P.90
FT-E12	3 0.118	2 0.079	1 0.039	1 0.039	—	—	4 0.157	2 0.079	1.5 0.059	P.91
FT-E13	2 0.079	1 0.039	—	1 0.039	—	—	2 0.079	1 0.039	—	P.91
FT-E22	14 0.551	7 0.276	4 0.157	6 0.236	3 0.118	2 0.079	10 0.394	5 0.197	3 0.118	P.91
FT-E23	8 0.315	4 0.157	3 0.118	4 0.157	2 0.079	1 0.039	10 0.394	5 0.197	3 0.118	P.91
FT-FM2	150 5.906	75 2.953	40 1.575	70 2.756	35 1.378	24 0.945	50 1.969	25 0.984	18 0.709	P.91
FT-FM2S	150 5.906	75 2.953	40 1.575	70 2.756	35 1.378	24 0.945	50 1.969	25 0.984	18 0.709	P.91
FT-FM2S4	150 5.906	75 2.953	40 1.575	70 2.756	35 1.378	24 0.945	50 1.969	25 0.984	18 0.709	P.91
FT-FM10L	5,400 212.598	2,700 106.299	1,900 74.803	2,800 110.236	1,400 55.118	1,000 39.370	2,400 94.488 (Note 3)	1,200 47.244 (Note 3)	900 35.433 (Note 3)	P.91
FT-H13-FM2	72 2.835	36 1.417	26 1.024	32 1.260	16 0.630	10 0.394	70 2.756	35 1.378	25 0.984	P.91
FT-H20-J20-S (Note 4)	60 2.362	20 0.787	—	35 1.378	—	—	20 0.787	—	—	P.92
FT-H20-J30-S (Note 4)	60 2.362	20 0.787	—	35 1.378	—	—	20 0.787	—	—	P.92
FT-H20-J50-S (Note 4)	60 2.362	20 0.787	—	35 1.378	—	—	20 0.787	—	—	P.92
FT-H20-M1	100 3.937	50 1.969	35 1.378	50 1.969	25 0.984	18 0.709	550 21.654	280 11.024	160 6.299	P.92
FT-H20-VJ50-S (Note 4)	85 3.346	30 1.181	—	50 1.969	—	—	30 1.181	—	—	P.92
FT-H20-VJ80-S (Note 4)	85 3.346	30 1.181	—	50 1.969	—	—	30 1.181	—	—	P.92
FT-H20W-M1	44 1.732	22 0.866	14 0.551	22 0.866	11 0.433	7 0.276	220 8.661	100 3.937	70 2.756	P.92
FT-H30-M1V-S (Note 5)	40 1.575	20 0.787	—	20 0.787	—	—	20 0.787	—	—	P.92
FT-H35-M2	100 3.937	50 1.969	35 1.378	50 1.969	25 0.984	18 0.709	550 21.654	280 11.024	160 6.299	P.92
FT-H35-M2S6	100 3.937	50 1.969	35 1.378	50 1.969	25 0.984	18 0.709	550 21.654	280 11.024	160 6.299	P.92
FT-HL80Y	80 3.150	40 1.575	25 0.984	110 4.331	55 2.165	40 1.575	1,100 43.307	550 21.654	350 13.780	P.92
FT-K8	400 15.748	200 7.874	130 5.118	200 7.874	100 3.937	65 2.559	150 5.906	75 2.953	40 1.575	P.93
FT-KV1	80 3.150	35 1.378	10 0.394	—	—	—	—	—	—	P.93
FT-KV8	400 15.748	200 7.874	130 5.118	200 7.874	100 3.937	65 2.559	150 5.906	75 2.953	40 1.575	P.93
FT-L80Y	160 6.299	80 3.150	50 1.969	160 6.299	80 3.150	50 1.969	400 15.748	200 7.874	150 5.906	P.93
FT-NFM2	50 1.969	25 0.984	16 0.630	24 0.945	12 0.472	8 0.315	16 0.630	8 0.315	5 0.197	P.93
FT-NFM2S	50 1.969	25 0.984	16 0.630	24 0.945	12 0.472	8 0.315	16 0.630	8 0.315	5 0.197	P.93
FT-NFM2S4	50 1.969	25 0.984	16 0.630	24 0.945	12 0.472	8 0.315	16 0.630	8 0.315	5 0.197	P.93
FT-P2	36 1.417	18 0.709	14 0.551	20 0.787	10 0.394	8 0.315	18 0.709	9 0.354	7 0.276	P.93
FT-P40	32 1.260	13 0.512	12 0.472	18 0.709	9 0.354	7 0.276	14 0.551	7 0.276	5 0.197	P.93
FT-P60	50 1.969	25 0.984	18 0.709	26 1.024	13 0.512	8 0.315	20 0.787	10 0.394	7 0.276	P.93

Notes: 1) Note that the sensing range of the free-cut type fiber may be reduced by 20 % max. depending upon how the fiber is cut.

2) Because infrared types are easily affected by humidity, please ask assistance when using them in a humid environment or in an environment with varying humidity.

3) Sensing range when fiber length is 2 m 6.562 ft. When fiber length is 10 m 32.81 ft, the beam attenuates and cannot be used.

4) Heat-resistant joint fibers and ordinary-temperature fibers (FT-FM2) are sold as a set.

5) Sold as a set comprising vacuum type fiber + photo-terminal (FV-BR1) + fiber at atmospheric side (FT-J8).

SENSING RANGE OF BLUE LED / GREEN LED / INFRARED LED

Thru-beam type (One pair set) 

Fibers are listed in alphabetic order. Refer to p.5~ "Fiber Selection" for details of each fiber.

Model No.	Sensing range (mm in) (Note 1)									Dimensions
	FX-301B			FX-301G			FX-301H (Note 2)			
	LONG	STD	FAST	LONG	STD	FAST	LONG	STD	FAST	
FT-P80	130 5.118	65 2.559	45 1.772	70 2.756	35 1.378	25 0.984	56 2.205	28 1.102	20 0.787	P.93
FT-P81X	130 5.118	64 2.520	45 1.772	64 2.520	32 1.260	25 0.984	56 2.205	28 1.102	20 0.787	P.94
FT-PS1	14 0.551	7 0.276	4 0.157	6 0.236	3 0.118	2 0.079	14 0.551	7 0.276	4 0.157	P.93
FT-R80	85 3.346	42 1.654	28 1.102	44 1.732	22 0.866	16 0.630	32 1.260	16 0.630	12 0.472	P.94
FT-S20	55 2.165	28 1.102	18 0.709	28 1.102	13 0.512	9 0.354	25 0.984	13 0.512	9 0.354	P.94
FT-S21	50 1.969	25 0.984	16 0.630	24 0.945	12 0.472	8 0.315	23 0.906	11 0.433	8 0.315	P.94
FT-S30	155 6.102	76 2.992	45 1.772	90 3.543	40 1.575	26 1.024	80 3.150	43 1.693	27 1.063	P.94
FT-SFM2	150 5.906	75 2.953	40 1.575	70 2.756	35 1.378	24 0.945	50 1.969	25 0.984	18 0.709	P.94
FT-SFM2L	400 15.748	200 7.874	130 5.118	200 7.874	100 3.937	65 2.559	155 6.102	77 3.031	55 2.165	P.94
FT-SFM2SV2	80 3.150	40 1.575	28 1.102	40 1.575	20 0.787	14 0.551	30 1.181	15 0.591	12 0.472	P.94
FT-SNFM2	50 1.969	25 0.984	16 0.630	24 0.945	12 0.472	8 0.315	16 0.630	8 0.315	5 0.197	P.95
FT-T80	150 5.906	75 2.953	40 1.575	70 2.756	35 1.378	24 0.945	50 1.969	25 0.984	18 0.709	P.95
FT-V10	400 15.748	200 7.874	130 5.118	200 7.874	100 3.937	65 2.559	150 5.906	75 2.953	40 1.575	P.95
FT-V22	50 1.969	25 0.984	16 0.630	26 1.024	13 0.512	8 0.315	44 1.732	22 0.866	15 0.591	P.95
FT-V41	28 1.102	14 0.551	10 0.394	14 0.551	7 0.276	5 0.197	10 0.394	5 0.197	3 0.118	P.95
FT-V80Y	120 4.724	60 2.362	35 1.378	80 3.150	40 1.575	25 0.984	75 2.953	38 1.496	24 0.945	P.95
FT-W4	16 0.630	8 0.315	5 0.197	10 0.394	5 0.197	3 0.118	8 0.315	4 0.157	2.5 0.098	P.95
FT-W8	90 3.543	45 1.772	30 1.181	56 2.205	28 1.102	20 0.787	42 1.654	21 0.827	15 0.591	P.95
FT-WA8	600 23.622	300 11.811	220 8.661	300 11.811	150 5.906	110 4.331	220 8.661	110 4.331	80 3.150	P.95
FT-WA30	2,400 94.488	1,200 47.244	700 27.560	1,200 47.244	600 23.622	350 13.780	800 31.496	400 15.748	240 9.449	P.95
FT-WKV8	300 11.811	150 5.906	100 3.937	160 6.299	80 3.150	60 2.362	150 5.906	75 2.953	45 1.772	P.96
FT-WR80	90 3.543	45 1.772	30 1.181	56 2.205	28 1.102	20 0.787	48 1.890	22 0.866	14 0.551	P.96
FT-WR80L	240 9.449	120 4.724	90 3.543	120 4.724	60 2.362	40 1.575	132 5.197	65 2.559	42 1.654	P.96
FT-WS3	90 3.543	45 1.772	30 1.181	56 2.205	28 1.102	20 0.787	————	————	————	P.96
FT-WS4	16 0.630	8 0.315	5 0.197	10 0.394	5 0.197	3 0.118	8 0.315	4 0.157	2.5 0.098	P.96
FT-WS8	90 3.543	45 1.772	30 1.181	56 2.205	28 1.102	20 0.787	42 1.654	21 0.827	15 0.591	P.96
FT-WS8L	240 9.449	120 4.724	90 3.543	120 4.724	60 2.362	40 1.575	110 4.331	55 2.165	35 1.378	P.96
FT-WV42	————	————	————	————	————	————	————	————	————	P.96
FT-WZ4	35 1.378	15 0.591	9 0.354	18 0.709	8 0.315	4.8 0.189	43 1.693	15 0.591	9 0.354	P.96
FT-WZ4HB	32 1.260	15 0.591	9.6 0.378	16 0.630	9 0.354	5.4 0.213	40 1.575	15 0.591	12 0.472	P.97
FT-WZ7	80 3.150	40 1.575	24 0.945	54 2.216	27 1.063	16.2 0.638	54 2.126	27 1.063	16.2 0.638	P.97
FT-WZ7HB	100 3.937	50 1.969	30 1.181	56 2.205	28 1.102	16.8 0.661	56 2.205	28 1.102	16.8 0.661	P.97
FT-WZ8	80 3.150	40 1.575	25 0.984	40 1.575	20 0.787	13 0.512	36 1.417	18 0.709	12 0.472	P.97
FT-WZ8E	240 9.449	120 4.724	80 3.150	120 4.724	60 2.362	40 1.575	100 3.937	50 1.969	30 1.181	P.97
FT-WZ8H	400 15.748	200 7.874	140 5.512	200 7.874	100 3.937	70 2.756	180 7.087	90 3.543	65 2.559	P.97
FT-Z8	120 4.724	60 2.362	40 1.575	60 2.362	30 1.181	22 0.866	46 1.811	23 0.906	16 0.630	P.97
FT-Z8E	400 15.748	200 7.874	140 5.512	200 7.874	100 3.937	65 2.559	140 5.512	70 2.756	50 1.969	P.97
FT-Z8H	560 22.047	280 11.024	200 7.874	200 7.874	100 3.937	65 2.559	180 7.087	90 3.543	65 2.559	P.97
FT-Z802Y	320 12.598	160 6.299	120 4.724	160 6.299	80 3.150	60 2.362	320 12.598	160 6.299	120 4.724	P.97

Notes: 1) Note that the sensing range of the free-cut type fiber may be reduced by 20 % max. depending upon how the fiber is cut.
 2) Because infrared types are easily affected by humidity, please ask assistance when using them in a humid environment or in an environment with varying humidity.

FIBER SENSORS

LASER SENSORS

PHOTO-ELECTRIC SENSORS

MICRO PHOTO-ELECTRIC SENSORS

AREA SENSORS

LIGHT CURTAINS

PRESSURE / FLOW SENSORS

INDUCTIVE PROXIMITY SENSORS

PARTICULAR USE SENSORS

SENSOR OPTIONS

SIMPLE WIRE-SAVING UNITS

WIRE-SAVING SYSTEMS

MEASUREMENT SENSORS

STATIC CONTROL DEVICES

ENDOSCOPE

LASER MARKERS

PLC / TERMINALS

HUMAN MACHINE INTERFACES

ENERGY CONSUMPTION VISUALIZATION COMPONENTS

FA COMPONENTS

MACHINE VISION SYSTEMS

UV CURING SYSTEMS

Selection Guide

Fibers

Amplifiers

FX-500

FX-100

FX-300

FX-410

FX-311

FX-301-F7/ FX-301-F

SENSING RANGE OF BLUE LED / GREEN LED / INFRARED LED

Retroreflective type 

Fibers are listed in alphabetic order. Refer to p.5~ "Fiber Selection" for details of each fiber.

Model No.	Sensing range (mm in) (Note 1, 2)									Dimensions
	FX-301B			FX-301G			FX-301H			
	LONG	STD	FAST	LONG	STD	FAST	LONG	STD	FAST	
FR-KV1	—	—	—	—	—	—	—	—	—	P.98
FR-KZ21	20 to 200 0.787 to 7.874	20 to 120 0.787 to 4.724	20 to 90 0.787 to 3.543	20 to 130 0.787 to 5.118	20 to 80 0.787 to 3.150	20 to 50 0.787 to 1.969	20 to 130 0.787 to 5.118	20 to 70 0.787 to 2.756	—	P.98
FR-KZ21E	20 to 160 0.787 to 6.299	20 to 100 0.787 to 3.937	20 to 60 0.787 to 2.362	20 to 110 0.787 to 4.331	—	—	20 to 90 0.787 to 3.543	—	—	P.98
FR-WKZ11	—	—	—	—	—	—	100 to 340 3.937 to 13.386	—	—	P.98

Notes: 1) Note that the sensing range of the free-cut type fiber may be reduced by 20 % max. depending upon how the fiber is cut.
 2) The sensing range of retroreflective type is the possible setting range for the attached reflector. The fiber can detect an object less than setting range for the reflector. However, note that if there are any white or highly-reflective surfaces near the fiber head, reflected incident light may affect the fiber head. If this occurs, adjust the threshold value of the amplifier unit before use.

Reflective type 

Fibers are listed in alphabetic order. Refer to p.5~ "Fiber Selection" for details of each fiber.

Model No.	Sensing range (mm in) (Note 1, 2)									Dimensions
	FX-301B			FX-301G			FX-301H			
	LONG	STD	FAST	LONG	STD	FAST	LONG	STD	FAST	
FD-30	19 0.748	9 0.354	6 0.236	9 0.354	4.5 0.177	2.5 0.098	8 0.315	4 0.157	2.5 0.098	P.99
FD-31	18 0.709	8 0.315	5 0.197	8 0.315	4 0.157	2 0.079	7 0.276	3 0.118	2 0.079	P.99
FD-40	19 0.748	9 0.354	6 0.236	9 0.354	4.5 0.177	2.5 0.098	8 0.315	4 0.157	2.5 0.098	P.99
FD-41	18 0.709	8 0.315	5 0.197	8 0.315	4 0.157	2 0.079	7 0.276	3 0.118	2 0.079	P.99
FD-60	55 2.165	28 1.102	18 0.709	30 1.181	15 0.591	10 0.394	30 1.181	15 0.591	10 0.394	P.99
FD-61	48 1.890	24 0.945	16 0.630	26 1.024	13 0.512	8 0.315	27 1.063	12 0.472	8 0.315	P.99
FD-A15	25 0.984	15 0.591	—	—	—	—	—	—	—	P.99
FD-AFM2	40 1.575	20 0.787	13 0.512	18 0.709	9 0.354	5 0.197	12 0.472	6 0.236	4 0.157	P.99
FD-AFM2E	40 1.575	20 0.787	13 0.512	18 0.709	9 0.354	5 0.197	12 0.472	6 0.236	4 0.157	P.99
FD-B8	80 3.150	40 1.575	26 1.024	42 1.654	21 0.827	14 0.551	26 1.024	13 0.512	9 0.354	P.99
FD-E12	2 0.079	1 0.039	—	1 0.039	—	—	1 0.039	—	—	P.100
FD-E22	6 0.236	3 0.118	2 0.079	3 0.118	1.5 0.059	1 0.039	6 0.236	3 0.118	2 0.079	P.100
FD-EG1	6 0.236	3 0.118	2 0.079	3 0.118	1.5 0.059	1 0.039	10 0.394	5 0.197	3 0.118	P.100
FD-EG2	5 0.197	2 0.079	1 0.039	2 0.079	1 0.039	—	6 0.236	3 0.118	2 0.079	P.100
FD-EG3	2 0.079	1 0.039	—	1 0.039	—	—	3 0.118	1.5 0.059	1 0.039	P.100
FD-EN500S1	—	—	—	—	—	—	—	—	—	P.100
FD-ENM1S1	6 0.236	3 0.118	2 0.079	3 0.118	1.5 0.059	1 0.039	4 0.157	2 0.079	1.5 0.059	P.100
FD-F4	Applicable pipe diameter: Outer dia. ø6 to ø26 mm ø0.236 to ø1.024 in transparent pipe [PFA (fluorine resin) or equivalently transparent pipe, wall thickness 1 mm 0.039 in]									P.100
FD-F41	Applicable pipe diameter: Outer dia. ø6 to ø26 mm ø0.236 to ø1.024 in transparent pipe [PVC (vinyl chloride), fluorine resin, polycarbonate, acrylic, glass, wall thickness 1 to 3 mm 0.039 to 0.118 in]									P.100
FD-F41Y	ø4 mm ø0.157 in form Protective tube: fluorine resin, length 500 mm 19.685 in (cuttable) Liquid surface not contacted: Beam received, Liquid surface contacted: Beam interrupted									P.101
FD-F8Y	—	—	—	—	—	—	—	—	—	P.101
FD-FA90	Applicable pipe diameter: Outer dia. ø8 mm ø0.315 in or more transparent pipe (When used with the tying bands: ø8 to ø80 mm ø0.315 to ø3.150 in) [PFA (fluorine resin), including translucent] Liquid absent: Beam received, Liquid present: Beam interrupted									P.101
FD-FM2	46 1.811	23 0.906	15 0.591	24 0.945	12 0.472	8 0.315	20 0.787	10 0.394	7 0.276	P.101
FD-FM2S	46 1.811	23 0.906	15 0.591	24 0.945	12 0.472	8 0.315	20 0.787	10 0.394	7 0.276	P.101
FD-FM2S4	46 1.811	23 0.906	15 0.591	24 0.945	12 0.472	8 0.315	20 0.787	10 0.394	7 0.276	P.101
FD-G4	22 0.866	11 0.433	8 0.315	12 0.472	6 0.236	4 0.157	7 0.276	3.5 0.138	2 0.079	P.101
FD-G6	22 0.866	11 0.433	8 0.315	12 0.472	6 0.236	4 0.157	7 0.276	3.5 0.138	2 0.079	P.102
FD-G6X	33 1.299	11 0.433	6 0.236	12 0.472	6 0.236	4 0.157	7 0.276	3.5 0.138	2 0.079	P.102
FD-G40	22 0.866	11 0.433	8 0.315	12 0.472	6 0.236	4 0.157	7 0.276	3.5 0.138	2 0.079	P.101
FD-G60	46 1.811	23 0.906	15 0.591	24 0.945	12 0.472	8 0.315	20 0.787	10 0.394	7 0.276	P.102
FD-H13-FM2	20 0.787	11 0.433	7 0.276	20 0.787	11 0.433	7 0.276	25 0.984	12 0.472	8 0.315	P.102
FD-H18-L31	—	—	—	—	—	—	—	—	—	P.102
FD-H20-21	36 1.417	18 0.709	12 0.472	20 0.787	10 0.394	7 0.276	140 5.512	70 2.756	45 1.772	P.102
FD-H20-M1	36 1.417	18 0.709	12 0.472	20 0.787	10 0.394	7 0.276	140 5.512	70 2.756	45 1.772	P.102

Notes: 1) The standard sensing objects of the sensing ranges vary depending on the fibers.
 2) Note that the sensing range of the free-cut type fiber may be reduced by 20 % max. depending upon how the fiber is cut.

- FIBER SENSORS
- LASER SENSORS
- PHOTO-ELECTRIC SENSORS
- MICRO PHOTO-ELECTRIC SENSORS
- AREA SENSORS
- LIGHT CURTAINS
- PRESSURE / FLOW SENSORS
- INDUCTIVE PROXIMITY SENSORS
- PARTICULAR USE SENSORS
- SENSOR OPTIONS
- SIMPLE WIRE-SAVING UNITS
- WIRE-SAVING SYSTEMS
- MEASUREMENT SENSORS
- STATIC CONTROL DEVICES
- ENDOSCOPE
- LASER MARKERS
- PLC / TERMINALS
- HUMAN MACHINE INTERFACES
- ENERGY CONSUMPTION VISUALIZATION COMPONENTS
- FA COMPONENTS
- MACHINE VISION SYSTEMS
- UV CURING SYSTEMS
- Selection Guide
- Fibers
- Amplifiers
- FX-500
- FX-100
- FX-300
- FX-410
- FX-311
- FX-301-F7/ FX-301-F

SENSING RANGE OF BLUE LED / GREEN LED / INFRARED LED

Reflective type 

Fibers are listed in alphabetic order. Refer to p.5~ "Fiber Selection" for details of each fiber.

Model No.	Sensing range (mm in) (Note 1, 2)									Dimensions
	FX-301B			FX-301G			FX-301H			
	LONG	STD	FAST	LONG	STD	FAST	LONG	STD	FAST	
FD-H25-L43	—	—	—	—	—	—	—	—	—	P.103
FD-H25-L45	—	—	—	—	—	—	—	—	—	P.103
FD-H30-KZ1V-S (Note 3)	30 to 40 1.181 to 1.575	—	—	—	—	—	—	—	—	P.103
FD-H30-L32	—	—	—	—	—	—	—	—	—	P.103
FD-H30-L32V-S (Note 3)	—	—	—	—	—	—	—	—	—	P.103
FD-H35-20S	22 0.866	11 0.433	7 0.276	12 0.472	6 0.236	4 0.157	80 3.150	40 1.575	28 1.102	P.104
FD-H35-M2	36 1.417	18 0.709	12 0.472	20 0.787	10 0.394	7 0.276	140 5.512	70 2.756	45 1.772	P.104
FD-H35-M2S6	36 1.417	18 0.709	12 0.472	20 0.787	10 0.394	7 0.276	140 5.512	70 2.756	45 1.772	P.104
FD-HF40Y	ø4 mm ø0.157 in form Protective tube: fluorine resin, length:500 mm 19.685 in (allowable cutting) Liquid surface not contacted: Beam received, Liquid surface contacted: Beam interrupted									P.104
FD-L4	4.5 to 9.5 0.177 to 0.374 (Convergent point 6 0.236)	5 to 9 0.197 to 0.354 (Convergent point 6 0.236)	5.5 to 8 0.217 to 0.315 (Convergent point 6 0.236)	5 to 9 0.197 to 0.354 (Convergent point 6 0.236)	5.5 to 8 0.217 to 0.315 (Convergent point 6 0.236)	—	4.5 to 9.5 0.177 to 0.374 (Convergent point 6 0.236)	—	—	P.104
FD-L41	—	—	—	—	—	—	—	—	—	P.104
FD-L43	—	—	—	—	—	—	—	—	—	P.104
FD-L44	0 to 5.7 0 to 0.224	1 to 4.5 0.039 to 0.177	1.5 to 3.8 0.059 to 0.150	1 to 4.6 0.039 to 0.181	2.5 to 3 0.098 to 0.118	—	1 to 4.3 0.039 to 0.169	—	—	P.104
FD-L44S	0 to 3.5 0 to 0.138	1 to 3 0.039 to 0.118	—	1 to 3 0.039 to 0.118	—	—	1 to 4.3 0.039 to 0.169	—	—	P.104
FD-L45	—	—	—	—	—	—	—	—	—	P.104
FD-L45A	—	—	—	—	—	—	—	—	—	P.105
FD-L46	—	—	—	—	—	—	—	—	—	P.105
FD-L47	—	—	—	—	—	—	—	—	—	P.105
FD-NFM2	16 0.630	8 0.315	5 0.197	8 0.315	4 0.157	2 0.079	6 0.236	3 0.118	2 0.079	P.105
FD-NFM2S	16 0.630	8 0.315	5 0.197	8 0.315	4 0.157	2 0.079	6 0.236	3 0.118	2 0.079	P.105
FD-NFM2S4	16 0.630	8 0.315	5 0.197	8 0.315	4 0.157	2 0.079	6 0.236	3 0.118	2 0.079	P.105
FD-P2	8 0.315	4 0.157	2.5 0.098	4 0.157	2 0.079	1.5 0.059	7 0.276	3.5 0.138	2 0.079	P.105
FD-P40	5 0.197	2.5 0.098	1.5 0.059	3 0.118	1.5 0.059	1 0.039	2 0.079	1 0.039	—	P.105
FD-P50	20 0.787	10 0.394	6 0.236	10 0.394	5 0.197	3 0.118	8 0.315	4 0.157	2.5 0.098	P.105
FD-P60	20 0.787	10 0.394	6 0.236	10 0.394	5 0.197	3 0.118	8 0.315	4 0.157	2.5 0.098	P.105
FD-P80	40 1.575	20 0.787	13 0.512	20 0.787	10 0.394	7 0.276	18 0.709	9 0.354	6 0.236	P.105
FD-P81X	32 1.260	16 0.630	10 0.394	16 0.630	8 0.315	5 0.197	18 0.709	9 0.354	6 0.236	P.106
FD-R80	32 1.260	16 0.630	10 0.394	16 0.630	8 0.315	5 0.197	10 0.394	5 0.197	3 0.118	P.106
FD-S30	19 0.749	9 0.354	6 0.236	9 0.354	4.5 0.177	2.5 0.098	8 0.315	4 0.157	2.5 0.098	P.106
FD-S31	18 0.709	8 0.315	5 0.197	8 0.315	4 0.157	2 0.079	7 0.276	3 0.118	2 0.079	P.106
FD-S80	46 1.811	23 0.906	15 0.591	24 0.945	12 0.472	8 0.315	20 0.787	10 0.394	7 0.276	P.106
FD-SFM2SV2	14 0.551	7 0.276	4 0.157	7 0.276	3.5 0.138	—	4 0.157	—	—	P.106
FD-SNFM2	16 0.630	8 0.315	5 0.197	8 0.315	4 0.157	2 0.079	6 0.236	3 0.118	2 0.079	P.106
FD-T40	16 0.630	8 0.315	5 0.197	8 0.315	4 0.157	2 0.079	6 0.236	3 0.118	2 0.079	P.106
FD-T80	46 1.811	23 0.906	15 0.591	24 0.945	12 0.472	8 0.315	20 0.787	10 0.394	7 0.276	P.106
FD-V41	6 0.236	3 0.118	—	3 0.118	—	—	—	—	—	P.106
FD-W8	23 0.906	11 0.433	8 0.315	14 0.551	7 0.276	4 0.157	11 0.433	5.5 0.217	3 0.118	P.107
FD-W44	5 0.197	2.5 0.098	1.5 0.059	3 0.118	1.5 0.059	1 0.039	2 0.079	1 0.039	—	P.107
FD-WG4	11 0.433	5 0.197	3 0.118	6 0.236	3 0.118	2 0.079	5 0.197	2.5 0.098	1.5 0.059	P.107
FD-WKZ1	—	—	—	—	—	—	—	—	—	P.107
FD-WL41	—	—	—	—	—	—	—	—	—	P.107
FD-WL48	—	—	—	—	—	—	0.5 to 3.5 0.020 to 0.138	—	—	P.107
FD-WS8	23 0.906	11 0.433	8 0.315	14 0.551	7 0.276	4 0.157	11 0.433	5.5 0.217	3 0.118	P.107
FD-WSG4	11 0.433	5 0.197	3 0.118	6 0.236	3 0.118	2 0.079	5 0.197	2.5 0.098	1.5 0.059	P.107
FD-WT4	5 0.197	2.5 0.098	1.5 0.059	3 0.118	1.5 0.059	1 0.039	2 0.079	1 0.039	—	P.107
FD-WT8	23 0.906	11 0.433	8 0.315	14 0.551	7 0.276	4 0.157	11 0.433	5.5 0.217	3 0.118	P.107
FD-WV42	—	—	—	—	—	—	—	—	—	P.108
FD-WZ4	—	—	—	—	—	—	5 to 8 0.197 to 0.315	—	—	P.108
FD-WZ4HB	4 to 9 0.157 to 0.354	—	—	—	—	—	4 to 12 0.157 to 0.472	—	—	P.108
FD-WZ7	4 to 15 0.157 to 0.591	—	—	—	—	—	5 to 8 0.197 to 0.315	—	—	P.108
FD-WZ7HB	3 to 28 0.118 to 1.102	3 to 14 0.118 to 0.551	4 to 8.4 0.157 to 0.331	3 to 16 0.118 to 0.630	4 to 8 0.157 to 0.315	4.8 0.189	3 to 18 0.118 to 0.709	—	—	P.108

Notes: 1) The standard sensing objects of the sensing ranges vary depending on the fibers.
 2) Note that the sensing range of the free-cut type fiber may be reduced by 20 % max. depending upon how the fiber is cut.
 3) Sold as a set comprising vacuum type fiber + photo-terminal (FV-BR1) + fiber at atmospheric side (FT-J8).

FIBER SENSORS

LASER SENSORS

PHOTO-ELECTRIC SENSORS

MICRO PHOTO-ELECTRIC SENSORS

AREA SENSORS

LIGHT CURTAINS

PRESSURE / FLOW SENSORS

INDUCTIVE PROXIMITY SENSORS

PARTICULAR USE SENSORS

SENSOR OPTIONS

SMILE WIRE-SAVING UNITS

WIRE-SAVING SYSTEMS

MEASUREMENT SENSORS

STATIC CONTROL DEVICES

ENDOSCOPE

LASER MARKERS

PLC / TERMINALS

HUMAN MACHINE INTERFACES

ENERGY CONSUMPTION VISUALIZATION COMPONENTS

FA COMPONENTS

MACHINE VISION SYSTEMS

UV CURING SYSTEMS

Selection Guide

Fibers

Amplifiers

FX-500

FX-100

FX-300



FX-410

FX-311

FX-301-F7/ FX-301-F

FIBER OPTIONS

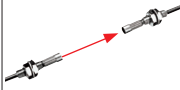
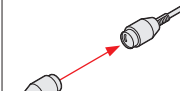
Lens (for thru-beam type fiber)

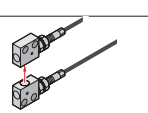
Designation	Model No.	Description																																																																																																	
For thru-beam type fiber	Expansion lens (Note 1)	<p>FX-LE1</p>  <p>Increases the sensing range by 5 times or more.</p> <ul style="list-style-type: none"> Ambient temperature: -60 to $+350$ °C -76 to $+662$ °F (Note 5) 	<p>Sensing range for red LED type (mm) [Lens on both sides] (Note 3)</p> <table border="1"> <thead> <tr> <th>Fiber \ Mode</th> <th>U-LG</th> <th>LONG</th> <th>STDF</th> <th>STD</th> <th>FAST</th> <th>S-D</th> <th>H-SP</th> </tr> </thead> <tbody> <tr><td>FT-B8</td><td>3,500 (Note 2)</td><td>3,500 (Note 2)</td><td>3,000</td><td>2,500</td><td>2,000</td><td>1,000</td><td>1,000</td></tr> <tr><td>FT-FM2</td><td>3,500 (Note 2)</td><td>3,500 (Note 2)</td><td>3,500 (Note 2)</td><td>3,500 (Note 2)</td><td>2,500</td><td>1,300</td><td>1,000</td></tr> <tr><td>FT-T80</td><td>3,500 (Note 2)</td><td>3,500 (Note 2)</td><td>3,500 (Note 2)</td><td>3,500 (Note 2)</td><td>2,500</td><td>1,300</td><td>1,000</td></tr> <tr><td>FT-R80</td><td>3,500 (Note 2)</td><td>3,500 (Note 2)</td><td>3,500 (Note 2)</td><td>2,300</td><td>1,600</td><td>800</td><td>750</td></tr> <tr><td>FT-W8</td><td>3,500 (Note 2)</td><td>3,500 (Note 2)</td><td>3,500 (Note 2)</td><td>2,900</td><td>2,000</td><td>1,000</td><td>900</td></tr> <tr><td>FT-P80</td><td>3,500 (Note 2)</td><td>3,500 (Note 2)</td><td>3,500 (Note 2)</td><td>3,500 (Note 2)</td><td>2,500</td><td>1,100</td><td>1,000</td></tr> <tr><td>FT-P60</td><td>3,500 (Note 2)</td><td>3,500 (Note 2)</td><td>3,500 (Note 2)</td><td>3,500 (Note 2)</td><td>1,500</td><td>900</td><td>800</td></tr> <tr><td>FT-P81X</td><td>1,600 (Note 2)</td><td>1,600 (Note 2)</td><td>1,600 (Note 2)</td><td>1,600 (Note 2)</td><td>1,600 (Note 2)</td><td>1,100</td><td>950</td></tr> <tr><td>FT-H35-M2</td><td>3,500 (Note 2)</td><td>3,500 (Note 2)</td><td>2,500</td><td>2,000</td><td>1,500</td><td>750</td><td>700</td></tr> <tr><td>FT-H20W-M1</td><td>1,600 (Note 2)</td><td>1,600 (Note 2)</td><td>1,600 (Note 2)</td><td>1,300</td><td>900</td><td>500</td><td>400</td></tr> <tr><td>FT-H20-M1</td><td>1,600 (Note 2)</td><td>1,600 (Note 2)</td><td>1,600 (Note 2)</td><td>1,600 (Note 2)</td><td>1,100</td><td>900</td><td>600</td></tr> </tbody> </table>	Fiber \ Mode	U-LG	LONG	STDF	STD	FAST	S-D	H-SP	FT-B8	3,500 (Note 2)	3,500 (Note 2)	3,000	2,500	2,000	1,000	1,000	FT-FM2	3,500 (Note 2)	3,500 (Note 2)	3,500 (Note 2)	3,500 (Note 2)	2,500	1,300	1,000	FT-T80	3,500 (Note 2)	3,500 (Note 2)	3,500 (Note 2)	3,500 (Note 2)	2,500	1,300	1,000	FT-R80	3,500 (Note 2)	3,500 (Note 2)	3,500 (Note 2)	2,300	1,600	800	750	FT-W8	3,500 (Note 2)	3,500 (Note 2)	3,500 (Note 2)	2,900	2,000	1,000	900	FT-P80	3,500 (Note 2)	3,500 (Note 2)	3,500 (Note 2)	3,500 (Note 2)	2,500	1,100	1,000	FT-P60	3,500 (Note 2)	3,500 (Note 2)	3,500 (Note 2)	3,500 (Note 2)	1,500	900	800	FT-P81X	1,600 (Note 2)	1,600 (Note 2)	1,600 (Note 2)	1,600 (Note 2)	1,600 (Note 2)	1,100	950	FT-H35-M2	3,500 (Note 2)	3,500 (Note 2)	2,500	2,000	1,500	750	700	FT-H20W-M1	1,600 (Note 2)	1,600 (Note 2)	1,600 (Note 2)	1,300	900	500	400	FT-H20-M1	1,600 (Note 2)	1,600 (Note 2)	1,600 (Note 2)	1,600 (Note 2)	1,100	900	600
	Fiber \ Mode	U-LG	LONG	STDF	STD	FAST	S-D	H-SP																																																																																											
	FT-B8	3,500 (Note 2)	3,500 (Note 2)	3,000	2,500	2,000	1,000	1,000																																																																																											
	FT-FM2	3,500 (Note 2)	3,500 (Note 2)	3,500 (Note 2)	3,500 (Note 2)	2,500	1,300	1,000																																																																																											
FT-T80	3,500 (Note 2)	3,500 (Note 2)	3,500 (Note 2)	3,500 (Note 2)	2,500	1,300	1,000																																																																																												
FT-R80	3,500 (Note 2)	3,500 (Note 2)	3,500 (Note 2)	2,300	1,600	800	750																																																																																												
FT-W8	3,500 (Note 2)	3,500 (Note 2)	3,500 (Note 2)	2,900	2,000	1,000	900																																																																																												
FT-P80	3,500 (Note 2)	3,500 (Note 2)	3,500 (Note 2)	3,500 (Note 2)	2,500	1,100	1,000																																																																																												
FT-P60	3,500 (Note 2)	3,500 (Note 2)	3,500 (Note 2)	3,500 (Note 2)	1,500	900	800																																																																																												
FT-P81X	1,600 (Note 2)	1,600 (Note 2)	1,600 (Note 2)	1,600 (Note 2)	1,600 (Note 2)	1,100	950																																																																																												
FT-H35-M2	3,500 (Note 2)	3,500 (Note 2)	2,500	2,000	1,500	750	700																																																																																												
FT-H20W-M1	1,600 (Note 2)	1,600 (Note 2)	1,600 (Note 2)	1,300	900	500	400																																																																																												
FT-H20-M1	1,600 (Note 2)	1,600 (Note 2)	1,600 (Note 2)	1,600 (Note 2)	1,100	900	600																																																																																												
Super-expansion lens (Note 1)	<p>FX-LE2</p>  <p>Tremendously increases the sensing range with large diameter lenses.</p> <ul style="list-style-type: none"> Ambient temperature: -60 to $+350$ °C -76 to $+662$ °F (Note 5) 	<p>Sensing range for red LED type (mm) [Lens on both sides] (Note 3)</p> <table border="1"> <thead> <tr> <th>Fiber \ Mode</th> <th>U-LG</th> <th>LONG</th> <th>STDF</th> <th>STD</th> <th>FAST</th> <th>S-D</th> <th>H-SP</th> </tr> </thead> <tbody> <tr><td>FT-B8</td><td>3,500 (Note 2)</td><td>3,500 (Note 2)</td><td>3,500 (Note 2)</td><td>3,500 (Note 2)</td><td>3,500 (Note 2)</td><td>3,500 (Note 2)</td><td>3,500 (Note 2)</td></tr> <tr><td>FT-FM2</td><td>3,500 (Note 2)</td><td>3,500 (Note 2)</td><td>3,500 (Note 2)</td><td>3,500 (Note 2)</td><td>3,500 (Note 2)</td><td>3,500 (Note 2)</td><td>3,500 (Note 2)</td></tr> <tr><td>FT-R80</td><td>3,500 (Note 2)</td><td>3,500 (Note 2)</td><td>3,500 (Note 2)</td><td>3,500 (Note 2)</td><td>3,500 (Note 2)</td><td>3,500 (Note 2)</td><td>3,500 (Note 2)</td></tr> <tr><td>FT-W8</td><td>3,500 (Note 2)</td><td>3,500 (Note 2)</td><td>3,500 (Note 2)</td><td>3,500 (Note 2)</td><td>3,500 (Note 2)</td><td>3,500 (Note 2)</td><td>3,500 (Note 2)</td></tr> <tr><td>FT-P80</td><td>3,500 (Note 2)</td><td>3,500 (Note 2)</td><td>3,500 (Note 2)</td><td>3,500 (Note 2)</td><td>3,500 (Note 2)</td><td>3,500 (Note 2)</td><td>3,500 (Note 2)</td></tr> <tr><td>FT-P60</td><td>3,500 (Note 2)</td><td>3,500 (Note 2)</td><td>3,500 (Note 2)</td><td>3,500 (Note 2)</td><td>3,500 (Note 2)</td><td>3,500 (Note 2)</td><td>3,500 (Note 2)</td></tr> <tr><td>FT-P81X</td><td>1,600 (Note 2)</td><td>1,600 (Note 2)</td><td>1,600 (Note 2)</td><td>1,600 (Note 2)</td><td>1,600 (Note 2)</td><td>1,600 (Note 2)</td><td>1,600 (Note 2)</td></tr> <tr><td>FT-H35-M2</td><td>3,500 (Note 2)</td><td>3,500 (Note 2)</td><td>3,500 (Note 2)</td><td>3,500 (Note 2)</td><td>3,500 (Note 2)</td><td>3,500 (Note 2)</td><td>3,500 (Note 2)</td></tr> <tr><td>FT-H20W-M1</td><td>1,600 (Note 2)</td><td>1,600 (Note 2)</td><td>1,600 (Note 2)</td><td>1,600 (Note 2)</td><td>1,600 (Note 2)</td><td>1,500</td><td>1,600 (Note 2)</td></tr> <tr><td>FT-H20-M1</td><td>1,600 (Note 2)</td><td>1,600 (Note 2)</td><td>1,600 (Note 2)</td><td>1,600 (Note 2)</td><td>1,600 (Note 2)</td><td>1,600 (Note 2)</td><td>1,600 (Note 2)</td></tr> <tr><td>FT-H13-FM2</td><td>3,500 (Note 2)</td><td>3,500 (Note 2)</td><td>3,500 (Note 2)</td><td>3,500 (Note 2)</td><td>3,500 (Note 2)</td><td>3,500 (Note 2)</td><td>3,500 (Note 2)</td></tr> </tbody> </table>	Fiber \ Mode	U-LG	LONG	STDF	STD	FAST	S-D	H-SP	FT-B8	3,500 (Note 2)	3,500 (Note 2)	3,500 (Note 2)	3,500 (Note 2)	3,500 (Note 2)	3,500 (Note 2)	3,500 (Note 2)	FT-FM2	3,500 (Note 2)	3,500 (Note 2)	3,500 (Note 2)	3,500 (Note 2)	3,500 (Note 2)	3,500 (Note 2)	3,500 (Note 2)	FT-R80	3,500 (Note 2)	3,500 (Note 2)	3,500 (Note 2)	3,500 (Note 2)	3,500 (Note 2)	3,500 (Note 2)	3,500 (Note 2)	FT-W8	3,500 (Note 2)	3,500 (Note 2)	3,500 (Note 2)	3,500 (Note 2)	3,500 (Note 2)	3,500 (Note 2)	3,500 (Note 2)	FT-P80	3,500 (Note 2)	3,500 (Note 2)	3,500 (Note 2)	3,500 (Note 2)	3,500 (Note 2)	3,500 (Note 2)	3,500 (Note 2)	FT-P60	3,500 (Note 2)	3,500 (Note 2)	3,500 (Note 2)	3,500 (Note 2)	3,500 (Note 2)	3,500 (Note 2)	3,500 (Note 2)	FT-P81X	1,600 (Note 2)	1,600 (Note 2)	1,600 (Note 2)	1,600 (Note 2)	1,600 (Note 2)	1,600 (Note 2)	1,600 (Note 2)	FT-H35-M2	3,500 (Note 2)	3,500 (Note 2)	3,500 (Note 2)	3,500 (Note 2)	3,500 (Note 2)	3,500 (Note 2)	3,500 (Note 2)	FT-H20W-M1	1,600 (Note 2)	1,600 (Note 2)	1,600 (Note 2)	1,600 (Note 2)	1,600 (Note 2)	1,500	1,600 (Note 2)	FT-H20-M1	1,600 (Note 2)	1,600 (Note 2)	1,600 (Note 2)	1,600 (Note 2)	1,600 (Note 2)	1,600 (Note 2)	1,600 (Note 2)	FT-H13-FM2	3,500 (Note 2)	3,500 (Note 2)	3,500 (Note 2)	3,500 (Note 2)	3,500 (Note 2)	3,500 (Note 2)	3,500 (Note 2)	
Fiber \ Mode	U-LG	LONG	STDF	STD	FAST	S-D	H-SP																																																																																												
FT-B8	3,500 (Note 2)	3,500 (Note 2)	3,500 (Note 2)	3,500 (Note 2)	3,500 (Note 2)	3,500 (Note 2)	3,500 (Note 2)																																																																																												
FT-FM2	3,500 (Note 2)	3,500 (Note 2)	3,500 (Note 2)	3,500 (Note 2)	3,500 (Note 2)	3,500 (Note 2)	3,500 (Note 2)																																																																																												
FT-R80	3,500 (Note 2)	3,500 (Note 2)	3,500 (Note 2)	3,500 (Note 2)	3,500 (Note 2)	3,500 (Note 2)	3,500 (Note 2)																																																																																												
FT-W8	3,500 (Note 2)	3,500 (Note 2)	3,500 (Note 2)	3,500 (Note 2)	3,500 (Note 2)	3,500 (Note 2)	3,500 (Note 2)																																																																																												
FT-P80	3,500 (Note 2)	3,500 (Note 2)	3,500 (Note 2)	3,500 (Note 2)	3,500 (Note 2)	3,500 (Note 2)	3,500 (Note 2)																																																																																												
FT-P60	3,500 (Note 2)	3,500 (Note 2)	3,500 (Note 2)	3,500 (Note 2)	3,500 (Note 2)	3,500 (Note 2)	3,500 (Note 2)																																																																																												
FT-P81X	1,600 (Note 2)	1,600 (Note 2)	1,600 (Note 2)	1,600 (Note 2)	1,600 (Note 2)	1,600 (Note 2)	1,600 (Note 2)																																																																																												
FT-H35-M2	3,500 (Note 2)	3,500 (Note 2)	3,500 (Note 2)	3,500 (Note 2)	3,500 (Note 2)	3,500 (Note 2)	3,500 (Note 2)																																																																																												
FT-H20W-M1	1,600 (Note 2)	1,600 (Note 2)	1,600 (Note 2)	1,600 (Note 2)	1,600 (Note 2)	1,500	1,600 (Note 2)																																																																																												
FT-H20-M1	1,600 (Note 2)	1,600 (Note 2)	1,600 (Note 2)	1,600 (Note 2)	1,600 (Note 2)	1,600 (Note 2)	1,600 (Note 2)																																																																																												
FT-H13-FM2	3,500 (Note 2)	3,500 (Note 2)	3,500 (Note 2)	3,500 (Note 2)	3,500 (Note 2)	3,500 (Note 2)	3,500 (Note 2)																																																																																												
Side-view lens	<p>FX-SV1</p>  <p>Beam axis is bent by 90°.</p> <ul style="list-style-type: none"> Ambient temperature: -60 to $+300$ °C -76 to $+572$ °F (Note 5) 	<p>Sensing range for red LED type (mm) [Lens on both sides] (Note 3)</p> <table border="1"> <thead> <tr> <th>Fiber \ Mode</th> <th>U-LG</th> <th>LONG</th> <th>STDF</th> <th>STD</th> <th>FAST</th> <th>S-D</th> <th>H-SP</th> </tr> </thead> <tbody> <tr><td>FT-B8</td><td>1,450</td><td>1,100</td><td>660</td><td>530</td><td>400</td><td>186</td><td>180</td></tr> <tr><td>FT-FM2</td><td>1,800</td><td>1,200</td><td>810</td><td>600</td><td>440</td><td>210</td><td>210</td></tr> <tr><td>FT-T80</td><td>1,800</td><td>1,200</td><td>810</td><td>600</td><td>440</td><td>210</td><td>210</td></tr> <tr><td>FT-W8</td><td>1,300</td><td>900</td><td>600</td><td>450</td><td>330</td><td>160</td><td>160</td></tr> <tr><td>FT-P80</td><td>1,800</td><td>1,200</td><td>810</td><td>600</td><td>440</td><td>210</td><td>210</td></tr> <tr><td>FT-P60</td><td>850</td><td>650</td><td>400</td><td>300</td><td>200</td><td>130</td><td>120</td></tr> <tr><td>FT-P81X</td><td>1,800</td><td>1,200</td><td>810</td><td>600</td><td>440</td><td>200</td><td>200</td></tr> <tr><td>FT-H35-M2</td><td>840</td><td>550</td><td>370</td><td>280</td><td>200</td><td>90</td><td>90</td></tr> <tr><td>FT-H20W-M1</td><td>400</td><td>310</td><td>180</td><td>140</td><td>100</td><td>50</td><td>50</td></tr> <tr><td>FT-H20-M1</td><td>840</td><td>550</td><td>370</td><td>280</td><td>200</td><td>90</td><td>90</td></tr> </tbody> </table>	Fiber \ Mode	U-LG	LONG	STDF	STD	FAST	S-D	H-SP	FT-B8	1,450	1,100	660	530	400	186	180	FT-FM2	1,800	1,200	810	600	440	210	210	FT-T80	1,800	1,200	810	600	440	210	210	FT-W8	1,300	900	600	450	330	160	160	FT-P80	1,800	1,200	810	600	440	210	210	FT-P60	850	650	400	300	200	130	120	FT-P81X	1,800	1,200	810	600	440	200	200	FT-H35-M2	840	550	370	280	200	90	90	FT-H20W-M1	400	310	180	140	100	50	50	FT-H20-M1	840	550	370	280	200	90	90									
Fiber \ Mode	U-LG	LONG	STDF	STD	FAST	S-D	H-SP																																																																																												
FT-B8	1,450	1,100	660	530	400	186	180																																																																																												
FT-FM2	1,800	1,200	810	600	440	210	210																																																																																												
FT-T80	1,800	1,200	810	600	440	210	210																																																																																												
FT-W8	1,300	900	600	450	330	160	160																																																																																												
FT-P80	1,800	1,200	810	600	440	210	210																																																																																												
FT-P60	850	650	400	300	200	130	120																																																																																												
FT-P81X	1,800	1,200	810	600	440	200	200																																																																																												
FT-H35-M2	840	550	370	280	200	90	90																																																																																												
FT-H20W-M1	400	310	180	140	100	50	50																																																																																												
FT-H20-M1	840	550	370	280	200	90	90																																																																																												
Expansion lens for vacuum fiber (Note 1)	<p>FV-LE1</p>  <p>Sensing range increases by 4 times or more.</p> <ul style="list-style-type: none"> Ambient temperature: -60 to $+350$ °C -76 to $+662$ °F (Note 5) 	<p>Sensing range for red LED type (mm) [Lens on both sides] (Note 3, 4)</p> <table border="1"> <thead> <tr> <th>Fiber \ Mode</th> <th>U-LG</th> <th>LONG</th> <th>STDF</th> <th>STD</th> <th>FAST</th> <th>S-D</th> <th>H-SP</th> </tr> </thead> <tbody> <tr><td>FT-H30-M1V-S</td><td>1,600</td><td>1,200</td><td>650</td><td>450</td><td>300</td><td>150</td><td>200</td></tr> </tbody> </table>	Fiber \ Mode	U-LG	LONG	STDF	STD	FAST	S-D	H-SP	FT-H30-M1V-S	1,600	1,200	650	450	300	150	200																																																																																	
Fiber \ Mode	U-LG	LONG	STDF	STD	FAST	S-D	H-SP																																																																																												
FT-H30-M1V-S	1,600	1,200	650	450	300	150	200																																																																																												
Vacuum resistant side-view lens (Note 1)	<p>FV-SV2</p>  <p>Beam axis is bent by 90°.</p> <ul style="list-style-type: none"> Ambient temperature: -60 to $+300$ °C -76 to $+572$ °F (Note 5) 	<p>Sensing range for red LED type (mm) [Lens on both sides] (Note 3, 4)</p> <table border="1"> <thead> <tr> <th>Fiber \ Mode</th> <th>U-LG</th> <th>LONG</th> <th>STDF</th> <th>STD</th> <th>FAST</th> <th>S-D</th> <th>H-SP</th> </tr> </thead> <tbody> <tr><td>FT-H30-M1V-S</td><td>1,600</td><td>1,200</td><td>650</td><td>450</td><td>300</td><td>150</td><td>200</td></tr> </tbody> </table>	Fiber \ Mode	U-LG	LONG	STDF	STD	FAST	S-D	H-SP	FT-H30-M1V-S	1,600	1,200	650	450	300	150	200																																																																																	
Fiber \ Mode	U-LG	LONG	STDF	STD	FAST	S-D	H-SP																																																																																												
FT-H30-M1V-S	1,600	1,200	650	450	300	150	200																																																																																												

- Notes: 1) Be careful when installing the thru-beam type fiber equipped with the expansion lens, as the beam envelope becomes narrow and alignment is difficult. Especially when installing a fiber with many cores (sharp bending fibers and heat-resistant glass fiber), please be sure to use it only after you have adjusted it sufficiently.
- 2) The fiber cable length practically limits the sensing range to 3,500 mm **137.795 in** long (FT-P81X, FT-H20W-M1 and FT-H20-M1: 1,600 mm **62.992 in**).
- 3) The sensing ranges are the values for red LED type amplifier. Please contact our office for details on sensing ranges for other types of amplifiers.
- 4) The fiber cable length for the FT-H30-M1V-S is 1 m **3.281 ft**. The sensing ranges in U-LG and LONG modes take into account the length of the FT-J8 atmospheric side fiber.
- 5) Refer to p.76~ for the ambient temperatures of fibers to be used in combination.

- FIBER SENSORS
- LASER SENSORS
- PHOTO-ELECTRIC SENSORS
- MICRO PHOTO-ELECTRIC SENSORS
- AREA SENSORS
- LIGHT CURTAINS
- PRESSURE / FLOW SENSORS
- INDUCTIVE PROXIMITY SENSORS
- PARTICULAR USE SENSORS
- SENSOR OPTIONS
- SIMPLE WIRE-SAVING UNITS
- WIRE-SAVING SYSTEMS
- MEASUREMENT SENSORS
- STATIC CONTROL DEVICES
- ENDOSCOPE
- LASER MARKERS
- PLC / TERMINALS
- HUMAN MACHINE INTERFACES
- ENERGY CONSUMPTION VISUALIZATION COMPONENTS
- FA COMPONENTS
- MACHINE VISION SYSTEMS
- UV CURING SYSTEMS
- Selection Guide
- Fibers
- Amplifiers
- FX-500
- FX-100
- FX-300
- FX-410
- FX-311
- FX-301-F7/ FX-301-F

FIBER OPTIONS

Lens (for reflective type fiber)

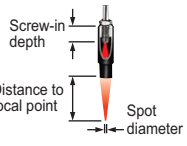
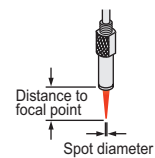
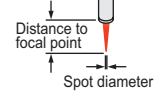
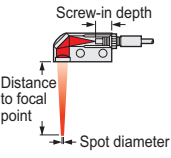
Designation	Model No.	Description															
For reflective type fiber	Pinpoint spot lens	FX-MR1	 <p>Pinpoint spot of $\varnothing 0.5$ mm $\varnothing 0.020$ in. Enables detection of minute objects or small marks.</p> <ul style="list-style-type: none"> Distance to focal point: 6 ± 1 mm 0.236 ± 0.039 in Applicable fibers: FD-WG4, FD-G4 Ambient temperature: -40 to $+70$ °C -40 to $+158$ °F (Note 2) 														
	Zoom lens	FX-MR2	 <p>The spot diameter is adjustable from $\varnothing 0.7$ to $\varnothing 2$ mm $\varnothing 0.028$ to $\varnothing 0.079$ in according to how much the fiber is screwed in.</p> <ul style="list-style-type: none"> Applicable fibers: FD-WG4, FD-G4 Ambient temperature: -40 to $+70$ °C -40 to $+158$ °F (Note 2) Accessory: MS-EX-3 (mounting bracket) <p>Sensing range for red LED type (Note 1)</p> <table border="1"> <thead> <tr> <th>Screw-in depth</th> <th>Distance to focal point</th> <th>Spot diameter</th> </tr> </thead> <tbody> <tr> <td>7 mm 0.276 in</td> <td>$\varnothing 18.5$ mm $\varnothing 0.728$ in approx.</td> <td>$\varnothing 0.7$ mm $\varnothing 0.028$ in</td> </tr> <tr> <td>12 mm 0.472 in</td> <td>$\varnothing 27$ mm $\varnothing 1.063$ in approx.</td> <td>$\varnothing 1.2$ mm $\varnothing 0.047$ in</td> </tr> <tr> <td>14 mm 0.551 in</td> <td>$\varnothing 43$ mm $\varnothing 1.693$ in approx.</td> <td>$\varnothing 2.0$ mm $\varnothing 0.079$ in</td> </tr> </tbody> </table>	Screw-in depth	Distance to focal point	Spot diameter	7 mm 0.276 in	$\varnothing 18.5$ mm $\varnothing 0.728$ in approx.	$\varnothing 0.7$ mm $\varnothing 0.028$ in	12 mm 0.472 in	$\varnothing 27$ mm $\varnothing 1.063$ in approx.	$\varnothing 1.2$ mm $\varnothing 0.047$ in	14 mm 0.551 in	$\varnothing 43$ mm $\varnothing 1.693$ in approx.	$\varnothing 2.0$ mm $\varnothing 0.079$ in		
	Screw-in depth	Distance to focal point	Spot diameter														
	7 mm 0.276 in	$\varnothing 18.5$ mm $\varnothing 0.728$ in approx.	$\varnothing 0.7$ mm $\varnothing 0.028$ in														
	12 mm 0.472 in	$\varnothing 27$ mm $\varnothing 1.063$ in approx.	$\varnothing 1.2$ mm $\varnothing 0.047$ in														
14 mm 0.551 in	$\varnothing 43$ mm $\varnothing 1.693$ in approx.	$\varnothing 2.0$ mm $\varnothing 0.079$ in															
Finest spot lens	FX-MR3	 <p>Extremely fine spot of $\varnothing 0.3$ mm $\varnothing 0.012$ in approx. achieved.</p> <ul style="list-style-type: none"> Applicable fibers: FD-WG4, FD-G4, FD-EG1, FD-EG2, FD-EG3, FD-G6X, FD-G6 Ambient temperature: -40 to $+70$ °C -40 to $+158$ °F (Note 2) <p>Sensing range for red LED type (Note 1)</p> <table border="1"> <thead> <tr> <th>Fiber</th> <th>Distance to focal point</th> <th>Spot diameter</th> </tr> </thead> <tbody> <tr> <td>FD-EG3</td> <td>7.5 ± 0.5 mm 0.295 ± 0.020 in</td> <td>$\varnothing 0.15$ mm $\varnothing 0.006$ in approx</td> </tr> <tr> <td>FD-EG2</td> <td>7.5 ± 0.5 mm 0.295 ± 0.020 in</td> <td>$\varnothing 0.2$ mm $\varnothing 0.008$ in approx</td> </tr> <tr> <td>FD-EG1</td> <td>7.5 ± 0.5 mm 0.295 ± 0.020 in</td> <td>$\varnothing 0.3$ mm $\varnothing 0.012$ in approx</td> </tr> <tr> <td>FD-WG4/G4/G6X/G6</td> <td>7.5 ± 0.5 mm 0.295 ± 0.020 in</td> <td>$\varnothing 0.5$ mm $\varnothing 0.020$ in approx</td> </tr> </tbody> </table>	Fiber	Distance to focal point	Spot diameter	FD-EG3	7.5 ± 0.5 mm 0.295 ± 0.020 in	$\varnothing 0.15$ mm $\varnothing 0.006$ in approx	FD-EG2	7.5 ± 0.5 mm 0.295 ± 0.020 in	$\varnothing 0.2$ mm $\varnothing 0.008$ in approx	FD-EG1	7.5 ± 0.5 mm 0.295 ± 0.020 in	$\varnothing 0.3$ mm $\varnothing 0.012$ in approx	FD-WG4/G4/G6X/G6	7.5 ± 0.5 mm 0.295 ± 0.020 in	$\varnothing 0.5$ mm $\varnothing 0.020$ in approx
Fiber	Distance to focal point	Spot diameter															
FD-EG3	7.5 ± 0.5 mm 0.295 ± 0.020 in	$\varnothing 0.15$ mm $\varnothing 0.006$ in approx															
FD-EG2	7.5 ± 0.5 mm 0.295 ± 0.020 in	$\varnothing 0.2$ mm $\varnothing 0.008$ in approx															
FD-EG1	7.5 ± 0.5 mm 0.295 ± 0.020 in	$\varnothing 0.3$ mm $\varnothing 0.012$ in approx															
FD-WG4/G4/G6X/G6	7.5 ± 0.5 mm 0.295 ± 0.020 in	$\varnothing 0.5$ mm $\varnothing 0.020$ in approx															
Finest spot lens	FX-MR6	 <p>Extremely fine spot of $\varnothing 0.1$ mm $\varnothing 0.004$ in approx. achieved.</p> <ul style="list-style-type: none"> Applicable fibers: FD-WG4, FD-G4, FD-EG1, FD-EG2, FD-EG3, FD-G6X, FD-G6 Ambient temperature: -20 to $+60$ °C -4 to $+140$ °F (Note 2) <p>Sensing range for red LED type (Note 1)</p> <table border="1"> <thead> <tr> <th>Fiber</th> <th>Distance to focal point</th> <th>Spot diameter</th> </tr> </thead> <tbody> <tr> <td>FD-EG3</td> <td>7 ± 0.5 mm 0.276 ± 0.020 in</td> <td>$\varnothing 0.1$ mm $\varnothing 0.004$ in approx</td> </tr> <tr> <td>FD-EG2</td> <td>7 ± 0.5 mm 0.276 ± 0.020 in</td> <td>$\varnothing 0.15$ mm $\varnothing 0.006$ in approx</td> </tr> <tr> <td>FD-EG1</td> <td>7 ± 0.5 mm 0.276 ± 0.020 in</td> <td>$\varnothing 0.2$ mm $\varnothing 0.008$ in approx</td> </tr> <tr> <td>FD-WG4/G4/G6X/G6</td> <td>7 ± 0.5 mm 0.276 ± 0.020 in</td> <td>$\varnothing 0.4$ mm $\varnothing 0.016$ in approx</td> </tr> </tbody> </table>	Fiber	Distance to focal point	Spot diameter	FD-EG3	7 ± 0.5 mm 0.276 ± 0.020 in	$\varnothing 0.1$ mm $\varnothing 0.004$ in approx	FD-EG2	7 ± 0.5 mm 0.276 ± 0.020 in	$\varnothing 0.15$ mm $\varnothing 0.006$ in approx	FD-EG1	7 ± 0.5 mm 0.276 ± 0.020 in	$\varnothing 0.2$ mm $\varnothing 0.008$ in approx	FD-WG4/G4/G6X/G6	7 ± 0.5 mm 0.276 ± 0.020 in	$\varnothing 0.4$ mm $\varnothing 0.016$ in approx
Fiber	Distance to focal point	Spot diameter															
FD-EG3	7 ± 0.5 mm 0.276 ± 0.020 in	$\varnothing 0.1$ mm $\varnothing 0.004$ in approx															
FD-EG2	7 ± 0.5 mm 0.276 ± 0.020 in	$\varnothing 0.15$ mm $\varnothing 0.006$ in approx															
FD-EG1	7 ± 0.5 mm 0.276 ± 0.020 in	$\varnothing 0.2$ mm $\varnothing 0.008$ in approx															
FD-WG4/G4/G6X/G6	7 ± 0.5 mm 0.276 ± 0.020 in	$\varnothing 0.4$ mm $\varnothing 0.016$ in approx															
Zoom lens (Side-view type)	FX-MR5	 <p>FX-MR2 is converted into a side-view type and can be mounted in a very small space.</p> <ul style="list-style-type: none"> Applicable fibers: FD-WG4, FD-G4 Ambient temperature: -40 to $+70$ °C -40 to $+158$ °F (Note 2) <p>Sensing range for red LED type (Note 1)</p> <table border="1"> <thead> <tr> <th>Screw-in depth</th> <th>Distance to focal point</th> <th>Spot diameter</th> </tr> </thead> <tbody> <tr> <td>8 mm 0.315 in</td> <td>13 mm 0.512 in approx.</td> <td>$\varnothing 0.5$ mm $\varnothing 0.020$ in</td> </tr> <tr> <td>10 mm 0.394 in</td> <td>15 mm 0.591 in approx.</td> <td>$\varnothing 0.8$ mm $\varnothing 0.031$ in</td> </tr> <tr> <td>14 mm 0.551 in</td> <td>30 mm 1.181 in approx.</td> <td>$\varnothing 3.0$ mm $\varnothing 0.118$ in</td> </tr> </tbody> </table>	Screw-in depth	Distance to focal point	Spot diameter	8 mm 0.315 in	13 mm 0.512 in approx.	$\varnothing 0.5$ mm $\varnothing 0.020$ in	10 mm 0.394 in	15 mm 0.591 in approx.	$\varnothing 0.8$ mm $\varnothing 0.031$ in	14 mm 0.551 in	30 mm 1.181 in approx.	$\varnothing 3.0$ mm $\varnothing 0.118$ in			
Screw-in depth	Distance to focal point	Spot diameter															
8 mm 0.315 in	13 mm 0.512 in approx.	$\varnothing 0.5$ mm $\varnothing 0.020$ in															
10 mm 0.394 in	15 mm 0.591 in approx.	$\varnothing 0.8$ mm $\varnothing 0.031$ in															
14 mm 0.551 in	30 mm 1.181 in approx.	$\varnothing 3.0$ mm $\varnothing 0.118$ in															

Notes: 1) The sensing ranges are the values when used in combination with red LED type amplifier. Please contact our office for details on sensing ranges for other types of amplifier.
 2) Refer p.76~ for the ambient temperatures of fibers to be used in combination.

Others

Designation	Model No.	Description		
Protective tube (For thru-beam type fiber)	FTP-500 (0.5 m 1.641 ft)	For M4 thread	FT-42 FT-FM2S4	
	FTP-1000 (1 m 3.281 ft)		FT-B8 FT-H13-FM2	
	FTP-1500 (1.5 m 4.922 ft)		FT-FM2 FT-P60	
	Protective tube (For reflective type fiber)	FTP-N500 (0.5 m 1.641 ft)	For M3 thread	FT-FM2S FT-P80
		FTP-N1000 (1 m 3.281 ft)		FT-31 FT-P40
FTP-N1500 (1.5 m 4.922 ft)		FT-NFM2 FT-T80		
Protective tube (For reflective type fiber)	FDP-500 (0.5 m 1.641 ft)	For M6 thread	FT-NFM2S FD-P40	
	FDP-1000 (1 m 3.281 ft)		FT-NFM2S4 FD-T40	
	FDP-1500 (1.5 m 4.922 ft)		FD-61 FD-FM2S4	
	Fiber bender	FDP-N500 (0.5 m 1.641 ft)	For M4 thread	FD-B8 FD-H13-FM2
		FDP-N1000 (1 m 3.281 ft)		FD-FM2 FD-P80
FDP-N1500 (1.5 m 4.922 ft)		FD-FM2S		
Fiber bender	FB-1	The fiber bender bends the sleeve part of the fiber head at the proper radius. (Note 1)		
Universal sensor mounting stand (Note 2)	MS-AJ1-F	Horizontal mounting type	Mounting stand assembly for fiber (For M3, M4 or M6 threaded head fiber)	
	MS-AJ2-F	Vertical mounting type		
Single core holder	FX-AT15A	The incident light intensity may vary when using a multi-core fiber or a thin type sharp bending fiber. This holder suppresses the variation in the incident light intensity. Brown.		

Notes: 1) Do not bend the sleeve part of any side-view type fiber or ultra-small diameter head type fiber.
 2) Refer to the universal sensor mounting stand **MS-AJ** series pages for details.

Protective tube

- FTP-□
- FDP-□



Fiber bender

- FB-1



Universal sensor mounting stand

Using the arm which enables adjustment in the horizontal direction, sensing can also be done from above an assembly line.

- **MS-AJ1-F** Swivel: 360° rotation

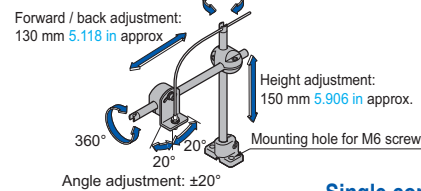

Single core holder

- **MS-AJ2-F** Swivel: 360° rotation
- **FX-AT15A**

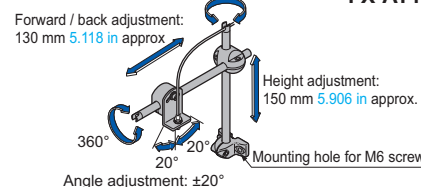

FIBER SENSORS

LASER SENSORS

PHOTO-ELECTRIC SENSORS

MICRO PHOTO-ELECTRIC SENSORS

AREA SENSORS

LIGHT CURTAINS

PRESSURE / FLOW SENSORS

INDUCTIVE PROXIMITY SENSORS

PARTICULAR USE SENSORS

SENSOR OPTIONS

SIMPLE WIRE-SAVING UNITS

WIRE-SAVING SYSTEMS

MEASUREMENT SENSORS

STATIC CONTROL DEVICES

ENDOSCOPE

LASER MARKERS

PLC / TERMINALS

HUMAN MACHINE INTERFACES

ENERGY CONSUMPTION VISUALIZATION COMPONENTS

FA COMPONENTS

MACHINE VISION SYSTEMS

UV CURING SYSTEMS

SELECTION GUIDE

FIBERS

AMPLIFIERS

FX-500

FX-100

FX-300

FX-410

FX-311

FX-301-F7/ FX-301-F

SPECIFICATIONS

FIBER SENSORS
LASER SENSORS
PHOTO-ELECTRIC SENSORS
MICRO PHOTO-ELECTRIC SENSORS
AREA SENSORS
LIGHT CURTAINS
PRESSURE / FLOW SENSORS
INDUCTIVE PROXIMITY SENSORS
PARTICULAR USE SENSORS
SENSOR OPTIONS
SIMPLE WIRE-SAVING UNITS
WIRE-SAVING SYSTEMS
MEASUREMENT SENSORS
STATIC CONTROL DEVICES
ENDOSCOPE
LASER MARKERS
PLC / TERMINALS
HUMAN MACHINE INTERFACES
ENERGY CONSUMPTION VISUALIZATION COMPONENTS
FA COMPONENTS
MACHINE VISION SYSTEMS
UV CURING SYSTEMS

Item	Mode No.	Type	Standard type				High-speed type	High-function type
			Red LED	Blue LED	Green LED	Infrared LED	FX-301-HS	FX-305
			NPN output	FX-301	FX-301B	FX-301G		
		PNP output	FX-301P	FX-301BP	FX-301GP	FX-301HP	FX-301P-HS	FX-305P
Supply voltage			12 to 24 V DC ±10 %				Ripple P-P 10 % or less	
Power consumption			<Red LED / Infrared LED type> Normal operation: 960 mW or less (Current consumption 40 mA or less at 24 V supply voltage) ECO mode: 600 mW or less (Current consumption 25 mA or less at 24 V supply voltage)				<Blue LED / Green LED type> Normal operation: 720 mW or less (Current consumption 30 mA or less at 24 V supply voltage) ECO mode: 430 mW or less (Current consumption 18 mA or less at 24 V supply voltage)	
Output			<NPN output type> NPN open-collector transistor • Maximum sink current: 100 mA (50 mA, if five, or more, amplifiers are connected in cascade.) • Applied voltage: 30 V DC or less (between output and 0 V) • Residual voltage: 1.5 V or less [at 100 mA (at 50 mA, if five, or more, amplifiers are connected in cascade) sink current.]				<NPN output type> NPN open-collector transistor 2 outputs • Maximum sink current: 50 mA each (Note 2) • Applied voltage: 30 V DC or less (between output and 0 V) • Residual voltage: 1.5 V or less [at 50 mA (Note 2)]	
			<PNP output type> PNP open-collector transistor • Maximum source current: 100 mA (50 mA, if five, or more, amplifiers are connected in cascade.) • Applied voltage: 30 V DC or less (between output and +V) • Residual voltage: 1.5 V or less [at 100 mA (at 50 mA, if five, or more, amplifiers are connected in cascade) source current.]				<PNP output type> PNP open-collector transistor 2 outputs • Maximum source current: 50 mA each (Note 2) • Applied voltage: 30 V DC or less (between output and +V) • Residual voltage: 1.5 V or less [at 50 mA (Note 2)]	
Output operation			Selectable either Light-ON or Dark-ON, with jog switch					
Short-circuit protection			Incorporated					
Response time			65 μs or less [H-SP (Red LED type only)], 150 μs or less (FAST), 250 μs or less [STD / S-D (Red LED type only)], 2 ms or less (LONG), selectable with jog switch				35 μs or less (H-SP), 150 μs or less (FAST), 250 μs or less (STD / S-D), 2 ms or less (LONG), selectable with jog switch	
Sensitivity setting			2-point teaching / Limit teaching / Manual adjustment / Full-auto teaching / Max. sensitivity teaching				Normal mode: 2-point teaching / Limit teaching / Full-auto teaching / Max. sensitivity teaching / Manual adjustment Window comparator mode: Teaching (1-point / 2-point / 3-point) / Manual adjustment	
Operation indicator			Orange LED (lights up when the output is ON)					
Stability indicator			Green LED (lights up under stable light received condition or stable dark condition)				_____	
MODE indicator			RUN: Green LED, TEACH • ADJ • L/D ON • TIMER • PRO: Yellow LED					
Digital display			4 digit red LED display					
Fine sensitivity adjustment function			Incorporated					
Timer function			Incorporated with variable ON-delay / OFF-delay / ONE SHOT timer, switchable either effective or ineffective. [Timer period: Red LED type; 0.5 ms approx., 1 to 9999 ms (Blue LED, Green LED, Infrared LED type; approx. 0.5 to 500 ms)]				Incorporated with variable ON-delay / OFF-delay / ONE SHOT / ON-delay • OFF-delay / ON-delay • ONE SHOT timer, switchable either effective or ineffective. (Timer period: Output 1; 0.5 ms, 1 to 9999 ms, Output 2; 0.5 ms, 1 to 500 ms)	
Light emitting amount selection function			Incorporated (Red LED type only) (Note 3) FAST, STD, LONG: 4 level, H-SP: 3 level, S-D: 2 level				Incorporated (Note 3) FAST, STD, STDF, LONG, U-LG: 4 level H-SP: 3 level	
Automatic interference prevention function			Incorporated (Up to four sets of fiber heads can be mounted close together. However, H-SP mode is 2 fiber heads.) (Note 4)				_____	
Environmental resistance	Ambient temperature		-10 to +55 °C +14 to +131 °F (If 4 to 7 units are connected in cascade: -10 to +50 °C +14 to +122 °F, if 8 to 16 units are connected in cascade: -10 to +45 °C +14 to +113 °F) (No dew condensation or icing allowed), Storage: -20 to +70 °C -4 to +158 °F					
	Ambient humidity		35 to 85 % RH, Storage: 35 to 85 % RH					
	Ambient illuminance		Incandescent light: 3,000 lx at the light-receiving face					
	Voltage withstandability		1,000 V AC for one min. between all supply terminals connected together and enclosure (Note 6)					
	Insulation resistance		20 MΩ, or more, with 250 V DC megger between all supply terminals connected together and enclosure (Note 6)					
	Vibration resistance		10 to 150 Hz frequency, 0.75 mm 0.030 in amplitude in X, Y and Z directions for two hours each					
	Shock resistance		98 m/s ² acceleration (10 G approx.) in X, Y and Z directions for five times each					
Emitting element (modulated)			Red LED	Blue LED	Green LED	Infrared LED	Red LED	Red LED
Peak emission wavelength			650 nm 0.026 mil	470 nm 0.019 mil	525 nm 0.021 mil	940 nm 0.037 mil	650 nm 0.026 mil	650 nm 0.026 mil
Material			Enclosure: Heat-resistant ABS, Case cover: Polycarbonate, MODE key: Acrylic, Jog switch: Heat-resistant ABS (FX-301B/G/H: Acrylic)					
Connecting method			Connector (Note 7)					
Cable length			Total length up to 100 m 328.084 ft (50 m 164.042 ft for 5 to 8 units, 20 m 65.617 ft for 9 to 16 units) is possible with 0.3 mm ² , or more, cable.					
Weight			Net weight: 20 g approx., Gross weight: 25 g approx.					
Accessory			FX-MB1 (amplifier protection seal): 1 set				FX-MB1 (amplifier protection seal): 1 set	

Notes: 1) Where measurement conditions have not been specified precisely, the conditions used were an ambient temperature of +23 °C +73.4 °F.
 2) 50 mA per output. 25 mA if five, or more, amplifiers are connected in cascade.
 3) The light emitting amount can be zero (emission halt) in all modes.
 4) When the power supply is switched on, the light emission timing is automatically set for interference prevention.
 5) When the interference prevention function "P-2" is set, the number of mountable fiber heads becomes double.
 Furthermore, take care that the response time also becomes double.
 6) The voltage withstandability and the insulation resistance values given in the above table are for the amplifier only.
 7) The cable for amplifier connection is not supplied as an accessory. Make sure to use the optional quick-connection cables given below.
 Main cable (3-core) for FX-301(P)(-HS): CN-73-C1 (Cable length 1 m 3.281 ft), CN-73-C2 (Cable length 2 m 6.562 ft), CN-73-C5 (Cable length 5 m 16.404 ft)
 Sub cable (1-core) for FX-301(P)(-HS): CN-71-C1 (Cable length 1 m 3.281 ft), CN-71-C2 (Cable length 2 m 6.562 ft), CN-71-C5 (Cable length 5 m 16.404 ft)
 Main cable (4-core) for FX-305(P): CN-74-C1 (Cable length 1 m 3.281 ft), CN-74-C2 (Cable length 2 m 6.562 ft), CN-74-C5 (Cable length 5 m 16.404 ft)
 Sub cable (2-core) for FX-305(P): CN-72-C1 (Cable length 1 m 3.281 ft), CN-72-C2 (Cable length 2 m 6.562 ft), CN-72-C5 (Cable length 5 m 16.404 ft)

I/O CIRCUIT AND WIRING DIAGRAMS

FX-301(-HS)

NPN output type

I/O circuit diagram

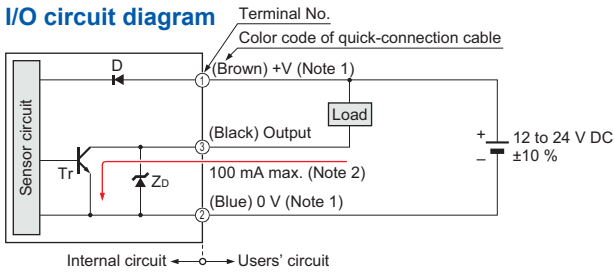

Notes: 1) The quick-connection sub cable does not have +V (brown) and 0 V (blue). The power is supplied from the connector of the main cable.
2) 50 mA max., if five amplifiers, or more, are connected together.

Symbols ... D : Reverse supply polarity protection diode
Zd : Surge absorption zener diode
Tr : NPN output transistor

Wiring diagram

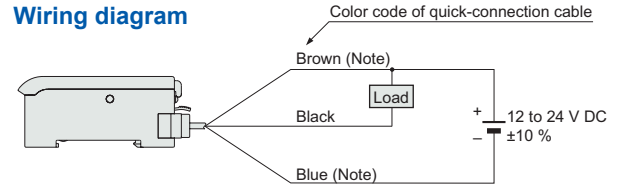

Note: The quick-connection sub cable does not have brown lead wire and blue lead wire.

Terminal arrangement diagram

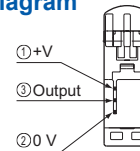

FX-301P(-HS)

PNP output type

I/O circuit diagram

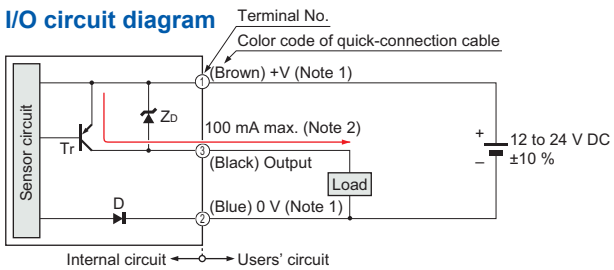

Notes: 1) The quick-connection sub cable does not have +V (brown) and 0 V (blue). The power is supplied from the connector of the main cable.
2) 50 mA max., if five amplifiers, or more, are connected together.

Symbols ... D : Reverse supply polarity protection diode
Zd : Surge absorption zener diode
Tr : PNP output transistor

Wiring diagram

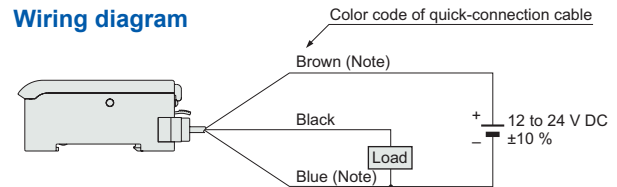

Note: The quick-connection sub cable does not have brown lead wire and blue lead wire.

Terminal arrangement diagram

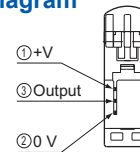

FX-305

NPN output type

I/O circuit diagram

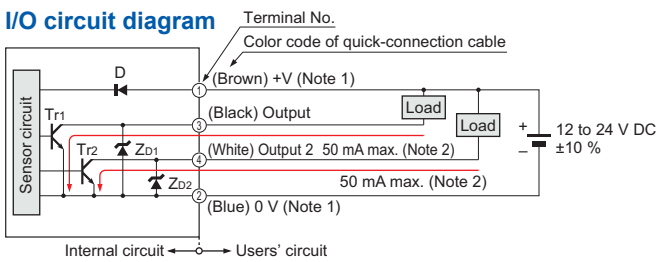

Notes: 1) The quick-connection sub cable does not have +V (brown) and 0 V (blue). The power is supplied from the connector of the main cable.
2) 25 mA max., if five amplifiers, or more, are connected together.

Symbols ... D : Reverse supply polarity protection diode
Zd1, Zd2 : Surge absorption zener diode
Tr1, Tr2 : NPN output transistor

Wiring diagram

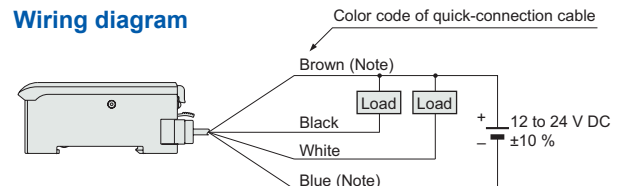

Note: The quick-connection sub cable does not have brown lead wire and blue lead wire.

Terminal arrangement diagram

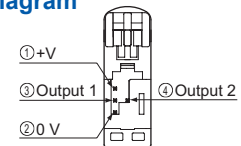

FX-305P

PNP output type

I/O circuit diagram

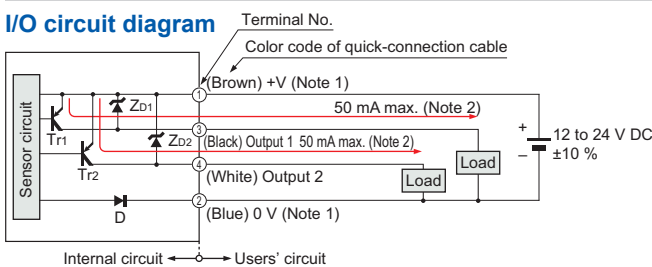

Notes: 1) The quick-connection sub cable does not have +V (brown) and 0 V (blue). The power is supplied from the connector of the main cable.
2) 25 mA max., if five amplifiers, or more, are connected together.

Symbols ... D : Reverse supply polarity protection diode
Zd1, Zd2 : Surge absorption zener diode
Tr1, Tr2 : PNP output transistor

Wiring diagram

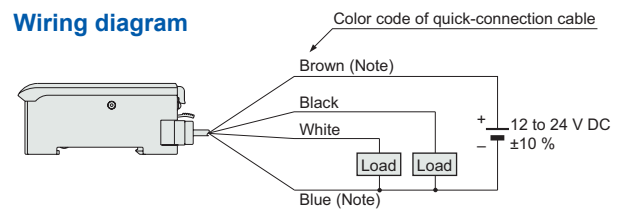

Note: The quick-connection sub cable does not have brown lead wire and blue lead wire.

Terminal arrangement diagram

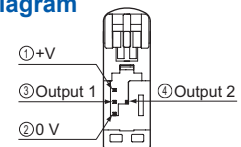

FIBER SENSORS

LASER SENSORS

PHOTO-ELECTRIC SENSORS

MICRO PHOTO-ELECTRIC SENSORS

AREA SENSORS

LIGHT CURTAINS

PRESSURE / FLOW SENSORS

INDUCTIVE PROXIMITY SENSORS

PARTICULAR USE SENSORS

SENSOR OPTIONS

SIMPLE WIRE-SAVING UNITS

WIRE-SAVING SYSTEMS

MEASUREMENT SENSORS

STATIC CONTROL DEVICES

ENDOSCOPE

LASER MARKERS

PLC / TERMINALS

HUMAN MACHINE INTERFACES

ENERGY CONSUMPTION VISUALIZATION COMPONENTS

FA COMPONENTS

MACHINE VISION SYSTEMS

UV CURING SYSTEMS

Selection Guide

Fibers

Amplifiers

FX-500

FX-100

FX-300

FX-410

FX-311

FX-301-F7/ FX-301-F

SENSING CHARACTERISTICS (TYPICAL)

The following sensing characteristics pertain to the FX-300 red LED type. Please contact our office for the sensing characteristics pertaining corresponding to types other than the red LED or to types not mentioned here.

Thru-beam type Parallel deviation

Sensing characteristics are listed by model No. in alphabetical order. (However, models with the same sensing characteristics are listed together.)

FT-A8 FT-WA8 Thru-beam type

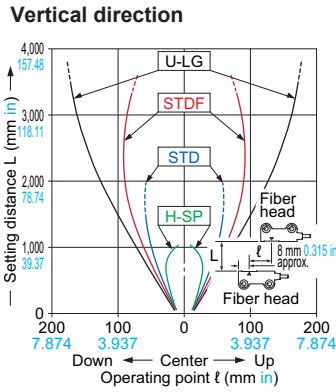
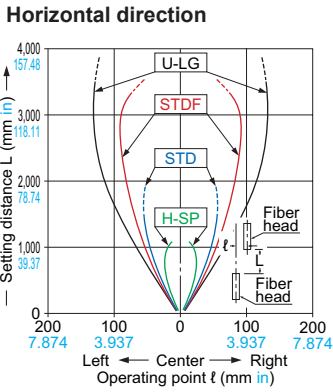

FT-B8 Thru-beam type

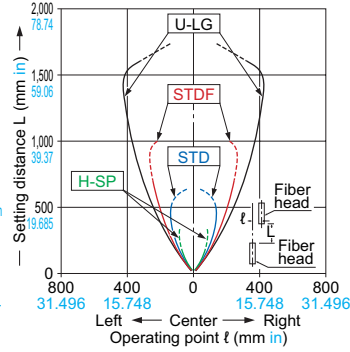

FT-FM2 FT-FM2S FT-FM2S4 FT-SFM2 FT-T80 Thru-beam type

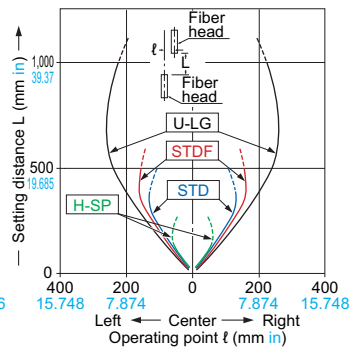

FT-NFM2 FT-NFM2S FT-NFM2S4 FT-SNFM2 Thru-beam type

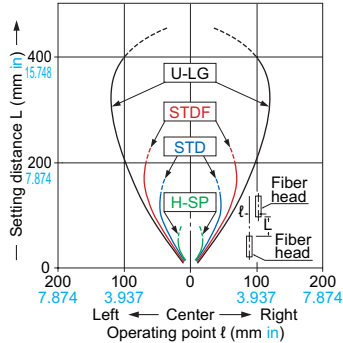

FT-P81X Thru-beam type

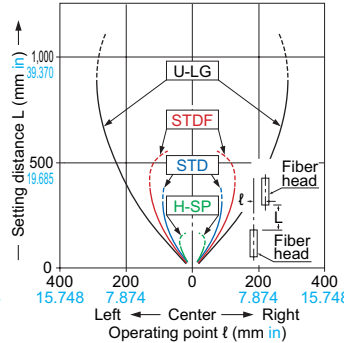

FT-W4 FT-WS4 Thru-beam type

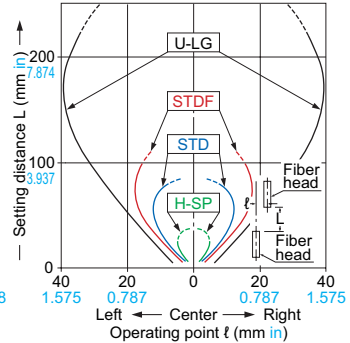

FT-W8 FT-WS8 Thru-beam type

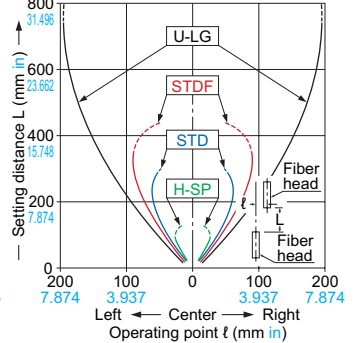

Reflective type Sensing fields

Sensing characteristics are listed by model No. in alphabetical order. (However, models with the same sensing characteristics are listed together.)

FD-B8 Reflective type

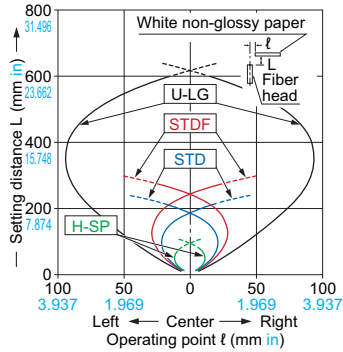

FD-FM2 Reflective type

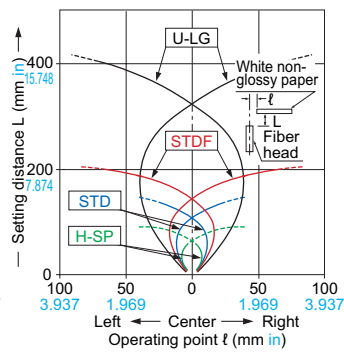

FD-G4 Reflective type

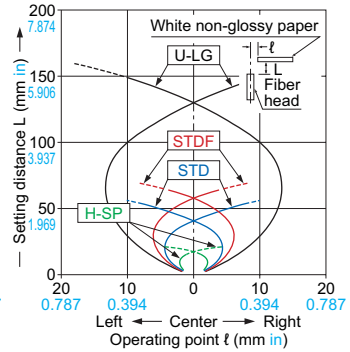

FD-G6X Reflective type

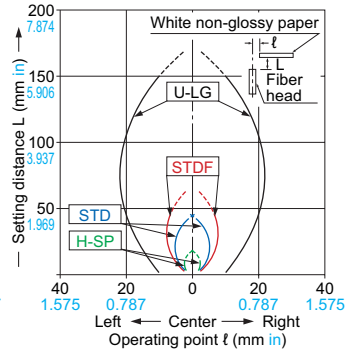

FD-NFM2 FD-NFM2S FD-NFM2S4 FD-SNFM2 FT-T40 Reflective type

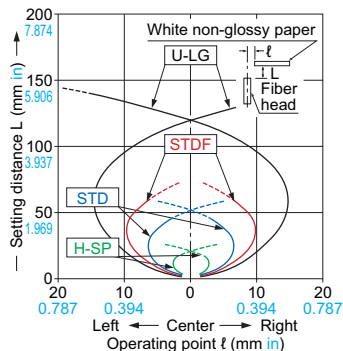

FD-P81X Reflective type

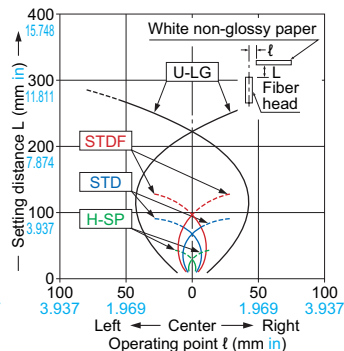

FD-W8 FD-WS8 FD-WT8 Reflective type

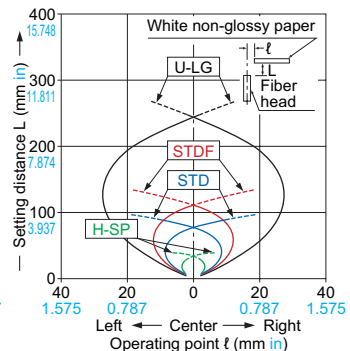

FD-WG4 FD-WSG4 Reflective type

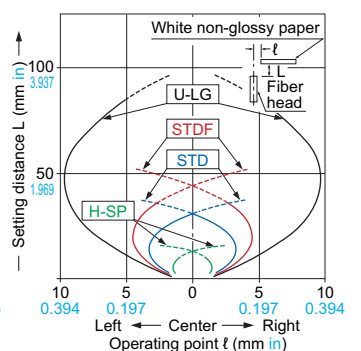

FIBER SENSORS
LASER SENSORS
PHOTO-ELECTRIC SENSORS
MICRO PHOTO-ELECTRIC SENSORS
AREA SENSORS
LIGHT CURTAINS
PRESSURE / FLOW SENSORS
INDUCTIVE PROXIMITY SENSORS
PARTICULAR USE SENSORS
SENSOR OPTIONS

SIMPLE WIRE-SAVING UNITS
WIRE-SAVING SYSTEMS
MEASUREMENT SENSORS
STATIC CONTROL DEVICES
ENDOSCOPE
LASER MARKERS
PLC / TERMINALS
HUMAN MACHINE INTERFACES
ENERGY CONSUMPTION VISUALIZATION COMPONENTS

FA COMPONENTS
MACHINE VISION SYSTEMS
UV CURING SYSTEMS
Selection Guide
Fibers
Amplifiers

FX-500
FX-100
FX-300
FX-410
FX-311
FX-301-F7/ FX-301-F

PRECAUTIONS FOR PROPER USE

Refer to General precautions, p.80~ for fiber precautions, and to the "PRO mode operation guide" on our website for details pertaining to operating instructions for the amplifier.



- Never use this product as a sensing device for personnel protection.
- In case of using sensing devices for personnel protection, use products which meet laws and standards, such as OSHA, ANSI or IEC etc., for personnel protection applicable in each region or country.

- The digital fiber sensor **FX-301(P)** has been modified since its production in June 2004. The explanations below are about the modified product.

Mounting

How to mount the amplifier

- ① Fit the rear part of the mounting section of the amplifier on a 35 mm 1.378 in width DIN rail.
- ② Press down the rear part of the mounting section of the unit on the 35 mm 1.378 in width DIN rail and fit the front part of the mounting section to the 35 mm 1.378 in width DIN rail.

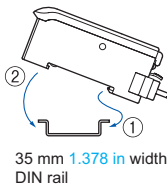

How to remove the amplifier

- ① Push the amplifier forward.
- ② Lift up the front part of the amplifier to remove it.

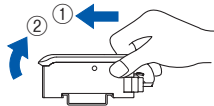

Note: Take care that if the front part is lifted without pushing the amplifier forward, the hook on the rear portion of the mounting section is likely to break.

Fiber installation

- Insert the fiber into the amplifier after attaching the attachment. Refer to the "Instruction Manual" included with the fiber for details.

- ① Push the fiber lock lever down.
- ② Slowly insert the fiber into the insertion slot until it stops. (Note 1)
- ③ Push the fiber lock lever back up until it stops.

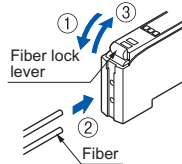

Notes: 1) Note that if the fiber is not fully inserted, the sensing distance will decrease. Also note that the flexible fiber may bend during insertion.
2) In case of coaxial reflective type fibers (**FD-G4**, **FD-FM2**, etc.), mount the central fiber (single-core) to the emitter part and the peripheral fiber (multi-core) to the receiver. Note that sensing precision will deteriorate when done in reverse.

Connection

- Make sure that the power supply is off while connecting or disconnecting the quick-connection cable.

Connection method

- ① Holding the connector of the quick-connection cable, align its projection with the groove at the top portion of the amplifier connector.
- ② Insert the connector till a click is felt.

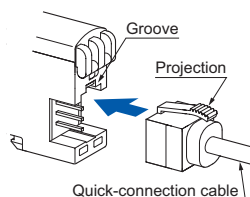

Disconnection method

- ① Pressing the projection at the top of the quick-connection cable, pull out the connector.

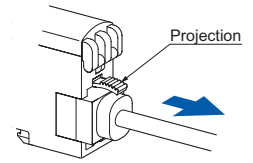

Note: Take care that if the connector is pulled out without pressing the projection, the projection may break. Do not use a quick-connection cable whose projection has broken. Further, do not pull by holding the cable, as this can cause a cable-break.

Cascading

- Make sure that the power supply is off while adding or removing the amplifiers.
- Make sure to check the allowable ambient temperature, as it depends on the number of amplifiers connected in cascade.
- In case two, or more, amplifiers are connected in cascade, make sure to mount them on a DIN rail.
- When the amplifiers move on the DIN rail depending on the attaching condition or the amplifiers are mounted close to each other in cascade, fit them between the optional end plates (**MS-DIN-E**) mounted at the two ends.
- Up to maximum 15 amplifiers can be added (total 16 amplifiers connected in cascade.)
- When connecting more than two amplifiers in cascade, use the sub cable (**CN-71-C□** / **CN-72-C□**) as the quick-connection cable for the second amplifier onwards.
- When connecting amplifiers not close to each other in parallel, be sure to mount the optional end plate (**MS-DIN-E**) at both sides of each amplifier or affix the communication window seal of the accessory amplifier protection seal (**FX-MB1**) to the communication windows.
- The settings other than the interference prevention function cannot be transmitted between **FX-301(P)**, **FX-301B/G/H(P)**, **FX-305(P)**. Therefore, in case both models of amplifiers are mounted in cascade, be sure to mount identical models together. However, the interference prevention function is not incorporated in the **FX-301(P)-HS**. Take care when the sensors are mounted in cascade.
- If the **FX-301(P)** updated version unit or the **FX-305(P)** is mounted with the **FX-301(P)** previous version unit or the **FX-301B/G/H(P)** in cascade, place the **FX-301(P)** updated version units and the **FX-305(P)** units to the right side (seen from the connector side) of the previous version units. For details, refer to "**Cautions on sensor connection in cascade**".
For a difference between the updated version unit and the previous version unit, refer to "**A difference between the updated version unit and the previous version unit**".
- The communication function of this product and that of the **FX-301(P)-F / F7** is different. If these models are mounted in cascade, affix the accessory fiber amplifier protection seal (**FX-MB1**) included in the **FX-301(P)** and **FX-305(P)** to the communication windows of the amplifiers.

FIBER SENSORS

LASER SENSORS

PHOTO-ELECTRIC SENSORS

MICRO PHOTO-ELECTRIC SENSORS

AREA SENSORS

LIGHT CURTAINS

PRESSURE / FLOW SENSORS

INDUCTIVE PROXIMITY SENSORS

PARTICULAR USE SENSORS

SENSOR OPTIONS

SIMPLE WIRE-SAVING UNITS

WIRE-SAVING SYSTEMS

MEASUREMENT SENSORS

STATIC CONTROL DEVICES

ENDOSCOPE

LASER MARKERS

PLC / TERMINALS

HUMAN MACHINE INTERFACES

ENERGY CONSUMPTION VISUALIZATION COMPONENTS

FA COMPONENTS

MACHINE VISION SYSTEMS

UV CURING SYSTEMS

Selection Guide

Fibers

Amplifiers

FX-500

FX-100

FX-300

FX-410

FX-311

FX-301-F7/
FX-301-F

PRECAUTIONS FOR PROPER USE

Refer to General precautions, p.80~ for fiber precautions, and to the "PRO mode operation guide" on our website for details pertaining to operating instructions for the amplifier.

Cascading method

- Mount the amplifiers, one by one, on the 35 mm 1.378 in width DIN rail.
- Slide the amplifiers next to each other, and connect the quick-connection cables.
- Mount the optional end plates (**MS-DIN-E**) at both the ends to hold the amplifiers between their flat sides.
- Tighten the screws to fix the end plates.

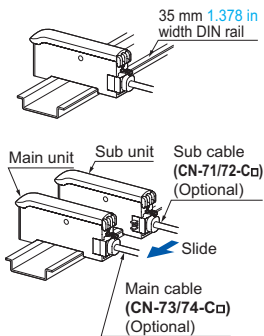

Dismantling

- Loosen the screws of the end plates.
- Remove the end plates.
- Slide the amplifiers and remove them one by one.

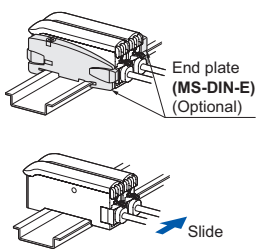

Cautions on sensor connection in cascade

- When the units in the group A and the group B shown in the table below are connected in cascade, connect them in cascade as **<Figure A>** shown below.

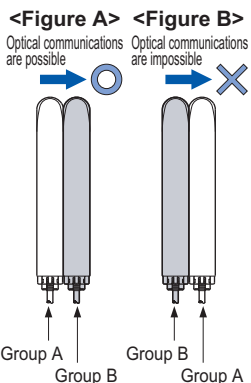

Group A	FX-301(P) : Previous version unit (Note 1), FX-301G(P)/B(P)/H(P) , FX-41□(P) , LS-401(P) (Note 2)
Group B	FX-301(P) : Updated version unit (Note 1), FX-305(P)

Notes: 1) For the difference between the updated version unit and the previous version unit, refer to "A difference between the updated version unit and the previous version unit".
 2) When **LS-401(P)** is connected with the digital fiber amplifier in cascade, be sure to locate **LS-401(P)** at the left-most position (when viewed from the connector side).

- When the units of the group A and the group B are connected in cascade as **<Figure B>** shown above, optical communications cannot be done. When the optical communications function is used, connect them as **<Figure A>** shown above. If the units cannot be placed as **<Figure A>**, the following measure ① or ② should be taken.

- Affix the communication window seal of the accessory fiber amplifier protection seal (**FX-MB1**) to the communication window of the **FX-301(P)** updated version unit or **FX-305(P)**.
- If the measure ① described above cannot be taken, change the optical communications spec. of the group B units.

How to change the communication specification of Group B

- Change the communication specification of Group B according to the following procedures. Make sure to set the communication specification to "3" (Group A communication specification) or "0" (Optical Communication Stop).

<Changing Procedure>

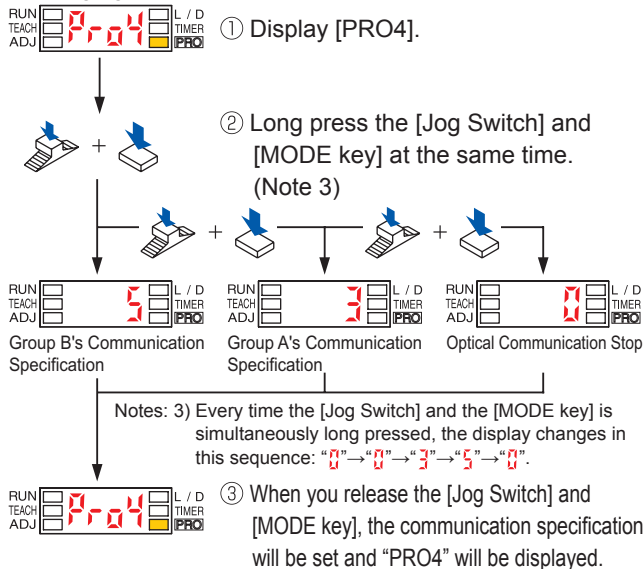

Notes: 3) Every time the [Jog Switch] and the [MODE key] is simultaneously long pressed, the display changes in this sequence: "0" → "3" → "5" → "0".
 Notes: 4) When the communication specification is set to "3" (Group A communication specification), make sure to tightly attach the products. Also make sure to take note of the following:
 • There are instances when the optical communication function cannot be used due to the usage environment, etc.
 • Do not perform batch channel loading or saving.

Part description

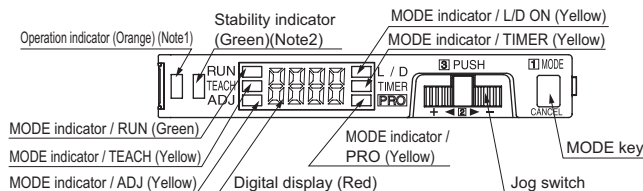

Notes: 1) **FX-305(P)**; Output 1 operation indicator (Orange)
 2) **FX-305(P)**; Output 2 operation indicator (Orange)

Operation procedure

- When the power supply is switched on, communication self-check is carried out and normal condition is displayed [MODE indicator / RUN (green)] lights up and the digital display shows the incident light intensity.
- When the MODE key is pressed, the mode will change as shown in the following diagram.

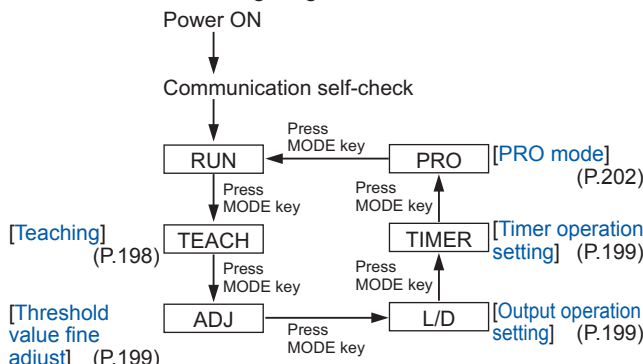

When Jog switch is pressed, the setting is confirmed.
 When MODE key is pressed for 2 sec., or more, the sensor returns to the 'RUN' mode.
 Cancellation is possible by pressing MODE key during setting.

- FIBER SENSORS
- LASER SENSORS
- PHOTO-ELECTRIC SENSORS
- MICRO PHOTO-ELECTRIC SENSORS
- AREA SENSORS
- LIGHT CURTAINS
- PRESSURE / FLOW SENSORS
- INDUCTIVE PROXIMITY SENSORS
- PARTICULAR USE SENSORS
- SENSOR OPTIONS
- WIRE-SAVING UNITS
- WIRE-SAVING SYSTEMS
- MEASURE-MENT SENSORS
- STATIC CONTROL DEVICES
- ENDSCOPE
- LASER MARKERS
- PLC / TERMINALS
- HUMAN MACHINE INTERFACES
- ENERGY CONSUMPTION VISUALIZATION COMPONENTS
- FA COMPONENTS
- MACHINE VISION SYSTEMS
- UV CURING SYSTEMS

- Selection Guide
- Fibers
- Amplifiers
- FX-500
- FX-100
- FX-300
- FX-410
- FX-311
- FX-301-F7/ FX-301-F

PRECAUTIONS FOR PROPER USE

Refer to General precautions, p.80~ for fiber precautions, and to the "PRO mode operation guide" on our website for details pertaining to operating instructions for the amplifier.

For FX-305(P)









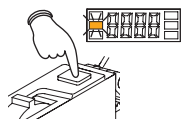

The **FX-305(P)** is equipped with two independent outputs, but the items that can be set in output 1 and output 2 respectively are only the following.
 The items other than those are common.
 ① Threshold value ② Output operation
 ③ Timer operation and Timer period ④ Sensing mode

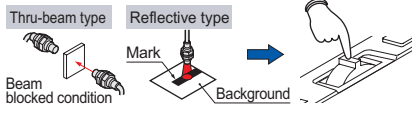
Teaching

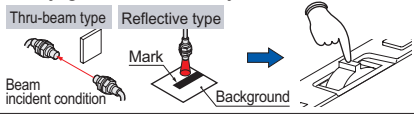
- The threshold values can be set by 2-point teaching, limit teaching, full-auto teaching or window comparator mode (1-point, 2-point, 3-point teaching) [only for **FX-305(P)**], when the MODE indicator / TEACH (yellow) lights up.

In case of 2-point teaching







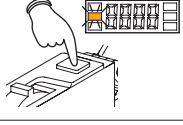

- This is the method of setting the threshold value by teaching two levels, corresponding to the object present and object absent conditions. Normally, setting is done by this method.

Step	Description	Display
①	Set the fiber within the sensing range. Press MODE key to light up MODE indicator / TEACH (yellow). 	
②	For FX-305(P) , select either Output 1 "Out 1" or Output 2 "Out 2" beforehand, press jog switch in the object present condition. If the teaching is accepted, the read incident light intensity blinks in the digital display. 	
③	MODE indicator / TEACH (yellow) blinks. Press jog switch in the object absent condition. 	
④	If the teaching is accepted, the read incident light intensity blinks in the digital display and the threshold value is set at the mid-value between the incident light intensities in the object present and the object absent conditions. After this, the judgment on the stability of sensing is displayed. • In case stable sensing is possible: "Good" is displayed. • In case stable sensing is not possible: "Bad" blinks.	 
⑤	The threshold value is displayed.	
⑥	"...." blinks in the digital display. (only FX-301B/G/H)	
⑦	The incident light intensity appears in the digital display and the setting is complete.	

- Notes: 1) Do not move or bend the fiber cable after the sensitivity setting. Detection may become unstable.
 2) In case a reflective-type fiber is used, maximum sensitivity will be set if the jog switch is pushed while in no work status in procedure ② and ③.

In case of full auto-teaching

- Full auto-teaching is used when it is desired to set the threshold value without stopping the assembly line, with the object in the moving condition.

Step	Description	Display
①	Set the fiber within the sensing range. Press MODE key to light up MODE indicator / TEACH (yellow). 	
②	For FX-305(P) , select either Output 1 "Out 1" or Output 2 "Out 2" beforehand, press the jog switch continuously for 0.5 sec. or more with the object moving on the assembly line. (The incident light intensity is displayed during sampling.)	
③	"Auto" is displayed on the digital display. Release the jog switch when the object has passed.	
④	If the teaching is accepted, the read incident light intensity blinks in the digital display and the threshold value is set at the mid-value between the incident light intensities in the object present and the object absent conditions. After this, the judgment on the stability of sensing is displayed. • In case stable sensing is possible: "Good" is displayed. • In case stable sensing is not possible: "Bad" blinks.	 
⑤	The threshold value is displayed.	
⑥	"...." blinks in the digital display. (only FX-301B/G/H)	
⑦	The incident light intensity appears in the digital display and the setting is complete.	

- Notes: 1) The threshold value's shift amount can be selected in PRO mode. Refer to the "PRO Mode Operation Guide" for more details pertaining to setting instructions. (Increments of 5 % between -45 and 45 % for setting possible. 0 % default.)
 2) Do not move or bend the fiber cable after the sensitivity setting. Detection may become unstable.

FIBER SENSORS

LASER SENSORS

PHOTO-ELECTRIC SENSORS

MICRO PHOTO-ELECTRIC SENSORS

AREA SENSORS

LIGHT CURTAINS

PRESSURE / FLOW SENSORS

INDUCTIVE PROXIMITY SENSORS

PARTICULAR USE SENSORS

SENSOR OPTIONS

SIMPLE WIRE-SAVING UNITS

WIRE-SAVING SYSTEMS

MEASUREMENT SENSORS

STATIC CONTROL DEVICES

ENDOSCOPE

LASER MARKERS

PLC / TERMINALS

HUMAN MACHINE INTERFACES

ENERGY CONSUMPTION VISUALIZATION COMPONENTS

FA COMPONENTS

MACHINE VISION SYSTEMS

UV CURING SYSTEMS

Selection Guide

Fibers

Amplifiers

FX-500

FX-100

FX-300

FX-410

FX-311

FX-301-F7/
FX-301-F

PRECAUTIONS FOR PROPER USE

Refer to General precautions, p.80~ for fiber precautions, and to the "PRO mode operation guide" on our website for details pertaining to operating instructions for the amplifier.

In case of limit teaching

- This is the method of setting the threshold value by teaching only the object absent condition (stable incident light condition). This is used for detection in the presence of a background body or for detection of small objects.

Step	Description	Display
①	Set the fiber within the sensing range. Press MODE key to light up MODE indicator / TEACH (yellow).	
②	For FX-305(P) , select either Output 1 "Out 1" or Output 2 "Out 2" beforehand, press jog switch in the object absent condition. If the teaching is accepted, the read incident light intensity blinks in the display. Thru-beam type Reflective type 	
③	MODE indicator / TEACH (yellow) blinks. Turn jog switch to the "+" side or "-" side.	
④	If jog switch is turned to the "+" side, " " scrolls (twice) the display from right to left (Note 1), and the threshold level is shifted to a value approx. 15 % higher (lower sensitivity) than that set at ②. (Note 2) This is used in case of reflective type fibers. If jog switch is turned to the "-" side, " " scrolls (twice) the display from left to right, and the threshold level is shifted to a value approx. 15 % lower (higher sensitivity) than that set at ②. (Note 2) This is used in case of thru-beam type fibers. 	
⑤	After this, the judgment on whether the setting shift amount can be shifted or not is displayed. • In case shifting is possible: "Good" blinks. • In case shifting is not possible: "Err" blinks.	
⑥	The threshold value is displayed.	
⑦	"....." blinks in the digital display. (only FX-301B/G/H)	
⑧	The incident light intensity appears in the digital display and the setting is complete.	

- Notes: 1) Scrolling display is not available in **FX-301B/G/H**.
 2) The approx. 15 % amount of shift is the initial value. The amount of shift can be changed in the PRO mode from approx. 5 to 80 % (5 % step). Refer to the "PRO Mode Operation Guide" for more details pertaining to setting instructions.
 3) Do not move or bend the fiber cable after the sensitivity setting. Detection may become unstable.

Please download the instruction manual from our website for setting of threshold value when used in combination with liquid level sensing fiber **FD-F8Y** and with pipe-mountable liquid level sensing fiber **FD-F4**.

For the wind comparator mode teaching in **FX-305(P)**, refer to the separately prepared "PRO Mode Operation Guide".

Threshold value fine adjustment

Step	Description	Display
①	Press MODE key to light up MODE indicator / ADJ (yellow). 	
②	For FX-305(P) , select either Output 1 "Out 1" or Output 2 "Out 2" beforehand, in case the threshold value is to be increased (sensitivity to be reduced), turn the jog switch to the "+" side to increase the threshold value slowly. If the jog switch is turned continuously to the "+" side, the threshold value increases rapidly. In case the threshold value is to be decreased (sensitivity to be increased), turn the jog switch to the "-" side to decrease the threshold value slowly. If the jog switch is turned continuously to the "-" side, the threshold value decreases rapidly. 	 ↓ or ↓
③	When jog switch is pressed, the threshold value is confirmed. 	

Output operation setting

Step	Description	Display
①	Press MODE key to light up MODE indicator / L/D ON (yellow). 	 Displays present setting
②	For FX-305(P) , select either Output 1 "Out 1" or Output 2 "Out 2" beforehand, if the jog switch is turned to the "+" or "-" direction, the output operation setting will change. 	 ↑ Dark state
③	When jog switch is pressed, the threshold value is confirmed. 	 Displays selected setting

Timer operation setting

- The setting for whether the timer is used or not can be done when MODE indicator / TIMER (yellow) lights up. For **FX-301B/G/H**, the timer type can be set in PRO mode.
- Further, an OFF-delay (initial value) which is useful when the response of the connected device is slow, etc., an ON-delay which is useful to detect only objects taking a long time to travel, and ONE SHOT, which is useful when the input specifications of the connected device require a signal of a fixed width, are possible with the **FX-301(-HS)**. **FX-305(P)** is also equipped with ON-delay • OFF-delay and ON-delay • ONE SHOT timers. Refer to the "PRO Mode Operation Guide" for the setting method of the OFF-delay, ON-delay and ONE SHOT timer intervals.

- FIBER SENSORS
- LASER SENSORS
- PHOTO-ELECTRIC SENSORS
- MICRO PHOTO-ELECTRIC SENSORS
- AREA SENSORS
- LIGHT CURTAINS
- PRESSURE / FLOW SENSORS
- INDUCTIVE PROXIMITY SENSORS
- PARTICULAR USE SENSORS
- SENSOR OPTIONS
- SIMPLE WIRE-SAVING UNITS
- WIRE-SAVING SYSTEMS
- MEASUREMENT SENSORS
- STATIC CONTROL DEVICES
- ENDOSCOPE
- LASER MARKERS
- PLC / TERMINALS
- HUMAN MACHINE INTERFACES
- ENERGY CONSUMPTION VISUALIZATION COMPONENTS
- FA COMPONENTS
- MACHINE VISION SYSTEMS
- UV CURING SYSTEMS
- Selection Guide
- Fibers
- Amplifiers
- FX-500
- FX-100
- FX-300
- FX-410
- FX-311
- FX-301-F7/ FX-301-F

PRECAUTIONS FOR PROPER USE

Refer to General precautions, p.80~ for fiber precautions, and to the "PRO mode operation guide" on our website for details pertaining to operating instructions for the amplifier.

Wiring

- Make sure that the power supply is off while wiring.
- Verify that the supply voltage variation is within the rating.
- Take care that if a voltage exceeding the rated range is applied, or if an AC power supply is directly connected, the product may get burnt or damaged.
- If power is supplied from a commercial switching regulator, ensure that the frame ground (F.G.) terminal of the power supply is connected to an actual ground.
- In case noise generating equipment (switching regulator, inverter motor, etc.) is used in the vicinity of this product, connect the frame ground (F.G.) terminal of the equipment to an actual ground.
- Take care that short circuit of the load wrong wiring may burn or damage the product.
- Do not run the wires together with high-voltage lines or power lines or put them in the same raceway. This can cause malfunction due to induction.
- Make sure to use an isolation transformer for the DC power supply. If an autotransformer (single winding transformer) is used, this product or the power supply may get damaged.
- Make sure to use the optional quick-connection cable for the connection of the amplifier. Extension up to total 100 m **328.084 ft** is possible with 0.3 mm², or more, cable. (5-8 unit expansion: 50 m **164.042 ft**, 9-16 unit expansion: 20 m **65.617 ft**) However, in order to reduce noise, make the wiring as short as possible.
- Note that the residual voltage will increase when the cable is extended.

Key-lock function

- If jog switch and MODE key are pressed for more than 2 sec. at the same time in 'RUN' mode condition, the key operations are locked, and only the threshold value confirmation function or the adjust function (valid only when the adjust lock function is canceled) is valid. To cancel the lock function, press both the keys for more than 2 sec. once again.
Note: 3 seconds or more for **FX-301B/G/H(P)**.

Others

- When the emission halt of the light emitting amount selection function is set from "OFF" to "ON", the output may be unstable. Do not use the output control for 0.5 sec. after starting emission.
- Do not use during the initial transient time (0.5 sec.) after the power supply is switched on.
- Take care that the sensor is not directly exposed to fluorescent lamp from a rapid-starter lamp, a high frequency lighting device or sunlight etc. , as it may affect the sensing performance.
- Do not use this sensor in places having excessive vapor, dust, etc., or where it may come in contact with corrosive gas.
- Take care that the product does not come in direct contact with water, oil, grease, or organic solvents, such as, thinner, etc.
- This sensor cannot be used in an environment containing inflammable or explosive gases.
- Never disassemble or modify the sensor.

Function table for FX-300 series

	Previous models			New models		
	Standard type	High-function type	High-speed type	Standard type	High-speed type	High-function type
	FX-301(P) (Previous version unit)	FX-302(P)	FX-303(P)	FX-301(P) (Updated version unit)	FX-301(P)-HS	FX-305(P)
Four-chemical emitting element + APC circuit	No	No	No	Yes	Yes	Yes
Four-chemical emitting element only	Yes (Note)	Yes	Yes	————	————	————
Light emitting amount selection function	No	No	No	Yes	Yes	Yes
Reduced intensity mode (S-D)	Yes (Note)	Yes	No	Yes	Yes	————
9,999 digit display	No	No	No	No	No	Yes
Response time (Max. speed)	150 μs	300 μs	90 μs	65 μs	35 μs	65 μs
Interference prevention function (Effective no. of units)	Incorporated (4)	Incorporated (8)	Not incorporated (0)	Incorporated (4)	Not incorporated (0)	Incorporated (16)
Independent 2 outputs	No	No	No	No	No	Yes
Alarm output function	No	No	No	No	No	Yes
Error output function	No	No	No	No	No	Yes
Differential sensing	No	No	No	No	No	Yes
Window comparator mode	No	Yes	No	No	No	Yes

Peripheral units that can be combined

	Standard type	High-function type	High-speed type	Standard type	High-speed type	High-function type
Bank selection unit FX-CH(-P)	Yes	Yes	No	No	No	No
External input unit FX-CH2(-P)	No	No	No	Yes	No	Yes
Upper communication unit SC-GU1-485	No	No	No	Yes	No	Yes

Note: Except **FX-301B/G/H**.

- FIBER SENSORS
- LASER SENSORS
- PHOTO-ELECTRIC SENSORS
- MICRO PHOTO-ELECTRIC SENSORS
- AREA SENSORS
- LIGHT CURTAINS
- PRESSURE / FLOW SENSORS
- INDUCTIVE PROXIMITY SENSORS
- PARTICULAR USE SENSORS
- SENSOR OPTIONS
- SIMPLE WIRE-SAVING UNITS
- WIRE-SAVING SYSTEMS
- MEASUREMENT SENSORS
- STATIC CONTROL DEVICES
- ENDOSCOPE
- LASER MARKERS
- PLC / TERMINALS
- HUMAN MACHINE INTERFACES
- ENERGY CONSUMPTION VISUALIZATION COMPONENTS
- FA COMPONENTS
- MACHINE VISION SYSTEMS
- UV CURING SYSTEMS

- Selection Guide
- Fibers
- Amplifiers
- FX-500**
- FX-100**
- FX-300**
- FX-410**
- FX-311**
- FX-301-F7/ FX-301-F**

- FIBER SENSORS
- LASER SENSORS
- PHOTO-ELECTRIC SENSORS
- MICRO PHOTO-ELECTRIC SENSORS
- AREA SENSORS
- LIGHT CURTAINS
- PRESSURE / FLOW SENSORS
- INDUCTIVE PROXIMITY SENSORS
- PARTICULAR USE SENSORS
- SENSOR OPTIONS
- SIMPLE WIRE-SAVING UNITS
- WIRE-SAVING SYSTEMS
- MEASUREMENT SENSORS
- STATIC CONTROL DEVICES
- ENDOSCOPE
- LASER MARKERS
- PLC / TERMINALS
- HUMAN MACHINE INTERFACES
- ENERGY CONSUMPTION VISUALIZATION COMPONENTS
- FA COMPONENTS
- MACHINE VISION SYSTEMS
- UV CURING SYSTEMS
- Selection Guide
- Fibers
- Amplifiers
- FX-500
- FX-100
- FX-300
- FX-410
- FX-311
- FX-301-F7/ FX-301-F

PRECAUTIONS FOR PROPER USE

Refer to General precautions, p.80~ for fiber precautions, and to the "PRO mode operation guide" on our website for details pertaining to operating instructions for the amplifier.

A difference between the updated version unit and the previous version unit for FX-301(P) (Red LED type)

- The product has been modified as shown below since its production in June 2004.

Changes in appearance

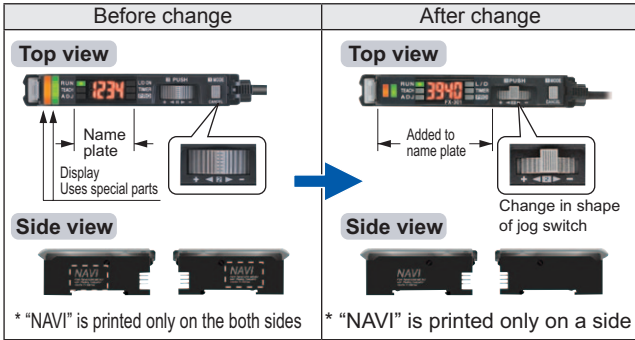

- Checking minor changes between previous and updated models can be done by checking whether the printing is on both sides or only one side.

Upgraded functions

1. Response times added

An ultra high-speed mode (H-SP) has been added to the existing 4 response time modes [high-speed (FAST), reduced intensity (S-D), standard (STD) and long range (LONG)].

This is changed using "Pro1" in "SPEd".

Before change	After change
<p>4 steps</p> <p>150 μs (FAST)</p> <p>250 μs (S-D)</p> <p>250 μs (STD)</p> <p>2 ms (LONG)</p>	<p>5 steps</p> <p>65 μs (added) (H-SP)</p> <p>150 μs (FAST)</p> <p>250 μs (S-D)</p> <p>250 μs (STD)</p> <p>2 ms (LONG)</p>

2. Extension of timer period

The setting range for the timer period was previously 500 ms, but this has been extended to a new range of 9,999 ms.

3. Light emitting amount selection function

The light emitting amount can be changed to one of 4 levels (5 levels when emission halt is included).

4. Backup, copy lock and key lock functions added

Backup: This selects whether or not threshold values set by teaching are written to (stored in) an EEPROM.

Copy lock: This selects whether copy function and data bank function communication are possible or not.

Key lock: This disables input using switches to prevent accidental changing of settings.

Changes in operation

1. Timer selection method

Previous version unit: Timer type was changed using PRO1 mode. The "TIMER" setting in NAVI mode could only be turned on or off.

After change: The type of timer can be changed using the "TIMER" function in NAVI mode.

2. Checking threshold value in RUN mode

The threshold values can be checked by turning the jog switch.

Display changes

1. Checking blinking of sensitivity surplus

The stable surplus display method after teaching has been changed.

Previous version unit: Sensitivity surplus is indicated by the number of blinks of the stability indicator.

After change Digital display only

2. Initial direct code value changed

The factory default settings for the direct codes have been changed.

Previous version unit 0000 → After change 0004

* The default setting for the timer period is 10 ms, and the direct code for 10 ms is "4", so this has been changed.

Internal circuit changes

1. Addition of an APC circuit

A four-chemical emitting element which provides stable sensing over long periods has been added, as well as an APC (Auto Power Control) circuit that improves stability during short periods.

Cautions on sensor connection in cascade

When connecting the previous version unit (including FX-301B/G/H) and updated version unit to be used in a cascade, refer to "Cautions on sensor connection in cascade".

PRECAUTIONS FOR PROPER USE

Refer to General precautions, p.80~ for fiber precautions, and to the “PRO mode operation guide” on our website for details pertaining to operating instructions for the amplifier.

Diagram of functions and settings

The amplifier features and settings are generally classified into two main modes; the “NAVI mode” for items and settings that are frequently reconfigured, and the “PRO mode” that contains more detailed settings.

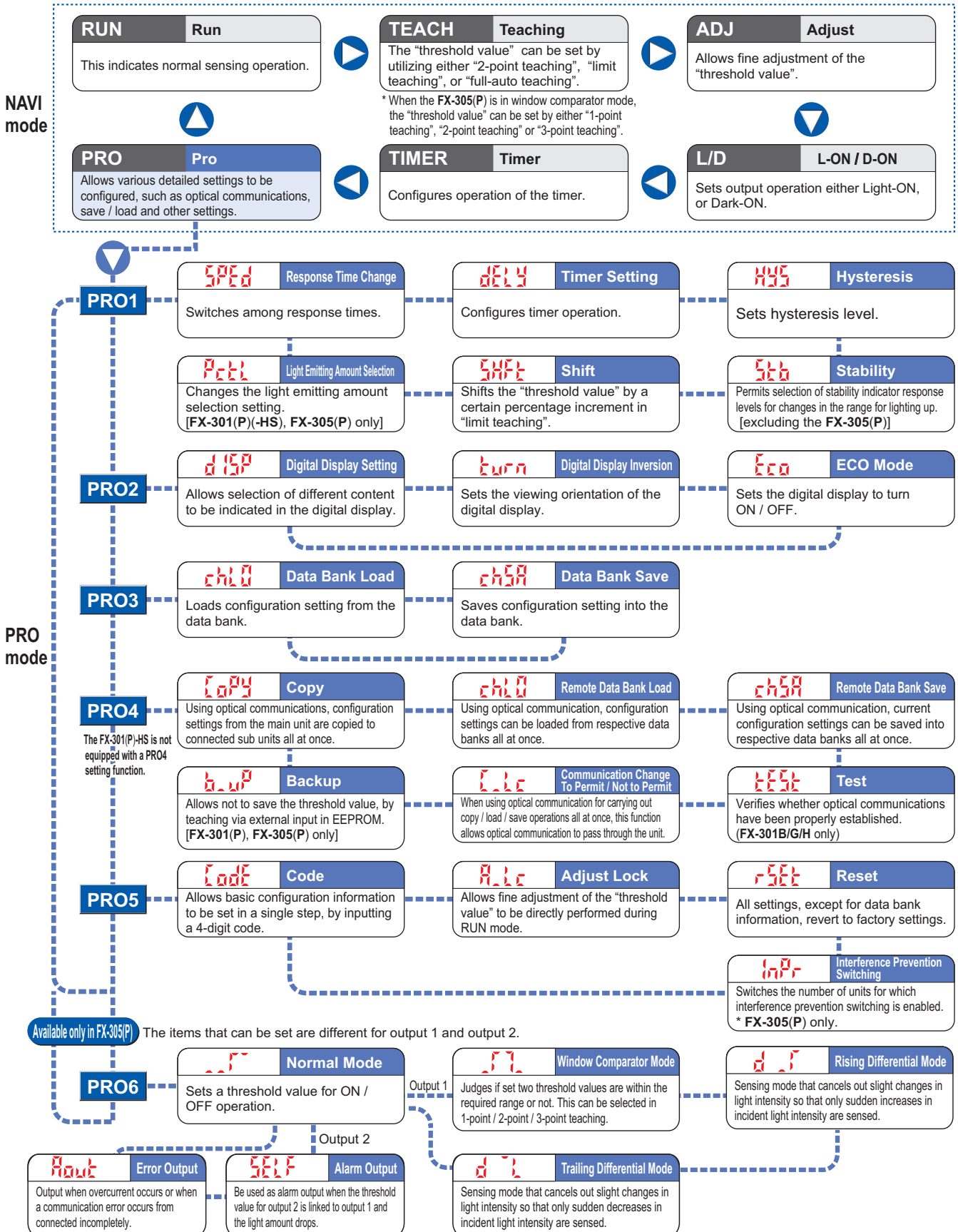

* The 0-ADJ setting function equipped on the **FX-301** and **FX-305(P)** has been deleted since the production in May 2005.

FIBER SENSORS

LASER SENSORS

PHOTO-ELECTRIC SENSORS

MICRO PHOTO-ELECTRIC SENSORS

AREA SENSORS

LIGHT CURTAINS

PRESSURE / FLOW SENSORS

INDUCTIVE PROXIMITY SENSORS

PARTICULAR USE SENSORS

SENSOR OPTIONS

SIMPLE WIRE-SAVING UNITS

WIRE-SAVING SYSTEMS

MEASUREMENT SENSORS

STATIC CONTROL DEVICES

ENDOSCOPE

LASER MARKERS

PLC / TERMINALS

HUMAN MACHINE INTERFACES

ENERGY CONSUMPTION VISUALIZATION COMPONENTS

FA COMPONENTS

MACHINE VISION SYSTEMS

UV CURING SYSTEMS

Selection Guide

Fibers

Amplifiers

FX-500

FX-100

FX-300

FX-410

FX-311

FX-301-F7/ FX-301-F

DIMENSIONS (Unit: mm in)

The CAD data in the dimensions can be downloaded from our website.

- FIBER SENSORS
- LASER SENSORS
- PHOTO-ELECTRIC SENSORS
- MICRO PHOTO-ELECTRIC SENSORS
- AREA SENSORS
- LIGHT CURTAINS
- PRESSURE / FLOW SENSORS
- INDUCTIVE PROXIMITY SENSORS
- PARTICULAR USE SENSORS
- SENSOR OPTIONS
- SIMPLE WIRE-SAVING UNITS
- WIRE-SAVING SYSTEMS
- MEASUREMENT SENSORS
- STATIC CONTROL DEVICES
- ENDOSCOPE
- LASER MARKERS
- PLC/ TERMINALS
- HUMAN MACHINE INTERFACES
- ENERGY CONSUMPTION VISUALIZATION COMPONENTS
- FA COMPONENTS
- MACHINE VISION SYSTEMS
- UV CURING SYSTEMS
- Selection Guide
- Fibers
- Amplifiers
- FX-500
- FX-100
- FX-300**
- FX-410
- FX-311
- FX-301-F7/ FX-301-F

FX-301□ FX-305(P) Amplifier

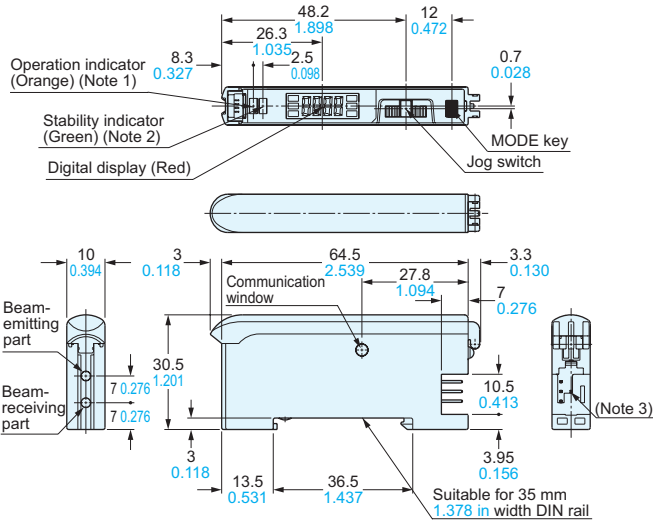

Notes: 1) **FX-305□**; Output 1 operation indicator (Orange)
 2) **FX-305□**; Output 2 operation indicator (Orange)
 3) **FX-301□**; 3-pin, **FX-305□**; 4-pin

CN-73-C□ CN-74-C□ Main cable (Optional)

• Length L

Model No.	Length L
CN-73/74-C1	1,000 39.370
CN-73/74-C2	2,000 78.740
CN-73/74-C5	5,000 196.850

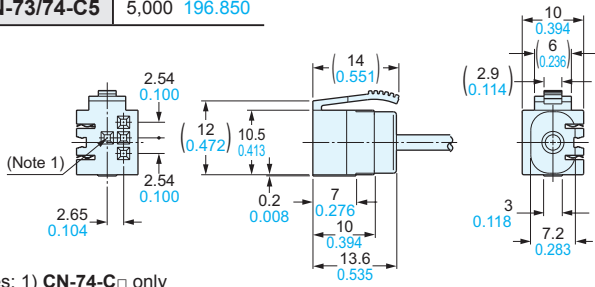

Notes: 1) **CN-74-C□** only
 2) **CN-73-C□**; 3-core

CN-71-C□ CN-72-C□ Sub cable (Optional)

• Length L

Model No.	Length L
CN-71/72-C1	1,000 39.370
CN-71/72-C2	2,000 78.740
CN-71/72-C5	5,000 196.850

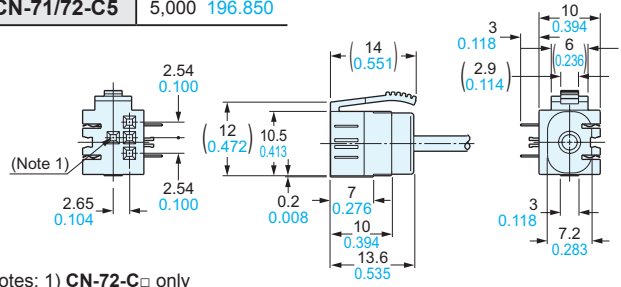

Notes: 1) **CN-72-C□** only
 2) **CN-71-C□**; 1-core

MS-DIN-2 Amplifier mounting bracket (Optional)

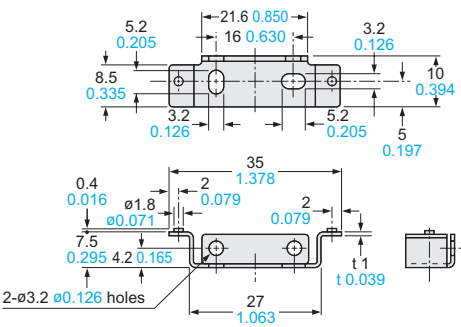

Material: Cold rolled carbon steel (SPCC)
 (Uni-chrome plated)

MS-DIN-E End plate (Optional)

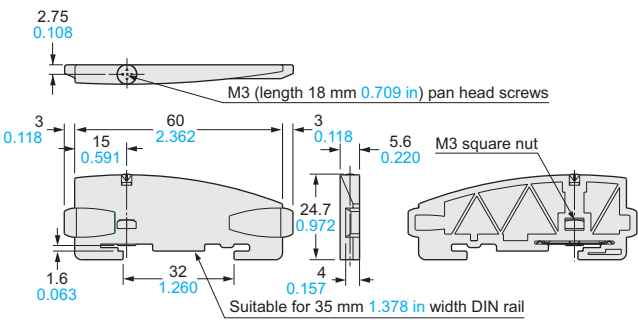

Material: Polycarbonate

MEMO

