

**3 GHz capable, 10 W carrying power (at 3 GHz), 50Ω/75Ω impedance and 1 Form C relays**

# RS RELAYS (ARS)

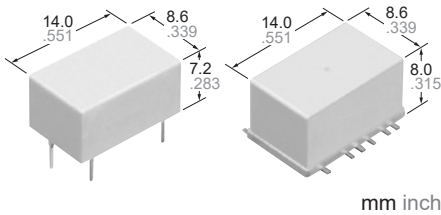

Protective construction: Sealed type

### FEATURES

- Miniature design**  
14×8.6×7.2 mm .551×.339×.283 inch (standard PC board terminal)

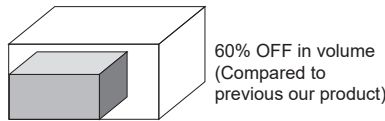

- Lineup includes quiet type. (75Ω type only)**  
Operation noise (Unit: dB)

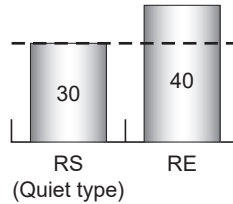

- Excellent high frequency characteristics**
- Lineup includes surface-mount terminal type**  
E and Y layouts available.

- Lineup includes reversed contact type**  
Great design freedom is possible using reversed contact type in which the positions of the N.O. and N.C. contacts are switched.

### TYPICAL APPLICATIONS

- Broadcasting and video equipment markets**
  - Broadcasting equipment
  - STB/tuner, etc.
- Mobile phone base stations**
- Communications market**
  - Antenna switching
  - All types of wireless devices
- Measurement equipment market**
  - Spectrum analyzer and oscilloscope, etc.

If you consider using applications with low level loads or with high frequency switching, please consult us.

### ORDERING INFORMATION

ARS					
RS relays					
Contact arrangement					
1: Standard contact type (1 Form C)					
3: Reversed contact type (1 Form C)					
Operating function					
0: Single side stable standard type (Impedance: 75Ω)					
1: 1 coil latching type (Impedance: 75Ω)					
2: 2 coil latching type (Impedance: 75Ω)					
3: Single side stable quiet type (Impedance: 75Ω)					
4: Single side stable type (Impedance: 50Ω)					
5: 1 coil latching type (Impedance: 50Ω)					
6: 2 coil latching type (Impedance: 50Ω)					
Nil: Standard PC board terminal					
A: Surface-mount terminal, E layout					
Y: Surface-mount terminal, Y layout					
Coil voltage, DC					
03: 3 V, 4H: 4.5 V, 09: 9 V, 12: 12 V, 24: 24 V (H=0.5)					
Packing style					
Nil: Carton packing (Standard PC board terminal only)					
Tube packing (Surface-mount terminal only)					
X: Tape and reel packing (picked from 2-pin side) (Surface-mount terminal only)					
Z: Tape and reel packing (picked from 18-pin side) (Surface-mount terminal only)					

## TYPES

## 1. Standard PC board terminal and standard contact type

Impedance	Rated voltage	Part No.			Standard packing	
		Single side stable type	1 coil latching type	2 coil latching type	Carton	Case
50 Ω	3 V DC	ARS1403	ARS1503	ARS1603	50 pcs.	500 pcs.
	4.5 V DC	ARS144H	ARS154H	ARS164H		
	9 V DC	ARS1409	ARS1509	ARS1609		
	12 V DC	ARS1412	ARS1512	ARS1612		
	V DC	ARS1424	ARS1524	ARS1624		

Impedance	Rated voltage	Part No.				Standard packing	
		Standard type			Quiet type	Carton	Case
		Single side stable type	1 coil latching type	2 coil latching type	Single side stable type		
75 Ω	3 V DC	ARS1003	ARS1103	ARS1203	ARS1303	50 pcs.	500 pcs.
	4.5 V DC	ARS104H	ARS114H	ARS124H	ARS134H		
	9 V DC	ARS1009	ARS1109	ARS1209	ARS1309		
	12 V DC	ARS1012	ARS1112	ARS1212	ARS1312		
	24 V DC	ARS1024	ARS1124	ARS1224	ARS1324		

## 2. Standard PC board terminal and reversed contact type

Impedance	Rated voltage	Part No.			Standard packing	
		Single side stable type	1 coil latching type	2 coil latching type	Carton	Case
50 Ω	3 V DC	ARS3403	ARS3503	ARS3603	50 pcs.	500 pcs.
	4.5 V DC	ARS344H	ARS354H	ARS364H		
	9 V DC	ARS3409	ARS3509	ARS3609		
	12 V DC	ARS3412	ARS3512	ARS3612		
	24 V DC	ARS3424	ARS3524	ARS3624		

Impedance	Rated voltage	Part No.				Standard packing	
		Standard type			Quiet type	Carton	Case
		Single side stable type	1 coil latching type	2 coil latching type	Single side stable type		
75 Ω	3 V DC	ARS3003	ARS3103	ARS3203	ARS3303	50 pcs.	500 pcs.
	4.5 V DC	ARS304H	ARS314H	ARS324H	ARS334H		
	9 V DC	ARS3009	ARS3109	ARS3209	ARS3309		
	12 V DC	ARS3012	ARS3112	ARS3212	ARS3312		
	24 V DC	ARS3024	ARS3124	ARS3224	ARS3324		

## 3. Surface-mount terminal and standard contact type, E layout

Impedance	Rated voltage	Part No.			Standard packing		
		Single side stable type	1 coil latching type	2 coil latching type	Tube	Tape and reel	Case
50 Ω	3 V DC	ARS14A03□	ARS15A03□	ARS16A03□	40 pcs.	500 pcs.	1,000 pcs.
	4.5 V DC	ARS14A4H□	ARS15A4H□	ARS16A4H□			
	9 V DC	ARS14A09□	ARS15A09□	ARS16A09□			
	12 V DC	ARS14A12□	ARS15A12□	ARS16A12□			
	24 V DC	ARS14A24□	ARS15A24□	ARS16A24□			
75 Ω	3 V DC	ARS10A03□	ARS11A03□	ARS12A03□			
	4.5 V DC	ARS10A4H□	ARS11A4H□	ARS12A4H□			
	9 V DC	ARS10A09□	ARS11A09□	ARS12A09□			
	12 V DC	ARS10A12□	ARS11A12□	ARS12A12□			
	24 V DC	ARS10A24□	ARS11A24□	ARS12A24□			

Note: The box at the end of a part number shows where packing type is indicated. If there is no indication, tube packing will be used.  
If "X" or "Z" is added, tape and reel packing will be used. Example: ARS14A03 (tube packing), ARS14A03X (tape and reel packing)

## 4. Surface-mount terminal and standard contact type, Y layout

Impedance	Rated voltage	Part No.			Standard packing		
		Single side stable type	1 coil latching type	2 coil latching type	Tube	Tape and reel	Case
50 Ω	3 V DC	ARS14Y03□	ARS15Y03□	ARS16Y03□	40 pcs.	500 pcs.	1,000 pcs.
	4.5 V DC	ARS14Y4H□	ARS15Y4H□	ARS16Y4H□			
	9 V DC	ARS14Y09□	ARS15Y09□	ARS16Y09□			
	12 V DC	ARS14Y12□	ARS15Y12□	ARS16Y12□			
	24 V DC	ARS14Y24□	ARS15Y24□	ARS16Y24□			
75 Ω	3 V DC	ARS10Y03□	ARS11Y03□	ARS12Y03□			
	4.5 V DC	ARS10Y4H□	ARS11Y4H□	ARS12Y4H□			
	9 V DC	ARS10Y09□	ARS11Y09□	ARS12Y09□			
	12 V DC	ARS10Y12□	ARS11Y12□	ARS12Y12□			
	24 V DC	ARS10Y24□	ARS11Y24□	ARS12Y24□			

Note: The box at the end of a part number shows where packing type is indicated. If there is no indication, tube packing will be used.  
If "X" or "Z" is added, tape and reel packing will be used. Example: ARS14Y03 (tube packing), ARS14Y03X (tape and reel packing)

## 5. Surface-mount terminal and reversed contact type, E layout

Impedance	Rated voltage	Part No.			Standard packing		
		Single side stable type	1 coil latching type	2 coil latching type	Tube	Tape and reel	Case
50 Ω	3 V DC	ARS34A03□	ARS35A03□	ARS36A03□	40 pcs.	500 pcs.	1,000 pcs.
	4.5 V DC	ARS34A4H□	ARS35A4H□	ARS36A4H□			
	9 V DC	ARS34A09□	ARS35A09□	ARS36A09□			
	12 V DC	ARS34A12□	ARS35A12□	ARS36A12□			
	24 V DC	ARS34A24□	ARS35A24□	ARS36A24□			
75 Ω	3 V DC	ARS30A03□	ARS31A03□	ARS32A03□			
	4.5 V DC	ARS30A4H□	ARS31A4H□	ARS32A4H□			
	9 V DC	ARS30A09□	ARS31A09□	ARS32A09□			
	12 V DC	ARS30A12□	ARS31A12□	ARS32A12□			
	24 V DC	ARS30A24□	ARS31A24□	ARS32A24□			

Note: The box at the end of a part number shows where packing type is indicated. If there is no indication, tube packing will be used.  
If "X" or "Z" is added, tape and reel packing will be used. Example: ARS34A03 (tube packing), ARS34A03X (tape and reel packing)

## 6. Surface-mount terminal and reversed contact type, Y layout

Impedance	Rated voltage	Part No.			Standard packing		
		Single side stable type	1 coil latching type	2 coil latching type	Tube	Tape and reel	Case
50 Ω	3 V DC	ARS34Y03□	ARS35Y03□	ARS36Y03□	40 pcs.	500 pcs.	1,000 pcs.
	4.5 V DC	ARS34Y4H□	ARS35Y4H□	ARS36Y4H□			
	9 V DC	ARS34Y09□	ARS35Y09□	ARS36Y09□			
	12 V DC	ARS34Y12□	ARS35Y12□	ARS36Y12□			
	24 V DC	ARS34Y24□	ARS35Y24□	ARS36Y24□			
75 Ω	3 V DC	ARS30Y03□	ARS31Y03□	ARS32Y03□			
	4.5 V DC	ARS30Y4H□	ARS31Y4H□	ARS32Y4H□			
	9 V DC	ARS30Y09□	ARS31Y09□	ARS32Y09□			
	12 V DC	ARS30Y12□	ARS31Y12□	ARS32Y12□			
	24 V DC	ARS30Y24□	ARS31Y24□	ARS32Y24□			

Note: The box at the end of a part number shows where packing type is indicated. If there is no indication, tube packing will be used.  
If "X" or "Z" is added, tape and reel packing will be used. Example: ARS34Y03 (tube packing), ARS34Y03X (tape and reel packing)

## RATING

### 1. Coil data

- Operating characteristics such as 'Operate voltage' and 'Release voltage' are influenced by mounting conditions, ambient temperature, etc. Therefore, please use the relay within  $\pm 5\%$  of rated coil voltage.
- 'Initial' means the condition of products at the time of delivery.

#### 1) Single side stable type

Rated voltage	Pick-up voltage* (at 20°C 68°F)	Drop-out voltage* (at 20°C 68°F)	Rated operating current [ $\pm 10\%$ ] (at 20°C 68°F)	Coil resistance [ $\pm 10\%$ ] (at 20°C 68°F)	Rated operating power	Max. allowable voltage
3 V DC	75%V or less of rated voltage (initial)	10%V or more of rated voltage (initial)	66.7 mA	45 Ω	200 mW	110%V (at 60°C 140°F) 150%V (at 20°C 68°F) or less of rated voltage
4.5 V DC			44.4 mA	101.3Ω		
9 V DC			22.2 mA	405 Ω		
12 V DC			16.7 mA	720 Ω		
24 V DC			8.3 mA	2,880 Ω		

\* Square, pulse drive (JIS C5442-1996)

#### 2) 1 coil latching type

Rated voltage	Set voltage* (at 20°C 68°F)	Reset voltage* (at 20°C 68°F)	Rated operating current [ $\pm 10\%$ ] (at 20°C 68°F)	Coil resistance [ $\pm 10\%$ ] (at 20°C 68°F)	Rated operating power	Max. allowable voltage
3 V DC	75%V or less of rated voltage (initial)	75%V or less of rated voltage (initial)	66.7 mA	45 Ω	200 mW	110%V (at 60°C 140°F) 150%V (at 20°C 68°F) or less of rated voltage
4.5 V DC			44.4 mA	101.3Ω		
9 V DC			22.2 mA	405 Ω		
12 V DC			16.7 mA	720 Ω		
24 V DC			8.3 mA	2,880 Ω		

\* Square, pulse drive (JIS C5442-1996)

#### 3) 2 coil latching type

Rated voltage	Set voltage* (at 20°C 68°F)	Reset voltage* (at 20°C 68°F)	Rated operating current [ $\pm 10\%$ ] (at 20°C 68°F)	Coil resistance [ $\pm 10\%$ ] (at 20°C 68°F)	Rated operating power	Max. allowable voltage
3 V DC	75%V or less of rated voltage (initial)	75%V or less of rated voltage (initial)	133.3 mA	22.5Ω	400 mW	110%V (at 60°C 140°F) 150%V (at 20°C 68°F) or less of rated voltage
4.5 V DC			88.9 mA	50.6Ω		
9 V DC			44.4 mA	202.5Ω		
12 V DC			33.3 mA	360 Ω		
24 V DC			16.7 mA	1,440 Ω		

\* Square, pulse drive (JIS C5442-1996)

## 2. Specifications

Item		Specifications	
Contact data	Arrangement	1 Form C	
	Contact resistance (initial)	Max. 100 mΩ (By voltage drop 10 V AC 10mA)	
	Contact material	Gold plating	
	Contact rating (resistive)	1W (at 3 GHz, Impedance: 50/75Ω, V.S.W.R.: Max. 1.4), 10 mA 24 V DC	
	Contact input power	Max. 10W (at 3GHz, Impedance: 50/75Ω, V.S.W.R.: Max. 1.4)	
	Max. switching voltage	30 V DC	
	Max. switching current	0.5 A DC	
High frequency characteristics, Impedance: 50Ω (initial)	V.S.W.R.	Max. 1.20/900MHz, Max. 1.40/3GHz (Standard PC board terminal) Max. 1.20/900MHz, Max. 1.40/3GHz (Surface-mount terminal)	
	Insertion loss (without D.U.T. board's loss)	Max. 0.10dB/900MHz, Max. 0.35dB/3GHz (Standard PC board terminal) Max. 0.20dB/900MHz, Max. 0.40dB/3GHz (Surface-mount terminal)	
	Isolation	Min. 60dB/900MHz, Min. 35dB/3GHz (Standard PC board terminal) Min. 55dB/900MHz, Min. 30dB/3GHz (Surface-mount terminal)	
High frequency characteristics, Impedance: 75Ω (initial)	V.S.W.R.	Max. 1.15/900MHz, Max. 1.40/3GHz (Standard PC board terminal) Max. 1.20/900MHz, Max. 1.50/3GHz (Surface-mount terminal)	
	Insertion loss (without D.U.T. board's loss)	Max. 0.10dB/900MHz, Max. 0.30dB/3GHz (Standard PC board terminal) Max. 0.20dB/900MHz, Max. 0.50dB/3GHz (Surface-mount terminal)	
	Isolation	Min. 60dB/900MHz, Min. 30dB/3GHz (Standard PC board terminal) Min. 55dB/900MHz, Min. 30dB/3GHz (Surface-mount terminal)	
Insulation resistance (initial)		Min. 100MΩ (at 500V DC, Measured portion is the same as the case of dielectric voltage.)	
Breakdown voltage (initial)	Between open contacts	500 Vrms for 1min. (detection current: 10mA)	
	Between contact and earth terminal	500 Vrms for 1min. (detection current: 10mA)	
	Between contact and coil	1,000 Vrms for 1min. (detection current: 10mA)	
Time characteristics	Operate [Set] time (initial)	Max. 10 ms [Max. 10 ms] (at 20°C 68°F, at rated voltage, without bounce)	
	Release [Reset] time (initial)	Max. 6 ms [Max. 10 ms] (at 20°C 68°F, at rated voltage, without bounce, without diode)	
Mechanical characteristics	Shock resistance	Functional	Min. 196 m/s <sup>2</sup> (half-sine shock pulse: 11 ms, detection time: 10μs)
		Destructive	Min. 980 m/s <sup>2</sup> (half-sine shock pulse: 6 ms)
	Vibration resistance	Functional	10 to 55 Hz at double amplitude of 3 mm (detection time: 10μs)
		Destructive	10 to 55 Hz at double amplitude of 5 mm
Operation noise* (initial)	Standard type	Approx. 40dB (at 20°C 68°F)	
	Quiet type (75Ω, PC board terminal type only)	Approx. 30dB (at 20°C 68°F)	
Expected life	Mechanical	Single side stable standard type	Min. 5×10 <sup>6</sup> (at 180 times/min.)
		Single side stable quiet type	Min. 10 <sup>6</sup> (at 180 times/min.)
		Latching type	Min. 10 <sup>6</sup> (at 180 times/min.)
	Electrical	50Ω type	Min. 10 <sup>6</sup> (Standard PC board terminal), Min. 3×10 <sup>5</sup> (Surface-mount terminal) (10V DC 10mA resistive)/Min. 3×10 <sup>5</sup> (24V DC 10mA resistive) Min. 10 <sup>6</sup> (Standard PC board terminal), Min. 3×10 <sup>5</sup> (Surface-mount terminal) (1W, at 3GHz, Impedance: 50Ω, V.S.W.R.: Max. 1.4) (at 20 times/min.)
		75Ω type	Min. 3×10 <sup>5</sup> (10mA 24V DC resistive) Min. 3×10 <sup>5</sup> (1W, at 3GHz, Impedance: 75Ω, V.S.W.R.: Max. 1.4) (at 20 times/min.)
Conditions	Conditions for operation, transport and storage	Ambient temperature: -40 to 70°C -40°F to 158°F (Single side stable standard and Latching type) Ambient temperature: -40 to 60°C -40°F to 140°F (Single side stable quiet type) Humidity: 5 to 85% R.H. (Not freezing and condensing at low temperature)	
Unit weight		Approx. 2 g .071 oz	

\* Measured the operation noise of the relay alone (with diodes at both ends of the coil) 30cm away from top side, by the A-weighted, FAST method while applying the rated voltage.

## REFERENCE DATA

1.-(1) High frequency characteristics (Impedance: 50Ω, Standard PC board terminal)

Sample: ARS144H; Measuring method: Measured with Agilent Technologies network analyzer (E8363B). \*For details, see "8. Measuring method" under "NOTES".

• V.S.W.R. characteristics

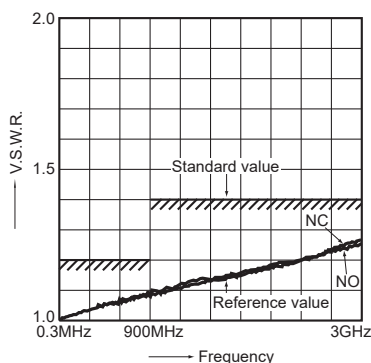

• Insertion loss characteristics (without D.U.T. board's loss)

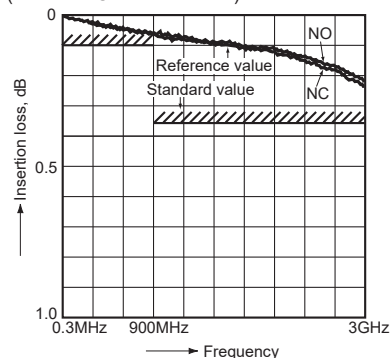

• Isolation characteristics

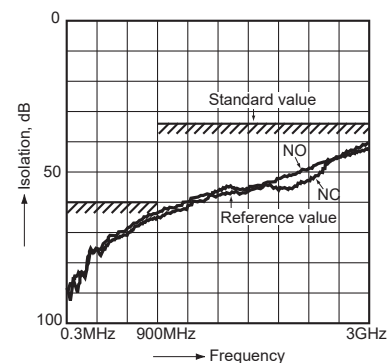

1.-(2) High frequency characteristics (Impedance: 75Ω, Standard PC board terminal)

Sample: ARS104H; Measuring method: Measured with Agilent Technologies network analyzer (E8363B). \*For details, see "8. Measuring method" under "NOTES".

• V.S.W.R. characteristics

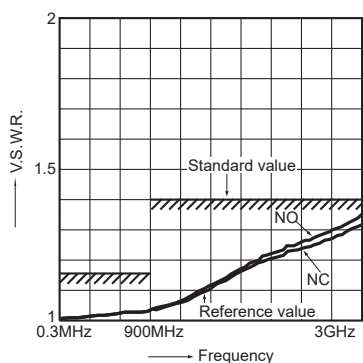

• Insertion loss characteristics (without D.U.T. board's loss)

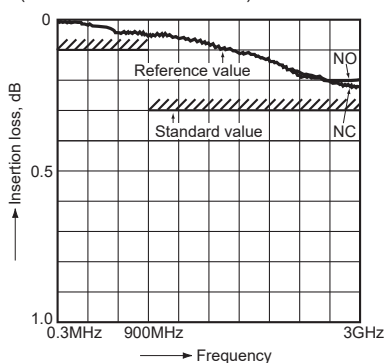

• Isolation characteristics

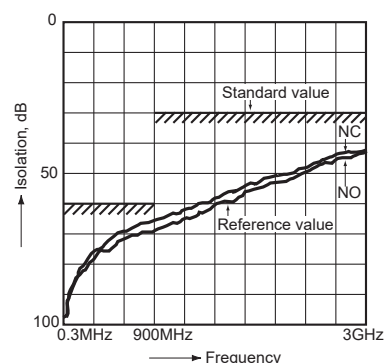

1.-(3) High frequency characteristics (Impedance: 50Ω, Surface-mount terminal)

Sample: ARS14A4H; Measuring method: Measured with Agilent Technologies network analyzer (E8363B). \*For details, see "8. Measuring method" under "NOTES".

• V.S.W.R. characteristics

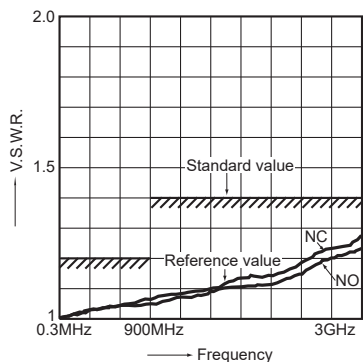

• Insertion loss characteristics (without D.U.T. board's loss)

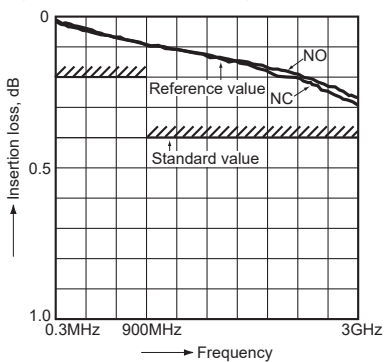

• Isolation characteristics

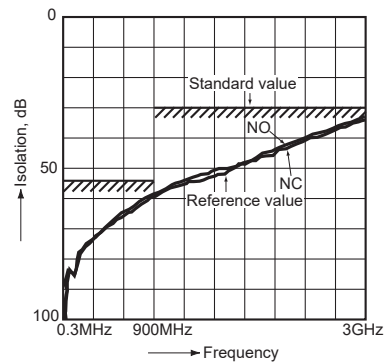

1.-(4) High frequency characteristics (Impedance: 75Ω, Surface-mount terminal)

Sample: ARS10A4H; Measuring method: Measured with Agilent Technologies network analyzer (E8363B). \*For details, see "8. Measuring method" under "NOTES".

• V.S.W.R. characteristics

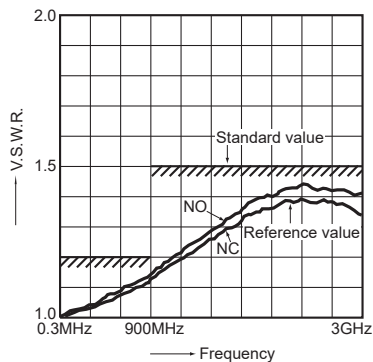

• Insertion loss characteristics (without D.U.T. board's loss)

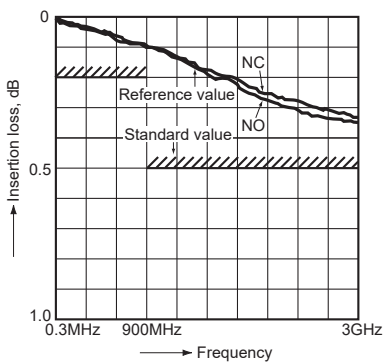

• Isolation characteristics

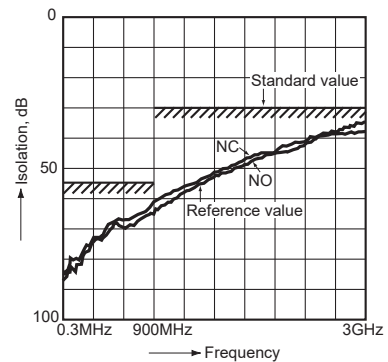

## 2.-(1) Operation noise distribution

Sample: ARS134H (single side stable quiet type), 50 pcs.  
 Coil voltage: rated voltage applied (with diode)  
 Equipment setting: A weighted sound pressure level, FAST.  
 Background noise: approx. 20 dB  
 Method of measurement: See figure below.

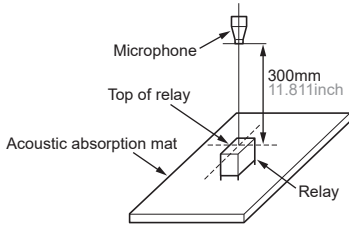

When operated

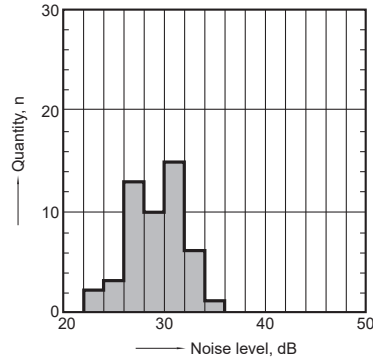

When released

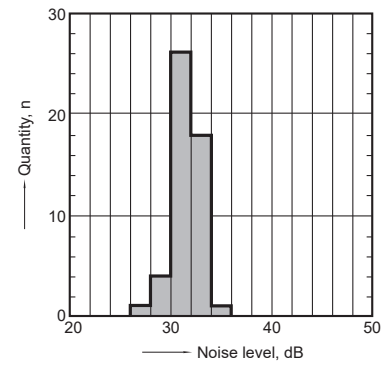

## 2.-(2) Operation noise distribution

Sample: ARS104H (single side stable standard type), 50 pcs.  
 Coil voltage: rated voltage applied (with diode)  
 Equipment setting: A weighted sound pressure level, FAST.  
 Background noise: approx. 20 dB  
 Method of measurement: See figure below.

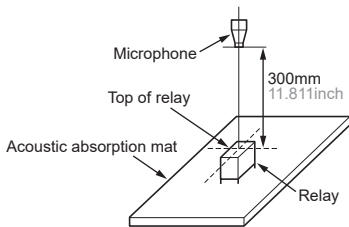

When operated

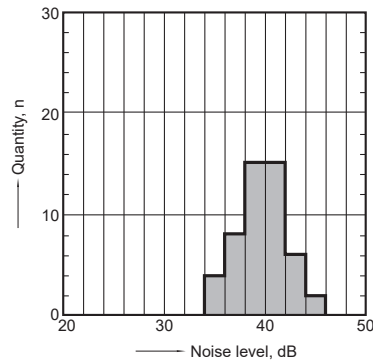

When released

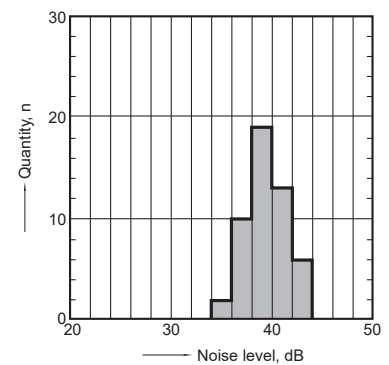

## 2.-(3) Operation noise distribution

Sample: ARS114H (latching type), 50 pcs.  
 Coil voltage: rated voltage applied (with diode)  
 Equipment setting: A weighted sound pressure level, FAST.  
 Background noise: approx. 20 dB  
 Method of measurement: See figure below.

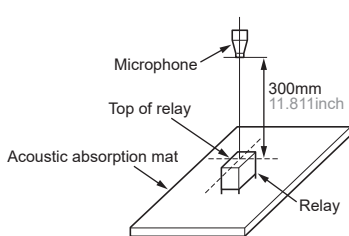

When set and reset

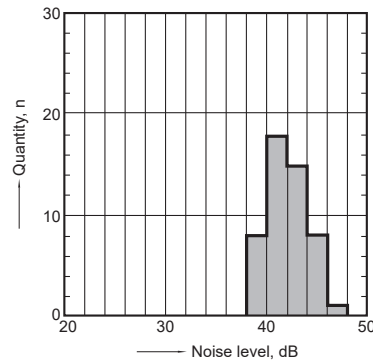

## DIMENSIONS (mm inch)

### <Standard PC board terminal>

#### 1. 50Ω type

**CAD Data**

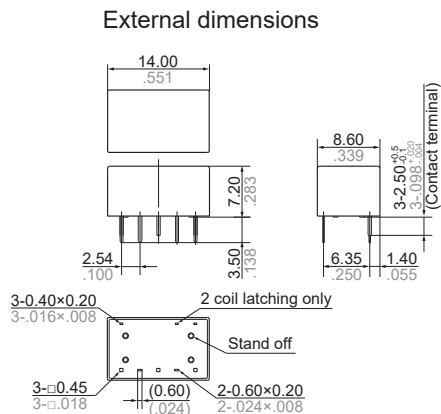
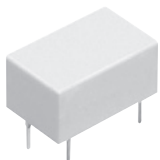

Tolerance:  $\pm 0.3 \pm 0.12$

### PC board pattern (Bottom view)

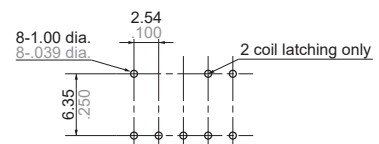

Tolerance:  $\pm 0.1 \pm 0.04$

The CAD data of the products with a **CAD Data** mark can be downloaded from <https://industrial.panasonic.com/ac/e/>

2. 75Ω type

CAD Data



External dimensions

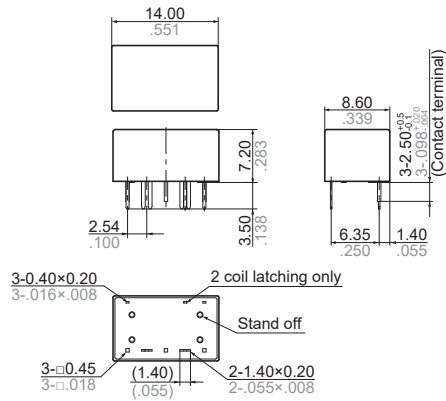

Tolerance:  $\pm 0.3 \pm .012$

PC board pattern (Bottom view)

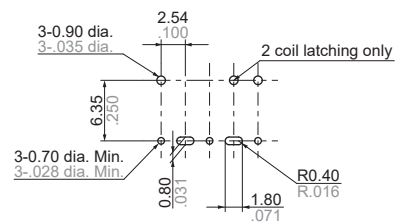

Tolerance:  $\pm 0.1 \pm .004$

Schematic (Bottom view)

<Standard contact type>

Single side stable type (Deenergized condition)

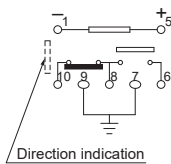

1 coil latching type (Reset condition)

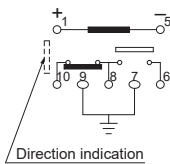

2 coil latching type (Reset condition)

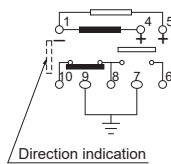

<Reversed contact type>

Single side stable type (Deenergized condition)

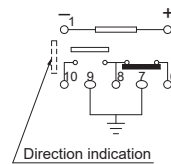

1 coil latching type (Reset condition)

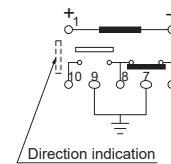

2 coil latching type (Reset condition)

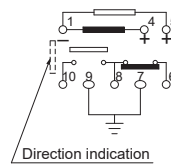

<Surface-mount terminal>

1. Impedance: 50Ω type

1) E layout



External dimensions

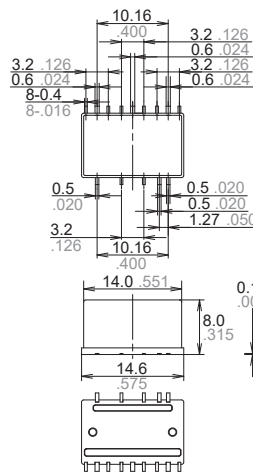

Tolerance:  $\pm 0.3 \pm .012$

PC board pattern (Top view)

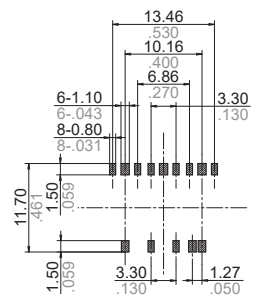

Tolerance:  $\pm 0.1 \pm .004$

Schematic (Top view)

<Standard contact type>

Single side stable type (Deenergized condition)

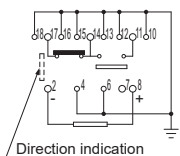

1 coil latching type (Reset condition)

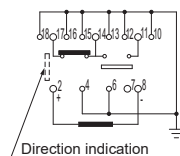

2 coil latching type (Reset condition)

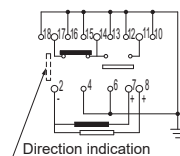

<Reversed contact type>

Single side stable type (Deenergized condition)

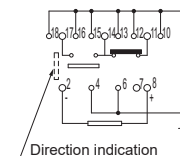

1 coil latching type (Reset condition)

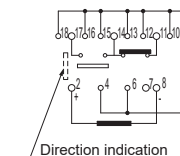

2 coil latching type (Reset condition)

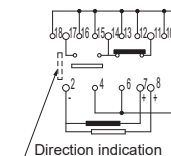

2) Y layout

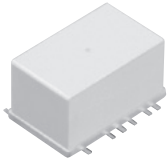

External dimensions

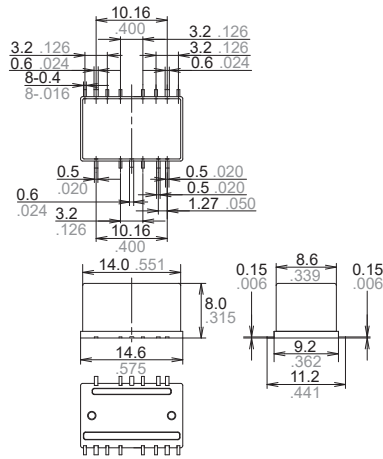

Tolerance:  $\pm 0.3 \pm 0.12$

PC board pattern (Top view)

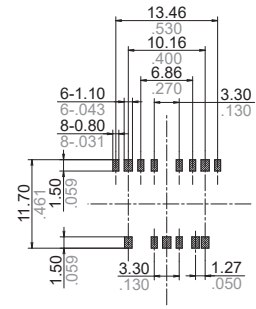

Tolerance:  $\pm 0.1 \pm 0.04$

Schematic (Top view)

<Standard contact type>

<Reversed contact type>

Single side stable type  
(Deenergized condition)

1 coil latching type  
(Reset condition)

2 coil latching type  
(Reset condition)

Single side stable type  
(Deenergized condition)

1 coil latching type  
(Reset condition)

2 coil latching type  
(Reset condition)

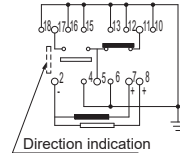
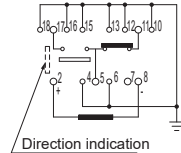
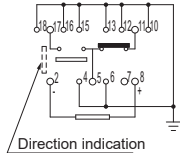
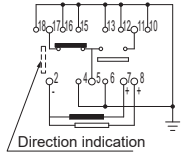
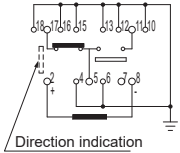
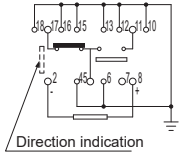

2. Impedance: 75Ω type

1) E layout

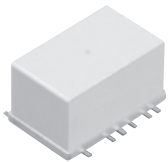

External dimensions

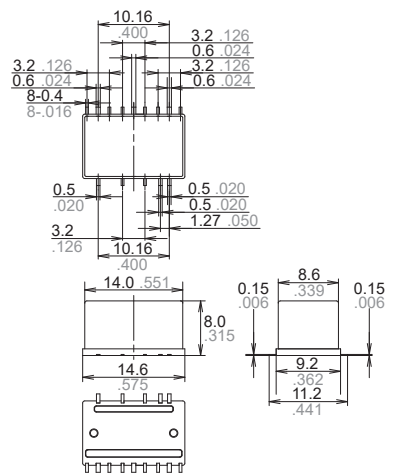

Tolerance:  $\pm 0.3 \pm 0.12$

PC board pattern (Top view)

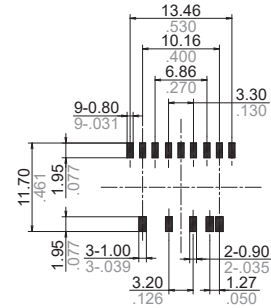

Tolerance:  $\pm 0.1 \pm 0.04$

Schematic (Top view)

<Standard contact type>

<Reversed contact type>

Single side stable type  
(Deenergized condition)

1 coil latching type  
(Reset condition)

2 coil latching type  
(Reset condition)

Single side stable type  
(Deenergized condition)

1 coil latching type  
(Reset condition)

2 coil latching type  
(Reset condition)

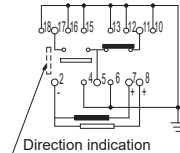
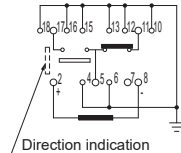
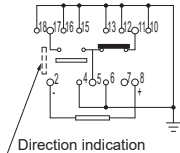
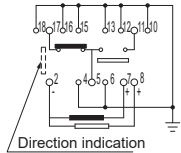
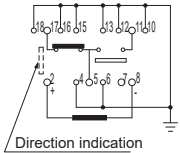
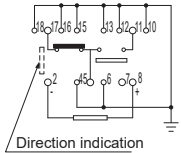



2) Y layout

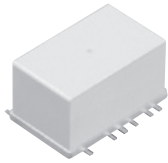

External dimensions

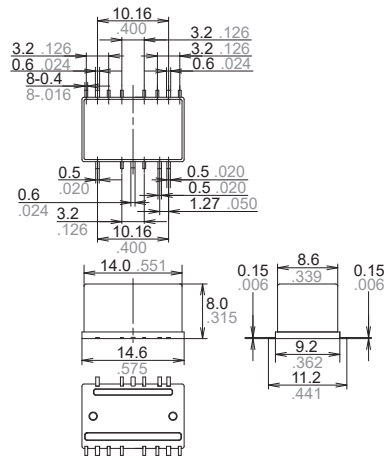

Tolerance:  $\pm 0.3 \pm .012$

PC board pattern (Top view)

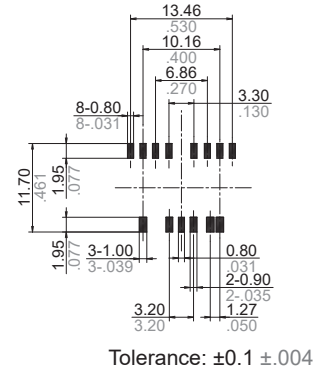

Tolerance:  $\pm 0.1 \pm .004$

Schematic (Top view)

<Standard contact type>

Single side stable type (Deenergized condition)

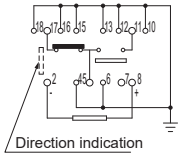

1 coil latching type (Reset condition)

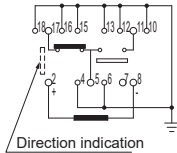

2 coil latching type (Reset condition)

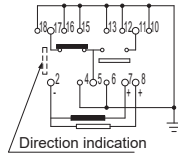

<Reversed contact type>

Single side stable type (Deenergized condition)

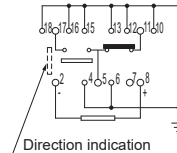

1 coil latching type (Reset condition)

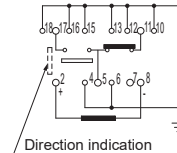

2 coil latching type (Reset condition)

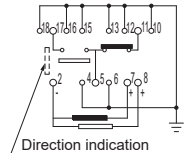

**NOTES**

**1. Coil operating power**

Pure DC current should be applied to the coil. The wave form should be rectangular. If it includes ripple, the ripple factor should be less than 5%.

However, check it with the actual circuit since the characteristics may be slightly different. The nominal operating voltage should be applied to the coil for more than 30 ms to set/reset the latching type relay.

**2. Coil connection**

When connecting coils, refer to the wiring diagram to prevent mis-operation or malfunction.

**3. External magnetic field**

Since RS relays are highly sensitive polarized relays, their characteristics will be affected by a strong external magnetic field. Avoid using the relay under that condition.

**4. Cleaning**

For automatic cleaning, the boiling method is recommended. Avoid ultrasonic cleaning which subjects the relays to high frequency vibrations, which may cause the contacts to stick. It is recommended that alcoholic solvents be used.

**5. Conditions for operation, transport and storage conditions**

1) Temperature

• Single side stable standard and latching type: -40 to 70°C -40 to 158°F

• Single side stable quiet type: -40 to 60°C -40 to 140°F

2) Humidity: 5 to 85% RH (Avoid freezing and condensation.)

The humidity range varies with the temperature. Use within the range indicated in the graph below.

3) Atmospheric pressure: 86 to 106 kPa

Temperature and humidity range for usage, transport, and storage:

Single side stable standard and latching type

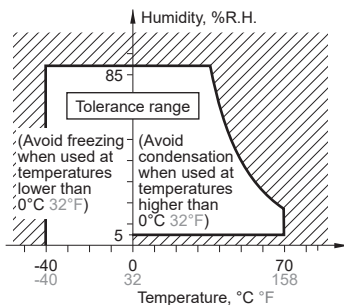

Single side stable quiet and latching type

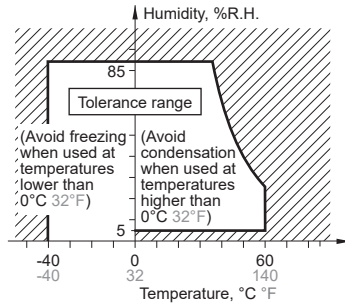

4) Condensation

Condensation forms when there is a sudden change in temperature under high temperature and high humidity conditions. Condensation will cause deterioration of the relay insulation.

5) Freezing

Condensation or other moisture may freeze on the relay when the temperature is lower than 0°C 32°F. This causes problems such as sticking of movable parts or operational time lags.

6) Low temperature, low humidity environments

The plastic becomes brittle if the relay is exposed to a low temperature, low humidity environment for long periods of time.

7) Storage requirements

Since the relay is sensitive to humidity, the surface-mount type is packaged with tightly sealed anti-humidity packaging. However, when storing, please be careful of the following.

(1) Please use promptly once the antihumidity pack is opened.

If relays are left as is after unpacking, they will absorb moisture which will result in loss of air tightness as a result of case expansion due to thermal stress when reflow soldering during the mounting process. (within one day, 30°C and 60%RH or less)

(2) When storing for a long period after opening the anti-humidity pack, storage in anti-humidity packaging with an antihumidity

bag to which silica gel has been added, is recommended.

\*Furthermore, if the relay is solder mounted when it has been subjected to excessive humidity, cracks and leaks can occur. Be sure to mount the relay under the required mounting conditions.

**6. Soldering**

1) Please meet the following conditions if this relay is to be automatically soldered.

(1) Preheating: Max. 120°C 248°F (terminal solder surface) for max. 120 seconds

(2) Soldering: Max. 260±5°C 500±9°F for max. 6 seconds

\*Relays are influenced by the type of PC board used. Please confirm with the actual PC board you plan to use.

\*Please avoid reflow soldering.

2) Surface-mount terminal

In case of automatic soldering, the following conditions should be observed

(1) Position of measuring temperature

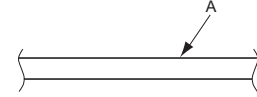

A: Surface of PC board where relay is mounted.

(2) IR (infrared reflow) soldering method

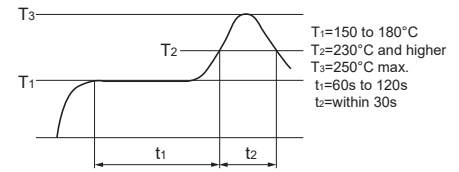

• Mounting cautions

Rise in relay temperature depends greatly on the component mix on a given PC board and the heating method of the reflow equipment. Therefore, please test beforehand using actual equipment to ensure that the temperature where the relay terminals are soldered and the temperature at the top of the relay case are within the conditions given above.

3) Please meet the following conditions if this relay is to be soldered by hand.

(1) 260°C 500°F for max. 10 seconds

(2) 350°C 662°F for max. 3 seconds

The effect on the relay depends on the actual substrate used. Please verify the substrate to be used.

(3) Avoid ultrasonic cleaning. Doing so will adversely affect relay characteristics. Please use alcohol-based cleaning solvents when cleaning relays.

**7. Tape and reel packing**

1) Tape dimensions

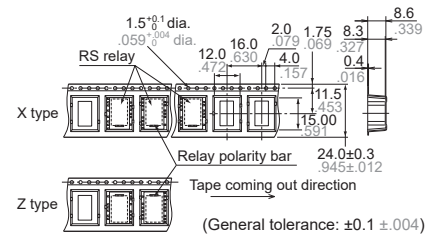

2) Dimensions of plastic reel

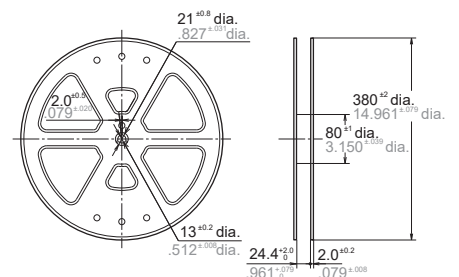

**8. Measuring method**

**1) 50Ω type**

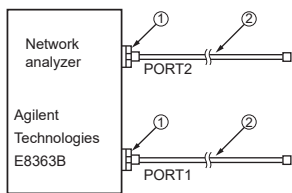

Connect connectors 1 and 2 respectively to PORT 1 and PORT 2. Perform calibration using the 3.5 mm calibration kit (HP85052B).

No.	Product name	Contents
1	Agilent 85130-60011	Adapter 2.4mm-3.5mm female .095inch-.138inch female
2	SUHNER SUCOFLEX104	Cable 3.5mm-3.5mm male .138inch-.138inch male

After calibration, connect the D.U.T. board and measure. However, connectors other than those for measurement should be connected with a 50Ω termination resistor.

**<Standard PC board terminal>**

PC board

Dimensions (mm inch)

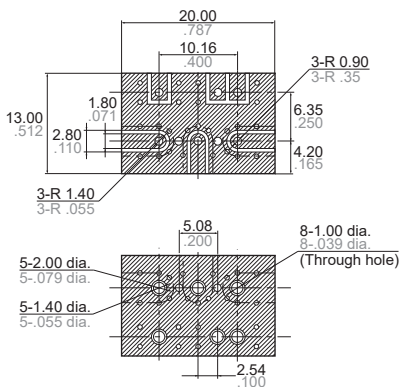

**<Surface-mount terminal and E layout>**

PC board

Dimensions (mm inch)

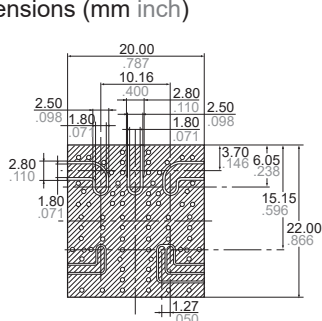

**<Surface-mount terminal and Y layout>**

PC board

Dimensions (mm inch)

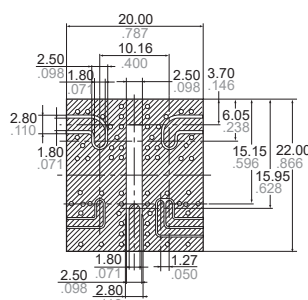

PC board for correction

Dimensions (mm inch)

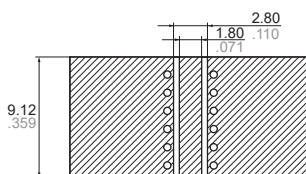

Material: Glass PTFE double-sided through hole PC board R-4737 (manufactured by our company)  
Board thickness: t = 0.8 mm .031 inch  
Copper plating: 18 μm  
Connector (SMA type)  
Product name: 01K1808-00 (Waka Manufacturing Co., Ltd.)

Insertion loss compensation:  
The insertion loss of relay itself is given by subtracting the insertion loss of shortcircuit the Com and the NC (or NO). (signal path and two connectors)

**2) 75Ω type**

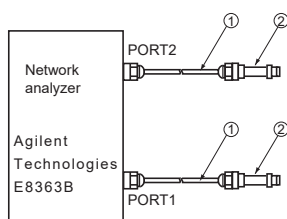

Connect connectors 1 and 2 respectively to PORT 1 and PORT 2. Perform calibration using the 3.5 mm calibration kit (HP85039B).

No.	Product name	Contents
1	85134-60003	Test port cable
2	11852B	Conversion adapter; 50Ω N type (female) to 75Ω N type (male)
2	85039-60011	Conversion adapter; 75Ω N type (female) to 75Ω F type (male)

After calibration, connect the D.U.T. board and measure. However, connectors other than those for measurement should be connected with a 75Ω termination resistor.

**<Standard PC board terminal>**

PC board

Dimensions (mm inch)

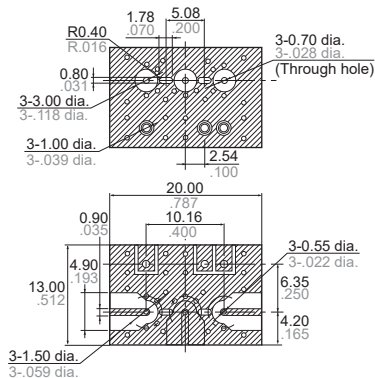

**<Surface-mount terminal and E layout>**

PC board

Dimensions (mm inch)

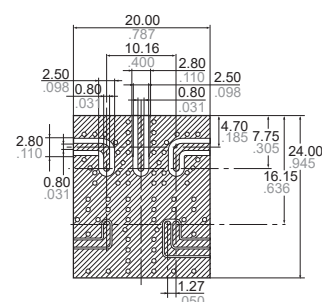

**<Surface-mount terminal and Y layout>**

PC board

Dimensions (mm inch)

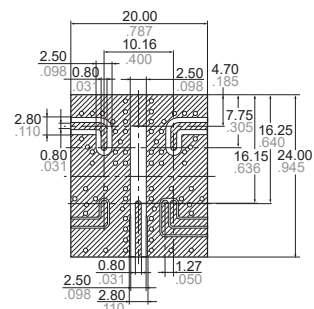

PC board for correction

Dimensions (mm inch)

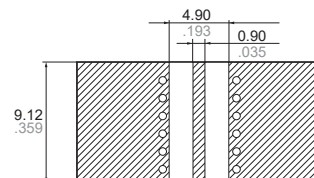

Material: Glass PTFE double-sided through hole PC board R-4737 (manufactured by our company)  
Board thickness: t = 0.8 mm .031 inch  
Copper plating: 18μm  
Connector (F type receptacle)  
Product name: C05-0236 (Komine Musen Electric Corporation)

## Insertion loss compensation:

The insertion loss of relay itself is given by subtracting the insertion loss of shortcircuit the COM and the NC (or NO). (signal path and two connectors)

### 9. Others

1) The switching lifetime is defined under the standard test condition specified in the JIS\* C 5442 standard (temperature 15 to 35°C 59 to 95°F, humidity 25 to 75%). Check this with the real device as it is affected by coil driving circuit, load type, activation frequency, activation phase, ambient conditions and other factors.

Also, be especially careful of loads such as those listed below.

- When used for AC load-operating and the operating phase is synchronous, rocking and fusing can easily occur due to contact shifting.

- When high-frequency opening and closing of the relay is performed with a load that causes arcs at the contacts, nitrogen and oxygen in the air is fused by the arc energy and  $\text{HNO}_3$  is formed. This can corrode metal materials.

Three countermeasures for these are listed here.

- (1) Incorporate an arc-extinguishing circuit.
  - (2) Lower the operating frequency
  - (3) Lower the ambient humidity
- 2) Use the relay within specifications such as coil rating, contact rating and on/off service life. If used beyond limits, the relay may overheat, generate smoke or catch fire.
- 3) Be careful not to drop the relay. If accidentally dropped, carefully check its appearance and characteristics before use.
- 4) Be careful to wire the relay correctly. Otherwise, malfunction, overheat, fire or other trouble may occur.
- 5) If a relay stays on in a circuit for many months or years at a time without being activated, circuit design should be reviewed so that the relay can remain non-excited. A coil that receives current all the time heats, which degrades insulation earlier than expected. A latching type relay is recommended for such circuits.

6) To ensure accurate operation of the latching type amidst surrounding temperature changes and other factors that might affect the set and reset pulse times, we recommend a coil impress set and reset pulse width of at least 30 ms at the rated operation voltage.

7) The latching type relay is shipped in the reset position. But jolts during transport or impacts during installation can change the reset position. It is, therefore, advisable to build a circuit in which the relay can be initialized (set and reset) just after turning on the power.

8) If silicone materials (e.g., silicone rubbers, silicone oils, silicone coating agents, silicone sealers) are used in the vicinity of the relay, the gas emitted from the silicone may adhere to the contacts of the relay during opening and closing and lead to improper contact. If this is the case, use a material other than silicone.

Please refer to **"the latest product specifications"** when designing your product.

- Requests to customers :

<https://industrial.panasonic.com/ac/e/salespolicies/>

# GUIDELINES FOR MICROWAVE DEVICES USAGE

For cautions for use, please read "GUIDELINES FOR RELAY USAGE".  
[https://industrial.panasonic.com/ac/e/control/relay/cautions\\_use/index.jsp](https://industrial.panasonic.com/ac/e/control/relay/cautions_use/index.jsp)

## Precautions for Coil Input

### ■ Long term current carrying

A circuit that will be carrying a current continuously for long periods without relay or microwave device switching operation. (circuits for emergency lamps, alarm devices and error inspection that, for example, revert only during malfunction and output warnings with form B contacts) Continuous, long-term current to the coil will facilitate deterioration of coil insulation and characteristics due to heating of the coil itself.

For circuits such as these, please use a magnetic-hold type latching relay. If you need to use a single stable relay, use a sealed type relay that is not easily affected by ambient conditions and make a failsafe circuit design that considers the possibility of contact failure or disconnection.

### ■ DC Coil operating power

Steady state DC current should be applied to the coil. The wave form should be rectangular. If it includes ripple, the ripple factor should be less than 5%.

However, please check with the actual circuit since the electrical characteristics may vary. The rated coil voltage should be applied to the coil and the set/reset pulse time of latching type relay differs for each relays, please refer to the relay's individual specifications.

### ■ Coil connection

When connecting coils of polarized relays, please check coil polarity (+,-) at the internal connection diagram (Schematic). If any wrong connection is made, it may cause unexpected malfunction, like abnormal heat, fire and so on, and circuit do not work. Avoid impressing voltages to the set coil and reset coil at the same time.

### ■ Maximum allowable voltage and temperature rise

Proper usage requires that the rated coil voltage be impressed on the coil. Note, however, that if a voltage greater than or equal to the maximum continuous voltage is impressed on the coil, the coil may burn or its layers short due to the temperature rise. Furthermore, do not exceed the usable ambient temperature range listed in the catalog.

#### ● Maximum allowable voltage for coil

In addition to being a requirement for relay operation stability, the maximum continuous impressed coil voltage is an important constraint for the prevention of such problems as thermal deterioration or deformity of the insulation material, or the occurrence of fire hazards.

## Ambient Environment

### ● Dew condensation

Condensation occurs when the ambient temperature drops suddenly from a high temperature and humidity, or the relay and microwave device is suddenly transferred from a low ambient temperature to a high temperature and humidity. Condensation causes the failures like insulation deterioration, wire disconnection and rust etc.

Panasonic Corporation does not guarantee the failures caused by condensation.

The heat conduction by the equipment may accelerate the cooling of device itself, and the condensation may occur.

Please conduct product evaluations in the worst condition of the actual usage. (Special attention should be paid when high temperature heating parts are close to the device. Also please consider the condensation may occur inside of the device.)

### ● Icing

Condensation or other moisture may freeze on relays when the temperature become lower than 0°C. This icing causes the sticking of movable portion, the operation delay and the contact conduction failure etc. Panasonic Corporation does not guarantee the failures caused by the icing.

The heat conduction by the equipment may accelerate the cooling of relay itself and the icing may occur. Please conduct product evaluations in the worst condition of the actual usage.

### ● Temperature rise due to pulse voltage

When a pulse voltage with ON time of less than 2 minutes is used, the coil temperature rise bears no relationship to the ON time. This varies with the ratio of ON time to OFF time, and compared with continuous current passage, it is rather small. The various relays are essentially the same in this respect.

Current passage time	(%)
For continuous passage	Temperature rise value is 100%
ON : OFF = 3 : 1	About 80%
ON : OFF = 1 : 1	About 50%
ON : OFF = 1 : 3	About 35%

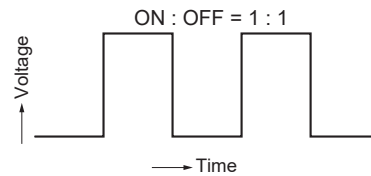

### ■ Operate voltage change due to coil temperature rise (Hot start)

In DC relays, after continuous passage of current in the coil, if the current is turned OFF, then immediately turned ON again, due to the temperature rise in the coil, the pick-up voltage will become somewhat higher. Also, it will be the same as using it in a higher temperature atmosphere. The resistance/temperature relationship for copper wire is about 0.4% for 1°C, and with this ratio the coil resistance increases. That is, in order to operate of the relay, it is necessary that the voltage be higher than the pick-up voltage and the pick-up voltage rises in accordance with the increase in the resistance value. However, for some polarized relays, this rate of change is considerably smaller.

### ● Low temperature and low humidity

The plastic becomes brittle if the switch is exposed to a low temperature, low humidity environment for long periods of time.

### ● High temperature and high humidity

Storage for extended periods of time (including transportation periods) at high temperature or high humidity levels or in atmospheres with organic gases or sulfide gases may cause a sulfide film or oxide film to form on the surfaces of the contacts and/or it may interfere with the functions. Check out the atmosphere in which the units are to be stored and transported.

### ● Package

In terms of the packing format used, make every effort to keep the effects of moisture, organic gases and sulfide gases to the absolute minimum.

# GUIDELINES FOR MICROWAVE DEVICES USAGE

## ●Storage requirements

Since the SMD type is sensitive to humidity it is packaged with tightly sealed anti-humidity packaging. However, when storing, please be careful of the following.

1) Please use promptly once the anti-humidity pack is opened. (within 72 hours, Max. 30°C/70% R.H.). If left with the pack open, the relay will absorb moisture which will cause thermal stress when reflow mounting and thus cause the case to expand. As a result, the seal may break.

\*For RE relays, after this bag is opened, the product must be used within 24 hours.

2) If relays will not be used within 72 hours, please store relays in a humidity controlled desiccator or in an anti-humidity bag to which silica gel has been added.

\*If the relay is to be soldered after it has been exposed to excessive humidity atmosphere, cracks and leaks can occur. Be sure to mount the relay under the required mounting conditions

\*For RE relays, after this bag is opened, the product must be used within 24 hours.

3) The following cautionary label is affixed to the anti-humidity pack.

## ●Silicon

When a source of silicone substances (silicone rubber, silicone oil, silicone coating materials and silicone filling materials etc.) is used around the relay, the silicone gas (low molecular siloxane etc.) may be produced.

This silicone gas may penetrate into the inside of the relay. When the relay is kept and used in this condition, silicone compound may adhere to the relay contacts which may cause the contact failure. Do not use any sources of silicone gas around the relay (Including plastic seal types).

## ●NOx Generation

When relay is used in an atmosphere high in humidity to switch a load which easily produces an arc, the NOx created by the arc and the water absorbed from outside the relay combine to produce nitric acid. This corrodes the internal metal parts and adversely affects operation. Avoid use at an ambient humidity of 85%RH or higher (at 20°C). If use at high humidity is unavoidable, please contact our sales representative.

\*RE Relays only

### **C a u t i o n**

This vacuum-sealed bag contains  
**Moisture Sensitive Products**

After this bag is opened, the product must be used

**within 7 2 h o u r s**

If product is not used within 72 hours, baking is necessary.

For baking conditions please contact us.

### **C a u t i o n**

This vacuum-sealed bag contains  
**Moisture Sensitive Products**

After this bag is opened, the product must be used

**within 2 4 h o u r s**

If product is not used within 24 hours, baking is necessary.

For baking conditions please contact us.

## Others

### ■Cleaning

1) Although the environmentally sealed type relay (plastic sealed type, etc.) can be cleaned, avoid immersing the relay into cold liquid (such as cleaning solvent) immediately after soldering. Doing so may deteriorate the sealing performance.

2) Surface mount terminal type relay is sealed type and it can be cleaned by immersion. Use pure water or alcohol-based cleaning solvent.

3) Cleaning with the boiling method is recommended (The temperature of cleaning liquid should be 40°C or lower).

Avoid ultrasonic cleaning on relays. Use of ultrasonic cleaning may cause breaks in the coil or slight sticking of the contacts due to the ultrasonic energy.

### ■Other handling precautions

• Expected switching life is defined under the standard test conditions (temperature 15 to 35°C, humidity: 25 to 75%) specified in JIS C 5442.

Expected switching life is depend on usage conditions; coil driving circuit, load type, activation frequency, activation phase, ambient conditions and other factors. Please check relays and microwave devices on the actual circuit.

Also, pay special attention loads such as those listed below.

• When used for AC load-operating and the operating phase is synchronous, rocking and fusing can easily occur due to contact shifting.

• Frequent switching under load condition

When high frequently switched under load condition that can cause arc at the contacts, nitrogen and oxygen in the air is fused by the arc energy and HNO<sup>3</sup> is formed. This can corrode metal materials. Countermeasures for these are.

1. Incorporate an arc-extinguishing circuit.
2. Lower the operating frequency
3. Lower the ambient humidity

• When used for "Dry switching" without load current, please contact our sales representative.

• Please avoid relays to be used outside of the specification ranges such as the coil rating, contact rating and switching life that may cause abnormal heating, smoke, and fire.

• In case relays and microwave devices are dropped, please do not use.

Please refer to "**the latest product specifications**" when designing your product.

•Requests to customers:

<https://industrial.panasonic.com/ac/e/salespolicies/>

---

Please contact .....

## Panasonic Corporation

Electromechanical Control Business Division

■1006, Oaza Kadoma, Kadoma-shi, Osaka 571-8506, Japan  
[industrial.panasonic.com/ac/e/](http://industrial.panasonic.com/ac/e/)

# Panasonic®

©Panasonic Corporation 2019