

*Rating is 6 GHz. Please refer to "REFERENCE DATA" regarding usage between 6 and 8 GHz.

New



Protective construction: Flux-resistant type

Compliance with RoHS Directive

FEATURES

1. 150 W carrying power possible (at 2GHz)
2. Excellent high frequency characteristics
Low insertion loss: Max. 0.12 dB (at 2GHz)
3. Miniature size and Surface mount (SMD) type

L: 9.6 × W: 14.6 × H: 10 mm

L: .378 × W: .575 × H: .394 inch

TYPICAL APPLICATIONS

- Base stations (Transmitter section)
Mobile phone, terrestrial digital, etc.
- Measuring equipment market
Spectrum analyzer and oscilloscope, etc.
- Other applications
High-frequency amp switching in wireless devices, etc.

If you wish to use in applications with low level loads or with high frequency switching, please consult us.

ORDERING INFORMATION

ARN A

Contact arrangement

- 1: 1 Form C standard contact type
3: 1 Form C reversed contact type (single side stable type only)

Operating function

- 0: Single side stable type
2: 2 coil latching type

Terminal shape

- A: Surface mount terminal

Coil voltage, DC*

4H: 4.5 V, 12: 12 V, 24: 24 V (H=0.5)

* For 28 V type, please consult us.

Packing style

Nil: Carton packing

X: Tape and reel packing (picked from 1 pin side)

Z: Tape and reel packing (picked from 13 pin side)

TYPES

1. Single side stable type

| Contact arrangement | Nominal coil voltage | Part No. | |
|---------------------|----------------------|-----------------------|-----------------------|
| | | Standard contact type | Reversed contact type |
| 1 Form C | 4.5 V DC | ARN10A4H | ARN30A4H |
| | 12 V DC | ARN10A12 | ARN30A12 |
| | 24 V DC | ARN10A24 | ARN30A24 |

Standard packing: 50 pcs. in an inner package (carton); 500 pcs. in an outer package

2. 2 coil latching type

| Contact arrangement | Nominal coil voltage | Part No. |
|---------------------|----------------------|-----------------------|
| | | Standard contact type |
| 1 Form C | 4.5 V DC | ARN12A4H |
| | 12 V DC | ARN12A12 |
| | 24 V DC | ARN12A24 |

Standard packing: 50 pcs. in an inner package (carton); 500 pcs. in an outer package

3. Single side stable type

| Contact arrangement | Nominal coil voltage | Part No. | |
|---------------------|----------------------|-----------------------|-----------------------|
| | | Standard contact type | Reversed contact type |
| 1 Form C | 4.5 V DC | ARN10A4H□ | ARN30A4H□ |
| | 12 V DC | ARN10A12□ | ARN30A12□ |
| | 24 V DC | ARN10A24□ | ARN30A24□ |

Standard packing: 400 pcs. in an inner package (tape and reel); 800 pcs. in an outer package

* Please add an X (picked from 1 pin side) or Z (picked from 13 pin side) at the end of the part number when ordering.

* Packing style symbol "X", "Z" is not marked on the relay.

RN (ARN)

4. 2 coil latching type

| Contact arrangement | Nominal coil voltage | Part No. |
|---------------------|----------------------|-----------------------|
| | | Standard contact type |
| 1 Form C | 4.5 V DC | ARN12A4H□ |
| | 12 V DC | ARN12A12□ |
| | 24 V DC | ARN12A24□ |

Standard packing: 400 pcs. in an inner package (tape and reel); 800 pcs. in an outer package

* Please add an X (picked from 1 pin side) or Z (picked from 13 pin side) at the end of the part number when ordering.

* Packing style symbol "X", "Z" is not marked on the relay.

RATING

1. Coil data

1) Single side stable type

| Nominal coil voltage | Pick-up voltage (at 20°C 68°F) | Drop-out voltage (at 20°C 68°F) | Nominal operating current [±10%] (at 20°C 68°F) | Coil resistance [±10%] (at 20°C 68°F) | Nominal operating power | Max. applied voltage (at 85°C 185°F) |
|----------------------|---|---|---|---------------------------------------|-------------------------|--------------------------------------|
| 4.5 V DC | 75%V or less of nominal voltage (Initial) | 10%V or more of nominal voltage (Initial) | 71.1 mA | 63.3Ω | 320 mW | 110%V of nominal voltage |
| 12 V DC | | | 26.7 mA | 450 Ω | | |
| 24 V DC | | | 13.3 mA | 1,800 Ω | | |

2) 2 coil latching type

| Nominal coil voltage | Set voltage (at 20°C 68°F) | Reset voltage (at 20°C 68°F) | Nominal operating current [±10%] (at 20°C 68°F) | Coil resistance [±10%] (at 20°C 68°F) | Nominal operating power | Max. applied voltage (at 85°C 185°F) |
|----------------------|---|---|---|---------------------------------------|-------------------------|--------------------------------------|
| 4.5 V DC | 75%V or less of nominal voltage (Initial) | 75%V or less of nominal voltage (Initial) | 88.9 mA | 50.6Ω | 400 mW | 110%V of nominal voltage |
| 12 V DC | | | 33.3 mA | 360 Ω | | |
| 24 V DC | | | 16.7 mA | 1,440 Ω | | |

2. Specifications

| Characteristics | Item | Specifications | |
|---|---|---|--|
| Contact | Arrangement | 1 Form C | |
| | Contact material | Gold plating | |
| | Contact resistance (Initial) | Max. 100 mΩ (By voltage drop 10 V AC 10mA) | |
| Rating | Nominal switching capacity | 80W (at 2 GHz, Impedance 50Ω, V.S.W.R. Max.1.15) | |
| | Contact carrying power (CW)*1 | Max.150W (at 20°C 68°F) (at 2 GHz, Impedance 50Ω, V.S.W.R. Max.1.15, with heat sink) Max.100W (at 20°C 68°F) (at 2 GHz, Impedance 50Ω, V.S.W.R. Max.1.15, without heat sink) | |
| | Nominal operating power | Single side stable type: 320 mW, 2 coil latching type: 400 mW | |
| High frequency characteristics (to 6 GHz) | V.S.W.R. (Max.) | to 1 GHz: 1.1, 1 to 2 GHz: 1.15, 2 to 3 GHz: 1.2, 3 to 6 GHz: 1.3 | |
| | Insertion loss (without D.U.T. board's loss, dB, Max.) | 0.1, 0.12, 0.15, 0.5 | |
| | Isolation (dB, Min.) | 60, 55, 45, 30 | |
| Electrical characteristics | Insulation resistance (Initial) | Min. 1,000 MΩ (at 500V DC, Measurement at same location as "Breakdown voltage" section.) | |
| | Breakdown voltage (Initial) | Between open contacts | 500 AC Vrms for 1min. (Detection current: 10mA) |
| | | Between contact and earth terminal | 500 AC Vrms for 1min. (Detection current: 10mA) |
| | | Between contact and coil | 500 AC Vrms for 1min. (Detection current: 10mA) |
| | Operate time [Set time] (at 20°C 68°F) | Max. 5 ms (Nominal voltage applied to the coil, excluding contact bounce time) | |
| Release time [Reset time] (at 20°C 68°F) | Single side stable type: Max. 5 ms (Nominal voltage applied to the coil, excluding contact bounce time)*2 2 coil latching type: Max. 5 ms (Nominal voltage applied to the coil, excluding contact bounce time) | | |
| Mechanical characteristics | Shock resistance | Functional | Min. 490 m/s ² (Half-wave pulse of sine wave: 11 ms, detection time: 10 μs) |
| | | Destructive | Min. 980 m/s ² (Half-wave pulse of sine wave: 6 ms) |
| | Vibration resistance | Functional | 10 to 55 Hz at double amplitude of 3 mm .118 inch (Detection time: 10 μs) |
| | | Destructive | 10 to 55 Hz at double amplitude of 5 mm .197 inch |
| Expected life | Mechanical life | Min. 1×10 ⁶ (at 180 cpm) | |
| | Electrical life (at 20 cpm) | <ul style="list-style-type: none"> • 1×10⁶ ope. at 10mA 10 VDC resistive load, • 1×10⁶ ope. at 1W High frequency load (at 2 GHz, Impedance 50Ω, V.S.W.R. Max.1.15), • 1×10³ ope. at 80 W High frequency load, operating frequency 5.0s ON, 5.0s OFF (at 2 GHz, Impedance 50Ω, V.S.W.R. Max.1.15, at 20°C 68°F, with heatsink) | |
| Conditions | Conditions for operation, transport and storage | Ambient temperature: -40 to +85°C -40 to +185°F, Humidity: 5 to 85% R.H. (Not freezing and condensing at low temperature) | |
| Unit weight | | Approx. 2.5 g .088 oz | |

Notes: *1. Since the design of the PC board and heat dispersion conditions affect contact carrying power, please verify under actual conditions.

*2. Release time will lengthen if a diode, etc., is connected in parallel to the coil. Be sure to verify operation under actual conditions.

REFERENCE DATA

1. High frequency characteristics

Sample: ARN10A12

Measuring method: Measured with Agilent Technologies network analyzer (E8363B).

* For details see "9. Measuring method of High frequency characteristics (Impedance 50Ω)" under "NOTES".

• V.S.W.R. characteristics

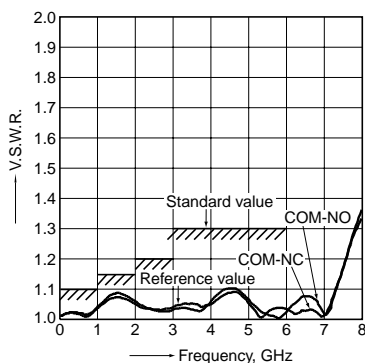

• Insertion loss characteristics (without D.U.T. board's loss)

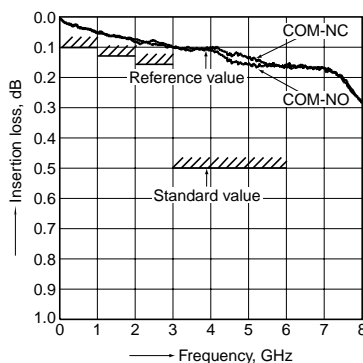

• Isolation characteristics

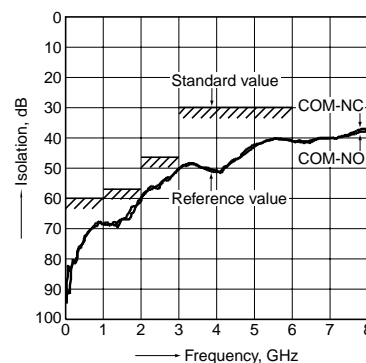

2. Contact carrying power (CW)

Max. 150 W (with heat sink) (at 2 GHz, Impedance 50Ω, V.S.W.R. Max. 1.15, at 20°C 68°F)

Max. 100 W (whithout heat sink) (at 2 GHz, Impedance 50Ω, V.S.W.R. Max. 1.15, at 20°C 68°F)

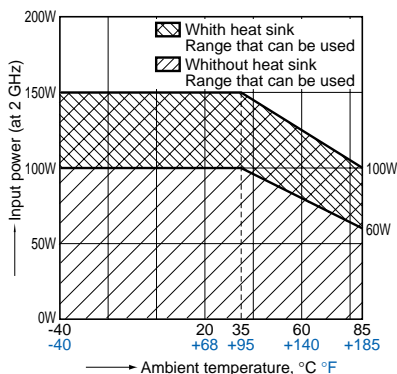

Measuring conditions:

Heat sink (AQP-HS-SJ20A) is used. (Reference: 2.9°C 37.22°F/W)

Heat sink (AQP-HS-SJ20A) (mm inch)



External dimensions

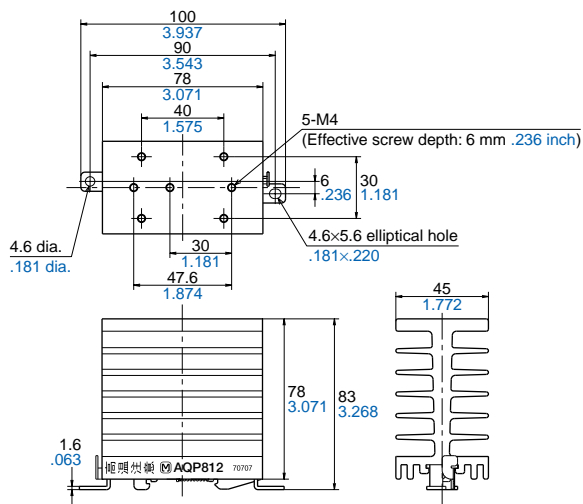

General tolerance: $\pm 0.1 \pm .004$

RN (ARN)

DIMENSIONS (mm inch)

The CAD data of the products with a **CAD Data** mark can be downloaded from: <http://panasonic-electric-works.net/ac>

CAD Data



External dimensions

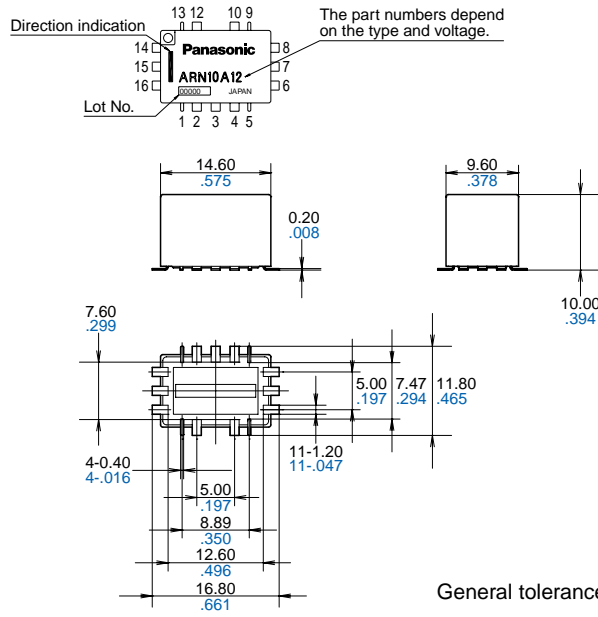

PC board pattern

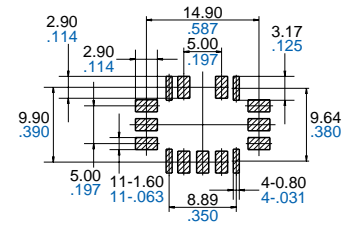

Schematic

Single side stable type/Standard contact type

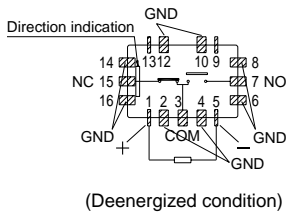

Single side stable type/Reversed contact type

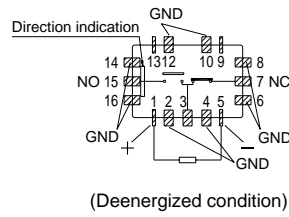

2 coil latching type/Standard contact type

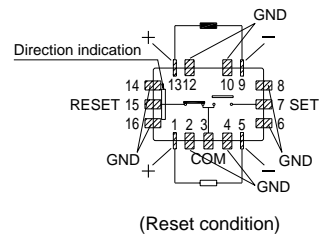

NOTES

1. Regarding cautions for use, please refer to “GENERAL APPLICATION GUIDELINES” on our general catalog.

2. Coil operating power

Pure DC current should be applied to the coil. If it includes ripple, the ripple factor should be less than 5%. However, check it with the actual circuit since the characteristics may be slightly different. The wave form of power should be rectangular. To ensure accurate operation, the voltage on both sides of the coil should be $\pm 5\%$ (at 20°C 68°F) of the nominal coil voltage. Also, please note that the pick-up and drop-out voltages (set and reset voltages) will change depending on operation temperature and conditions of use.

3. Coil connection

This relay is polarized relay, the coil voltage must be applied with correct polarity.

4. External magnetic field

Since RN relays are highly sensitive polarized relays, their characteristics will be affected by a strong external magnetic field. Avoid using the relay under that condition.

5. Cleaning

This product is not sealed type, therefore washing is not allowed.

6. Conditions for operation, transport and storage

- 1) Temperature: -40 to +85°C -40 to +185°F (But allowable temperature is from -40 to +60°C -40 to +140°F at our standard packing condition.)
 - 2) Humidity: 5 to 85% R.H. (Avoid freezing and condensation.) The humidity range varies with the temperature. Use within the range indicated in the graph below.
 - 3) Atmospheric pressure: 86 to 106 kPa
- Temperature and humidity range for usage, transport, and storage

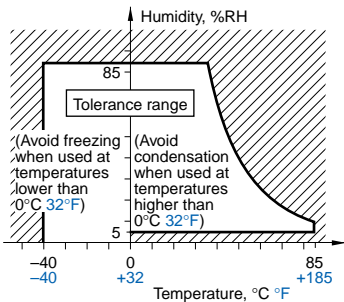

4) Condensation

Condensation forms when there is a sudden change in temperature under high temperature and high humidity conditions. Condensation will cause deterioration of the relay insulation.

5) Freezing

Condensation or other moisture may freeze on the relay when the temperature is lower than 0°C 32°F. This causes problems such as sticking of movable parts or operational time lags.

6) Low temperature and low humidity environments

The plastic becomes brittle if the relay is exposed to a low temperature, low humidity environment for long periods of time.

7) Storage requirements

Since the relay is sensitive to humidity, it comes in sealed anti-humidity packaging. However, when storing, please be careful of the following.

- (1) Please use promptly once the anti-humidity pack is opened.
- (2) When storing for a long period after opening the anti-humidity

pack, storage in anti-humidity packaging with an antihumidity bag to which silica gel has been added, is recommended.

*Furthermore, if the relay is solder mounted when it has been subjected to excessive humidity, cracks and leaks can occur. Be sure to mount the relay under the required mounting conditions.

7. Soldering

Please meet the following conditions if this relay is to be automatically soldered.

- 1) Position of measuring temperature

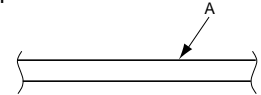

A: Surface of PC board where relay is mounted.

- 2) IR (infrared reflow) soldering method

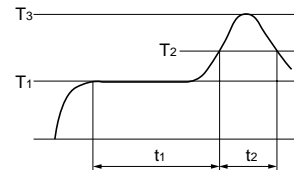

T₁ = 150 to 180°C 302 to 356°F t₁ = 60s to 120s
 T₂ = 230°C 446°F and higher t₂ = within 30s
 T₃ = 250°C 482°F max.

• Mounting cautions

Rise in relay temperature depends greatly on the component mix on a given PC board and the heating method of the reflow equipment. Therefore, please test beforehand using actual equipment to ensure that the temperature where the relay terminals are soldered and the temperature at the top of the relay case are within the conditions given above.

- 3) Please meet the following conditions if this relay is to be soldered by hand.

- (1) Max. 260°C 500°F (solder temperature), within 10 seconds (soldering time)
- (2) Max. 350°C 662°F (solder temperature), within 3 seconds (soldering time)

The effect on the relay depends on the actual PC board used. Please verify the PC board to be used.

8. Tape and reel packing

- 1) Tape dimensions (General tolerance: $\pm 0.1 \pm .004$)

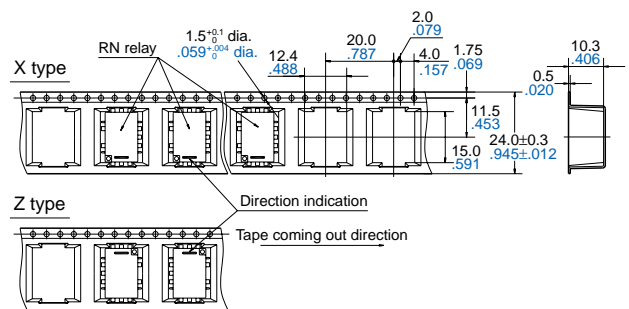

- 2) Dimensions of plastic reel

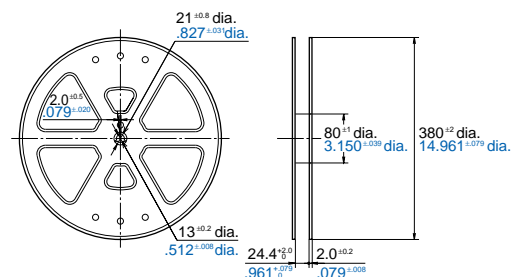

RN (ARN)

9. Measuring method of high frequency characteristics (Impedance 50Ω)

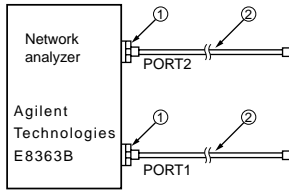

Connect connectors 1 and 2 respectively to PORT 1 and PORT 2. Perform calibration using the 3.5 mm calibration kit (HP85052B).

| No. | Product name | Contents |
|-----|------------------------|---|
| 1 | Agilent 85130-60011 | Adapter 2.4mm-3.5mm female .095inch-.138inch female |
| 2 | SUHNER SUCOFLEX104 | Cable 3.5mm-3.5mm male .138inch-.138inch male |

After calibration, connect the D.U.T. board and measure. However, connectors other than those for measurement should be connected with a 50Ω termination resistor.

D.U.T. board
Dimensions (mm inch)

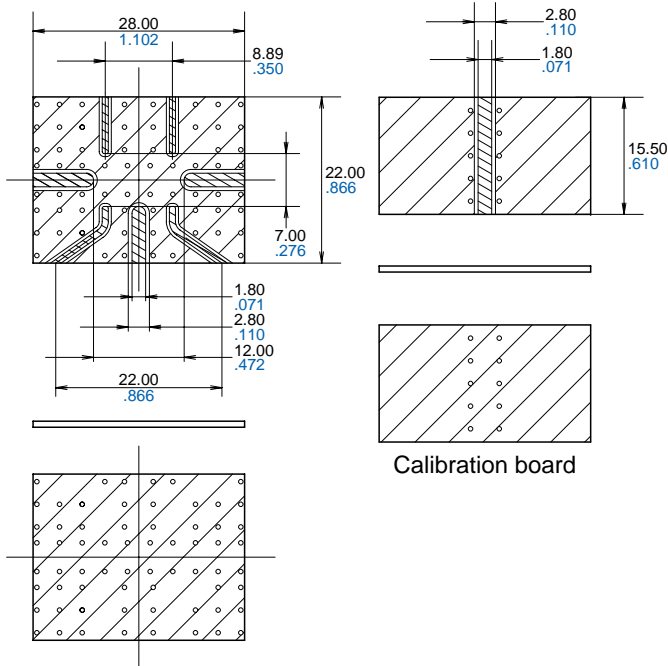

Material: Glass PTFE (double-sided, through hole PC board)
R-4737 (Panasonic Electric Works)
Board thickness: $t = 0.8 \text{ mm}$.031 inch
Copper plating thickness: 18 μm
Connector (SMA type)
Product name: 01K1808-00 (Waka Manufacturing Co., Ltd.)
Insertion loss compensation: The insertion loss of relay itself is given by subtracting the insertion loss of calibration board.

10. Others

- 1) The switching lifetime is defined under the standard test condition specified in the JIS* C 5442 standard (temperature 15 to 35°C 59 to 95°F, humidity 25 to 75%RH). Check this with the real device as it is affected by coil driving circuit, load type, activation frequency, activation phase, ambient conditions and other factors. *JIS: Japanese Industrial Standards
Also, be especially careful of loads such as those listed below.
 - When used for AC load-operating and the operating phase is synchronous, rocking and fusing can easily occur due to contact shifting.
 - When high-frequency opening and closing of the relay is performed with a load that causes arcs at the contacts, nitrogen and oxygen in the air is fused by the arc energy and HNO_3 is formed. This can corrode metal materials.
Three countermeasures for these are listed here.
 - (1) Incorporate an arc-extinguishing circuit.
 - (2) Lower the operating frequency
 - (3) Lower the ambient humidity

2) Use the relay within specifications such as coil rating, contact rating and on/off service life. If used beyond limits, the relay may overheat, generate smoke or catch fire.

3) Be careful not to drop the relay. If accidentally dropped, carefully check its appearance and characteristics before use.

4) Be careful to wire the relay correctly. Otherwise, malfunction, overheat, fire or other trouble may occur.

5) If a relay stays on in a circuit for many months or years at a time without being activated, circuit design should be reviewed so that the relay can remain non-excited. A coil that receives current all the time heats, which degrades insulation earlier than expected. A latching type relay is recommended for such circuits.

6) To ensure accurate operation of the latching type amidst surrounding temperature changes and other factors that might affect the set and reset pulse times, we recommend a coil impress set and reset pulse width of at least 30 ms at the rated operation voltage.

7) The latching type relay is shipped in the reset position. But jolts during transport or impacts during installation can change the reset position. It is, therefore, advisable to build a circuit in which the relay can be initialized (set and reset) just after turning on the power.

8) If silicone materials (e.g., silicone rubbers, silicone oils, silicone coating agents, silicone sealers) are used in the vicinity of the relay, the gas emitted from the silicone may adhere to the contacts of the relay during opening and closing and lead to improper contact. If this is the case, use a material other than silicone.

Panasonic Electric Works Co., Ltd.

Automation Controls Business Unit

■ Head Office: 1048, Kadoma, Kadoma-shi, Osaka 571-8686, Japan

■ Telephone: +81-6-6908-1050 ■ Facsimile: +81-6-6908-5781

panasonic-electric-works.net/ac

All Rights Reserved © 2011 COPYRIGHT Panasonic Electric Works

Specifications are subject to change without notice.

ASCTB71E 201109-2YT Printed in Japan.