

RMPA2550

2.4–2.5 GHz and 5.15–5.85 GHz Dual Band InGaP HBT Linear Power Amplifier

General Description

The RMPA2550 is a dual frequency band power amplifier designed for high performance WLAN applications in the 2.4-2.5 GHz and the 5.15-5.85 GHz frequency bands. The single low profile 20 pin 3 x 4 x 0.9 mm package with internal matching on both input and output to 50Ω minimizes next level PCB space and allows for simplified integration. The two on-chip detectors provide power sensing capability while the logic control provides power saving shutdown options. The PA's low power consumption and excellent linearity are achieved using our InGaP Heterojunction Bipolar Transistor (HBT) technology.

Features

- Dual band operation in a single package design
- 26 dB modulated gain 2.4 to 2.5 GHz band

- 27 dB modulated gain 5.15 to 5.85 GHz band
- 26 dBm output power @ 1 dB compression both frequency bands
- 2.0% EVM at 18 dBm modulated P_{OUT}, 2.45 GHz
- 2.3% EVM at 18 dBm modulated P_{OUT}, 5.45 GHz
- 3.3 V single positive supply operation
- Adjustable bias current operation
- Two power saving shutdown options (bias and logic control)
- Separate integrated power detectors with 20 dB dynamic range
- Low profile 20 pin, 3 x 4 x 0.9 mm standard QFN leadless package
- Internally matched to 50 ohms
- Optimized for use in 802.11a/b/g applications

Device



Electrical Characteristics^{1,3} 802.11g/a OFDM

Modulation (with 176 μs burst time, 100μs idle time) 54Mbps Data Rate, 16.7 MHz Bandwidth

Parameter	Minimum	Typical	Maximum	Minimum	Typical	Maximum	Unit
Frequency	2.4		2.5	5.15		5.85	GHz
Supply Voltage	3.0	3.3	3.6	3.0	3.3	3.6	V
Gain	24.5	26	28	25.5	27	29	dB
Total Current @ 18dBm P _{OUT}		150	182		228	260	mA
Total Current @ 19dBm P _{OUT}		157	189		235	267	mA
EVM @ 18dBm P _{OUT} ²		2.0	2.5		2.5	3.5	%
EVM @ 19dBm P _{OUT} ²		3.0	3.5		3.5	4.5	%
Detector Output @ 19dBm P _{OUT}		508	600		780	865	mV
Detector Threshold ⁴		5.0	7.0		5.0	7.0	dBm
P _{OUT} Spectral Mask Compliance ^{5,7}		21.0			21.0		dBm

Electrical Characteristics^{3,6} 802.11b CCK

Modulation (RF not framed) 11Mbps Data Rate, 22.0 MHz Bandwidth

Parameter	Minimum	Typical	Maximum	Unit
Frequency	2.4		2.5	GHz
Supply Voltage	3.0	3.3	3.6	V
Gain	24.5	26	28	dB
Total Current		250		mA
First Sidelobe Power			-40	dBc
Second Sidelobe Power			-55	dBc
Max P _{OUT} Spectral Mask Compliance ⁷		24.0		dBm

Notes:

- 1: VC1 2.4, VC2 2.4, VM 2.4, VC1 5.0, VC2 5.0, VC3 5.0, VM13 5.0, VM2 5.0 = 3.3 Volts, T=25°C, PA is constantly biased, 50Ω system. VL adjusted for either 2.4 or 5 GHz operation.
- 2: Percentage includes system noise floor of EVM=0.8%.
- 3: Not measured 100% in production.
- 4: P_{OUT} measured at P_{IN} corresponding to power detection threshold.
- 5: Measured at P_{IN} at which Spectral Mask Compliance is satisfied. Two-sample windowing length applied.
- 6: VC1 2.4, VC2 2.4, VM 2.4 = 3.3 Volts, T=25°C, P_{OUT} = +23 dBm, 50Ω system. Satisfies spectral mask.
- 7: P_{IN} is adjusted to point where performance approaches spectral mask requirements.

Electrical Characteristics¹ Single Tone

Parameter	Minimum	Typical	Maximum	Minimum	Typical	Maximum	Unit
Frequency	2.4		2.5	5.15		5.85	GHz
Supply Voltage	3.0	3.3	3.6	3.0	3.3	3.6	V
Gain ²	24	26	29	24	27.5	31	dB
Total Quiescent Current ²	70	120	150	150	180	225	mA
Bias Current at pin VM ³		13.5	18.0		15.5		mA
P1dB Compression ²	25	26		24	26		dBm
Current @ P1dB Comp ²		350	475		400	475	mA
Standby Current ⁴		0.5			2		mA
Shutdown Current (VM=0V)		<1.0			100		µA
Input Return Loss		15			14		dB
Output Return Loss		12			16		dB
Detector Output at P1dB Comp		2.0			3.0		V
Detector P _{OUT} Threshold ⁹		7.0	9.0		7.0	9.0	dBm
2 nd Harmonic Output at P1dB		-45			-30		dBc
3rd Harmonic Output at P1dB		-42			-35		dBc
Logic							
Shutdown Control Pin:		VL 2.4			VL 5.0		
Device Off	2.0	2.4			0.0	0.8	V
Device On		0.0	0.8	2.0	2.4		V
Logic Current		10			100		µA
Turn-on Time ⁵		<1			<1		µS
Turn-off Time		<1			<1		µS
Spurious (Stability) ⁶		-65			-65		dBc

Notes:

- 1: VC1 2.4 ,VC2 2.4, VM 2.4, VC1 5.0, VC2 5.0, VC3 5.0, VM13 5.0, VM2 5.0 = 3.3 Volts, T=25°C, PA is constantly biased, 50Ω system. VL adjusted for either 2.4 or 5 GHz operation.
- 2: 100% production screened.
- 3: Bias current is included in the Total Quiescent Current.
- 4: VL is set to Logic Level for Device Off operation.
- 5: Measured from Device On signal turn on, to the point where RF P_{OUT} stabilizes to 0.5dB.
- 6: Load VSWR is set to 8:1 and the angle is varied 360 degrees. P_{OUT} = -30dBm to P1dB.
- 7: No permanent damage with only one parameter set at extreme limit. Other parameters set to typical values.
- 8: Not measured in production.
- 9: P_{OUT} measured at P_{IN} corresponding to power detection threshold.

Absolute Ratings¹

Symbol	Parameter	Value	Units
VC	Positive Supply Voltage	5	V
IC2.4, IC5.0	Supply Current		
	IC2.4	820	mA
	IC5.0	700	mA
VM	Positive Bias Voltage	4.0	V
V _L	Logic Voltage	5	V
P _{IN}	RF Input Power	10	dBm
T _{CASE}	Case Operating Temperature	-40 to +85	°C
T _{STG}	Storage Temperature	-55 to +150	°C

Note:

1. No permanent damage with only one parameter set at extreme limit. Other parameters set to typical values.

Functional Block Diagram

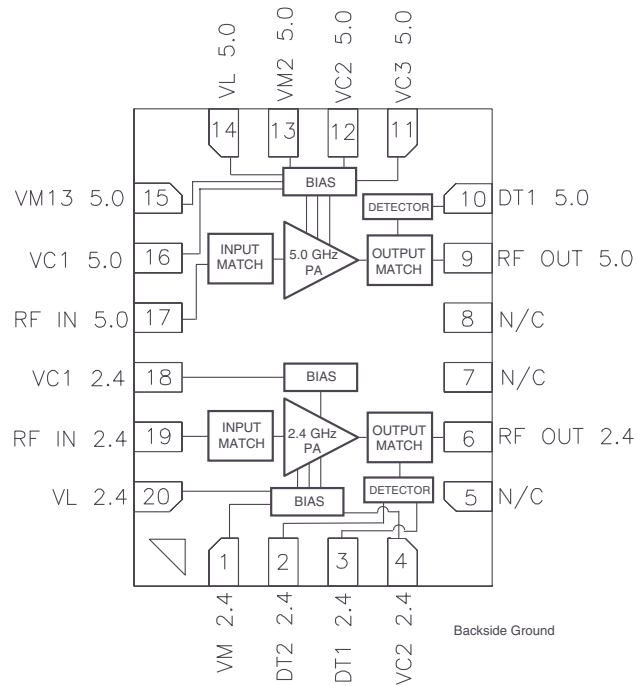

Pin	Description
1	VM 2.4
2	DT2 2.4
3	DT1 2.4 (Vdet)
4	VC2 2.4
5	N/C
6	RF OUT 2.4
7	N/C
8	N/C
9	RF OUT 5.0
10	DT1 5.0 (Vdet)
11	VC3 5.0
12	VC2 5.0
13	VM2 5.0
14	VL 5.0
15	VM13 5.0
16	VC1 5.0
17	RF IN 5.0
18	VC1 2.4
19	RF IN 2.4
20	VL 2.4

Performance Data

802.11g/a Frequency Dependency

RMPA2550 Total Measured EVM Vs. Modulated Pout
 2.40 to 2.50 GHz VM, VC=3.3V T=25C
 Data Rate 54Mbps OFDM 16.7MHz

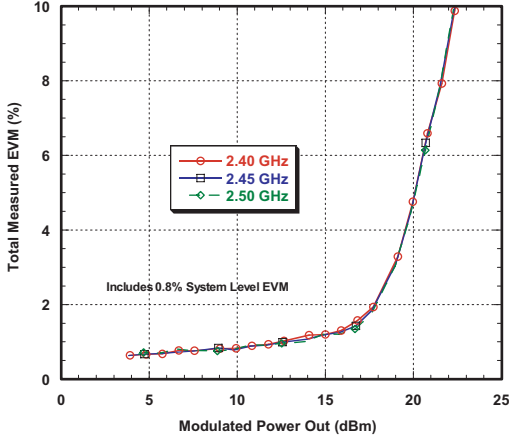

RMPA2550 Total Measured EVM Vs. Modulated Pout
 5.15 to 5.85 GHz VM, VC=3.3V T=25C
 Data Rate 54Mbps OFDM 16.7MHz

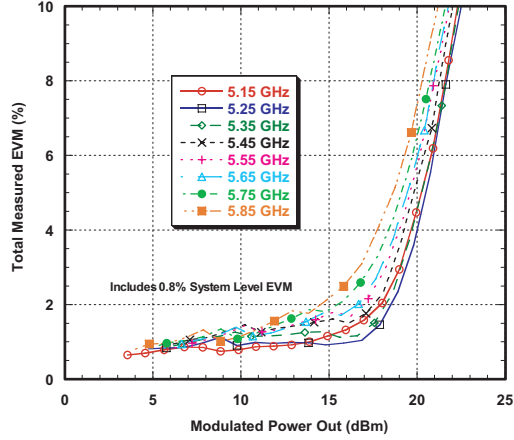

RMPA2550 Detector Voltage Vs. Modulated Pout
 2.40 to 2.50 GHz VM, VC=3.3V T=25C
 Data Rate 54Mbps OFDM 16.7MHz

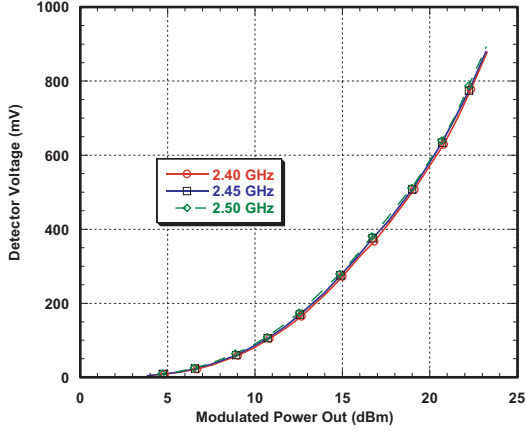

RMPA2550 Detector Voltage Vs. Modulated Pout
 5.15 to 5.85 GHz VM, VC=3.3V T=25C
 Data Rate 54Mbps OFDM 16.7MHz

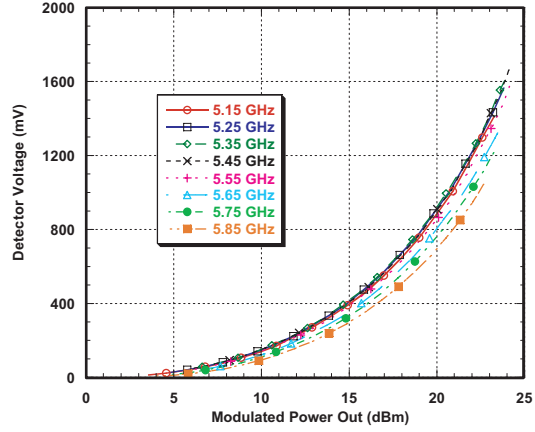

RMPA2550 Total Current Vs. Modulated Pout
 2.40 to 2.50 GHz VM, VC=3.3V T=25C
 Data Rate 54Mbps OFDM 16.7MHz

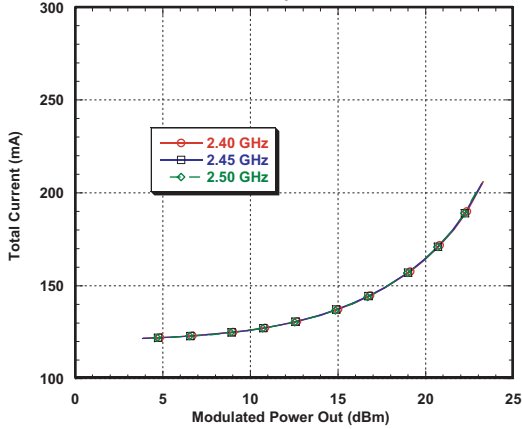

RMPA2550 Total Current Vs. Modulated Pout
 5.15 to 5.85 GHz VM, VC=3.3V T=25C
 Data Rate 54Mbps OFDM 16.7MHz

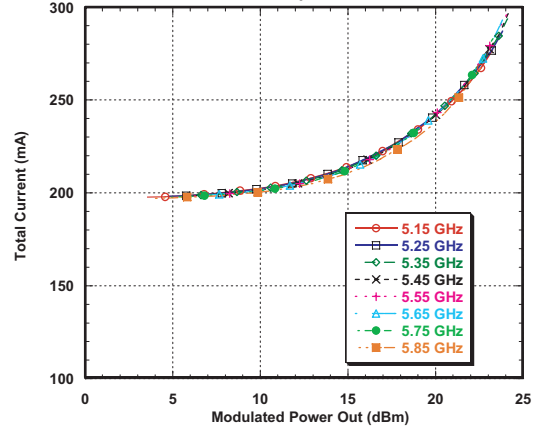

Performance Data (Continued)

802.11g/a Frequency Dependency (continued)

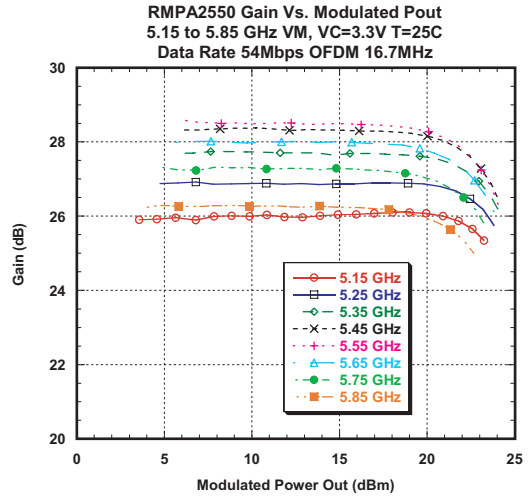
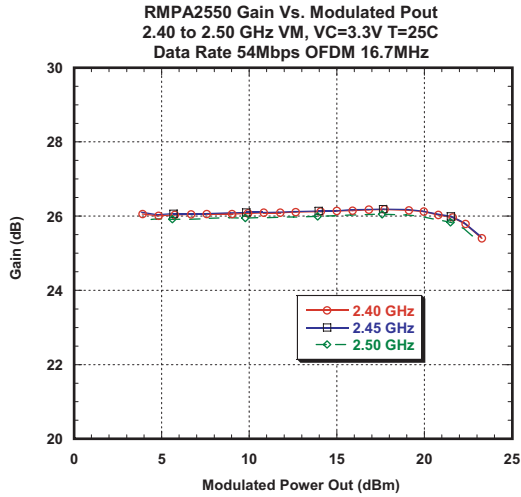

802.11g/a Temperature Dependency

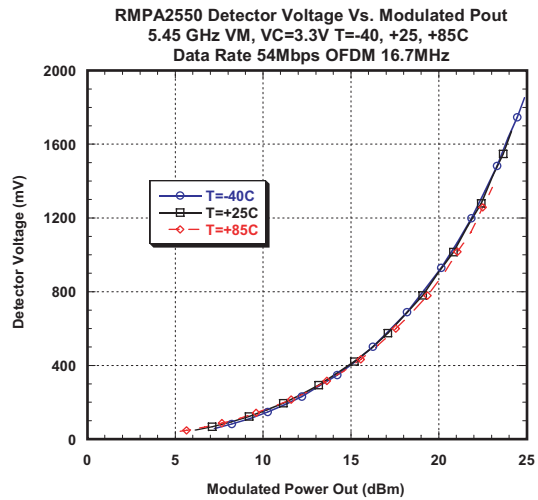
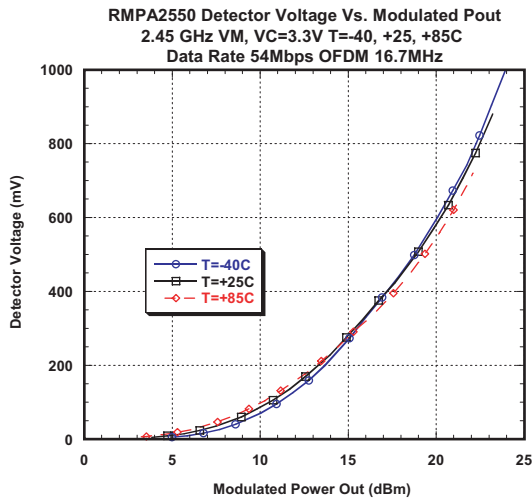
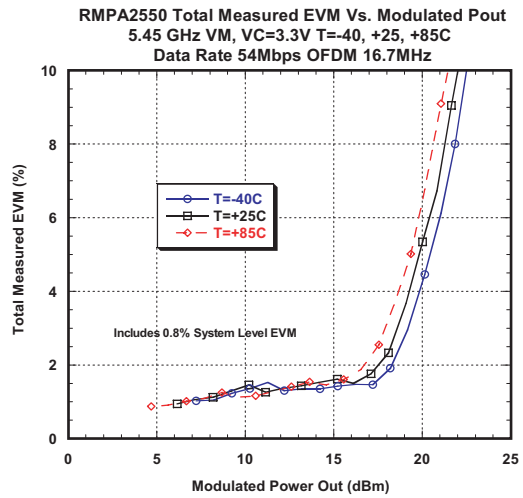
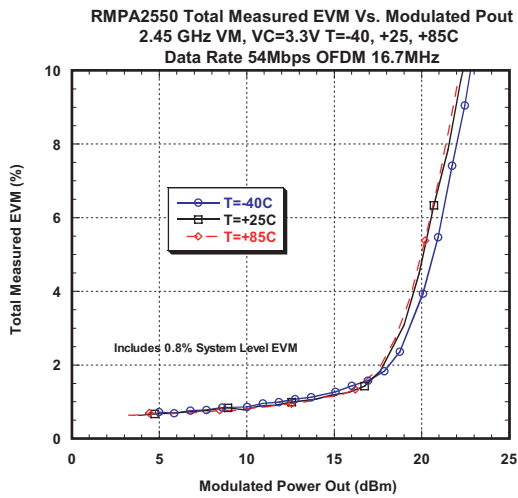

Performance Data (Continued)
802.11g/a Temperature Dependency (continued)

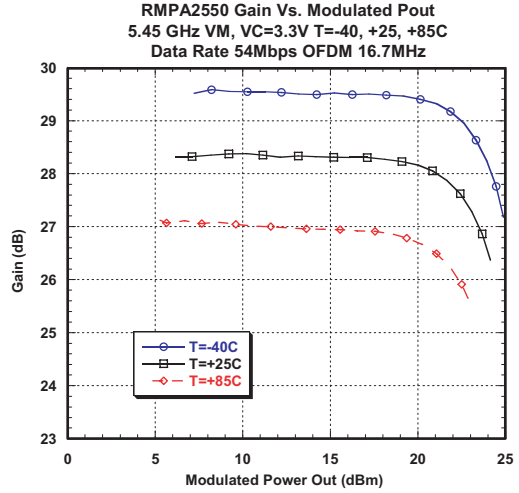
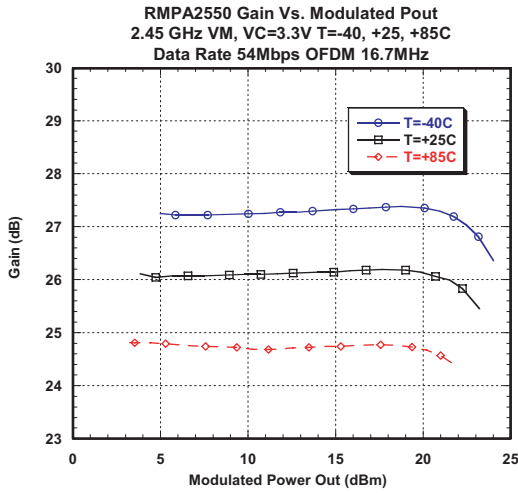
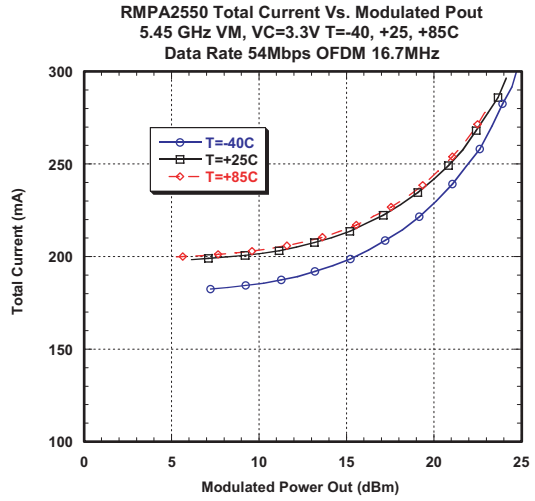
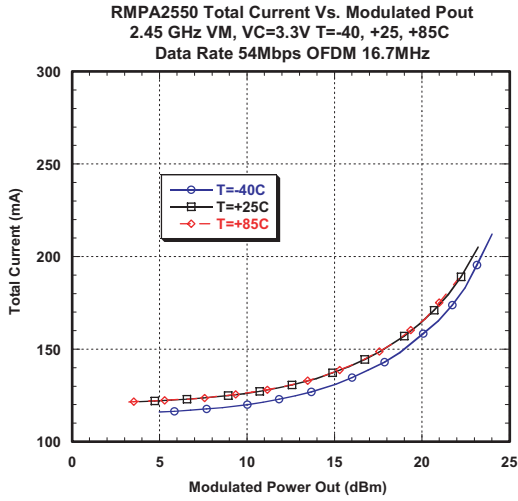

802.11g/a VM Dependency

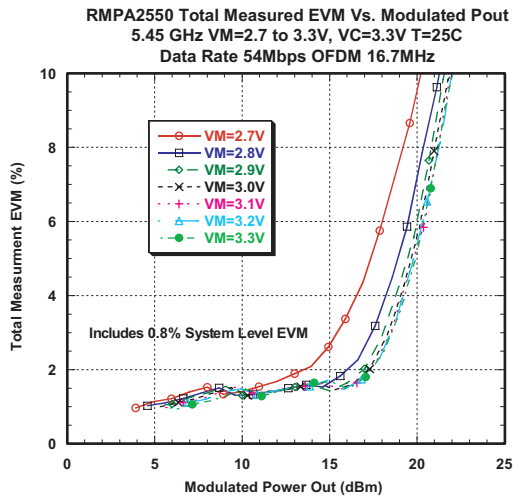
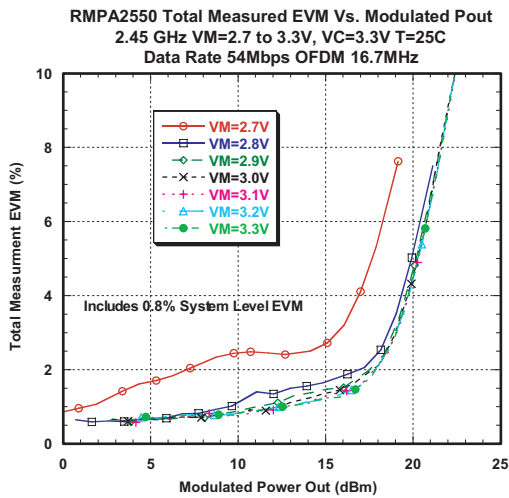

Performance Data (Continued)
802.11g/a VM Dependency (continued)

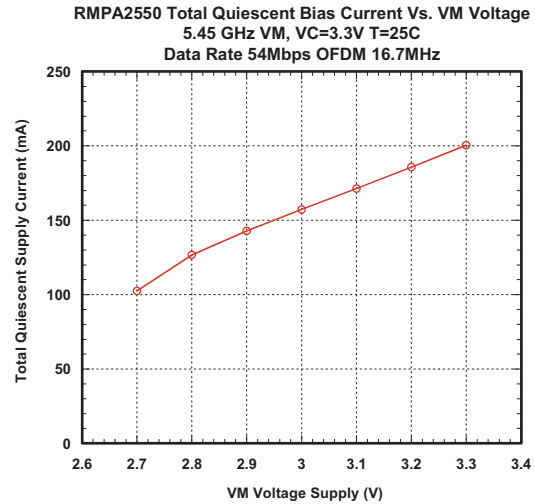
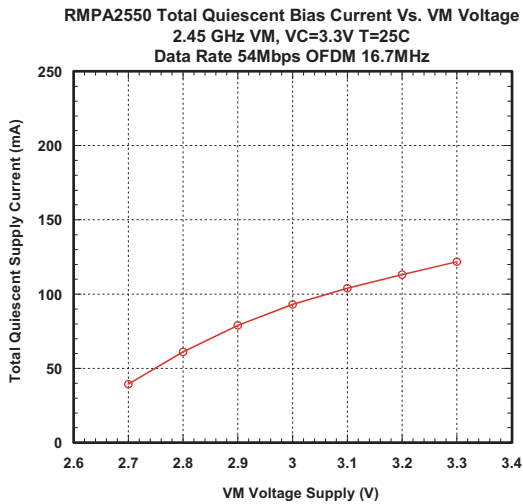
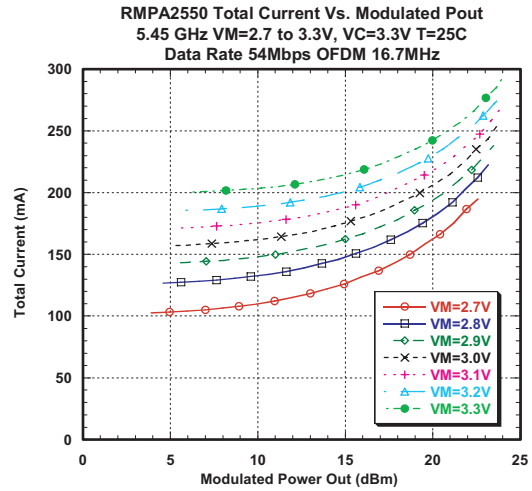
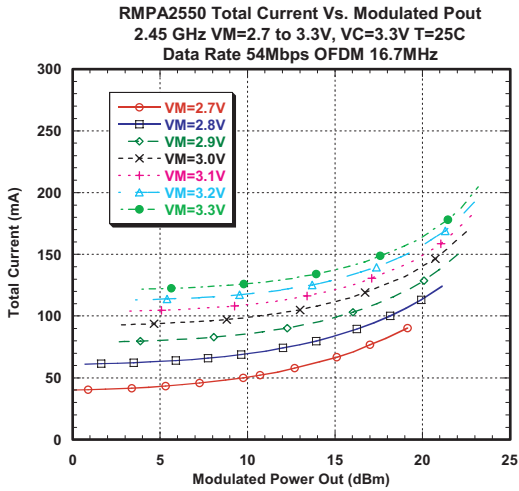
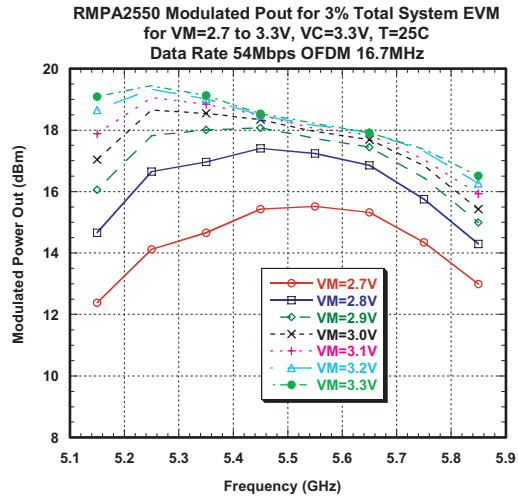
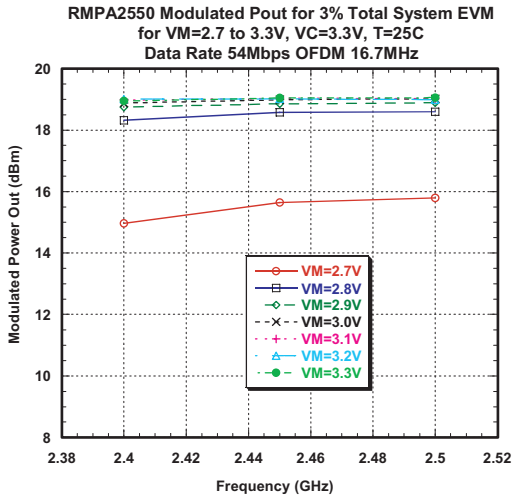

Performance Data (Continued)

Single Tone

RMPA2550 Single Tone Gain Vs. Power Out
2.40 to 2.50 GHz VM, VC=3.3V T=25C

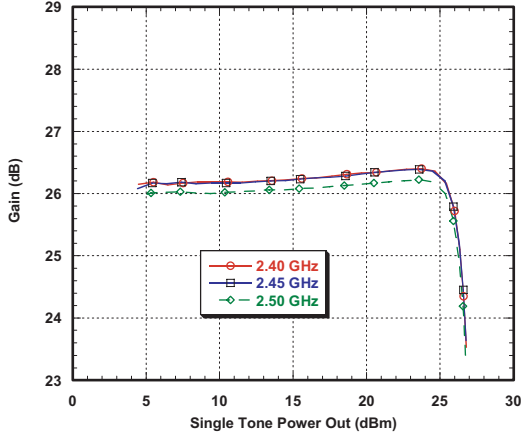

RMPA2550 Single Tone Gain Vs. Power Out
5.15 to 5.85 GHz VM, VC=3.3V T=25C

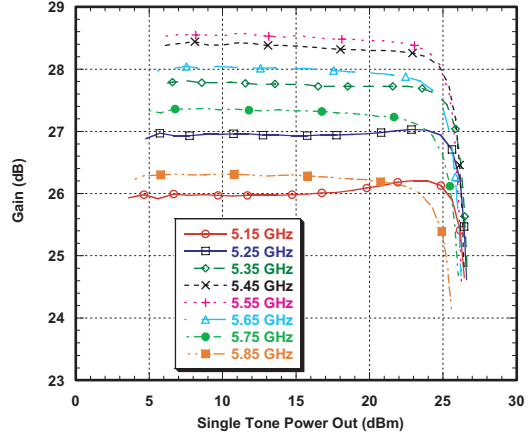

RMPA2550 Single Tone Gain Vs. Power Out
2.45 GHz VM, VC=3.3V T=-40, +25, +85C

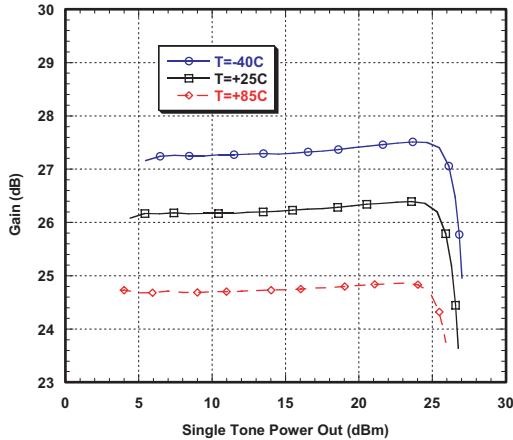

RMPA2550 Single Tone Gain Vs. Power Out
5.45 GHz VM, VC=3.3V T=-40, +25, +85C

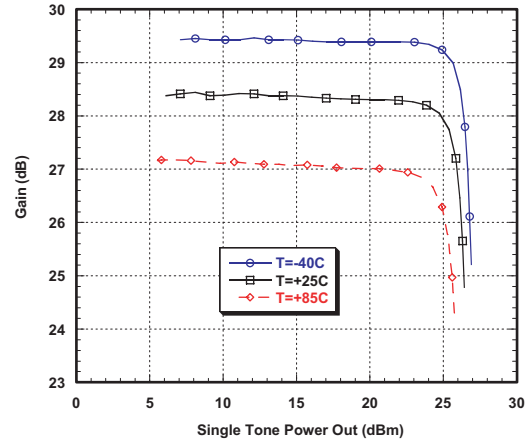

RMPA2550 S-Parameters
2.4 GHz Band T=25C VM, VC=3.3V

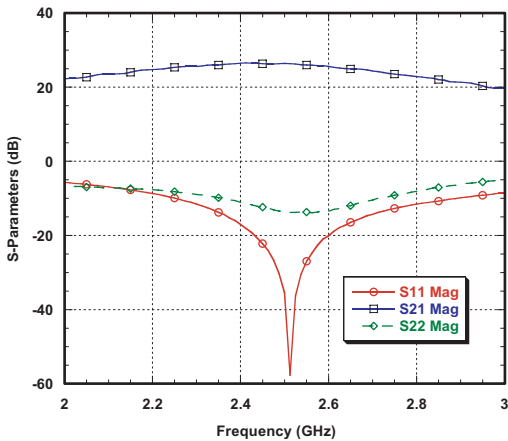

RMPA2550 S-Parameters
5.0 GHz Band T=25C VM, VC=3.3V

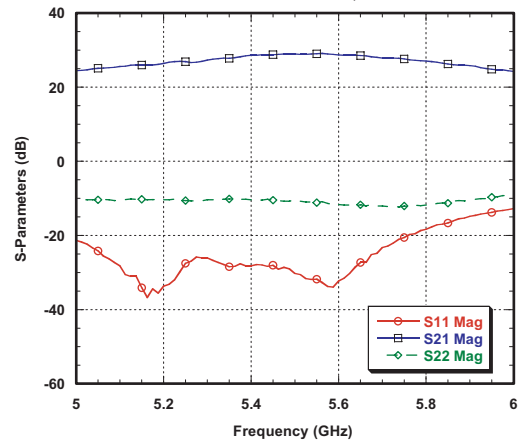

Performance Data (Continued)

802.11g/a/b Spectral Mask

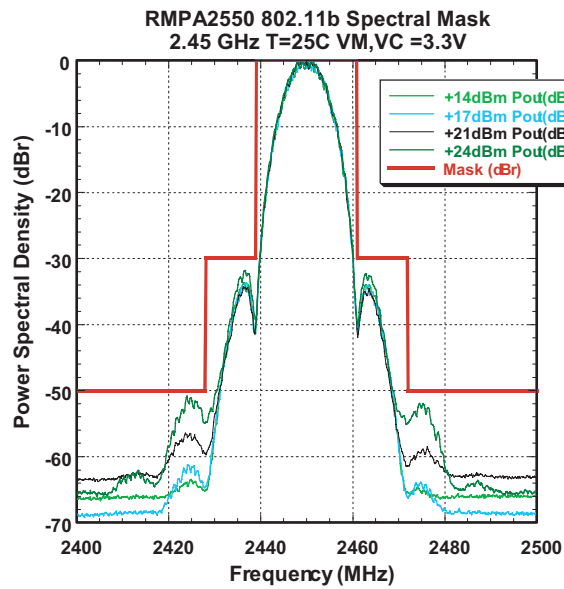
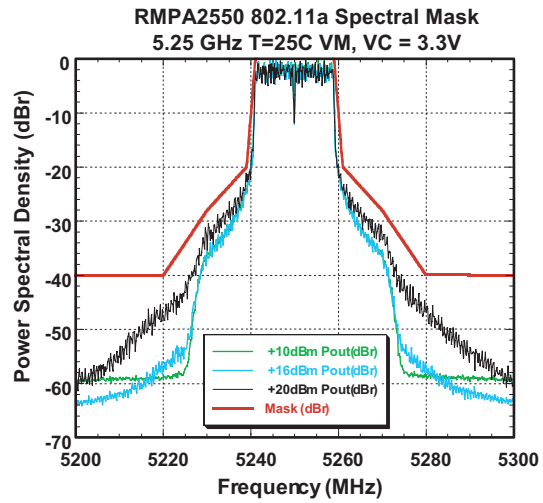
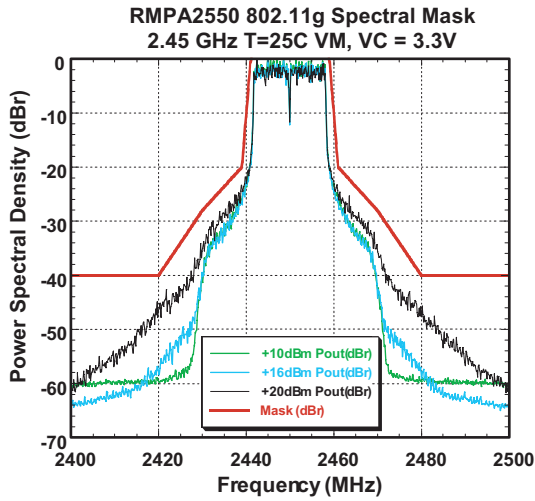

Package Outline

Dimensions in inches [mm]

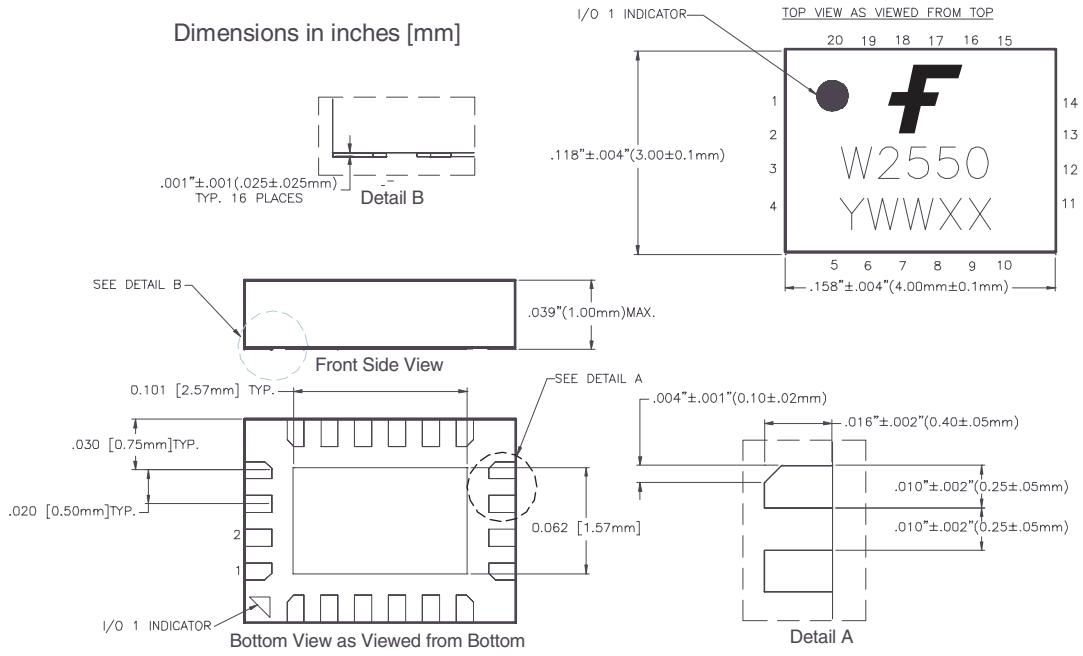

Evaluation Board Schematic

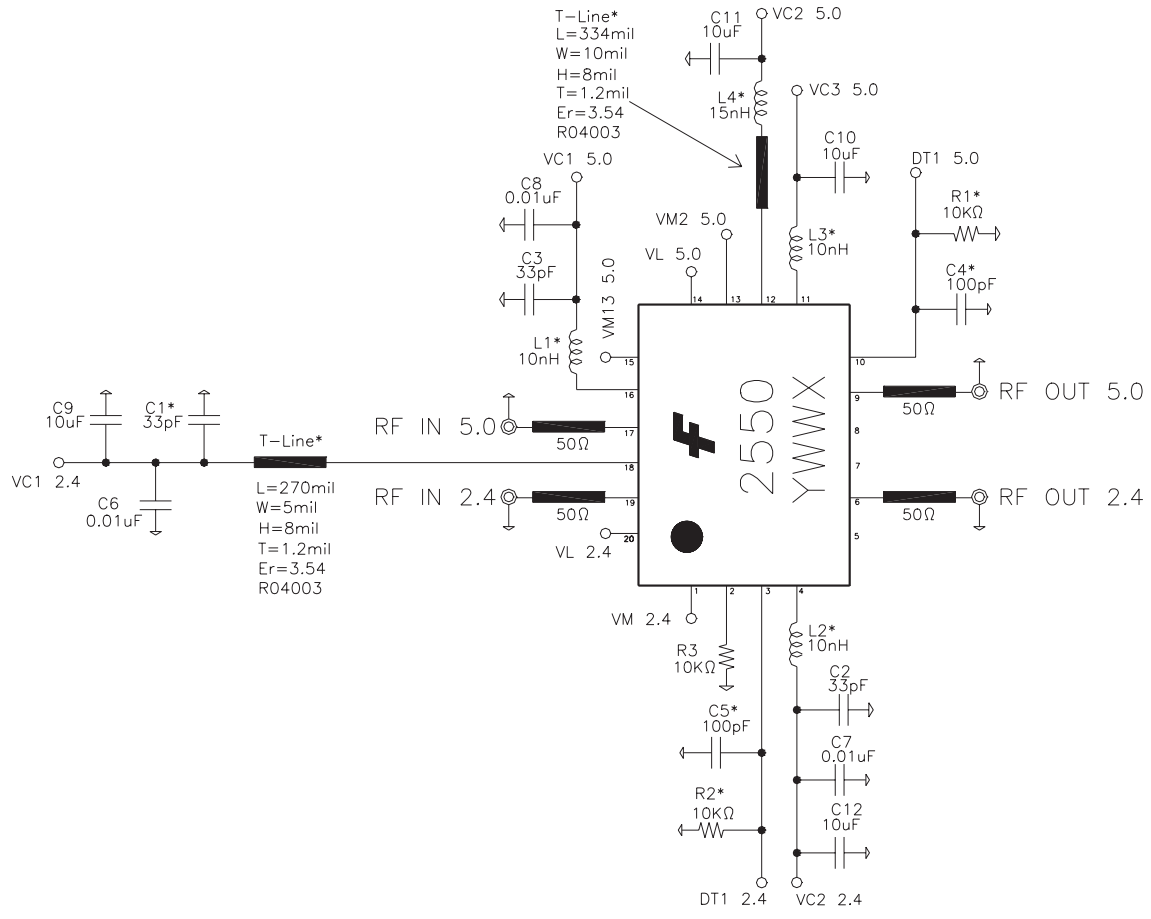

Evaluation Board Bill of Materials

MATERIALS LIST

QTY	ITEM NO.	PART NUMBER	DESCRIPTION	VENDOR
1	1	G657632	PC, BOARD	
4	2	#142-0701-841	SMA CONNECTOR	JOHNSON
3	3 (L1,L2&L3)	LLV1005FB10NJ	10 nH INDUCTOR	TOKO
1	4 (L4)	LLV1005FB15NJ	15 nH INDUCTOR	TOKO
3	5 (R1,R2&R3)	RCI-0402-1002FT	10K OHM RESISTOR	IMS
2	6 (C1&C2)	GRM39C0G330J050AD	33 pF CAPACITOR	MURATA
2	7 (C3&C4)	GRM36C0G101J50V	100 pF CAPACITOR	MURATA
2	8 (C5&C6)	GMC10X7R103M25NT	.01 uF CAPACITOR	MURATA
4	9 (C7,C8,C9&C10)	GRM21BR60J106KE01L	10 uF CAPACITOR (6.0V)	MURATA
A/R	10	SN63	SOLDER PASTE	INDIUM CORP
A/R	11	SN96	SOLDER PASTE	INDIUM CORP
22	12	S1322-36-ND	RIGHT ANGLE SINGLE HEADER	DIGIKEY
REF	13	G657650	ASSEMBLY, RMPA2550	

Evaluation Board Layout

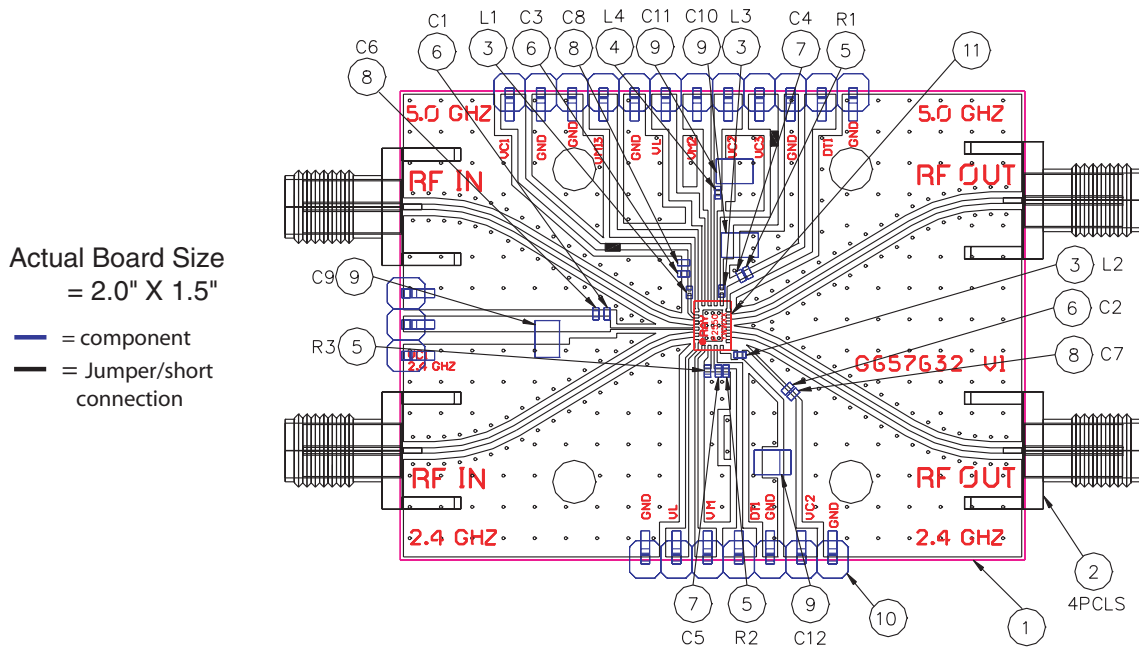

Actual Board Size = 2.0" X 1.5"

Evaluation Board Turn-On Sequence¹

- 1) Connect RF ports to RF test equipment.
- 2) Connect common ground terminal to the Ground (GND) pin on the board.
- 3) Connect terminals VC1 5.0, VC2 5.0, VC3 5.0, VC1 2.4, VC2 2.4 together and apply to positive supply (VC=3.3V).
- 4) Connect terminals VM 2.4, VM2 5.0 and VM13 5.0 together and connect to positive supply (VM=3.3V).
- 5) Connect voltmeter to Detector Output, pin DT1 5.0 and to DT1 2.4.
- 6) Connect logic control pins VL 5.0 and VL 2.4 together and apply 0V. *Now only the 2.4GHz PA is on.* Observe the following positive currents flowing into the pins:

Pin	Current
VL 2.4	<1 nA
VC (total) 2.4	80 – 110 mA
VM 2.4	12 – 15 mA

Pin	Current
VL 5.0	<1 nA
VC (total) 5.0	<1 nA
VM (total) 5.0	<1.9 mA

- 7) Apply positive voltage of +3.0V to logic control pins VL 5.0 and VL 2.4. *Now only the 5GHz PA is on.* Observe the following positive currents flowing into the pins:

Pin	Current
VL 5.0	~150 μ A
VC (total) 5.0	~184 mA
VM 5.0	~16 mA

Pin	Current
VL 2.4	<0.25mA
VC (total) 2.4	<1 nA
VM 2.4	<0.7mA

- 8) Apply input RF power to SMA connector pin RF IN 2.4 or RF IN 5.0. Currents on collector pins will vary depending on the input drive level.

Recommended turn-off sequence:

Use reverse order described in the turn-on sequence on the previous page.

Note:

1. Turn on sequence is not critical and it is not necessary to sequence power supplies in actual system level design.

Application Information

Precautions to Avoid Permanent Device Damage:

Static Sensitivity: Follow ESD precautions to protect against ESD damage:

- A properly grounded static-dissipative surface on which to place devices.
- Static-dissipative floor or mat.
- A properly grounded conductive wrist strap for each person to wear while handling devices.

TRADEMARKS

The following are registered and unregistered trademarks Fairchild Semiconductor owns or is authorized to use and is not intended to be an exhaustive list of all such trademarks.

ACEx™	FAST®	ISOPLANAR™	Power247™	SuperFET™
ActiveArray™	FASTr™	LittleFET™	PowerSaver™	SuperSOT™-3
Bottomless™	FPST™	MICROCOUPLER™	PowerTrench®	SuperSOT™-6
CoolFET™	FRFET™	MicroFET™	QFET®	SuperSOT™-8
CROSSVOLT™	GlobalOptoisolator™	MicroPak™	QS™	SyncFET™
DOMET™	GTO™	MICROWIRE™	QT Optoelectronics™	TinyLogic®
EcoSPARK™	HiSeC™	MSX™	Quiet Series™	TINYOPTO™
E ² C MOS™	ꞑC™	MSXPro™	RapidConfigure™	TruTranslation™
EnSigna™	i-Lo™	OCX™	RapidConnect™	UHC™
FACT™	ImpliedDisconnect™	OCXPro™	µSerDes™	UltraFET®
FACT Quiet Series™		OPTOLOGIC®	SILENT SWITCHER®	VCX™
Across the board. Around the world.™		OPTOPLANAR™	SMART START™	
The Power Franchise®		PACMAN™	SPM™	
Programmable Active Droop™		POP™	Stealth™	

DISCLAIMER

FAIRCHILD SEMICONDUCTOR RESERVES THE RIGHT TO MAKE CHANGES WITHOUT FURTHER NOTICE TO ANY PRODUCTS HEREIN TO IMPROVE RELIABILITY, FUNCTION OR DESIGN. FAIRCHILD DOES NOT ASSUME ANY LIABILITY ARISING OUT OF THE APPLICATION OR USE OF ANY PRODUCT OR CIRCUIT DESCRIBED HEREIN; NEITHER DOES IT CONVEY ANY LICENSE UNDER ITS PATENT RIGHTS, NOR THE RIGHTS OF OTHERS.

LIFE SUPPORT POLICY

FAIRCHILD'S PRODUCTS ARE NOT AUTHORIZED FOR USE AS CRITICAL COMPONENTS IN LIFE SUPPORT DEVICES OR SYSTEMS WITHOUT THE EXPRESS WRITTEN APPROVAL OF FAIRCHILD SEMICONDUCTOR CORPORATION. As used herein:

1. Life support devices or systems are devices or systems which, (a) are intended for surgical implant into the body, or (b) support or sustain life, or (c) whose failure to perform when properly used in accordance with instructions for use provided in the labeling, can be reasonably expected to result in significant injury to the user.
2. A critical component is any component of a life support device or system whose failure to perform can be reasonably expected to cause the failure of the life support device or system, or to affect its safety or effectiveness.

PRODUCT STATUS DEFINITIONS

Definition of Terms

Datasheet Identification	Product Status	Definition
Advance Information	Formative or In Design	This datasheet contains the design specifications for product development. Specifications may change in any manner without notice.
Preliminary	First Production	This datasheet contains preliminary data, and supplementary data will be published at a later date. Fairchild Semiconductor reserves the right to make changes at any time without notice in order to improve design.
No Identification Needed	Full Production	This datasheet contains final specifications. Fairchild Semiconductor reserves the right to make changes at any time without notice in order to improve design.
Obsolete	Not In Production	This datasheet contains specifications on a product that has been discontinued by Fairchild semiconductor. The datasheet is printed for reference information only.