

NHPV08S600G, NHPJ08S600G

Switch Mode Power Rectifiers

Features

- Ultrafast 30 Nanosecond Recovery Time
- 150°C Operating Junction Temperature
- High Voltage Capability of 600 V
- Low Forward Drop
- Low Leakage Specified @ 125°C Case Temperature
- These Devices are Pb-Free and RoHS Compliant
- NHPJ08S600G is a Halogen Free/BFR Free Device

Mechanical Characteristics:

- Case: Epoxy, Molded
- Weight: 1.9 Grams (Approximately)
- Finish: All External Surfaces Corrosion Resistant and Terminal Leads are Readily Solderable
- Lead Temperature for Soldering Purposes: 260°C Max. for 10 Seconds



ON Semiconductor®

<http://onsemi.com>

PLANAR ULTRAFAST RECTIFIERS 8 A, 600 V

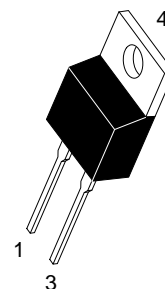
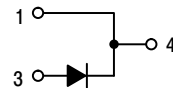

TO-220AC
CASE 221B

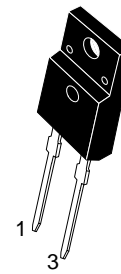

TO-220 FULLPAK
CASE 221AG

MARKING DIAGRAMS

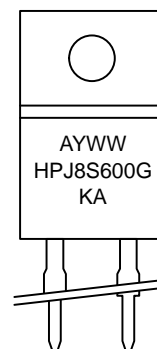
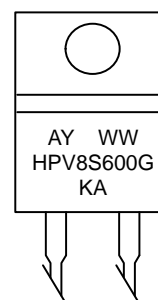

- A = Assembly Location
- Y = Year
- WW = Work Week
- G = Pb-Free Package
- KA = Diode Polarity

*For additional information on our Pb-Free strategy and soldering details, please download the ON Semiconductor Soldering and Mounting Techniques Reference Manual, SOLDERRM/D.

ORDERING INFORMATION

See detailed ordering and shipping information in the package dimensions section on page 2 of this data sheet.

NHPV08S600G, NHPJ08S600G

MAXIMUM RATINGS

Rating	Symbol	Value	Unit
Peak Repetitive Reverse Voltage Working Peak Reverse Voltage DC Blocking Voltage	V_{RRM} V_{RWM} V_R	600	V
Average Rectified Forward Current (Rated V_R)	TO-220AC TO-220FP $I_{F(AV)}$	8 A @ $T_C = 130^\circ\text{C}$ 8 A @ $T_C = 95^\circ\text{C}$	A
Peak Rectified Forward Current (Rated V_R , Square Wave, 20 kHz)	TO-220AC TO-220FP I_{FRM}	8 A @ $T_C = 125^\circ\text{C}$ 8 A @ $T_C = 85^\circ\text{C}$	A
Nonrepetitive Peak Surge Current (Surge applied at rated load conditions halfwave, single phase, 60 Hz)	I_{FSM}	80	A
Operating Junction Temperature and Storage Temperature Range	T_J, T_{stg}	-55 to +150	$^\circ\text{C}$

Stresses exceeding Maximum Ratings may damage the device. Maximum Ratings are stress ratings only. Functional operation above the Recommended Operating Conditions is not implied. Extended exposure to stresses above the Recommended Operating Conditions may affect device reliability.

THERMAL CHARACTERISTICS

Characteristic	Symbol	Value	Unit
NHPV08S600G: Thermal Resistance Junction-to-Case (Note 1)	$R_{\theta JC}$	1.5	$^\circ\text{C}/\text{W}$
NHPJ08S600G: Thermal Resistance Junction-to-Case (Note 1)	$R_{\theta JC}$	4.25	$^\circ\text{C}/\text{W}$

1. Junction-to-Case shown as a typical value using a fixed 25°C cold plate boundary.

ELECTRICAL CHARACTERISTICS

Characteristic	Test Conditions	Symbol	Typ	Max	Unit
Instantaneous Forward Voltage (Note 2)	($I_F = 8\text{ A}, T_C = 125^\circ\text{C}$) ($I_F = 8\text{ A}, T_C = 25^\circ\text{C}$)	v_F	1.5 2.7	1.8 3.2	V
Instantaneous Reverse Current (Note 2)	(Rated DC Voltage, $T_C = 125^\circ\text{C}$) (Rated DC Voltage, $T_C = 25^\circ\text{C}$)	i_R	46 0.1	400 30	μA
Reverse Recovery Time	($I_F = 0.5\text{ A}, I_{rr} = 0.25\text{ A}, I_R = 1\text{ A}$) ($I_F = 1\text{ A}, di_F/dt = -50\text{ A}/\mu\text{s}, V_R = 30\text{ V}$)	t_{rr}	- -	30 50	ns
Reverse Recovery Time Peak Reverse Recovery Current Total Reverse Recovery Charge Softness Factor	($I_F = 8\text{ A}, di_F/dt = -200\text{ A}/\mu\text{s}, T_C = 25^\circ\text{C}$)	t_{rr} I_{RM} Q_{rr} S	30 2.3 37 2	50 3 50 -	ns A nC -
Reverse Recovery Time Peak Reverse Recovery Current Total Reverse Recovery Charge Softness Factor	($I_F = 8\text{ A}, di_F/dt = -200\text{ A}/\mu\text{s}, T_C = 125^\circ\text{C}$)	t_{rr} I_{RM} Q_{rr} S	45 5.5 150 0.35	- - - -	ns A nC -
Forward Recovery Time Peak Forward Recovery Voltage	($I_F = 8\text{ A}, di_F/dt = 120\text{ A}/\mu\text{s}, T_C = 25^\circ\text{C}$)	t_{fr} V_{FP}	- -	200 6	ns V

2. Pulse Test: Pulse Width = 300 μs , Duty Cycle $\leq 2.0\%$.

ORDERING INFORMATION

Device	Package	Shipping†
NHPV08S600G	TO-220AC (Pb-Free)	50 Units / Rail
NHPJ08S600G	TO-220FP (Pb-Free / Halide-Free)	50 Units / Rail

†For information on tape and reel specifications, including part orientation and tape sizes, please refer to our Tape and Reel Packaging Specifications Brochure, BRD8011/D.

TYPICAL CHARACTERISTICS

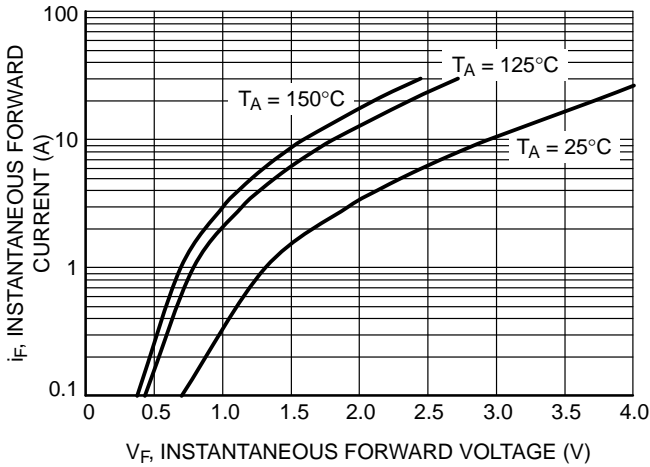

Figure 1. Typical Instantaneous Forward Characteristics

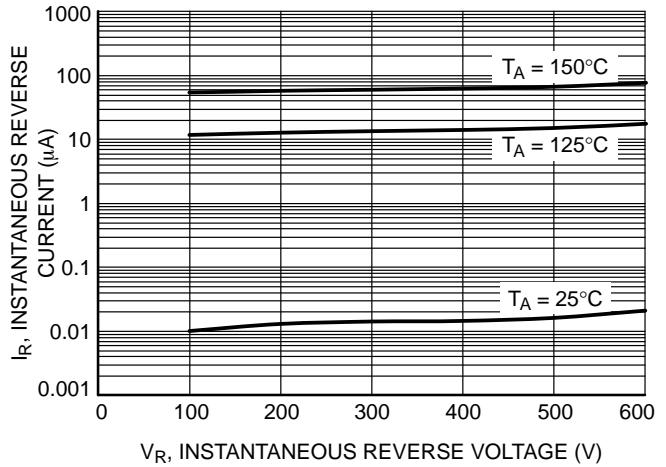

Figure 2. Typical Reverse Characteristics

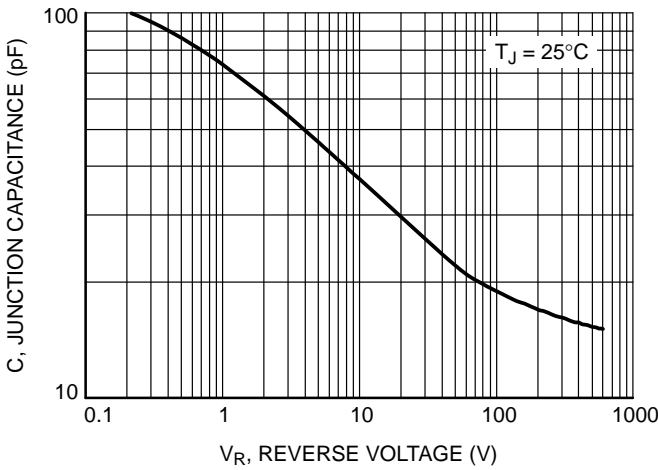

Figure 3. Typical Junction Capacitance

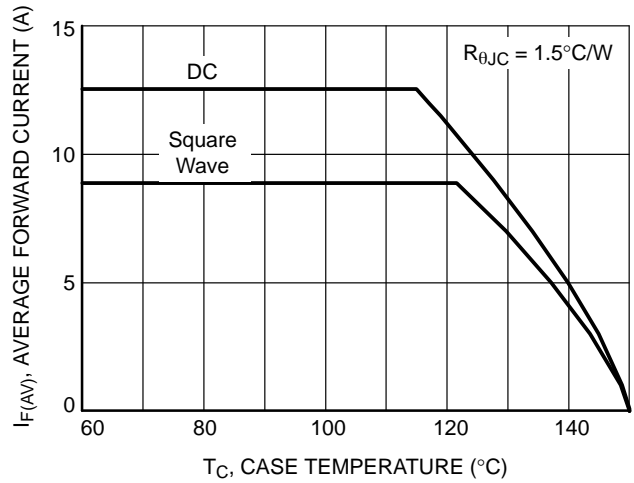

Figure 4. Current Derating TO-220AC

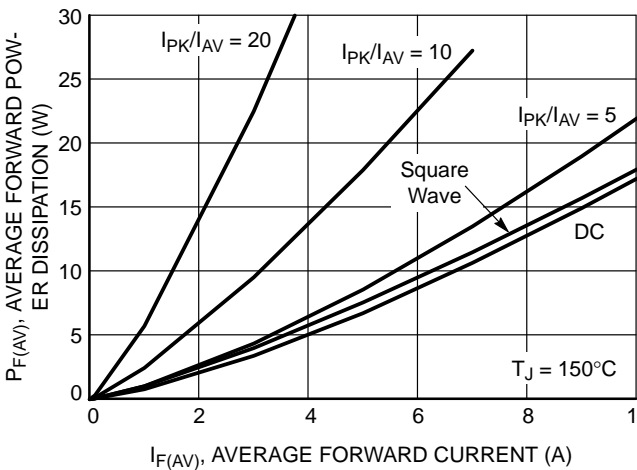

Figure 5. Forward Power Dissipation

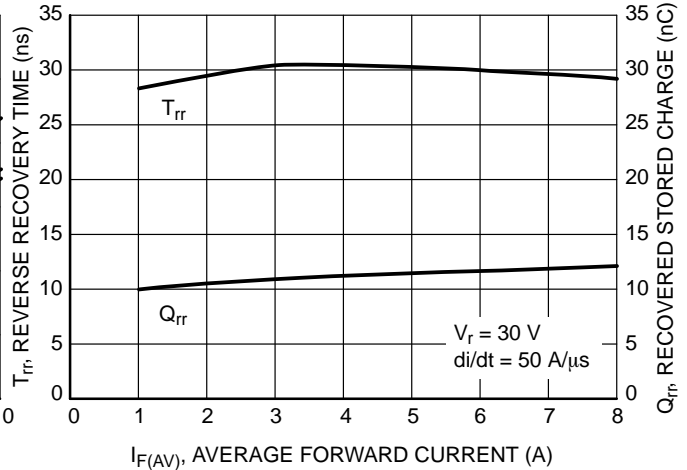
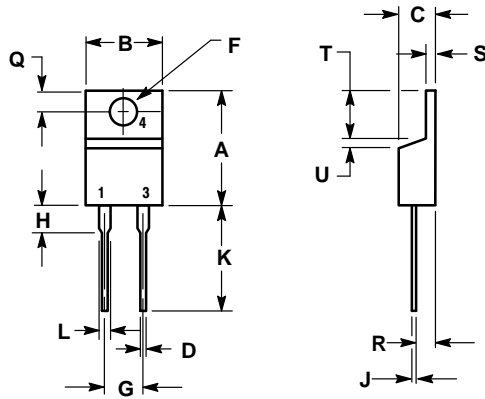

Figure 6. Typical Recovery Characteristics

NHPV08S600G, NHPJ08S600G

PACKAGE DIMENSIONS

TO-220 TWO-LEAD CASE 221B-04 ISSUE E



- NOTES:
1. DIMENSIONING AND TOLERANCING PER ANSI Y14.5M, 1982.
 2. CONTROLLING DIMENSION: INCH.

DIM	INCHES		MILLIMETERS	
	MIN	MAX	MIN	MAX
A	0.595	0.620	15.11	15.75
B	0.380	0.405	9.65	10.29
C	0.160	0.190	4.06	4.82
D	0.025	0.035	0.64	0.89
F	0.142	0.161	3.61	4.09
G	0.190	0.210	4.83	5.33
H	0.110	0.130	2.79	3.30
J	0.014	0.025	0.36	0.64
K	0.500	0.562	12.70	14.27
L	0.045	0.060	1.14	1.52
Q	0.100	0.120	2.54	3.04
R	0.080	0.110	2.04	2.79
S	0.045	0.055	1.14	1.39
T	0.235	0.255	5.97	6.48
U	0.000	0.050	0.000	1.27

TO-220 FULLPAK, 2-LEAD CASE 221AG ISSUE O

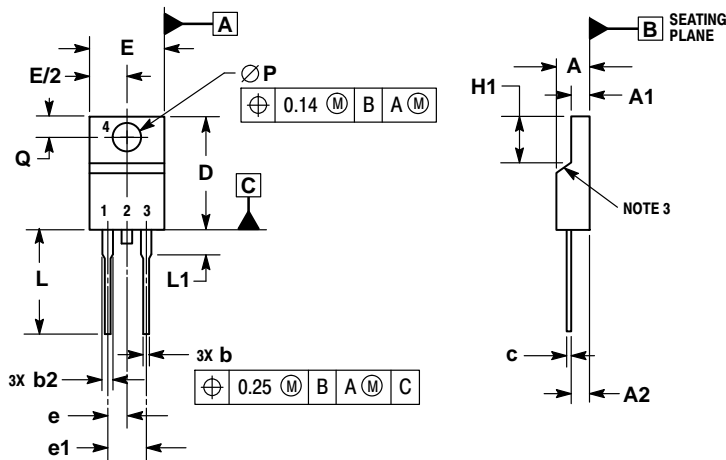

- NOTES:
1. DIMENSIONING AND TOLERANCING PER ASME Y14.5M, 1994.
 2. CONTROLLING DIMENSION: MILLIMETERS.
 3. CONTOUR UNCONTROLLED IN THIS AREA.
 4. DIMENSIONS D AND E DO NOT INCLUDE MOLD FLASH AND GATE PROTRUSIONS. MOLD FLASH AND GATE PROTRUSIONS NOT TO EXCEED 0.13 PER SIDE. THESE DIMENSIONS ARE TO BE MEASURED AT OUTERMOST EXTREME OF THE PLASTIC BODY.
 5. DIMENSION b2 DOES NOT INCLUDE DAMBAR PROTRUSION. LEAD WIDTH INCLUDING PROTRUSION SHALL NOT EXCEED 2.00.

DIM	MILLIMETERS	
	MIN	MAX
A	4.30	4.70
A1	2.50	2.90
A2	2.50	2.70
b	0.54	0.84
b2	1.10	1.40
c	0.49	0.79
D	14.22	15.88
E	9.65	10.67
e	2.54 BSC	
e1	5.08 BSC	
H1	5.97	6.48
L	12.70	14.73
L1	---	2.80
P	3.00	3.40
Q	2.80	3.20

ON Semiconductor and are registered trademarks of Semiconductor Components Industries, LLC (SCILLC). SCILLC owns the rights to a number of patents, trademarks, copyrights, trade secrets, and other intellectual property. A listing of SCILLC's product/patent coverage may be accessed at www.onsemi.com/site/pdf/Patent-Marking.pdf. SCILLC reserves the right to make changes without further notice to any products herein. SCILLC makes no warranty, representation or guarantee regarding the suitability of its products for any particular purpose, nor does SCILLC assume any liability arising out of the application or use of any product or circuit, and specifically disclaims any and all liability, including without limitation special, consequential or incidental damages. "Typical" parameters which may be provided in SCILLC data sheets and/or specifications can and do vary in different applications and actual performance may vary over time. All operating parameters, including "Typicals" must be validated for each customer application by customer's technical experts. SCILLC does not convey any license under its patent rights nor the rights of others. SCILLC products are not designed, intended, or authorized for use as components in systems intended for surgical implant into the body, or other applications intended to support or sustain life, or for any other application in which the failure of the SCILLC product could create a situation where personal injury or death may occur. Should Buyer purchase or use SCILLC products for any such unintended or unauthorized application, Buyer shall indemnify and hold SCILLC and its officers, employees, subsidiaries, affiliates, and distributors harmless against all claims, costs, damages, and expenses, and reasonable attorney fees arising out of, directly or indirectly, any claim of personal injury or death associated with such unintended or unauthorized use, even if such claim alleges that SCILLC was negligent regarding the design or manufacture of the part. SCILLC is an Equal Opportunity/Affirmative Action Employer. This literature is subject to all applicable copyright laws and is not for resale in any manner.

PUBLICATION ORDERING INFORMATION

LITERATURE FULFILLMENT:
Literature Distribution Center for ON Semiconductor
P.O. Box 5163, Denver, Colorado 80217 USA
Phone: 303-675-2175 or 800-344-3860 Toll Free USA/Canada
Fax: 303-675-2176 or 800-344-3867 Toll Free USA/Canada
Email: orderlit@onsemi.com

N. American Technical Support: 800-282-9855 Toll Free
USA/Canada
Europe, Middle East and Africa Technical Support:
Phone: 421 33 790 2910
Japan Customer Focus Center
Phone: 81-3-5817-1050

ON Semiconductor Website: www.onsemi.com
Order Literature: <http://www.onsemi.com/orderlit>
For additional information, please contact your local Sales Representative