

# NCL30073LED3GEVB

## 15 W High Power Factor LED Driver Evaluation Board User's Manual



ON Semiconductor®

[www.onsemi.com](http://www.onsemi.com)

### EVAl BOARD USER'S MANUAL

#### Overview

This manual covers the specification, theory of operation, testing and construction of the NCL30073LED3GEVB evaluation board. The NCL30073 board demonstrates a 15 W high PF buck boost LED driver for a typical downlight application.

#### Key Features

The key features of this evaluation board include:

- Low Parts Count
- TRIAC Dimmer Compatible
- High Power Factor
- Integrated Fault Protection
  - ◆ Over Temperature on board (a PCB mounted PTC)
  - ◆ Output Over Current
  - ◆ Output Over Voltage

Table 1. SPECIFICATIONS

Input voltage	108 – 132 V ac	
Line Frequency	60 Hz	
Power Factor (100% Load)	0.9	Min
Output Voltage	72 V dc	
Output Ripple	75%	Pk – Pk
Output Current	200 mA dc	± 5%
Efficiency	88.5%	Typ.
Start Up Time	< 200 msec	Typ.

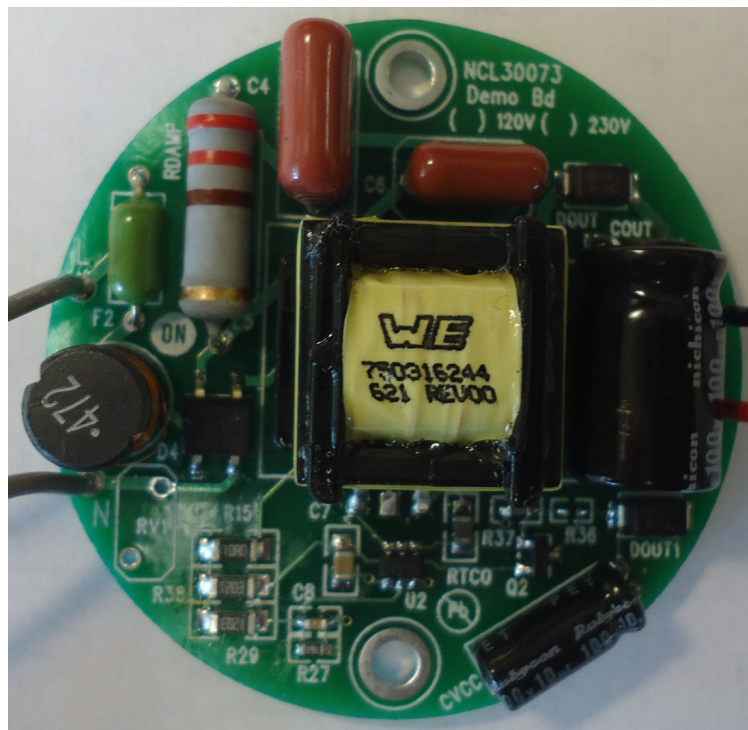

Figure 1. Evaluation Board Photo

# NCL30073LED3GEVB

## THEORY OF OPERATION

### Power Stage

The power stage is a flying buck boost design. In this configuration, drain of the switching FET is connected to the rectified HVDC and the source is switching. This has many benefits:

1. Direct output current sensing
2. Direct output voltage sensing
3. No Aux winding needed

The power stage operates as a fixed frequency DCM power stage. The DCM allows for no forced commutation of the output diode for good EMI performance. The fixed current/fixed frequency provides for a constant power control over a large portion of the input waveform. The resistor divider of R27 and R29 provides some wave shaping to improve the power factor. The input current waveform is made to be square for maximum TRIAC dimmer compatibility.

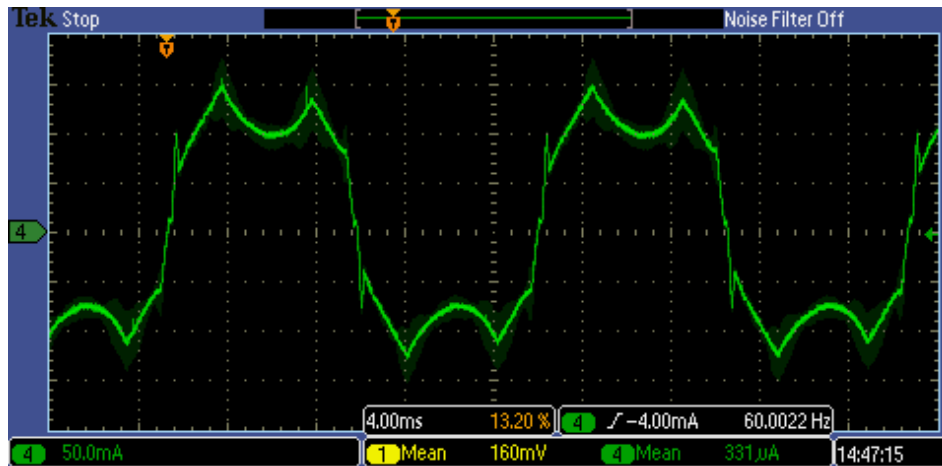

Figure 2.

### Output Voltage Sense and Vcc generation

Dout1 is in parallel with the output during the off time of the FET and stores energy in Cvcc. R36 and R37 divide the output voltage and Q2 buffers it to provide Vcc power to the controller. Since the divider is a fixed ratio, Vcc is a fixed percentage of the output voltage. When Vcc rises above 25 V, the controller detects and OVP fault. The maximum output voltage is set by adjusting the ratio of R36/R37.

In cases where the output has a lot of ripple current and the LED has high dynamic resistance, the peak output voltage can be much higher than the average output voltage. The inductor winding will charge the Cvcc to the peak of the output voltage which may trigger the OVP sooner than expected so in this case the peak voltage of the LED string is critical.

### Protection

#### Thermal Protection

Rtco is a PTC connected between the CS pin and Rsens. The controller creates an internal signal current from the CS pin. As the resistance of Rtco becomes larger with

temperature, the signal level at the CS pin increases causing the current to foldback with temperature.

#### Programmable OVP

R36 and R37 set Vcc as a fixed percentage of the output voltage. The OVP threshold on the controller is 25 V. So the ratio of R36/R37 is set to trip the Vcc OVP threshold at about 100 V output.

#### Overcurrent Protection

The controller has built in overcurrent limits.

#### Output Current

The output current is set by the value of Rsens. It's possible to adjust the output current by changing Rsens.

#### TRIAC Dimming Compatibility

The EMI filter components are selected to provide optimum damping of the EMI filter to eliminate ringback of the input current which will lead to loss of hold current in the dimmer. The square nature of the input current makes the best case for TRIAC holding current over the line cycle while still maintaining power factor above 0.9.

# NCL30073LED3GEVB

## SCHEMATIC

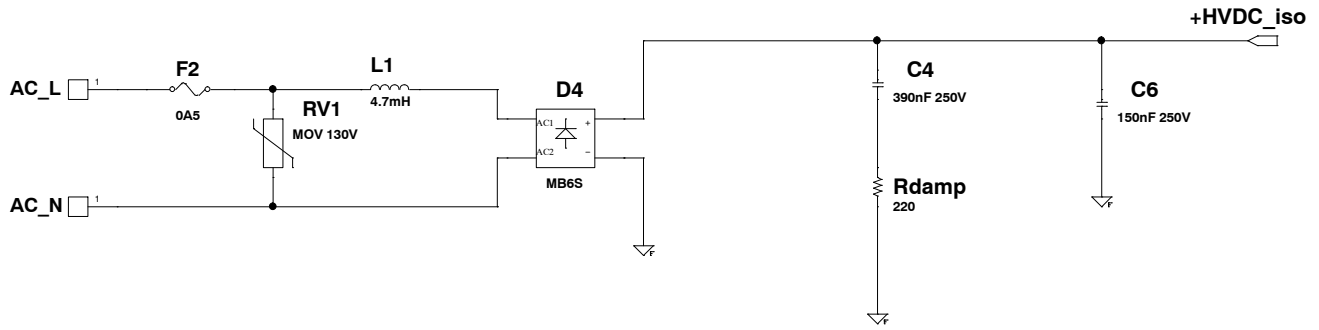

Figure 3. Input Circuit

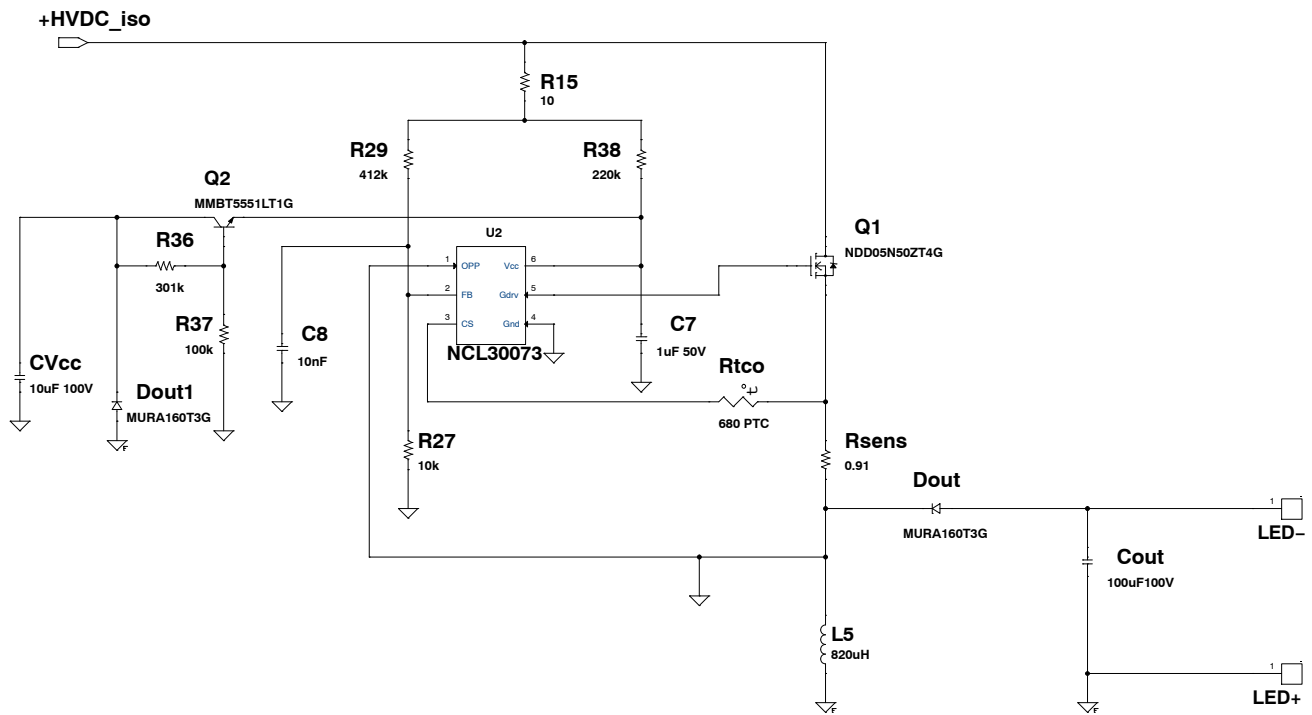

Figure 4. Main Circuit

# NCL30073LED3GEVB

## BILL OF MATERIAL

**Table 2. BILL OF MATERIAL**

Reference	Qty	Part	Distributor	Distributor Part Number	Manufacturer	Manufacturer Part Number	Substitution Allowed
CVcc	1	10 $\mu$ F 100 V	Rubycon	100YXJ10M5X11	Digikey	1189-2150-ND	Yes
Cout	1	100 $\mu$ F 100 V	Nichicon	UVK2A101MPD	Digikey	UVK2A101MPD-ND	Yes
C4	1	390 nF 250 V	Faratronic	C252E394-6B****+++	Faratronic	C252E394-6B****+++	Yes
C6	1	150 nF 250 V	Faratronic	C252E154-3B****+++	Faratronic	C252E154-3B****+++	Yes
C7	1	1 $\mu$ F 50 V	Yageo	CC0805KKX7R9BB105	Digikey	311-1886-1-ND	Yes
C8	1	10 nF	Yageo	CC0603KRX7R9BB103	Digikey	311-1085-1-ND	Yes
Dout1, Dout	2	MURA160T3G	ON Semiconductor	MURA160T3G	ON Semiconductor	MURA160T3G	No
D4	1	MB6S	MCC	MB6S	Digikey	MB4S-TPMSCT-ND	Yes
F2	1	0A5	Littelfuse	0263.500WRT1L	Digikey	F1999CT-ND	Yes
L1	1	4.7 mH	Würth	744772472	Digikey	732-3790-ND	Yes
L5	1	820 $\mu$ H	Würth	750316244	Würth	750316244	Yes
Q1	1	NDD05N50ZT4G	ON Semiconductor	NDD05N50ZT4G	ON Semiconductor	NDD05N50ZT4G	No
Q2	1	MMBT5551LT1G	ON Semiconductor	MMBT5551LT1G	ON Semiconductor	MMBT5551LT1G	No
RV1	1	MOV 130V	Littelfuse	V220ZA05P	Digikey	F3049-ND	Yes
Rdamp	1	220	Yageo	RSF200JB-73-220R	Digikey	220W-2-ND	Yes
Rsens	1	0.91	Yageo	PT1206FR-7W0R91L	Digikey	311-0.91APCT-ND	Yes
Rtco	1	680 PTC	Epcos	B59721A90A62	Digikey	495-4312-1-ND	Yes
R15	1	10	Yageo	RC1206FR-0710RL	Digikey	311-10.0FRCT-ND	Yes
R27	1	10k	Yageo	RC0603FR-0710k0L	Digikey	311-10.0KHRCT-ND	Yes
R29	1	412k	Yageo	RC1206FR-07412KL	Digikey	311-412KFRCT-ND	Yes
R36	1	301k	Yageo	RC0603FR-07301KL	Digikey	311-301KHRCT-ND	Yes
R37	1	100k	Yageo	RC0603FR-07100KL	Digikey	311-100KHRCT-ND	Yes
R38	1	220k	Yageo	RC1206FR-07220KL	Digikey	311-220KFRCT-ND	Yes
U2	1	NCL30073	ON Semiconductor	NCL30073	ON Semiconductor	NCL30073	No

NOTE: All components to comply with RoHS 2002/95/EC

# NCL30073LED3GEVB

## GERBER VIEWS

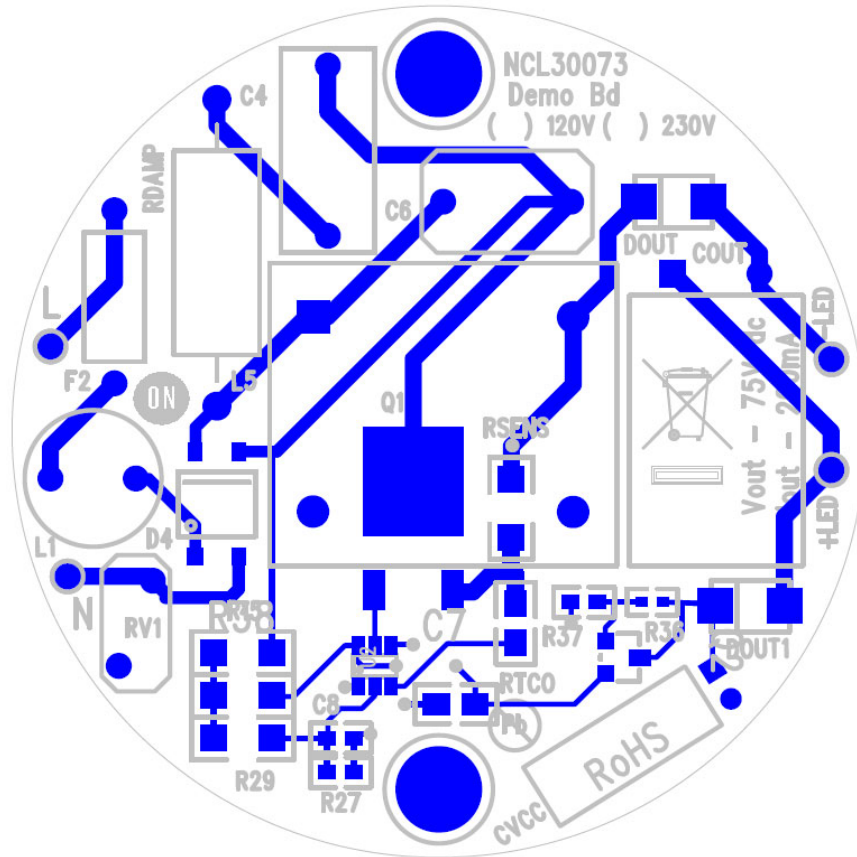

Figure 5. Top Side PCB

# NCL30073LED3GEVB

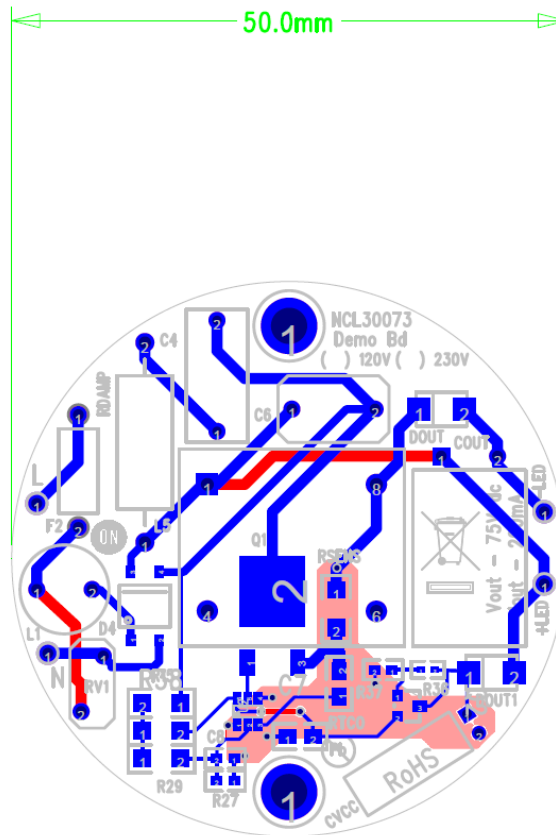

Figure 6. PCB Outline

## Circuit Board Fabrication Notes

1. Fabricate per IPC-6011 and IPC6012. Inspect to IPA-A-600 Class 2 or updated standard.
2. Printed Circuit Board is defined by files listed in fileset.
3. Modification to copper within the PCB outline is not allowed without permission, except where noted otherwise. The manufacturer may make adjustments to compensate for manufacturing process, but the final PCB is required to reflect the associated gerber file design  $\pm 0.001$  in. for etched features within the PCB outline.
4. Material in accordance with IPC-4101/21, FR4, Tg 125°C min.
5. Layer to layer registration shall not exceed  $\pm 0.004$  in.
6. External finished copper conductor thickness shall be 0.0026 in. min. (ie 2oz)
7. Copper plating thickness for through holes shall be 0.0013 in. min. (ie 1oz)
8. All holes sizes are finished hole size.
9. Finished PCB thickness 0.062 in.
10. All un-dimensioned holes to be drilled using the NC drill data.
11. Size tolerance of plated holes:  $\pm 0.003$  in. : non-plated holes  $\pm 0.002$  in.
12. All holes shall be  $\pm 0.003$  in. of their true position U.D.S.
13. Construction to be SMOBC, using liquid photo image (LPI) solder mask in accordance with IPC-SM-B40C, Type B, Class 2, and be green in color.
14. Solder mask mis-registration  $\pm 0.004$  in. max.
15. Silkscreen shall be permanent non-conductive white ink.
16. The fabrication process shall be UL approved and the PCB shall have a flammability rating of UL94V0 to be marked on the solder side in silkscreen with date, manufactures approved logo, and type designation.
17. Warp and twist of the PCB shall not exceed 0.0075 in. per in.
18. 100% electrical verification required.
19. Surface finish: electroless nickel immersion gold (ENIG)
20. RoHS 2002/95/EC compliance required.

# NCL30073LED3GEVB

## ECA PICTURES

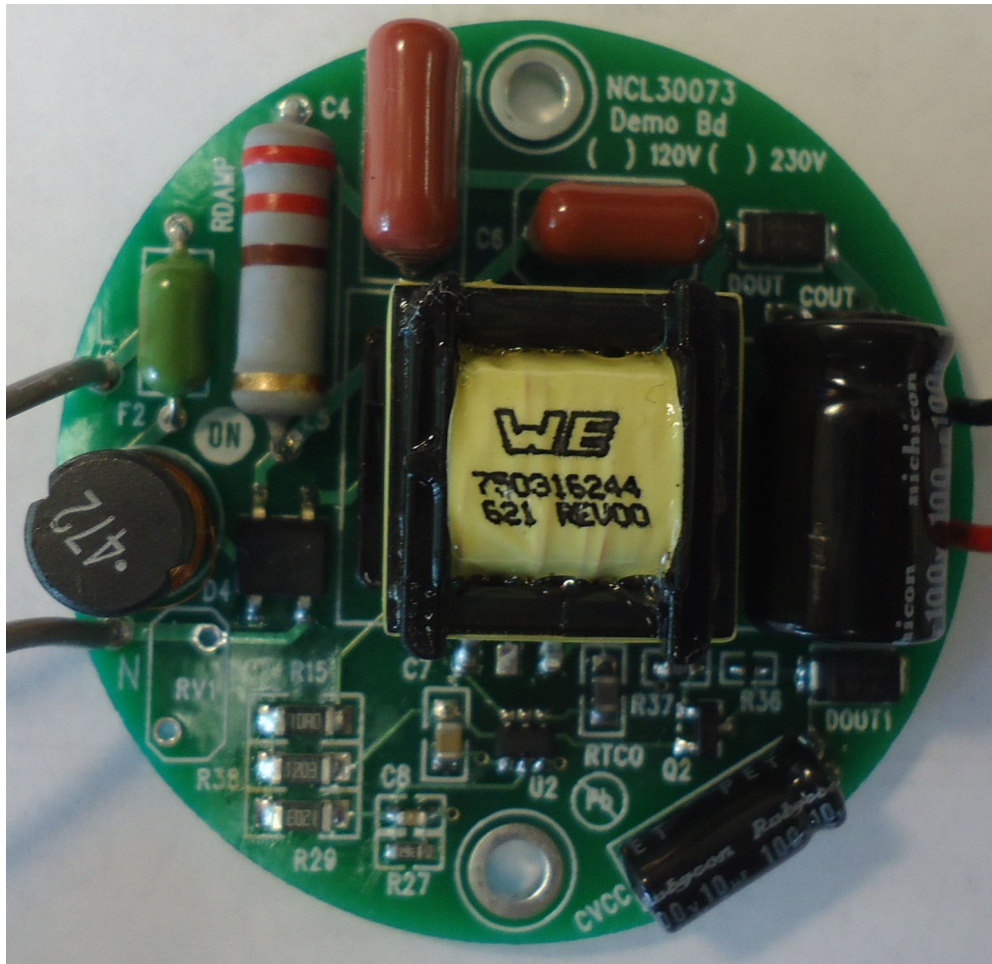

Figure 7. Top View

# NCL30073LED3GEVB

## TEST PROCEDURE

### Equipment Needed

- AC Source – 90 to 140 V ac 60 Hz Minimum 100 W capability
- AC Wattmeter – 100 W Minimum, True RMS Input Voltage, Current, Power Factor, and THD 0.2% accuracy or better
- DC Voltmeter – 300 V dc minimum 0.1% accuracy or better
- DC Ammeter – 1 A dc minimum 0.1% accuracy or better
- LED Load – 70 V – 80 V @ 110 mA

### Test Connections

1. Connect the LED Load to the red(+) and black(-) leads through the ammeter shown in Figure 10.  
**Caution: Observe the correct polarity or the load may be damaged.**
2. Connect the AC power to the input of the AC wattmeter shown in Figure 8. Connect the white leads to the output of the AC wattmeter
3. Connect the DC voltmeter as shown in Figure 8.

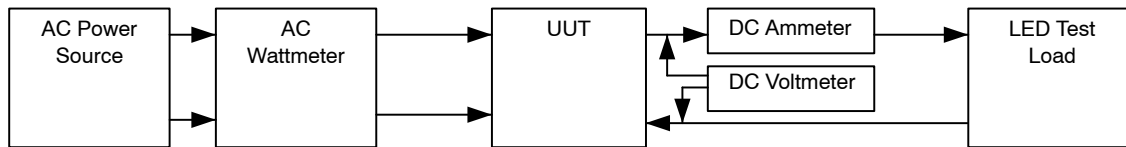

Note: Unless otherwise specified, all voltage measurements are taken at the terminals of the UUT.

Figure 8. Test Set Up

### Functional Test Procedure

1. Set the LED Load for 75 V output.
2. Set the input power to 120 V 60 Hz.

**Caution: Do not touch the ECA once it is energized because there are hazardous voltages present.**

### Regulation

120 V / Max Load

Table 3.

	Output Current	Output Power	Power Factor	THD
108 V				
120 V				
132 V				

$$\text{Efficiency} = \frac{V_{\text{out}} \times I_{\text{out}}}{P_{\text{in}}} \times 100\%$$



# NCL30073LED3GEVB

## TEST DATA

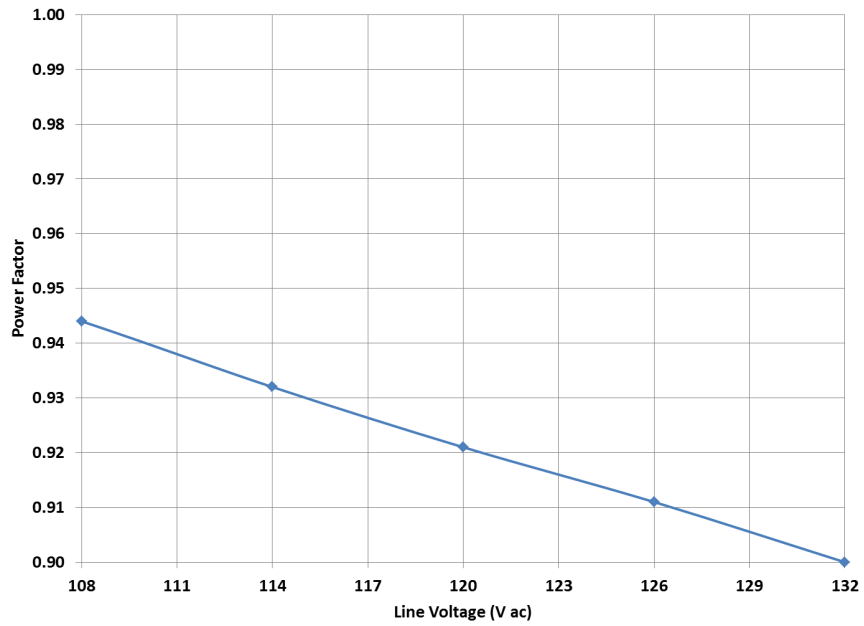

Figure 9. Power Factor Over Line

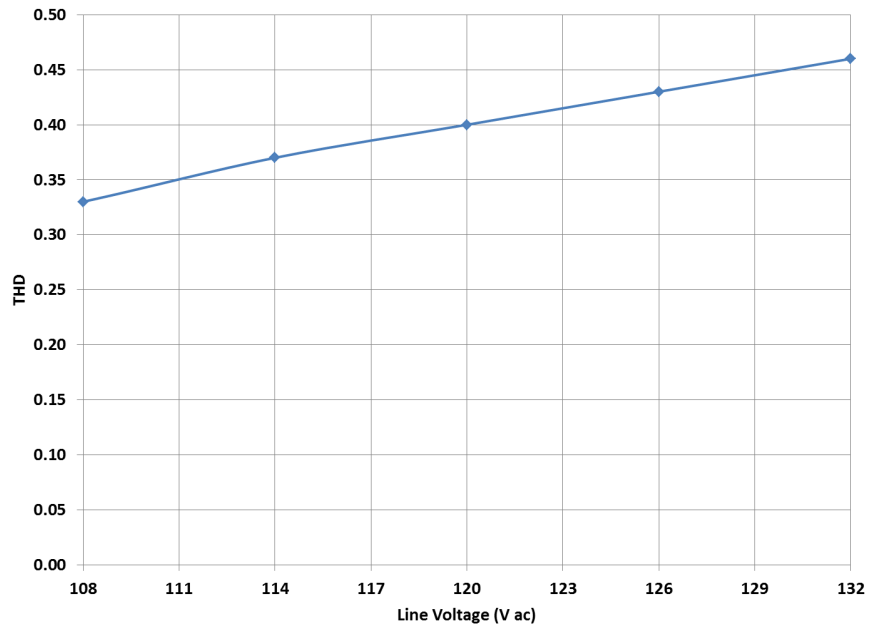

Figure 10. THD Over Line

# NCL30073LED3GEVB

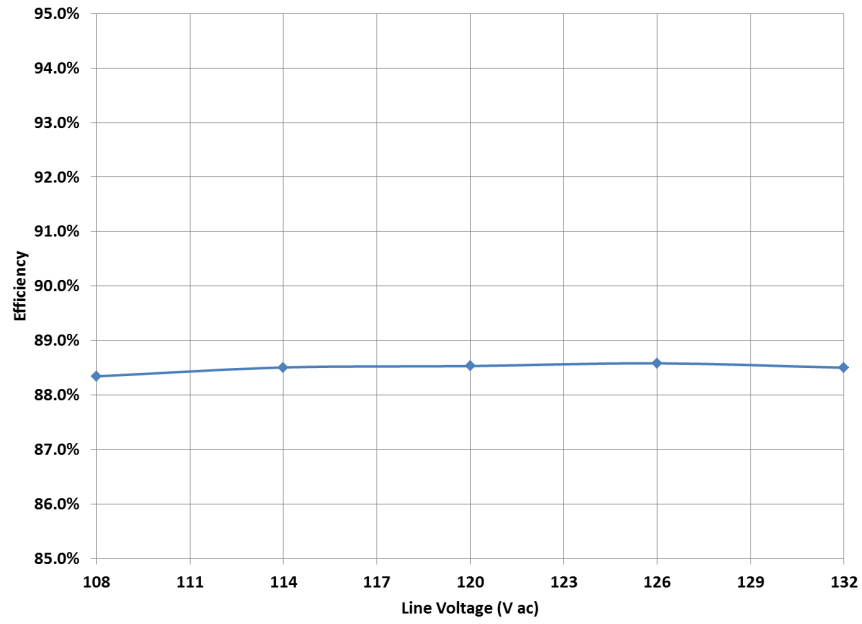

Figure 11. Efficiency

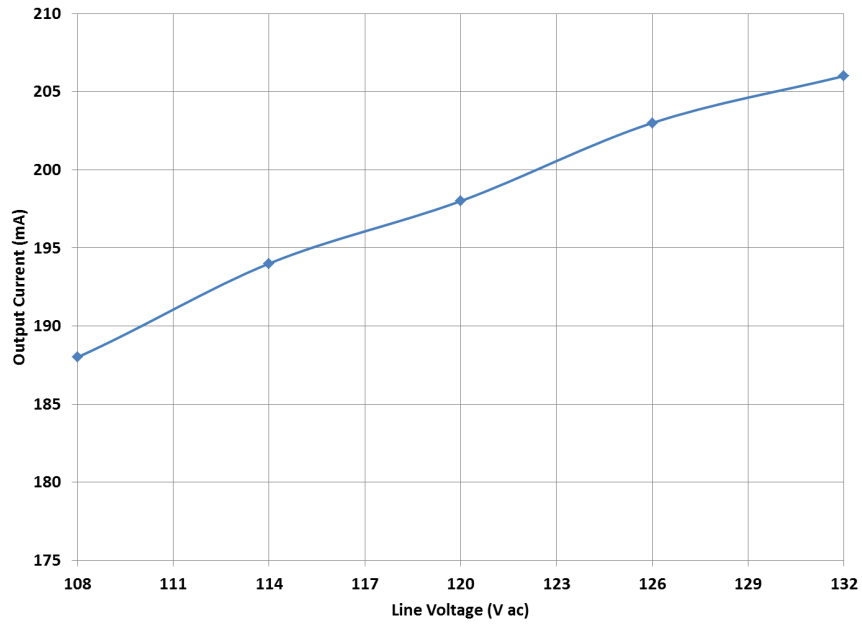

Figure 12. Regulation Over Line

# NCL30073LED3GEVB

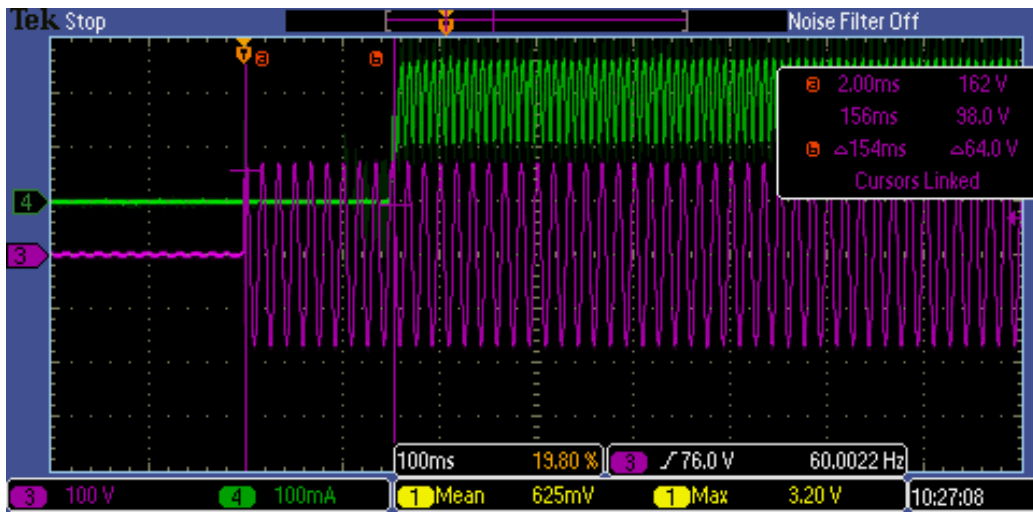

Figure 13. Start Up with AC Applied 120 V



Figure 14. Output Ripple 75% Pk - Pk

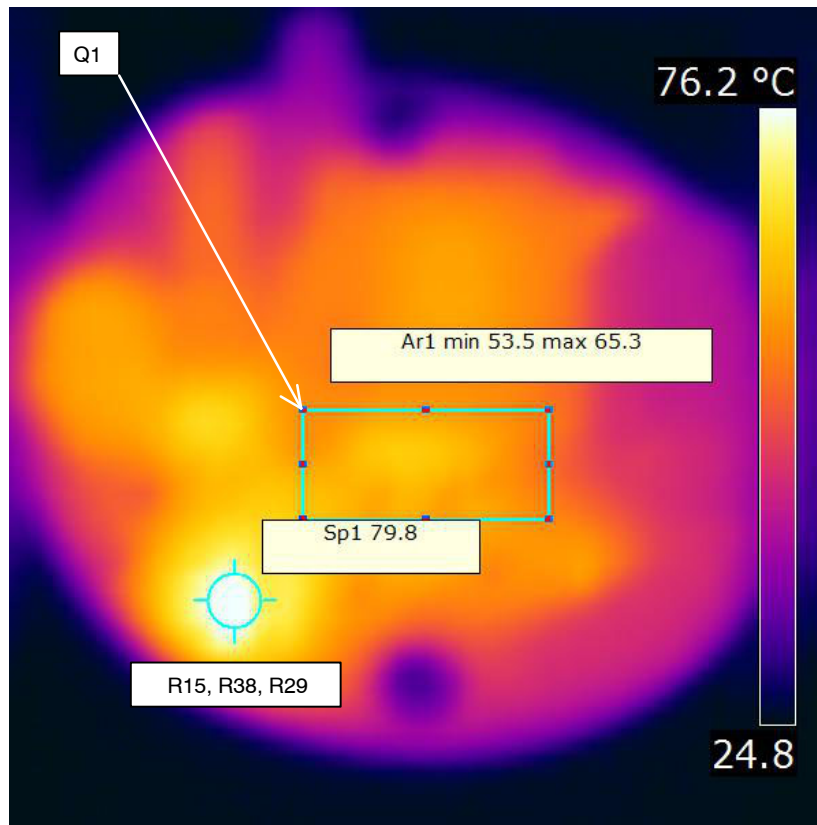

Figure 15. Thermal Image SMT Side

ON Semiconductor and the ON Semiconductor logo are trademarks of Semiconductor Components Industries, LLC dba ON Semiconductor or its subsidiaries in the United States and/or other countries. ON Semiconductor owns the rights to a number of patents, trademarks, copyrights, trade secrets, and other intellectual property. A listing of ON Semiconductor's product/patent coverage may be accessed at [www.onsemi.com/site/pdf/Patent-Marking.pdf](http://www.onsemi.com/site/pdf/Patent-Marking.pdf). ON Semiconductor is an Equal Opportunity/Affirmative Action Employer. This literature is subject to all applicable copyright laws and is not for resale in any manner.

The evaluation board/kit (research and development board/kit) (hereinafter the "board") is not a finished product and is as such not available for sale to consumers. The board is only intended for research, development, demonstration and evaluation purposes and should as such only be used in laboratory/development areas by persons with an engineering/technical training and familiar with the risks associated with handling electrical/mechanical components, systems and subsystems. This person assumes full responsibility/liability for proper and safe handling. Any other use, resale or redistribution for any other purpose is strictly prohibited.

The board is delivered "AS IS" and without warranty of any kind including, but not limited to, that the board is production-worthy, that the functions contained in the board will meet your requirements, or that the operation of the board will be uninterrupted or error free. ON Semiconductor expressly disclaims all warranties, express, implied or otherwise, including without limitation, warranties of fitness for a particular purpose and non-infringement of intellectual property rights.

ON Semiconductor reserves the right to make changes without further notice to any board.

You are responsible for determining whether the board will be suitable for your intended use or application or will achieve your intended results. Prior to using or distributing any systems that have been evaluated, designed or tested using the board, you agree to test and validate your design to confirm the functionality for your application. Any technical, applications or design information or advice, quality characterization, reliability data or other services provided by ON Semiconductor shall not constitute any representation or warranty by ON Semiconductor, and no additional obligations or liabilities shall arise from ON Semiconductor having provided such information or services.

The boards are not designed, intended, or authorized for use in life support systems, or any FDA Class 3 medical devices or medical devices with a similar or equivalent classification in a foreign jurisdiction, or any devices intended for implantation in the human body. Should you purchase or use the board for any such unintended or unauthorized application, you shall indemnify and hold ON Semiconductor and its officers, employees, subsidiaries, affiliates, and distributors harmless against all claims, costs, damages, and expenses, and reasonable attorney fees arising out of, directly or indirectly, any claim of personal injury or death associated with such unintended or unauthorized use, even if such claim alleges that ON Semiconductor was negligent regarding the design or manufacture of the board.

This evaluation board/kit does not fall within the scope of the European Union directives regarding electromagnetic compatibility, restricted substances (RoHS), recycling (WEEE), FCC, CE or UL, and may not meet the technical requirements of these or other related directives.

**FCC WARNING** – This evaluation board/kit is intended for use for engineering development, demonstration, or evaluation purposes only and is not considered by ON Semiconductor to be a finished end product fit for general consumer use. It may generate, use, or radiate radio frequency energy and has not been tested for compliance with the limits of computing devices pursuant to part 15 of FCC rules, which are designed to provide reasonable protection against radio frequency interference. Operation of this equipment may cause interference with radio communications, in which case the user shall be responsible, at its expense, to take whatever measures may be required to correct this interference.

ON Semiconductor does not convey any license under its patent rights nor the rights of others.

**LIMITATIONS OF LIABILITY:** ON Semiconductor shall not be liable for any special, consequential, incidental, indirect or punitive damages, including, but not limited to the costs of requalification, delay, loss of profits or goodwill, arising out of or in connection with the board, even if ON Semiconductor is advised of the possibility of such damages. In no event shall ON Semiconductor's aggregate liability from any obligation arising out of or in connection with the board, under any theory of liability, exceed the purchase price paid for the board, if any.

For more information and documentation, please visit [www.onsemi.com](http://www.onsemi.com).

---

## PUBLICATION ORDERING INFORMATION

### LITERATURE FULFILLMENT:

Email Requests to: [orderlit@onsemi.com](mailto:orderlit@onsemi.com)

ON Semiconductor Website: [www.onsemi.com](http://www.onsemi.com)

### TECHNICAL SUPPORT

North American Technical Support:

Voice Mail: 1 800-282-9855 Toll Free USA/Canada

Phone: 011 421 33 790 2910

Europe, Middle East and Africa Technical Support:

Phone: 00421 33 790 2910

For additional information, please contact your local Sales Representative