

ISL9R460PF2

4 A, 600 V, STEALTH™ Diode

Description

The ISL9R460PF2 is a STEALTH diode optimized for low loss performance in high frequency hard switched applications. The STEALTH family exhibits low reverse recovery current (I_{RR}) and exceptionally soft recovery under typical operating conditions. This device is intended for use as a free wheeling or boost diode in power supplies and other power switching applications. The low I_{RR} and short t_a phase reduce loss in switching transistors. The soft recovery minimizes ringing, expanding the range of conditions under which the diode may be operated without the use of additional snubber circuitry. Consider using the STEALTH diode with an SMPS IGBT to provide the most efficient and highest power density design at lower cost.

Features

- Ultrafast Recovery, $t_{RR} = 17 \text{ ns}$ (@ $I_F = 4 \text{ A}$)
- Max Forward Voltage, $V_F = 2.4 \text{ V}$ (@ $T_C = 25^\circ\text{C}$)
- 600 V Reverse Voltage and High Reliability
- Avalanche Energy Rated
- This Device is Pb-Free and is RoHS Compliant

Applications

- SMPS
- Hard Switched PFC Boost Diode
- UPS Free Wheeling Diode
- Motor Drive FWD
- SMPS FWD
- Snubber Diode



ON Semiconductor®

www.onsemi.com

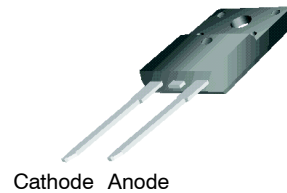

TO-220, 2-Lead
CASE 221AS

MARKING DIAGRAM

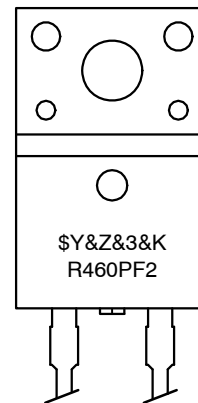

\$Y	= ON Semiconductor Logo
&Z&3	= Data Code (Year & Week)
&K	= Lot
R460PF2	= Specific Device Code

ORDERING INFORMATION

See detailed ordering and shipping information on page 2 of this data sheet.

ISL9R460PF2

DEVICE MAXIMUM RATINGS $T_C = 25^\circ\text{C}$ unless otherwise noted

Symbol	Parameter	Rating	Unit
V_{RRM}	Peak Repetitive Reverse Voltage	600	V
V_{RWM}	Working Peak Reverse Voltage	600	V
V_R	DC Blocking Voltage	600	V
$I_{F(AV)}$	Average Rectified Forward Current ($T_C = 108^\circ\text{C}$)	4	A
I_{FRM}	Repetitive Peak Surge Current (20 kHz Square Wave)	8	A
I_{FSM}	Nonrepetitive Peak Surge Current (Halfwave 1 Phase 60 Hz)	50	A
P_D	Power Dissipation	22	W
E_{AVL}	Avalanche Energy (0.5 A, 80 mH)	10	mJ
T_J, T_{STG}	Operating and Storage Temperature Range	-55 to 175	$^\circ\text{C}$
T_L, T_{PKG}	Maximum Temperature for Soldering Leads at 0.063in (1.6 mm) from Case for 10s Package Body for 10s, See Techbrief TB334	300 260	$^\circ\text{C}$ $^\circ\text{C}$

Stresses exceeding those listed in the Maximum Ratings table may damage the device. If any of these limits are exceeded, device functionality should not be assumed, damage may occur and reliability may be affected.

PACKAGE MARKING AND ORDERING INFORMATION

Part Number	Top Mark	Package	Packing Method	Reel Size	Tape Width	Quantity
ISL9R460PF2	R460PF2	TO-220F-2L	Tube	N/A	N/A	50

ELECTRICAL CHARACTERISTICS $T_C = 25^\circ\text{C}$ unless otherwise noted

Parameter	Conditions	Min	Typ	Max	Unit
-----------	------------	-----	-----	-----	------

OFF STATE CHARACTERISTICS

I_R	Instantaneous Reverse Current	$V_R = 600\text{ V}$	$T_C = 25^\circ\text{C}$	-	-	100	μA
			$T_C = 125^\circ\text{C}$	-	-	1.0	mA

ON STATE CHARACTERISTICS

V_F	Instantaneous Forward Voltage	$I_F = 4\text{ A}$	$T_C = 25^\circ\text{C}$	-	2.0	2.4	V
			$T_C = 125^\circ\text{C}$	-	1.6	2.0	V

DYNAMIC CHARACTERISTICS

C_J	Junction Capacitance	$V_R = 10\text{ V}, I_F = 0\text{ A}$	-	19	-	pF
-------	----------------------	---------------------------------------	---	----	---	----

SWITCHING CHARACTERISTICS

t_{RR}	Reverse Recovery Time	$I_F = 1\text{ A}, di_F/dt = 100\text{ A}/\mu\text{s}, V_R = 30\text{ V}$	-	17	20	ns
		$I_F = 4\text{ A}, di_F/dt = 100\text{ A}/\mu\text{s}, V_R = 30\text{ V}$	-	19	22	ns
t_{RR}	Reverse Recovery Time	$I_F = 4\text{ A}, di_F/dt = 200\text{ A}/\mu\text{s}, V_R = 390\text{ V}, T_C = 25^\circ\text{C}$	-	17	-	ns
I_{RR}	Reverse Recovery Current		-	2.6	-	A
Q_{RR}	Reverse Recovered Charge		-	22	-	nC
t_{RR}	Reverse Recovery Time		-	77	-	ns
S	Softness Factor (t_b/t_a)	$I_F = 4\text{ A}, di_F/dt = 200\text{ A}/\mu\text{s}, V_R = 390\text{ V}, T_C = 125^\circ\text{C}$	-	4.2	-	
I_{RR}	Reverse Recovery Current		-	2.8	-	A
Q_{RR}	Reverse Recovered Charge		-	100	-	nC

ISL9R460PF2

ELECTRICAL CHARACTERISTICS $T_C = 25^\circ\text{C}$ unless otherwise noted (continued)

Parameter	Conditions	Min	Typ	Max	Unit
SWITCHING CHARACTERISTICS					
t_{RR}	Reverse Recovery Time		54		ns
S	Softness Factor (t_b/t_a)		3.5		
I_{RR}	Reverse Recovery Current		4.3		A
Q_{RR}	Reverse Recovered Charge		110		nC
di_M/dt	Maximum di/dt during t_b		500		A/ μs
$I_F = 4\text{ A}$, $di_F/dt = 400\text{ A}/\mu\text{s}$, $V_R = 390\text{ V}$, $T_C = 125^\circ\text{C}$					

THERMAL CHARACTERISTICS

$R_{\theta JC}$	Thermal Resistance Junction to Case			5.7	$^\circ\text{C}/\text{W}$
$R_{\theta JA}$	Thermal Resistance Junction to Ambient	TO-220F		70	$^\circ\text{C}/\text{W}$

Product parametric performance is indicated in the Electrical Characteristics for the listed test conditions, unless otherwise noted. Product performance may not be indicated by the Electrical Characteristics if operated under different conditions.

TYPICAL PERFORMANCE CURVES

$T_C = 25^\circ\text{C}$ unless otherwise noted

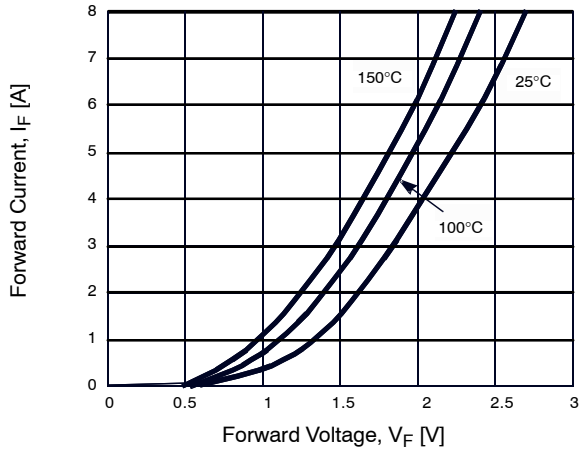

Figure 1. Forward Current vs Forward Voltage

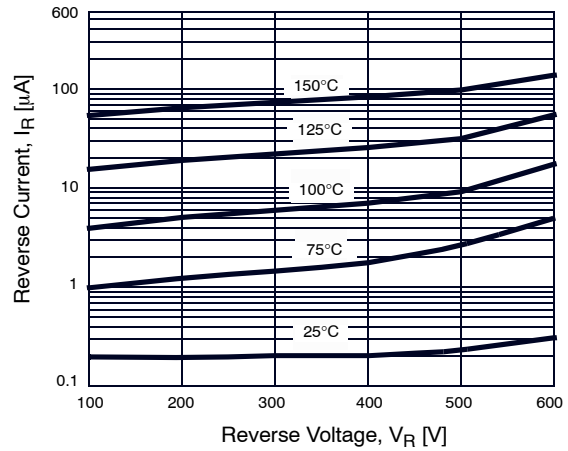

Figure 2. Reverse Current vs Reverse Voltage

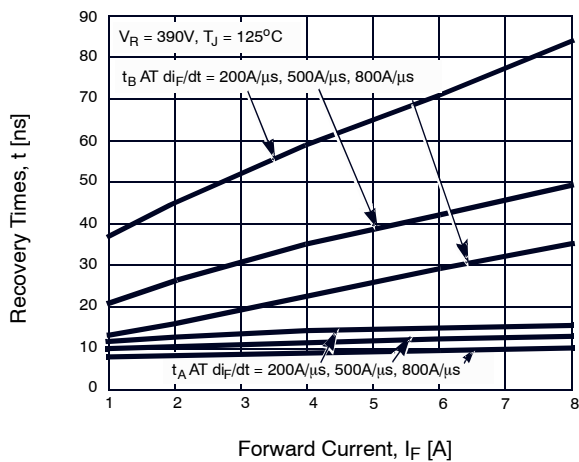

Figure 3. t_A and t_B Curves vs Forward Current

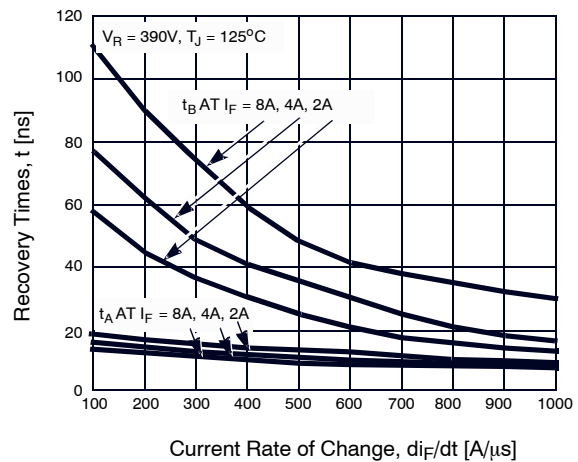

Figure 4. t_A and t_B Curves vs di_F/dt

ISL9R460PF2

TYPICAL PERFORMANCE CURVES (continued)

$T_C = 25^\circ\text{C}$ unless otherwise noted

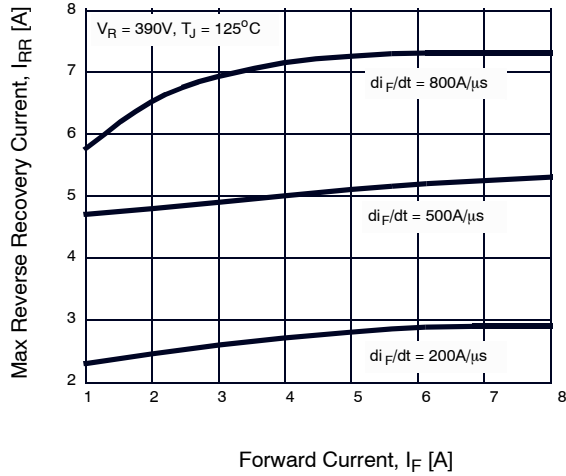

Figure 5. Maximum Reverse Recovery Current vs Forward Current

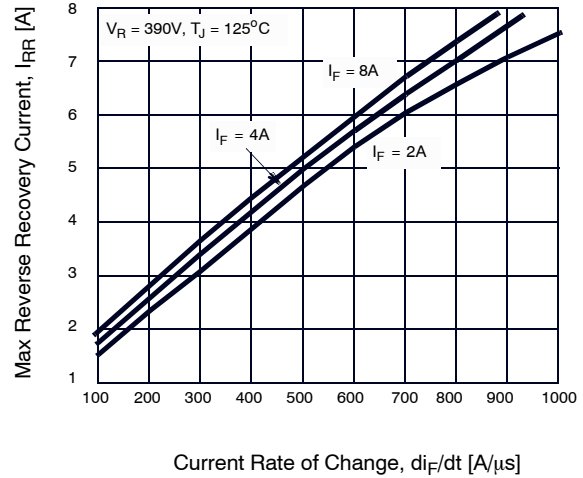

Figure 6. Maximum Reverse Recovery Current vs di_F/dt

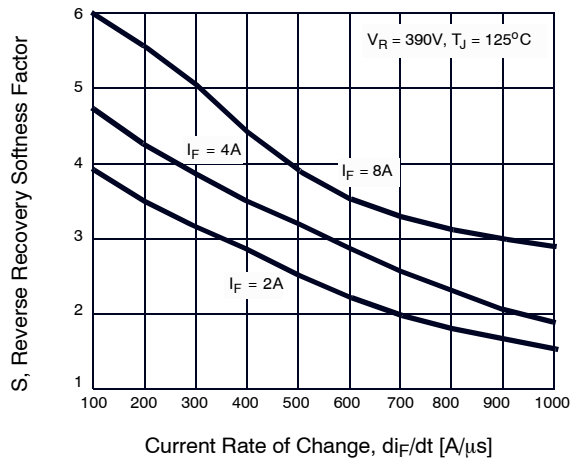

Figure 7. Reverse Recovery Softness vs di_F/dt

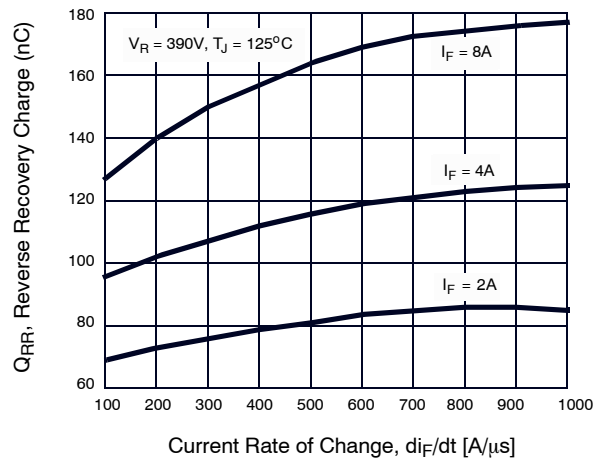

Figure 8. Reverse Recovery Charge vs di_F/dt

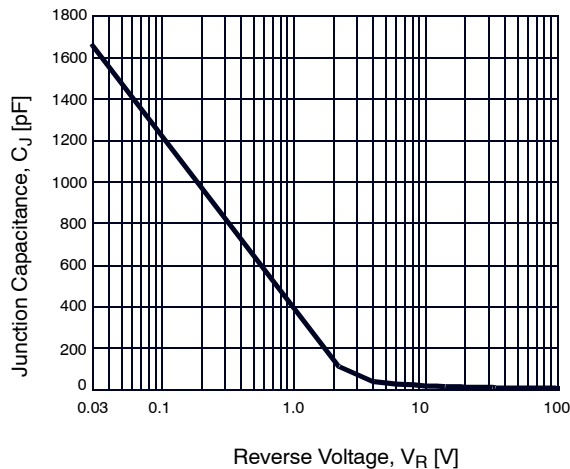

Figure 9. Junction Capacitance vs Reverse Voltage

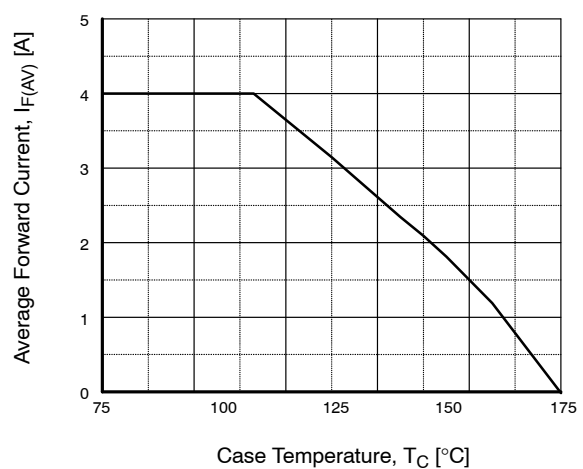

Figure 10. DC Current Derating Curve

ISL9R460PF2

TYPICAL PERFORMANCE CURVES (continued)

$T_C = 25^\circ\text{C}$ unless otherwise noted

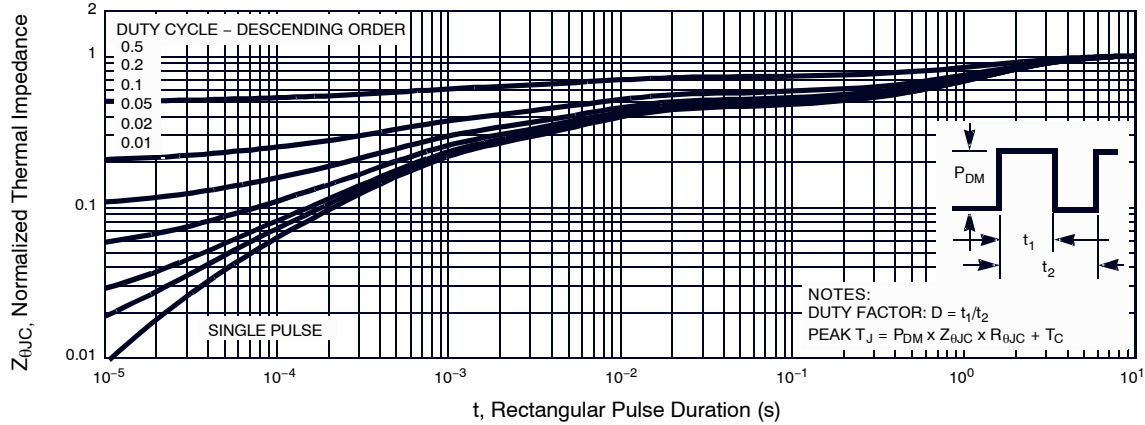

Figure 11. Normalized Maximum Transient Thermal Impedance

TEST CIRCUIT AND WAVEFORMS

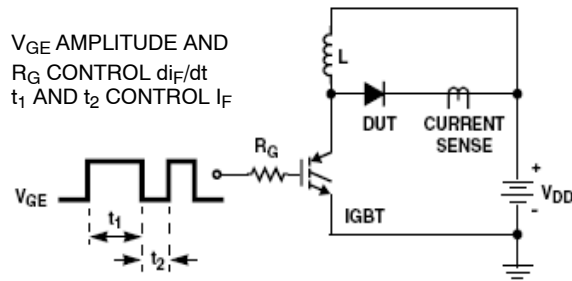

Figure 12. I_{tRR} Test Circuit

$I = 0.5 \text{ A}$
 $L = 80 \text{ mH}$
 $R < 0.1 \Omega$
 $V_{DD} = 200 \text{ V}$
 $E_{AVL} = 1/2LI^2[V_{R(AVL)} / (V_{R(AVL)} - V_{DD})]$
 $Q_1 = \text{IGBT (} B_{VCEs} > \text{DUT } V_{R(AVL)})$

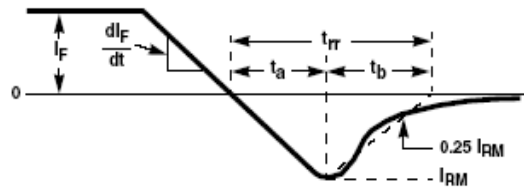

Figure 13. t_{RR} Waveforms and Definitions

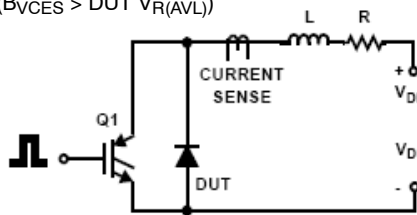

Figure 14. Avalanche Energy Test Circuit

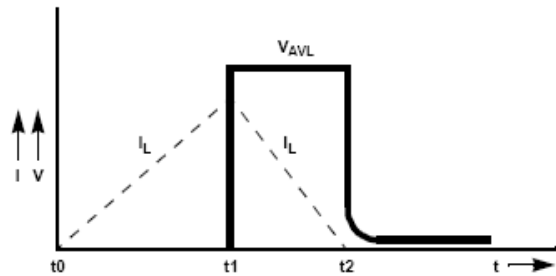
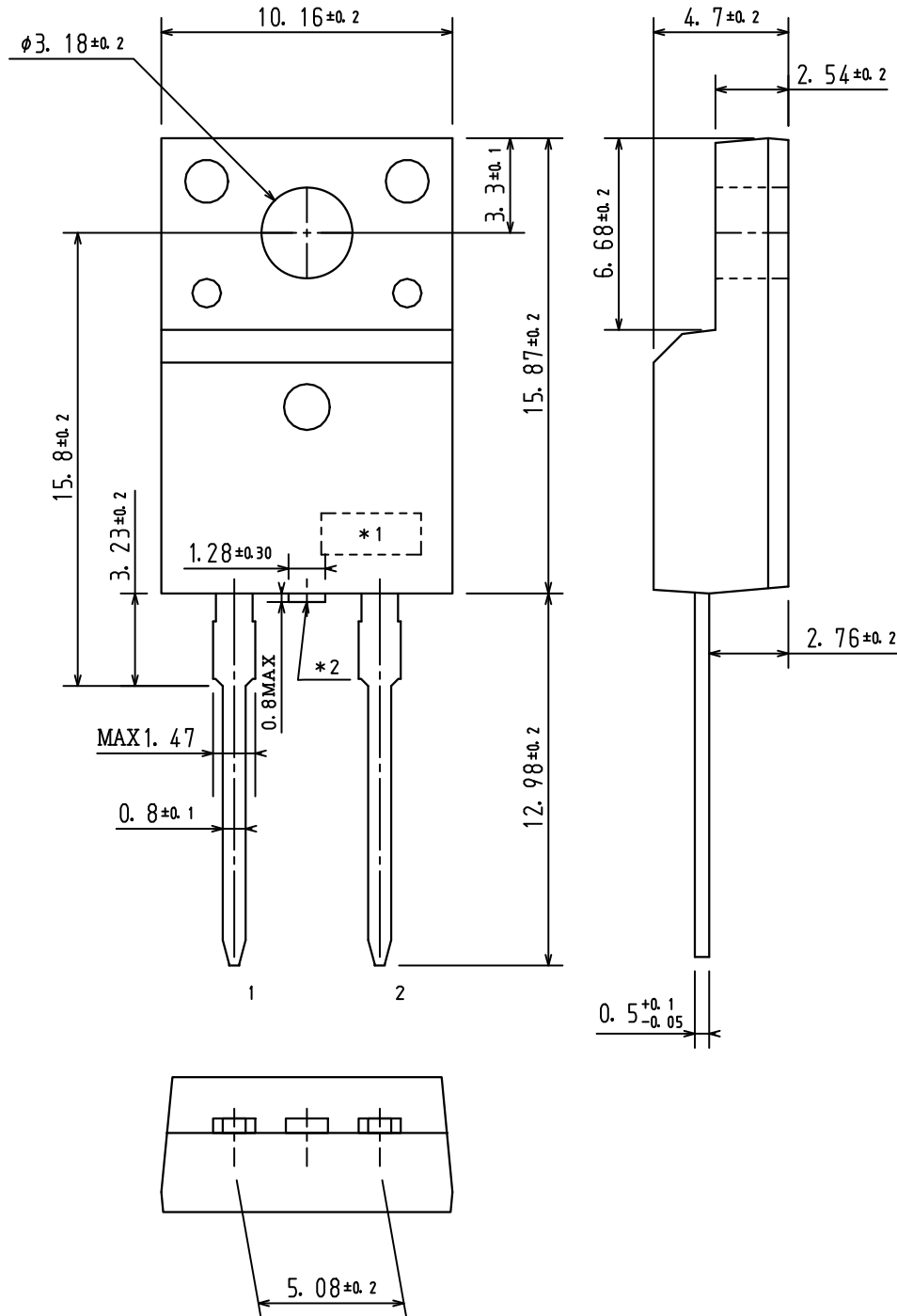

Figure 15. Avalanche Current and Voltage Waveforms

MECHANICAL CASE OUTLINE
PACKAGE DIMENSIONS

TO-220 Fullpack, 2-Lead / TO-220F-2FS
CASE 221AS
ISSUE 0

DATE 29 FEB 2012



DOCUMENT NUMBER:	98AON67438E	Electronic versions are uncontrolled except when accessed directly from the Document Repository. Printed versions are uncontrolled except when stamped "CONTROLLED COPY" in red.
STATUS:	ON SEMICONDUCTOR STANDARD	
NEW STANDARD:		
DESCRIPTION:	TO-220 FULLPACK, 2-LEAD / TO-220F-2FS	PAGE 1 OF 2

ON Semiconductor and  are trademarks of Semiconductor Components Industries, LLC dba ON Semiconductor or its subsidiaries in the United States and/or other countries. ON Semiconductor owns the rights to a number of patents, trademarks, copyrights, trade secrets, and other intellectual property. A listing of ON Semiconductor's product/patent coverage may be accessed at www.onsemi.com/site/pdf/Patent-Marking.pdf. ON Semiconductor reserves the right to make changes without further notice to any products herein. ON Semiconductor makes no warranty, representation or guarantee regarding the suitability of its products for any particular purpose, nor does ON Semiconductor assume any liability arising out of the application or use of any product or circuit, and specifically disclaims any and all liability, including without limitation special, consequential or incidental damages. Buyer is responsible for its products and applications using ON Semiconductor products, including compliance with all laws, regulations and safety requirements or standards, regardless of any support or applications information provided by ON Semiconductor. "Typical" parameters which may be provided in ON Semiconductor data sheets and/or specifications can and do vary in different applications and actual performance may vary over time. All operating parameters, including "Typicals" must be validated for each customer application by customer's technical experts. ON Semiconductor does not convey any license under its patent rights nor the rights of others. ON Semiconductor products are not designed, intended, or authorized for use as a critical component in life support systems or any FDA Class 3 medical devices or medical devices with a same or similar classification in a foreign jurisdiction or any devices intended for implantation in the human body. Should Buyer purchase or use ON Semiconductor products for any such unintended or unauthorized application, Buyer shall indemnify and hold ON Semiconductor and its officers, employees, subsidiaries, affiliates, and distributors harmless against all claims, costs, damages, and expenses, and reasonable attorney fees arising out of, directly or indirectly, any claim of personal injury or death associated with such unintended or unauthorized use, even if such claim alleges that ON Semiconductor was negligent regarding the design or manufacture of the part. ON Semiconductor is an Equal Opportunity/Affirmative Action Employer. This literature is subject to all applicable copyright laws and is not for resale in any manner.

PUBLICATION ORDERING INFORMATION

LITERATURE FULFILLMENT:

Literature Distribution Center for ON Semiconductor
19521 E. 32nd Pkwy, Aurora, Colorado 80011 USA
Phone: 303-675-2175 or 800-344-3860 Toll Free USA/Canada
Fax: 303-675-2176 or 800-344-3867 Toll Free USA/Canada
Email: orderlit@onsemi.com

N. American Technical Support: 800-282-9855 Toll Free
USA/Canada
Europe, Middle East and Africa Technical Support:
Phone: 421 33 790 2910

ON Semiconductor Website: www.onsemi.com

Order Literature: <http://www.onsemi.com/orderlit>

For additional information, please contact your local
Sales Representative