

40A, 600V, UFS Series N-Channel IGBT with Anti-Parallel Hyperfast Diode

The HGTG20N60B3D is a MOS gated high voltage switching device combining the best features of MOSFETs and bipolar transistors. The device has the high input impedance of a MOSFET and the low on-state conduction loss of a bipolar transistor. The much lower on-state voltage drop varies only moderately between 25°C and 150°C. The diode used in anti-parallel with the IGBT is the RHRP3060.

The IGBT is ideal for many high voltage switching applications operating at moderate frequencies where low conduction losses are essential.

Formerly developmental type TA49016.

Ordering Information

PART NUMBER	PACKAGE	BRAND
HGTG20N60B3D	TO-247	G20N60B3D

NOTE: When ordering, use the entire part number.

Symbol

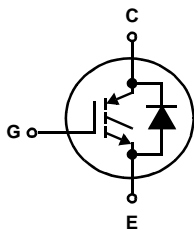

Features

- 40A, 600V at $T_C = 25^\circ\text{C}$
- Typical Fall Time. 140ns at 150°C
- Short Circuit Rated
- Low Conduction Loss
- Hyperfast Anti-Parallel Diode

Packaging

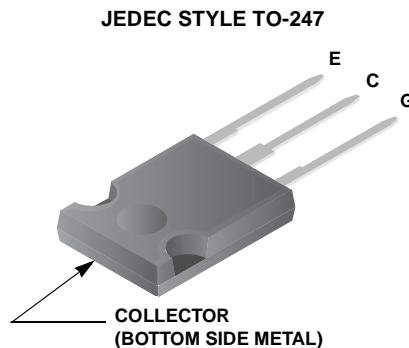

HGTG20N60B3D

Absolute Maximum Ratings $T_C = 25^\circ\text{C}$, Unless Otherwise Specified

	HGTG20N60B3D	UNITS
Collector to Emitter Voltage	600	V
Collector to Gate Voltage, $R_{GE} = 1\text{M}\Omega$	600	V
Collector Current Continuous	40	A
At $T_C = 110^\circ\text{C}$	20	A
Average Diode Forward Current at 110°C	20	A
Collector Current Pulsed (Note 1)	160	A
Gate to Emitter Voltage Continuous	± 20	V
Gate to Emitter Voltage Pulsed	± 30	V
Switching Safe Operating Area at $T_C = 150^\circ\text{C}$	30A at 600V	
Power Dissipation Total at $T_C = 25^\circ\text{C}$	165	W
Power Dissipation Derating $T_C > 25^\circ\text{C}$	1.32	W/ $^\circ\text{C}$
Operating and Storage Junction Temperature Range	-40 to 150	$^\circ\text{C}$
Maximum Lead Temperature for Soldering	260	$^\circ\text{C}$
Short Circuit Withstand Time (Note 2) at $V_{GE} = 15\text{V}$	4	μs
Short Circuit Withstand Time (Note 2) at $V_{GE} = 10\text{V}$	10	μs

CAUTION: Stresses above those listed in "Absolute Maximum Ratings" may cause permanent damage to the device. This is a stress only rating and operation of the device at these or any other conditions above those indicated in the operational sections of this specification is not implied.

NOTES:

1. Repetitive Rating: Pulse width limited by maximum junction temperature.
2. $V_{CE} = 360\text{V}$, $T_C = 125^\circ\text{C}$, $R_G = 25\Omega$.

Electrical Specifications $T_C = 25^\circ\text{C}$, Unless Otherwise Specified

PARAMETER	SYMBOL	TEST CONDITIONS	MIN	TYP	MAX	UNITS	
Collector to Emitter Breakdown Voltage	BV_{CES}	$I_C = 250\mu\text{A}$, $V_{GE} = 0\text{V}$	600	-	-	V	
Collector to Emitter Leakage Current	I_{CES}	$V_{CE} = BV_{CES}$	$T_C = 25^\circ\text{C}$	-	-	250	μA
			$T_C = 150^\circ\text{C}$	-	-	2.0	mA
Collector to Emitter Saturation Voltage	$V_{CE(SAT)}$	$I_C = I_{C110}$, $V_{GE} = 15\text{V}$	$T_C = 25^\circ\text{C}$	-	1.8	2.0	V
			$T_C = 150^\circ\text{C}$	-	2.1	2.5	V
Gate to Emitter Threshold Voltage	$V_{GE(TH)}$	$I_C = 250\mu\text{A}$, $V_{CE} = V_{GE}$	3.0	5.0	6.0	V	
Gate to Emitter Leakage Current	I_{GES}	$V_{GE} = \pm 20\text{V}$	-	-	± 100	nA	
Switching SOA	SSOA	$T_C = 150^\circ\text{C}$, $V_{GE} = 15\text{V}$, $R_G = 10\Omega$, $L = 45\mu\text{H}$	$V_{CE} = 480\text{V}$	100	-	-	A
			$V_{CE} = 600\text{V}$	30	-	-	A
Gate to Emitter Plateau Voltage	V_{GEP}	$I_C = I_{C110}$, $V_{CE} = 0.5 BV_{CES}$	-	8.0	-	V	
On-State Gate Charge	$Q_{G(ON)}$	$I_C = I_{C110}$, $V_{CE} = 0.5 BV_{CES}$	$V_{GE} = 15\text{V}$	-	80	105	nC
			$V_{GE} = 20\text{V}$	-	105	135	nC
Current Turn-On Delay Time	$t_{d(ON)I}$	$T_C = 150^\circ\text{C}$, $I_{CE} = I_{C110}$, $V_{CE} = 0.8 BV_{CES}$, $V_{GE} = 15\text{V}$, $R_G = 10\Omega$, $L = 100\mu\text{H}$	-	25	-	ns	
Current Rise Time	t_{rI}		-	20	-	ns	
Current Turn-Off Delay Time	$t_{d(OFF)I}$		-	220	275	ns	
Current Fall Time	t_{fI}		-	140	175	ns	
Turn-On Energy	E_{ON}		-	475	-	μJ	
Turn-Off Energy (Note 3)	E_{OFF}		-	1050	-	μJ	
Diode Forward Voltage	V_{EC}	$I_{EC} = 20\text{A}$	-	1.5	1.9	V	
Diode Reverse Recovery Time	t_{rr}	$I_{EC} = 20\text{A}$, $dI_{EC}/dt = 100\text{A}/\mu\text{s}$	-	-	55	ns	
		$I_{EC} = 1\text{A}$, $dI_{EC}/dt = 100\text{A}/\mu\text{s}$	-	-	45	ns	
Thermal Resistance	$R_{\theta JC}$	IGBT	-	-	0.76	$^\circ\text{C}/\text{W}$	
		Diode	-	-	1.2	$^\circ\text{C}/\text{W}$	

NOTE:

3. Turn-Off Energy Loss (E_{OFF}) is defined as the integral of the instantaneous power loss starting at the trailing edge of the input pulse and ending at the point where the collector current equals zero ($I_{CE} = 0\text{A}$). The HGTG20N60B3D was tested per JEDEC standard No. 24-1 Method for Measurement of Power Device Turn-Off Switching Loss. This test method produces the true total Turn-Off Energy Loss. Turn-On losses include diode losses.

Typical Performance Curves

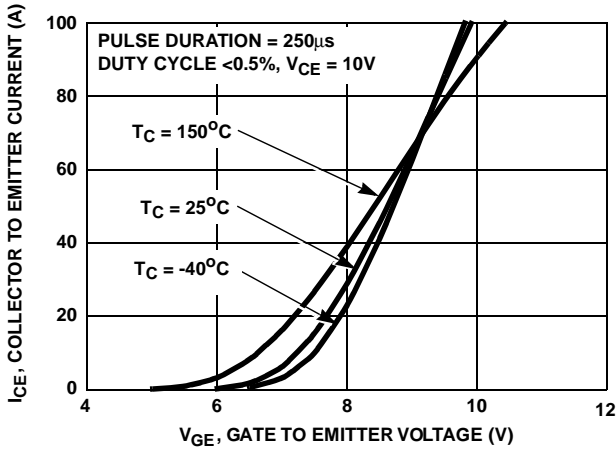

FIGURE 1. TRANSFER CHARACTERISTICS

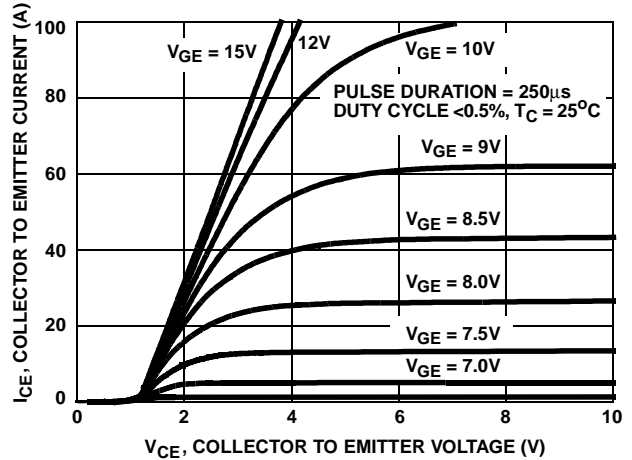

FIGURE 2. SATURATION CHARACTERISTICS

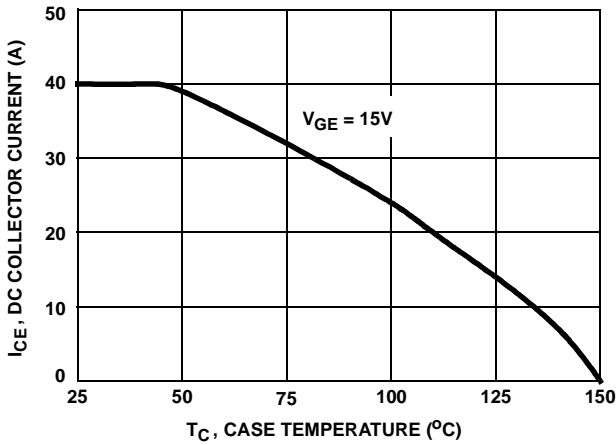

FIGURE 3. DC COLLECTOR CURRENT vs CASE TEMPERATURE

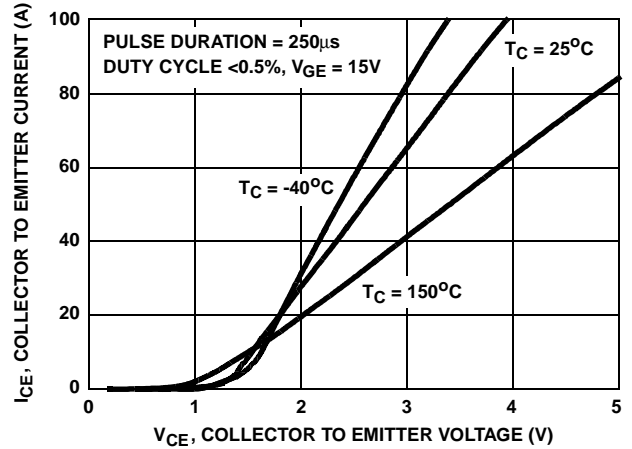

FIGURE 4. COLLECTOR TO EMITTER ON-STATE VOLTAGE

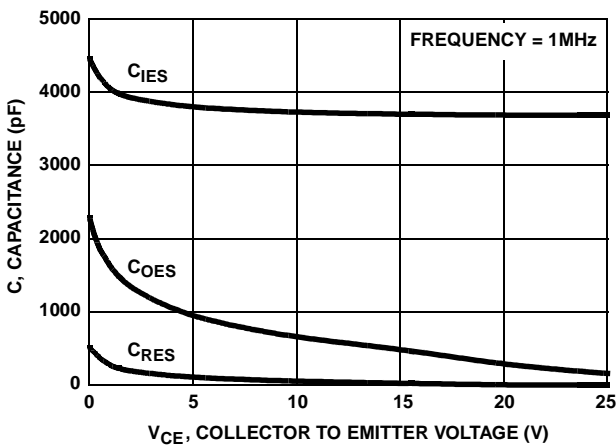

FIGURE 5. CAPACITANCE vs COLLECTOR TO EMITTER VOLTAGE

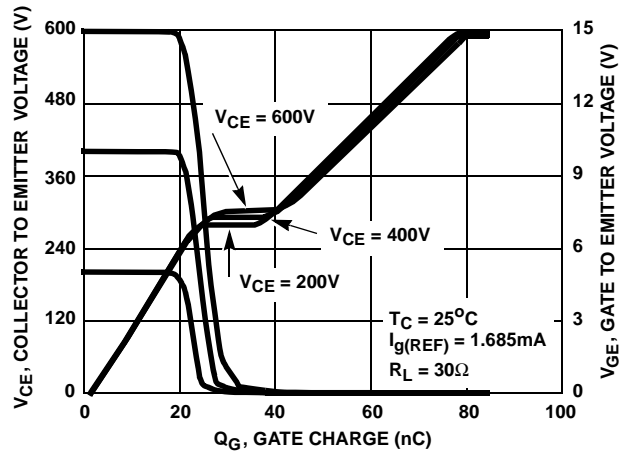

FIGURE 6. GATE CHARGE WAVEFORMS

Typical Performance Curves (Continued)

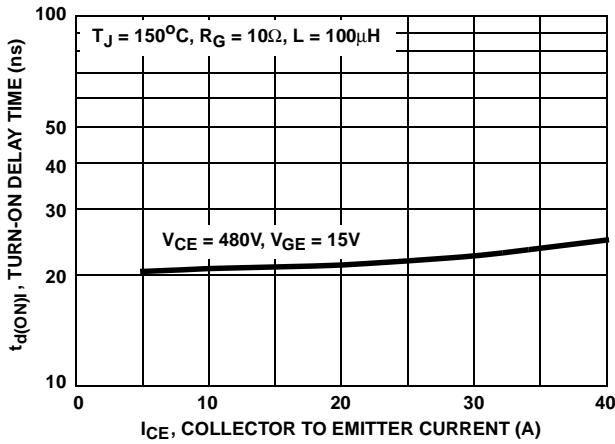

FIGURE 7. TURN-ON DELAY TIME vs COLLECTOR TO EMITTER CURRENT

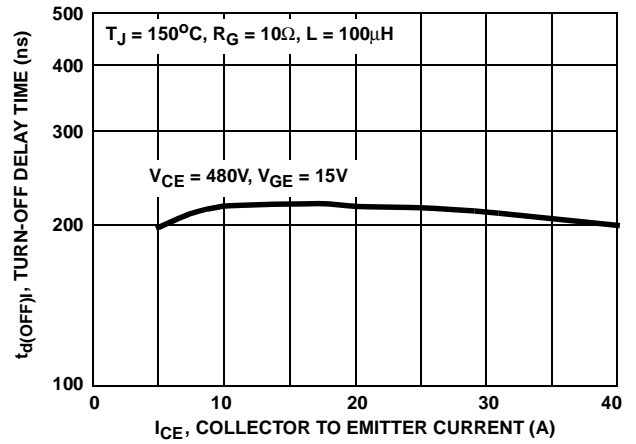

FIGURE 8. TURN-OFF DELAY TIME vs COLLECTOR TO EMITTER CURRENT

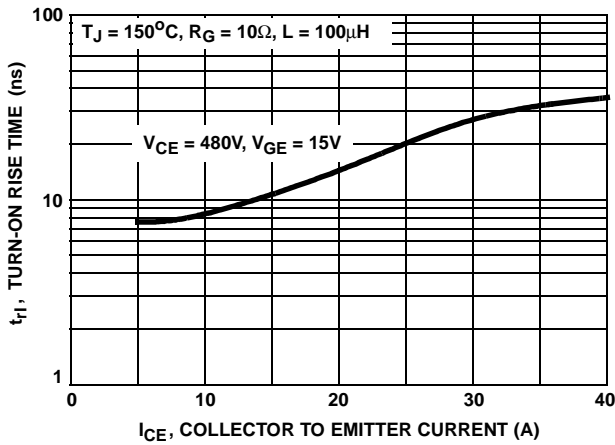

FIGURE 9. TURN-ON RISE TIME vs COLLECTOR TO EMITTER CURRENT

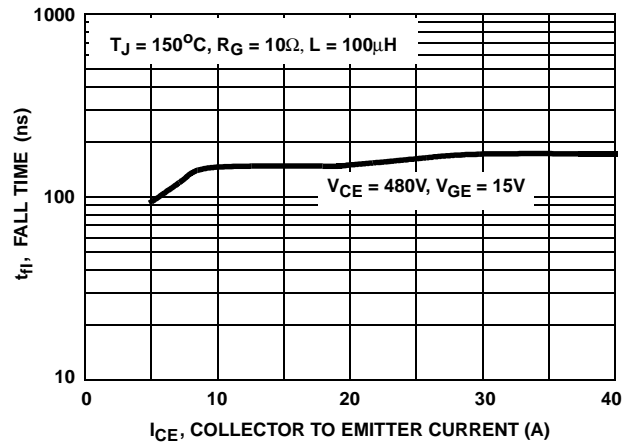

FIGURE 10. TURN-OFF FALL TIME vs COLLECTOR TO EMITTER CURRENT

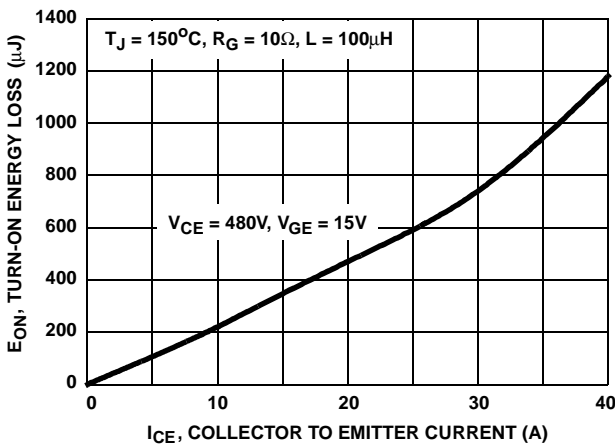

FIGURE 11. TURN-ON ENERGY LOSS vs COLLECTOR TO EMITTER CURRENT

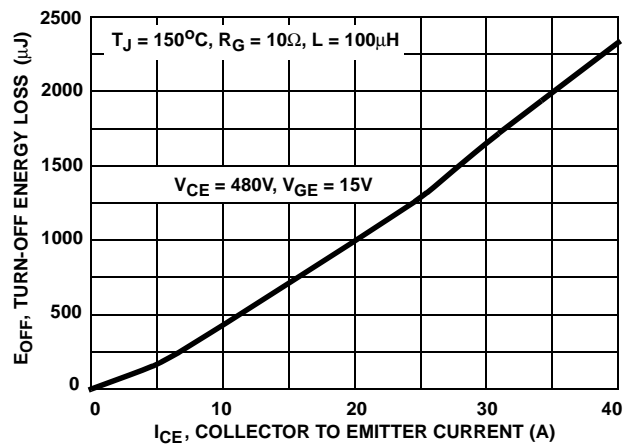

FIGURE 12. TURN-OFF ENERGY LOSS vs COLLECTOR TO EMITTER CURRENT

Typical Performance Curves (Continued)

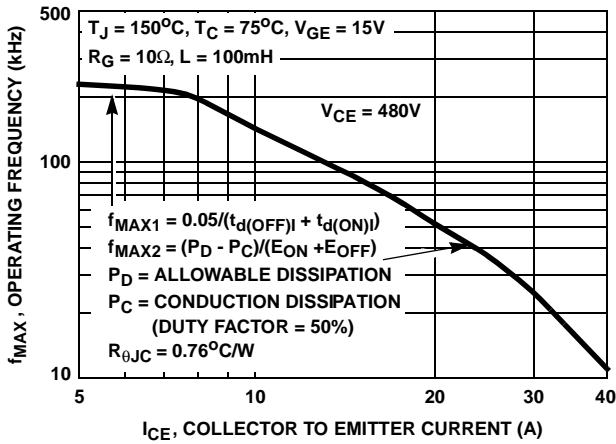

FIGURE 13. OPERATING FREQUENCY vs COLLECTOR TO EMITTER CURRENT

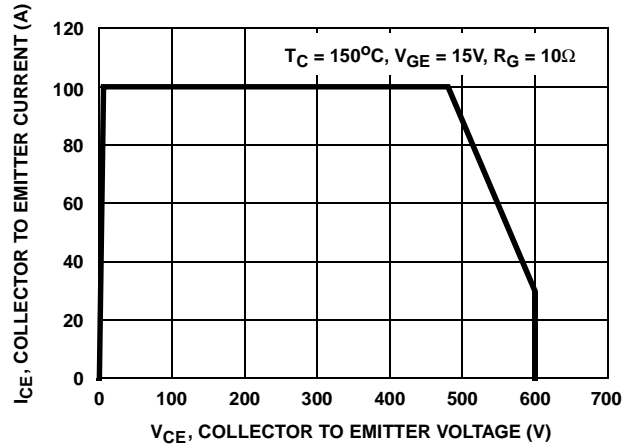

FIGURE 14. SWITCHING SAFE OPERATING AREA

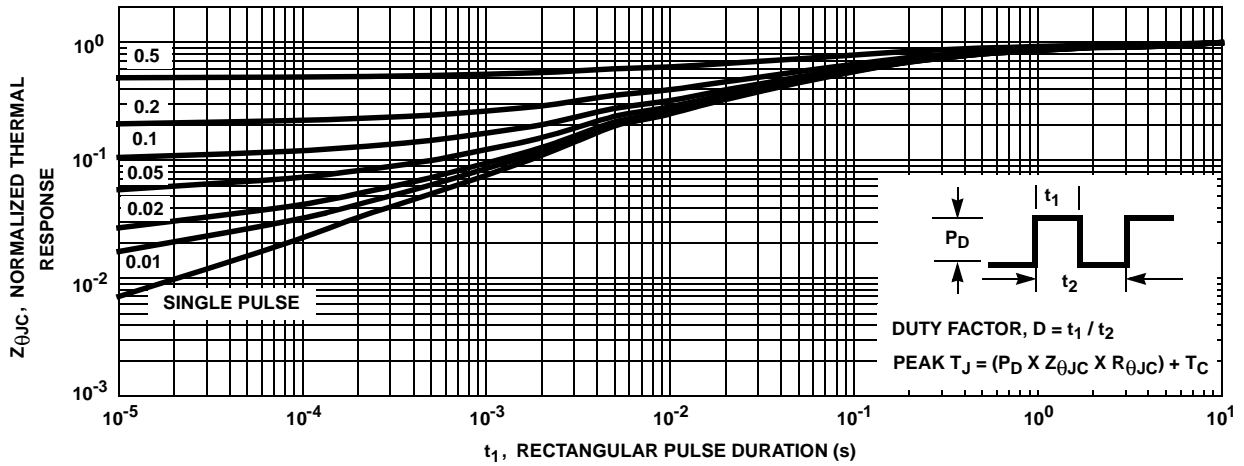

FIGURE 15. IGBT NORMALIZED TRANSIENT THERMAL RESPONSE, JUNCTION TO CASE

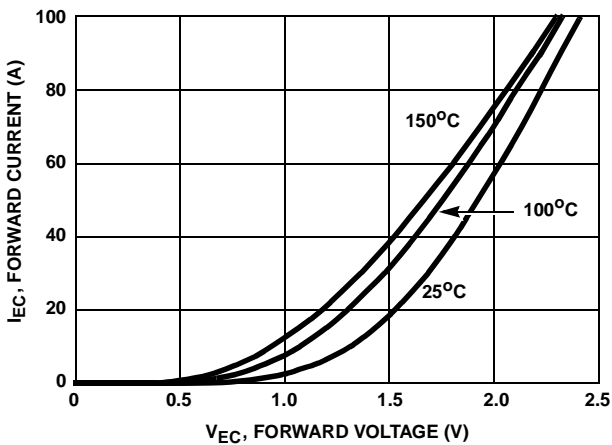

FIGURE 16. DIODE FORWARD CURRENT vs FORWARD VOLTAGE DROP

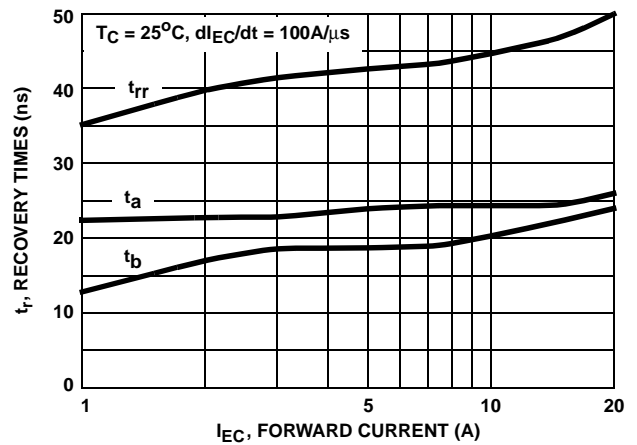

FIGURE 17. RECOVERY TIMES vs FORWARD CURRENT

Test Circuit and Waveform

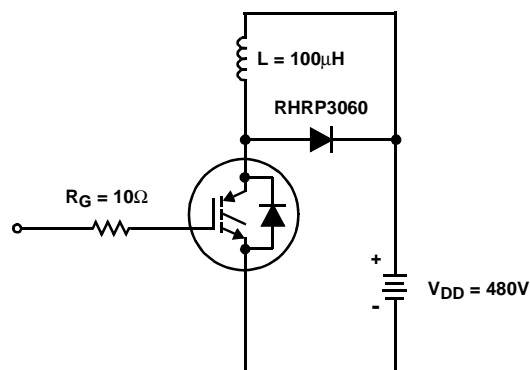

FIGURE 18. INDUCTIVE SWITCHING TEST CIRCUIT

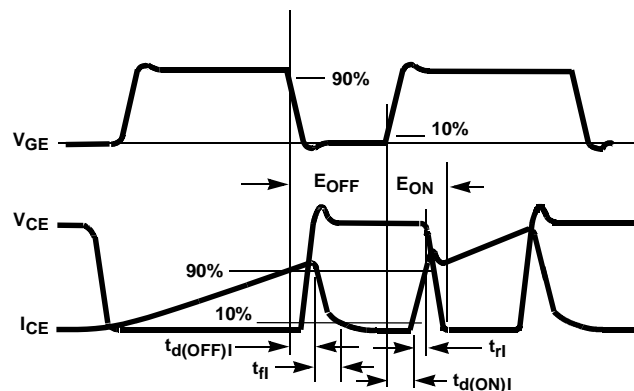

FIGURE 19. SWITCHING TEST WAVEFORMS

Handling Precautions for IGBTs

Insulated Gate Bipolar Transistors are susceptible to gate-insulation damage by the electrostatic discharge of energy through the devices. When handling these devices, care should be exercised to assure that the static charge built in the handler's body capacitance is not discharged through the device. With proper handling and discharge procedures, however, IGBTs are currently being extensively used in production by numerous equipment manufacturers in military, industrial and consumer applications, with virtually no damage problems due to electrostatic discharge. IGBTs can be handled safely if the following basic precautions are taken:

1. Prior to assembly into a circuit, all leads should be kept shorted together either by the use of metal shorting springs or by the insertion into conductive material such as "ECCOSORB™ LD26" or equivalent.
2. When devices are removed by hand from their carriers, the hand being used should be grounded by any suitable means - for example, with a metallic wristband.
3. Tips of soldering irons should be grounded.
4. Devices should never be inserted into or removed from circuits with power on.
5. **Gate Voltage Rating** - Never exceed the gate-voltage rating of V_{GEM} . Exceeding the rated V_{GE} can result in permanent damage to the oxide layer in the gate region.
6. **Gate Termination** - The gates of these devices are essentially capacitors. Circuits that leave the gate open-circuited or floating should be avoided. These conditions can result in turn-on of the device due to voltage buildup on the input capacitor due to leakage currents or pickup.
7. **Gate Protection** - These devices do not have an internal monolithic zener diode from gate to emitter. If gate protection is required an external zener is recommended.

Operating Frequency Information

Operating frequency information for a typical device (Figure 13) is presented as a guide for estimating device performance for a specific application. Other typical frequency vs collector current (I_{CE}) plots are possible using the information shown for a typical unit in Figures 4, 7, 8, 11 and 12. The operating frequency plot (Figure 13) of a typical device shows f_{MAX1} or f_{MAX2} whichever is smaller at each point. The information is based on measurements of a typical device and is bounded by the maximum rated junction temperature.

f_{MAX1} is defined by $f_{MAX1} = 0.05 / (t_{d(OFF)|} t_{d(ON)|})$. Deadtime (the denominator) has been arbitrarily held to 10% of the on- state time for a 50% duty factor. Other definitions are possible. $t_{d(OFF)|}$ and $t_{d(ON)|}$ are defined in Figure 19.

Device turn-off delay can establish an additional frequency limiting condition for an application other than T_{JM} . $t_{d(OFF)|}$ is important when controlling output ripple under a lightly loaded condition.

f_{MAX2} is defined by $f_{MAX2} = (P_D - P_C) / (E_{OFF} + E_{ON})$. The allowable dissipation (P_D) is defined by $P_D = (T_{JM} - T_C) / R_{\theta JC}$. The sum of device switching and conduction losses must not exceed P_D . A 50% duty factor was used (Figure 13) and the conduction losses (P_C) are approximated by $P_C = (V_{CE} \times I_{CE}) / 2$.

E_{ON} and E_{OFF} are defined in the switching waveforms shown in Figure 19. E_{ON} is the integral of the instantaneous power loss ($I_{CE} \times V_{CE}$) during turn-on and E_{OFF} is the integral of the instantaneous power loss during turn-off. All tail losses are included in the calculation for E_{OFF} ; i.e. the collector current equals zero ($I_{CE} = 0$).

TRADEMARKS

The following are registered and unregistered trademarks Fairchild Semiconductor owns or is authorized to use and is not intended to be an exhaustive list of all such trademarks.

ACE _x TM	FAST [®]	OPTOLOGIC TM	SMART START TM	VCX TM
Bottomless TM	FAST _r TM	OPTOPLANAR TM	STAR*POWER TM	
CoolFET TM	FRFET TM	PACMAN TM	Stealth TM	
CROSSVOLT TM	GlobalOptoisolator TM	POP TM	SuperSOT TM -3	
DenseTrench TM	GTO TM	Power247 TM	SuperSOT TM -6	
DOMET TM	HiSeC TM	PowerTrench [®]	SuperSOT TM -8	
EcoSPARK TM	ISOPLANAR TM	QFET TM	SyncFET TM	
E ² CMOS TM	LittleFET TM	QS TM	TinyLogic TM	
EnSigna TM	MicroFET TM	QT Optoelectronics TM	TruTranslation TM	
FACT TM	MicroPak TM	Quiet Series TM	UHC TM	
FACT Quiet Series TM	MICROWIRE TM	SILENT SWITCHER [®]	UltraFET [®]	

STAR*POWER is used under license

DISCLAIMER

FAIRCHILD SEMICONDUCTOR RESERVES THE RIGHT TO MAKE CHANGES WITHOUT FURTHER NOTICE TO ANY PRODUCTS HEREIN TO IMPROVE RELIABILITY, FUNCTION OR DESIGN. FAIRCHILD DOES NOT ASSUME ANY LIABILITY ARISING OUT OF THE APPLICATION OR USE OF ANY PRODUCT OR CIRCUIT DESCRIBED HEREIN; NEITHER DOES IT CONVEY ANY LICENSE UNDER ITS PATENT RIGHTS, NOR THE RIGHTS OF OTHERS.

LIFE SUPPORT POLICY

FAIRCHILD'S PRODUCTS ARE NOT AUTHORIZED FOR USE AS CRITICAL COMPONENTS IN LIFE SUPPORT DEVICES OR SYSTEMS WITHOUT THE EXPRESS WRITTEN APPROVAL OF FAIRCHILD SEMICONDUCTOR CORPORATION.

As used herein:

1. Life support devices or systems are devices or systems which, (a) are intended for surgical implant into the body, or (b) support or sustain life, or (c) whose failure to perform when properly used in accordance with instructions for use provided in the labeling, can be reasonably expected to result in significant injury to the user.
2. A critical component is any component of a life support device or system whose failure to perform can be reasonably expected to cause the failure of the life support device or system, or to affect its safety or effectiveness.

PRODUCT STATUS DEFINITIONS

Definition of Terms

Datasheet Identification	Product Status	Definition
Advance Information	Formative or In Design	This datasheet contains the design specifications for product development. Specifications may change in any manner without notice.
Preliminary	First Production	This datasheet contains preliminary data, and supplementary data will be published at a later date. Fairchild Semiconductor reserves the right to make changes at any time without notice in order to improve design.
No Identification Needed	Full Production	This datasheet contains final specifications. Fairchild Semiconductor reserves the right to make changes at any time without notice in order to improve design.
Obsolete	Not In Production	This datasheet contains specifications on a product that has been discontinued by Fairchild semiconductor. The datasheet is printed for reference information only.