



15 W Auxiliary Power for White Goods and Industrial Equipment with FSL538APG

EVAL BOARD USER'S MANUAL

Table 1. GENERAL SPECIFICATIONS

Devices	Applications	Input Voltage	Output Power	Topology	Board Size
FSL538APG	White Goods and Industrial Power Supplies	90–265 Vac	15 W	Isolated Flyback	88 × 38 × 22 mm 2.89 W/inch ³
Output Spec.	Turn on time	Efficiency	Operating Temperature	Cooling	Standby Power
15 V/0.15 A & 12 V/1 A	< 200 ms	Above 85% @ Full Load	0–50°C	Convection Open Frame	< 50 mW @ 230 Vac

Description

This user manual provides elementary information about a Non-isolated dual output flyback with FSL538APG, it performs high efficiency and smaller than 50 mW no-load power consumption. FSL538APG is an integrated pulse width modulation (PWM) and 800 V power switch with SENSEFET®, it can help to save external MOSFET and sense resistor, increase power density and reliability. This application is targeting auxiliary power supply for white goods and industrial equipment, such as refrigerator, E-metering or similar types of equipment.

The PWM controller includes an integrated variable frequency oscillator, Under-Voltage Lockout (UVLO), Leading Edge Blanking (LEB), optimized gate driver, internal soft-start, and built-in error amplifier for feedback connection directly and self-protection circuitry. This design focuses mainly on the FSL538APG current-mode PWM controller. Please refer to FSL538APG's materials to get more information about this device.

The FSL538APG is a current-mode PWM controller, it can have better response to handle dynamic operation. Controller combines line detection and burst-mode adjustment in one pin. It's easy to achieve these functionalities just need voltage divider and one Zener diode. Line detection includes brown-in, brown-out and line OVP, burst-mode adjustment is for fine tune audible noise and light load efficiency. Of course, it also provides frequency reduction with loading decreasing for gaining more design margin to improve light load efficiency.

Key Features

- Integrated Rugged 800 V Super Junction MOSFET with SENSEFET Technology
- Built-in HV Current Source for Start-up
- Peak-Current-Mode Control with Slope Compensation
- Line Compensation for Maximum Over-Power Limiting
- Advanced Soft-start for Low Electrical Stress
- Peak-Current-Mode Control with Built-in Slope Compensation
- Pulse-by-pulse Current Limit
- Line Brown-in, Brown-out, and Over-Voltage Protection (LOVP)
- Adjustable Burst-mode Operation
- Frequency Hopping for Better EMI
- Various Protections:
 - ◆ Auto Restart Mode: Brown-out, OLP, OVP, AOCV and TSD
 - ◆ Recovery Immediately by Triggering Level: LOVP

DETAIL DEMO-BOARD SCHEMATIC DESCRIPTION

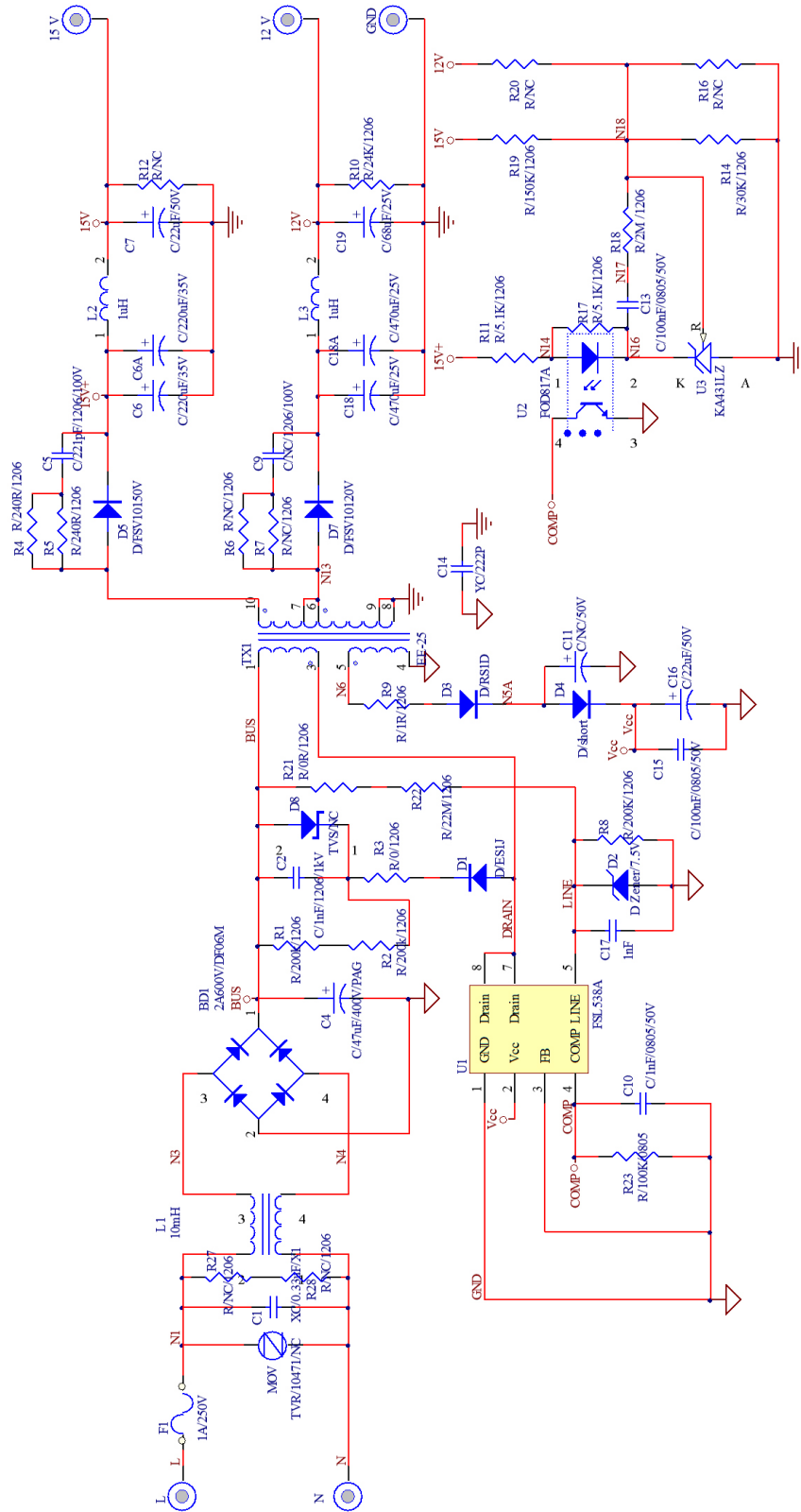

Figure 1. FSL538AFlyGEVB Demo-Board – Main Board Schematic

The input EMI filter is formed by components L1 and C1. Bleeder for X-cap, R27 and R28, are left not connected.

The primary side of flyback converter is composed of these devices; power transformer TX1, dc-link capacitor, TVS snubber, the integrated switcher U1(FSL538APG) and related components. Meanwhile, the integrated switcher has a peak current mode PWM controller and 800 V super junction MOSFET. D1, R3 and D8 form TVS snubber to protect instant voltage spike produced by leakage inductance. The FB pin of U1 needs to connect to reference ground due to isolated flyback already exists regulator as KA431LZ so that don't need to employ internal error amplifier. U2 couples the reactive current of U3 to primary side and connect to COMP pin, the coupled current and internal sourcing current is converted to control voltage of PWM for output voltage regulation, R23 and C10 can be used for adjusting response of feedback signal. LINE pin of U1 connects voltage divider from bulk capacitor to detect input voltage for some protections of brown-in, brown-out and LOVP. Besides, there is parallel-connected D2 on LINE pin to adjust burst threshold to fine tune audible noise and light load efficiency. C17 is used to avoid larger switching noise interference, which is usually recommended around 1 nF~3.3 nF. Auxiliary winding shares same ground

reference with U1. That is, reference ground is negative terminal of output of bridge rectifier BD1. Transformer winding is also used for providing VCC voltage in normal operation. R9 and D3 provide path to delivery energy when PWM is turned off. C16 can keep enough voltage if PWM is turned off for a while, and C15 is for better stability.

The secondary-side output is composed of two outputs. One is 15 V output terminal in which there are D5, C6 and C6A. The other is 12 V output terminal that composed of D7, C18 and C18A. When the MOSFET integrated in the switcher turns off, energy stored in the coupled inductor is transferred to the secondary side. At the time, there is switching noise on the output voltage, which can be, however, reduced by a LC filter on each output terminal formed by L2 and C7 (L3 and C19). U3 is a shunt regulator, and output is taken into account for generating feedback signal with network formed by R19 and R14. R18, C13, and R11 are used to adjust feedback response and bias U3. R17 provides additional biasing current for U3 to keep its required operating current. Cathode current of U3 is coupled to primary side by an opto-coupler, U2. R10 is used as dummy load for better line and load regulation at no-load condition.

EVBUM2651/D

CIRCUIT LAYOUT

The PCB consists of a double layer FR4 board with 2 oz. copper cladding.

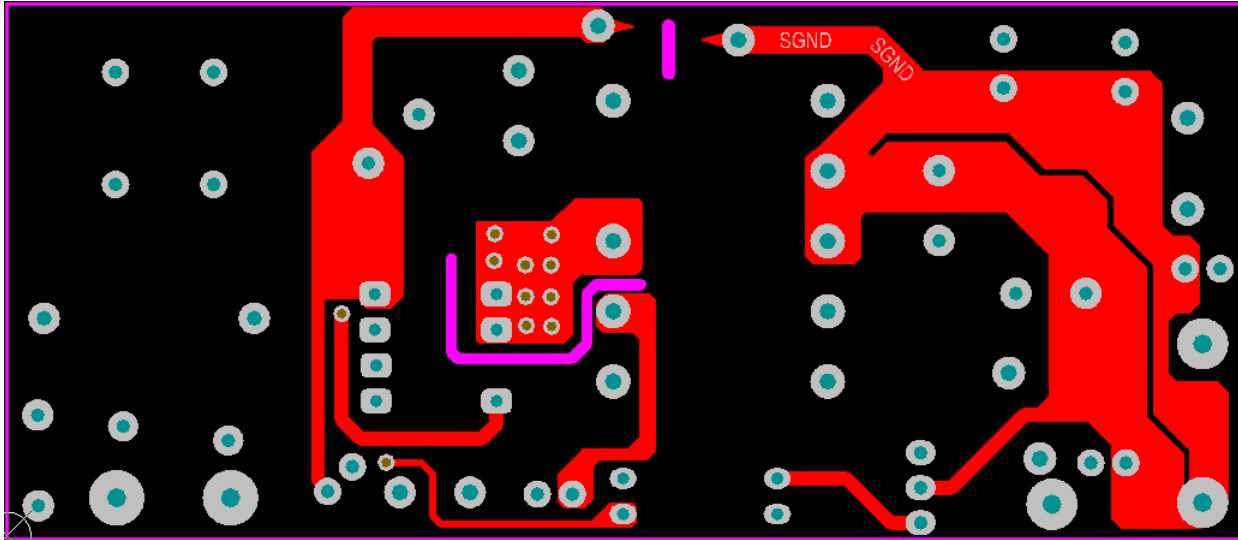

Figure 2. Main Board Top Layer

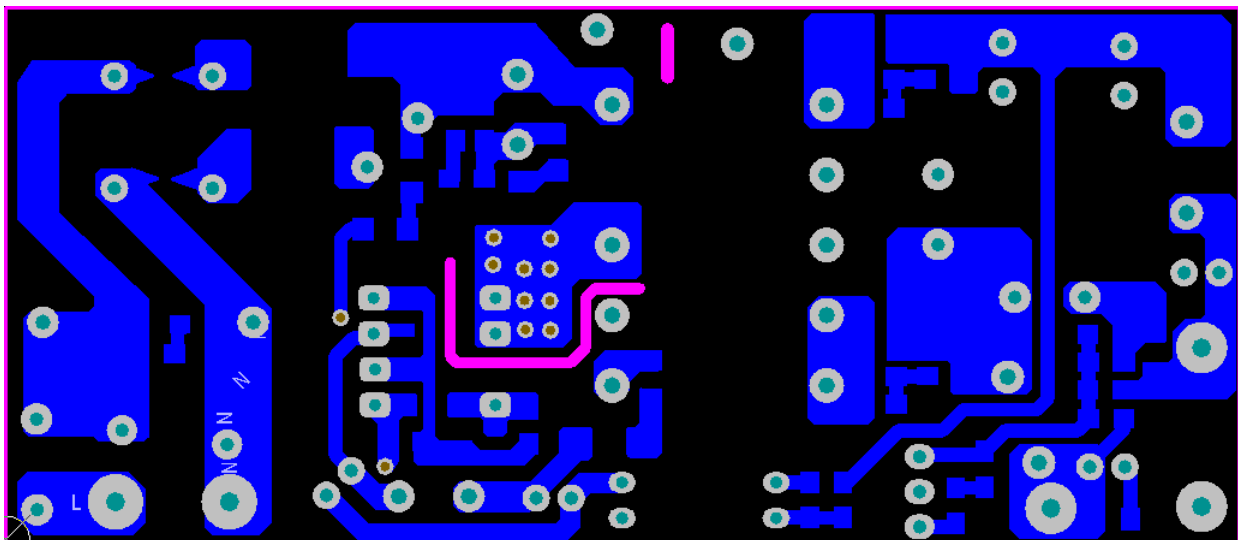

Figure 3. Main Board Bottom Layer

EVBUM2651/D

CIRCUIT LAYOUT (Continued)

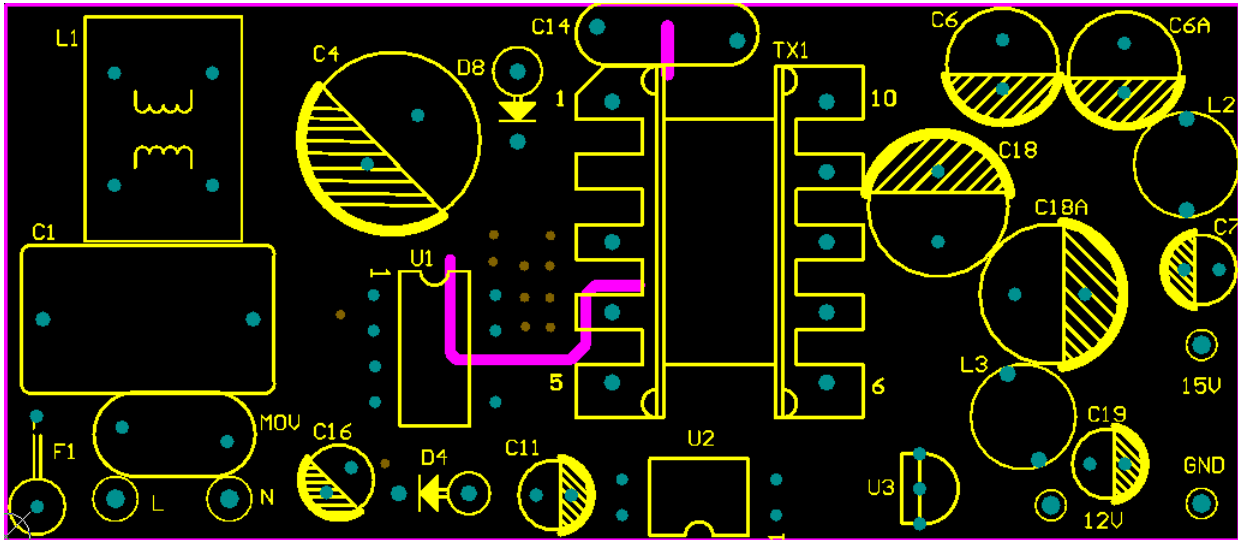

Figure 4. Main Board Top Side Components

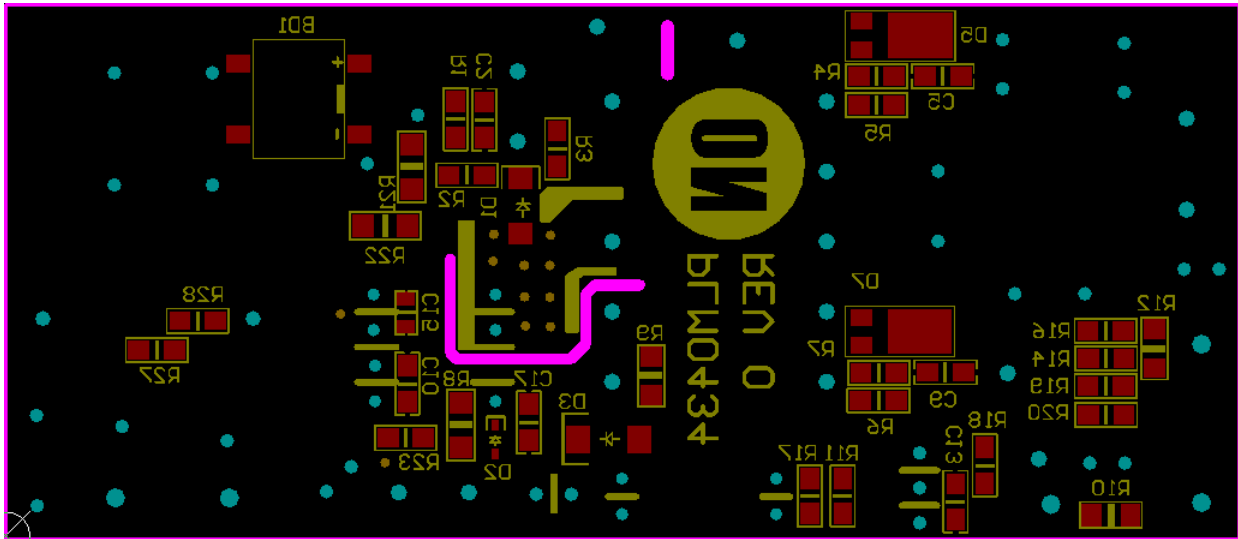

Figure 5. Main Board Bottom Side Components

EVBUM2651/D

BOARD PICTURES

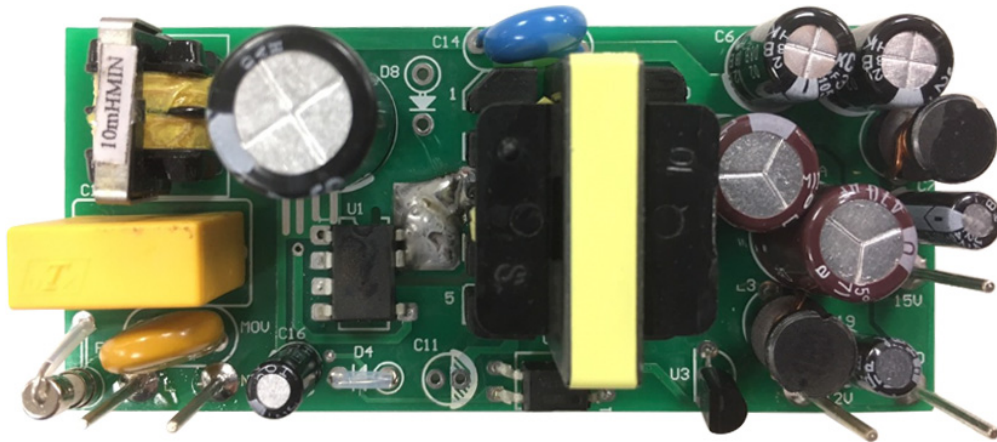

Figure 6. Main Board Photo – Top Side

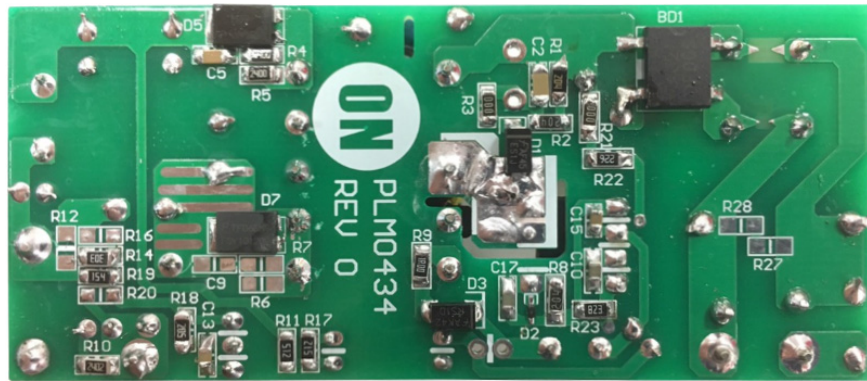

Figure 7. Main Board Photo – Bottom Side

EVBUM2651/D

TRANSFORMER DATA

Bobbin & Core : EE-25

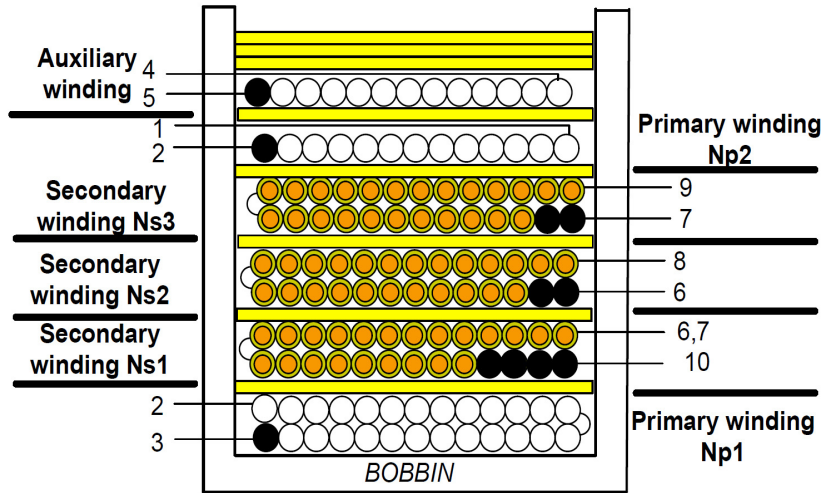
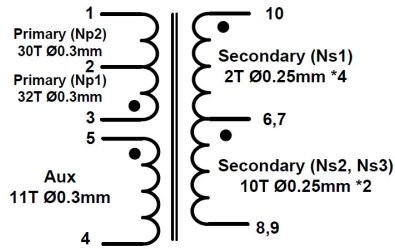

Table 2.

	Pin	Specification	Remark
Primary-Side Inductance	Drain - B+	850 μ H (Typ.)	100 kHz, 1 V

Table 3.

Layer	TERMINAL		WIRE	Turns	Isolation Layer
	Start Pin	End Pin			Turns
Primary Winding (Np1)	3	2	2UEW 0.3	32	1
Secondary (Ns1)	10	6, 7	0.25 * 4	2	1
Secondary (Ns2)	6	8	0.27 * 2	10	1
Secondary (Ns3)	7	9	0.27 * 2	10	1
Primary Winding (Np2)	2	1	2UEW 0.3	30	1
AUX Winding	5	4	2UEW 0.3 * 1	11	3

- Cut off Pin2.

TEST DATA

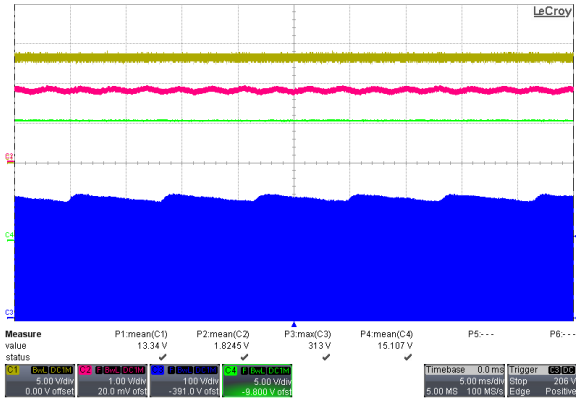

Figure 8. Operation, Full Load, 115 Vac
(Ch1: V_{CC}, Ch2: COMP, Ch3: Drain, Ch4: Vo)

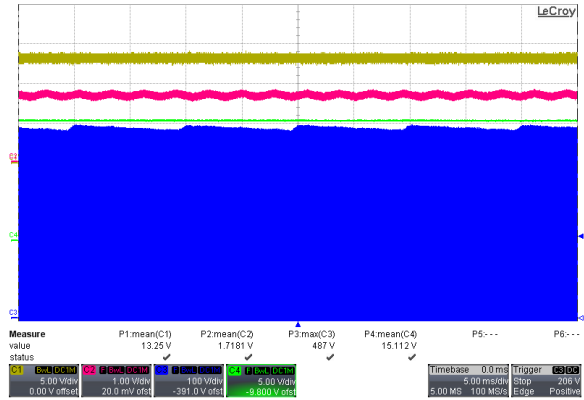

Figure 9. Operation, Full Load, 230 Vac
(Ch1: V_{CC}, Ch2: COMP, Ch3: Drain, Ch4: Vo)

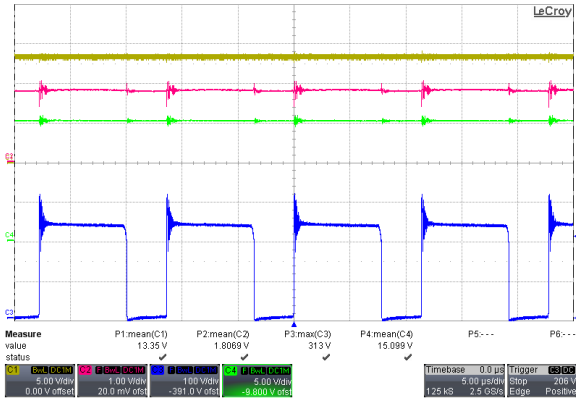

Figure 10. Zoom in Operation, Full Load, 115 Vac
(Ch1: V_{CC}, Ch2: COMP, Ch3: Drain, Ch4: Vo)

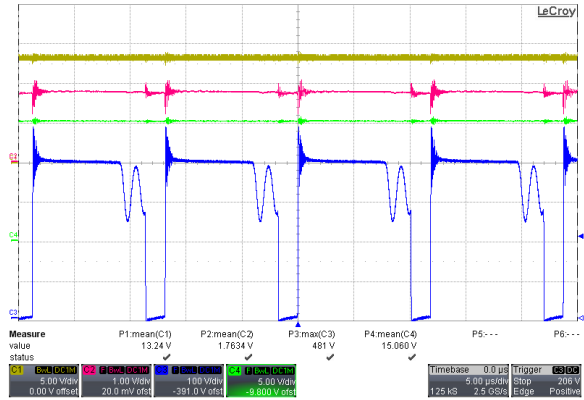

Figure 11. Zoom in Operation, Full Load, 230 Vac
(Ch1: V_{CC}, Ch2: COMP, Ch3: Drain, Ch4: Vo)

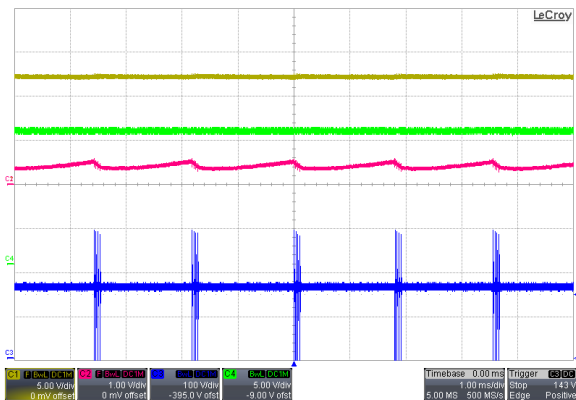

Figure 12. Operation, No Load, 115 Vac
(Ch1: V_{CC}, Ch2: COMP, Ch3: Drain, Ch4: Vo)

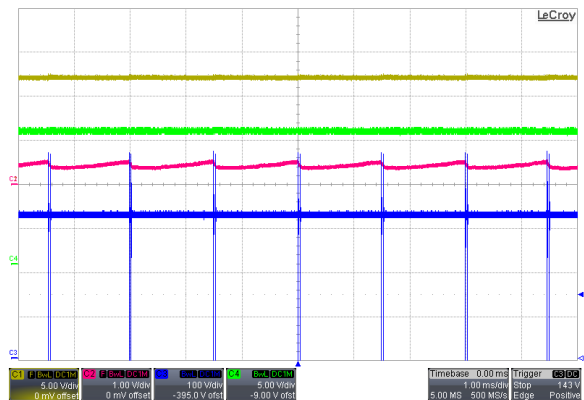

Figure 13. Operation, No Load, 230 Vac
(Ch1: V_{CC}, Ch2: COMP, Ch3: Drain, Ch4: Vo)

TEST DATA (Continued)

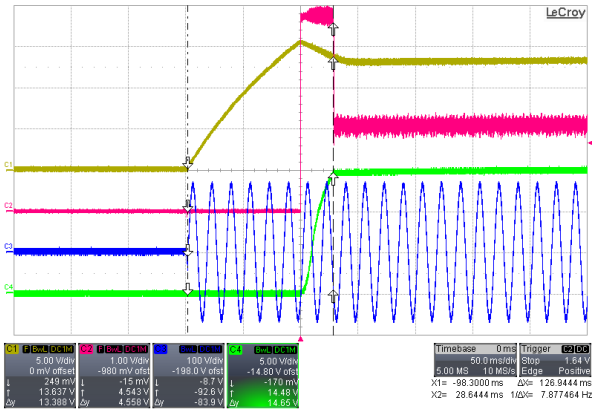

Figure 14. Ton On time, 115 Vac
(Ch1: V_{CC}, Ch2: COMP, Ch3: Vac, Ch4: Vo)

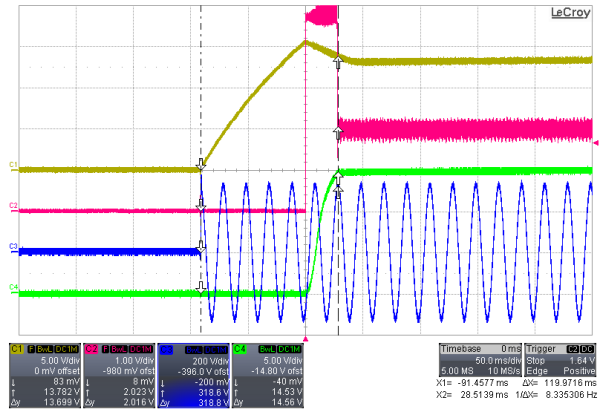

Figure 15. Ton on time, 230 Vac
(Ch1: V_{CC}, Ch2: COMP, Ch3: Vac, Ch4: Vo)

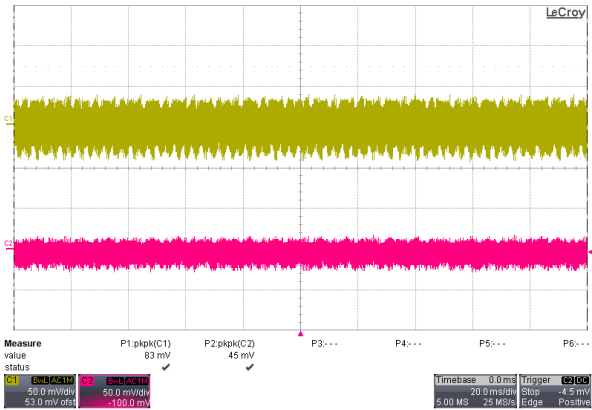

Figure 16. Output Ripple, Full Load, 115 Vac
(Ch1: V_{O-12V} (AC), Ch2: V_{O-15V} (AC))

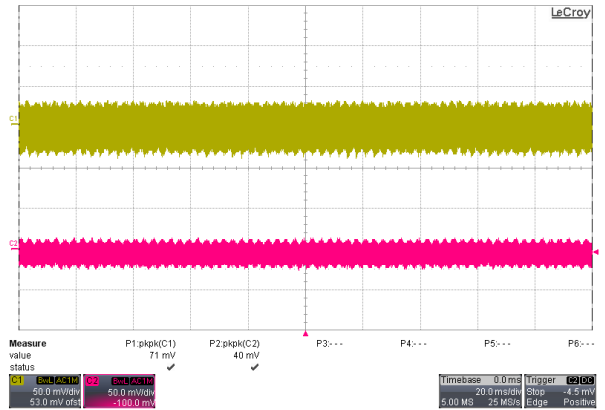

Figure 17. Output Ripple, Full Load, 230 Vac
(Ch1: V_{O-12V} (AC), Ch2: V_{O-15V} (AC))

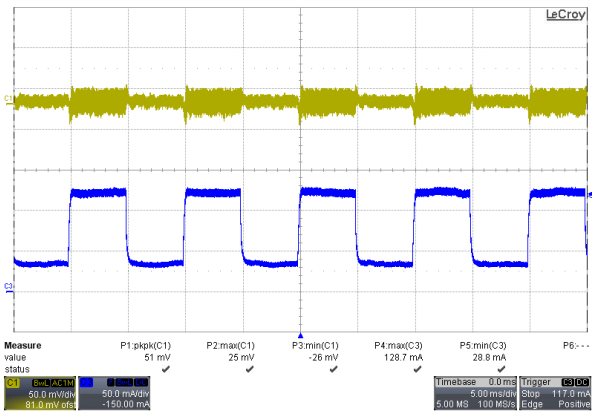

Figure 18. Dynamic operation (20%~80% of the Full Load for 15 V Output, 5 ms Duty Cycle, 2.5 A/μs Rise/Fall Time), 115 Vac
(Ch1: Vo(AC), Ch3: Io)

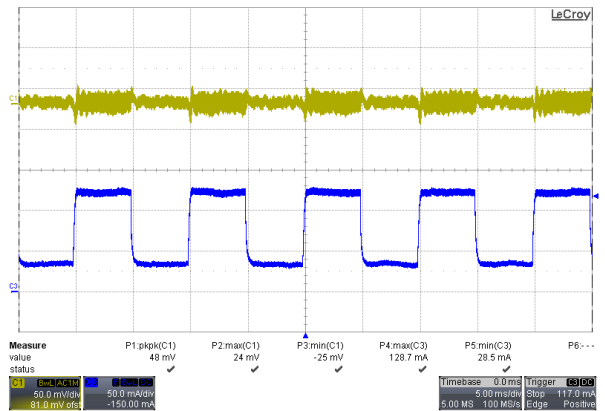

Figure 19. Dynamic Operation (20%~80% of the Full Load for 15 V Output, 5 ms Duty Cycle, 2.5 A/μs Rise/Fall Time), 230 Vac
(Ch1: Vo(AC), Ch3: Io)

TEST DATA (Continued)

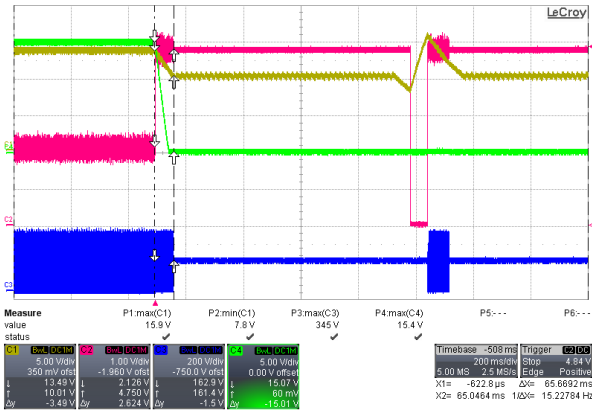

Figure 20. Output Short Triggers OLP, Full Load, 115 Vac (Ch1: V_{CC}, Ch2: COMP, Ch3: Drain, Ch4: Vo)

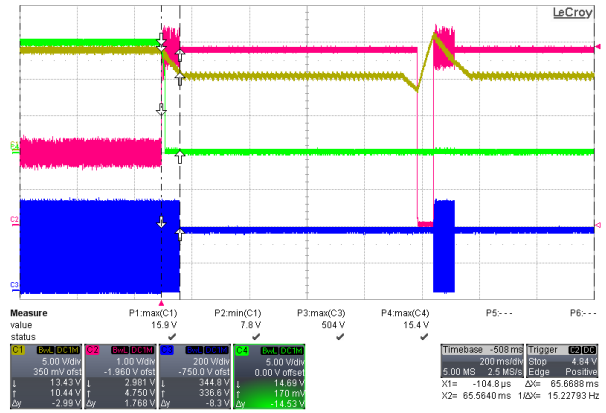

Figure 21. Output Short Triggers OLP, Full Load, 230 Vac (Ch1: V_{CC}, Ch2: COMP, Ch3: Drain, Ch4: Vo)

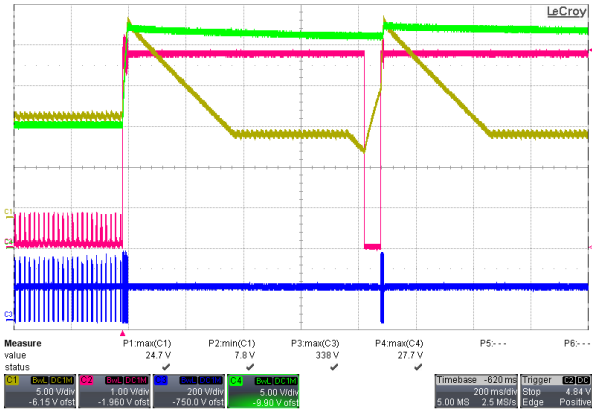

Figure 22. Short R14 to Trigger VCC OVP, No Load, 115 Vac (Ch1: V_{CC}, Ch2: COMP, Ch3: Drain, Ch4: Vo)

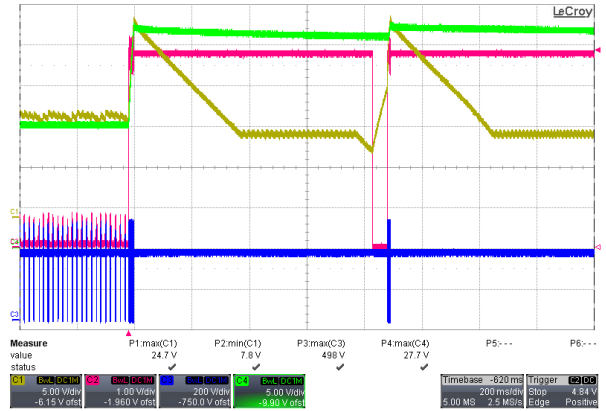

Figure 23. Short R14 to Trigger VCC OVP, No Load, 230 Vac (Ch1: V_{CC}, Ch2: COMP, Ch3: Drain, Ch4: Vo)

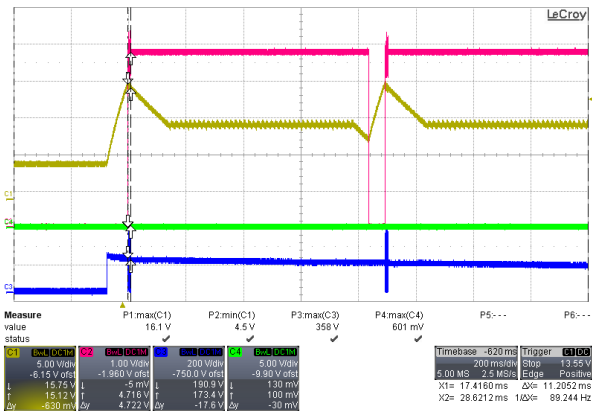

Figure 24. Short Output Schottky Diode to Trigger AOCIP, Full Load, 115 Vac (Ch1: V_{CC}, Ch2: COMP, Ch3: Drain, Ch4: Vo)

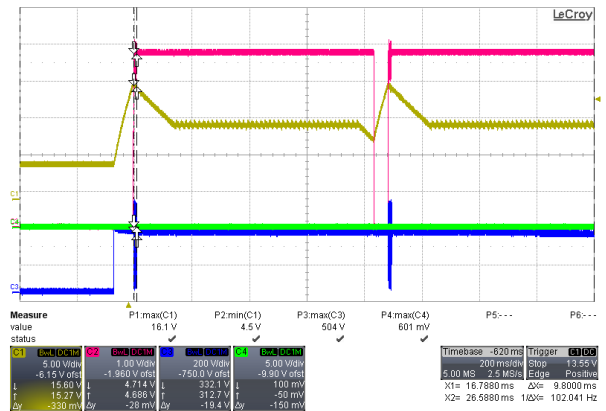

Figure 25. Short Output Schottky Diode to Trigger AOCIP, Full Load, 230 Vac (Ch1: V_{CC}, Ch2: COMP, Ch3: Drain, Ch4: Vo)

TEST DATA (Continued)

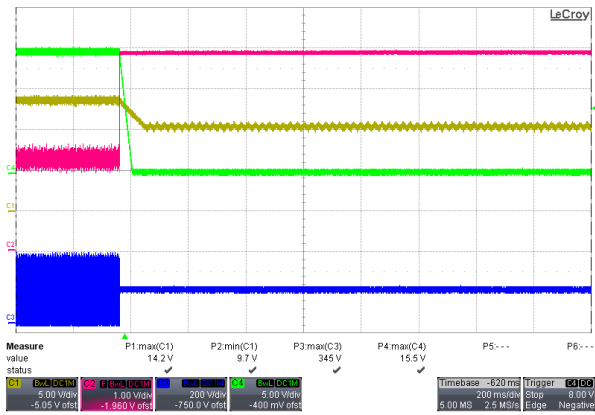

Figure 26. Heating on IC's Case to Trigger TSD, Full Load, 115 Vac (Ch1: V_{CC}, Ch2: COMP, Ch3: Drain, Ch4: Vo)

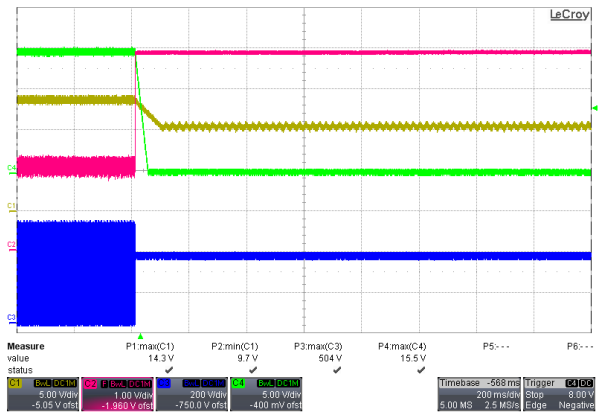

Figure 27. Heating on IC's Case to Trigger TSD, Full Load, 230 Vac (Ch1: V_{CC}, Ch2: COMP, Ch3: Drain, Ch4: Vo)

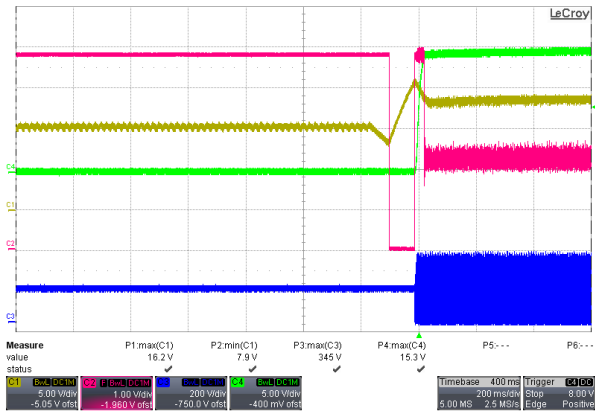

Figure 28. Remove Heating from IC's Case to Recover TSD Protection, Full Load, 115 Vac (Ch1: V_{CC}, Ch2: COMP, Ch3: Drain, Ch4: Vo)

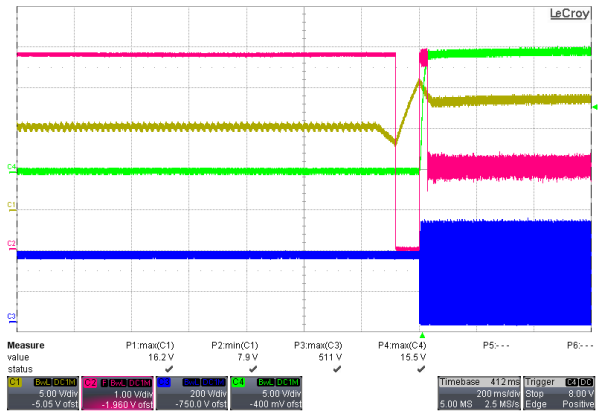

Figure 29. Remove Heating from IC's Case to Recover TSD Protection, Full Load, 230 Vac (Ch1: V_{CC}, Ch2: COMP, Ch3: Drain, Ch4: Vo)

EVBUM2651/D

Table 4. BROWN IN/OUT

Behavior	Vin (Vrms)
Brown In	78
Brown Out	65

NOTE: Test condition is full load.
Gradually increase/decrease input AC by 1 V/step.

Table 5. NO-LOAD INPUT POWER CONSUMPTION

Input Voltage [Vac]	Power Consumption [mW]
115 Vac	33.8
230 Vac	40.1

NOTE: Test condition: Outputs are connected to electronic load, but loading is not applied. Input power is integrated over three minutes.

Table 6. EFFICIENCY

Input Voltage [Vac]	25% Load	50% Load	75% Load	100% Load	Avg.
115 Vac	88.29%	88.69%	88.72%	88.23%	88.48%
230 Vac	85.29%	86.85%	88.40%	88.82%	87.34%

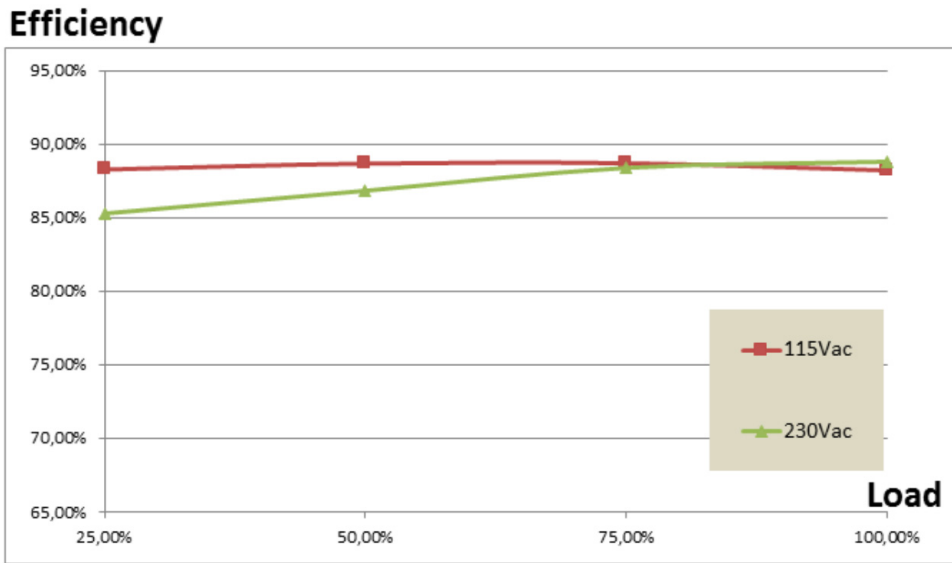

Figure 30. Board Efficiency

Table 7. LINE/LOAD REGULATION

Input Voltage [Vac]	85 Vac		115 Vac		230 Vac		265 Vac		Line Regulation (±)	
	V _{O1} (V)	V _{O2} (V)	V _{O1} (V)	V _{O2} (V)	V _{O1} (V)	V _{O2} (V)	V _{O1} (V)	V _{O2} (V)	V _{O1} (V)	V _{O2} (V)
0 W	12.501	14.916	12.499	14.916	12.512	14.914	12.515	14.915	0.001	0.007%
0.1 W	12.3525	14.915	12.346	14.915	12.346	14.912	12.339	14.914	0.001	0.010%
0.25 W	12.3235	14.913	12.307	14.914	12.313	14.911	12.297	14.912	0.001	0.010%
0.5 W	12.307	14.912	12.285	14.913	12.302	14.906	12.286	14.908	0.001	0.023%
25%	12.213	14.908	12.193	14.908	12.168	14.894	12.140	14.896	0.003	0.047%
50%	12.163	14.905	12.146	14.905	12.132	14.888	12.106	14.888	0.002	0.057%
75%	12.106	14.905	12.105	14.903	12.100	14.888	12.073	14.885	0.001	0.067%
100%	12.072	14.905	12.070	14.902	12.065	14.887	12.051	14.882	0.001	0.077%
Load Regulation (±)	1.746%	0.035%	1.744%	0.047%	1.821%	0.091%	1.887%	0.109%		

NOTE: Equation of line/load regulation is $\pm(\max - \min) / (\max + \min)$.
Measured within load range shown in specification.

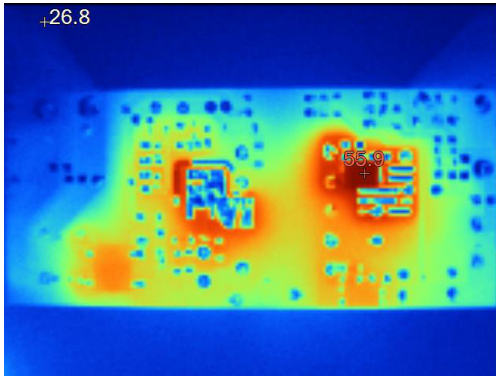

Figure 31. Temperature Checking on Bottom Side, Full Load, 115 Vac

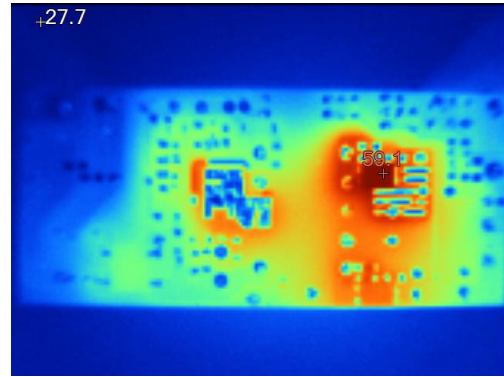

Figure 32. Temperature Checking on Bottom Side, Full Load, 230 Vac

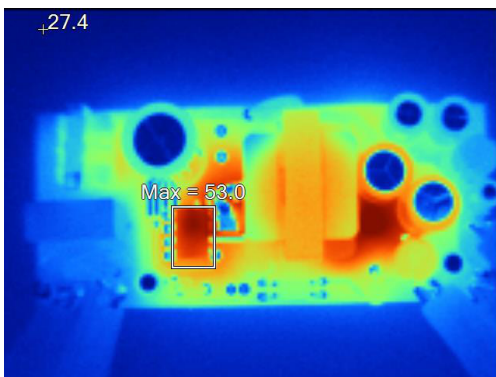

Figure 33. Temperature Checking on Top Side, Full Load, 115 Vac

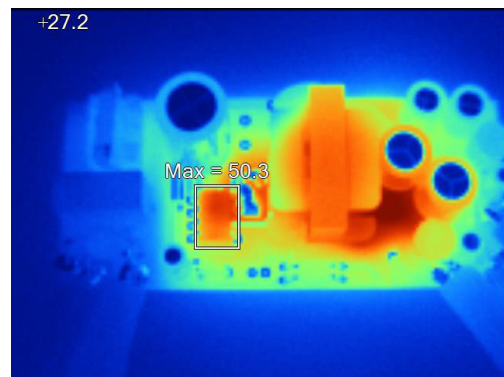

Figure 34. Temperature Checking on Top Side, Full Load, 230 Vac

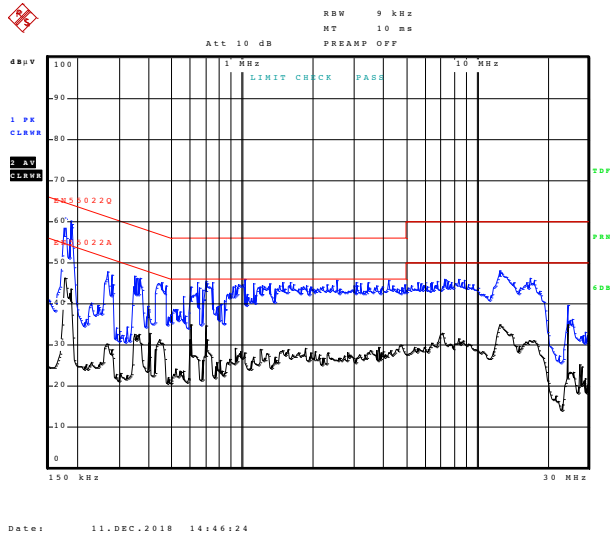

Figure 35. Conducted EMI, 115 Vac, LINE

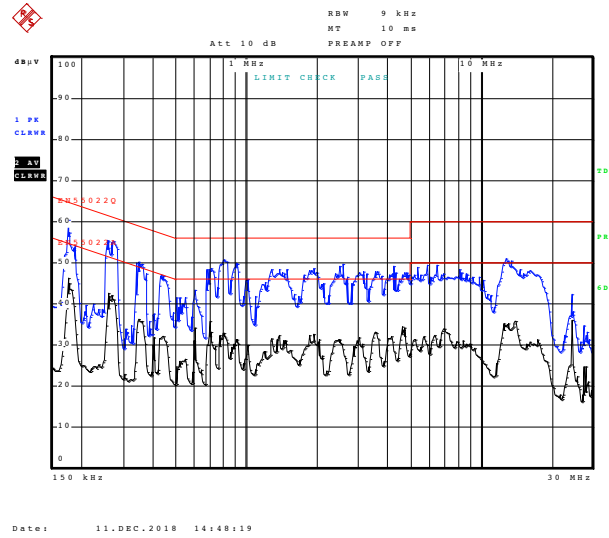

Figure 36. Conducted EMI, 230 Vac, LINE

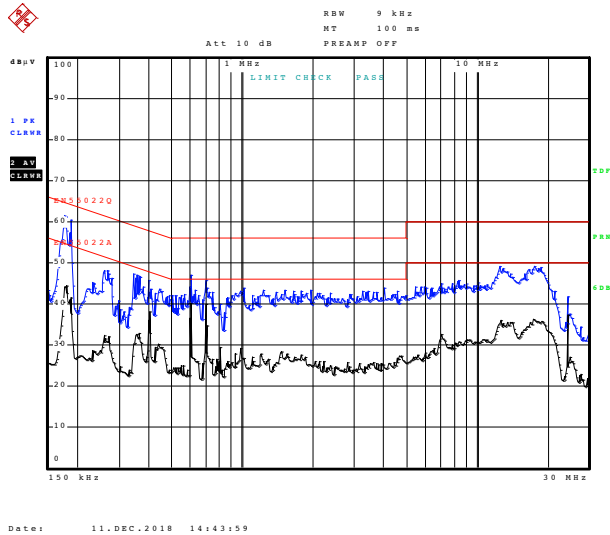

Figure 37. Conducted EMI, 115 Vac, Neutral

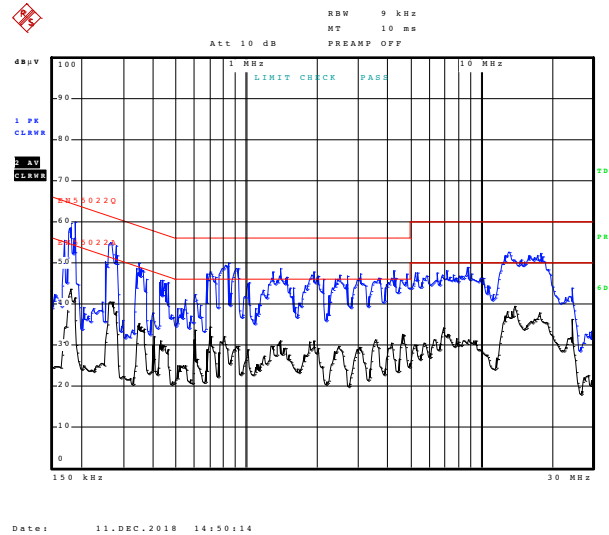

Figure 38. Conducted EMI, 230 Vac, Neutral

EVBUM2651/D

BILL OF MATERIALS

Table 8. BILL OF MATERIALS

Parts	Qty	Description	Value	Tolerance	Footprint	Manufacturer	Manufacturer Part Number	Substitution Allowed	Pb-Free
C1	1	X2 Capacitor	0.33 μ F/275 V	\pm 10%	17 \times 7.5 \times 15.5 mm Pitch = 15 mm	CARLI	PX334K3ID1	Yes	Yes
C2	1	MLCC X7R Capacitor	102 pF/1 kV	\pm 10%	1206	KEMET	C1206C102KDRACTU	Yes	Yes
C4	1	Electrolytic Capacitor	47 μ F/400 V	\pm 20%	12.5 \times 20 mm	Rubycon	QXW	Yes	Yes
C5	1	MLCC X7R Capacitor	221 pF/100 V	\pm 10%	1206	Taiwan-Resister	CP221K100XRC	Yes	Yes
C6, C6A	2	Electrolytic Capacitor	220 μ F/35 V	\pm 20%	8 \times 11 mm	JACKCON	LHK	Yes	Yes
C7, C16	2	Electrolytic Capacitor	22 μ F/50 V	\pm 20%	5 \times 11 mm	JACKCON	LHK	Yes	Yes
C10, C17	2	MLCC X7R Capacitor	102 pF/50 V	\pm 10%	0805	Taiwan-Resister	CP102K050XRB	Yes	Yes
C13, C15	2	MLCC X7R Capacitor	104 pF/50 V	\pm 10%	0805	Taiwan-Resister	CP104K050XRB	Yes	Yes
C14	1	Y1 Capacitor	222 pF/250 V	\pm 20%		UNIVERSE	CD12-E2GA222MYASA	Yes	Yes
C18, C18A	2	Electrolytic Capacitor	470 μ F/25 V	\pm 10%	10 \times 20 mm	Chemi-con	KME	Yes	Yes
C19	1	Electrolytic Capacitor	68 μ F/25 V	\pm 20%	5 \times 11 mm	Rubycon	ZLH	Yes	Yes
R3, R21	2	Resistor SMD	0 Ω	\pm 5%	1206	Taiwan-Resister	RP12000JR	Yes	Yes
R4, R5	2	Resistor SMD	240 Ω	\pm 5%	1206	Taiwan-Resister	RP12240RJR	Yes	Yes
R1, R2, R8	3	Resistor SMD	200 k Ω	\pm 5%	1206	Taiwan-Resister	RP12200KJR	Yes	Yes
R9	1	Resistor SMD	1 Ω	\pm 5%	1206	Taiwan-Resister	RP1201ROJR	Yes	Yes
R10	1	Resistor SMD	24 k Ω	\pm 5%	0805	Taiwan-Resister	RP0824KOJR	Yes	Yes
R11, R17	2	Resistor SMD	5.1 k Ω	\pm 5%	0805	Taiwan-Resister	RP0805K1JR	Yes	Yes
R14	1	Resistor SMD	30 k Ω	\pm 5%	1206	Taiwan-Resister	RP1230KOJR	Yes	Yes
R18	1	Resistor SMD	2 M Ω	\pm 5%	1206	Taiwan-Resister	RP1202MJR	Yes	Yes
R19	1	Resistor SMD	150 k Ω	\pm 5%	1206	Taiwan-Resister	RP12150KJR	Yes	Yes
R22	1	Resistor SMD	22 M Ω	\pm 5%	1206	Taiwan-Resister	RP1222MOJR	Yes	Yes
R23	1	Resistor SMD	100 k Ω	\pm 5%	1206	Taiwan-Resister	RP12100KJR	Yes	Yes
D1	1	Fast Rectifier	600 V, 1 A		DO-214AC	ON Semiconductor	ES1J	Yes	Yes
D2	1	Zener Diode	7.5 V, 0.2 W		SOD-523F	ON Semiconductor	MMSZ7V5	Yes	Yes
D3	1	Fast Rectifier	200 V, 1 A		DO-214AC	ON Semiconductor	RS1D	Yes	Yes
D4	1	Jumper Wire	Short					Yes	Yes
D5	1	Schottky Rectifier	150 V, 10 A		TO-277	ON Semiconductor	FSV10150V	Yes	Yes
D7	1	Schottky Rectifier	120 V, 10 A		TO-277	ON Semiconductor	FSV10120V	Yes	Yes
15 V, 12 V, GND, L, N	5	TEST PIN	Pin W2.2 \times 18.2 mm OEM-10		2.2 \times 18.2 mm m	KANG YANG	SG004-05 Pin	Yes	Yes
F1	1	Fuse	FUSE CERAMIC 1 A/ 250 V SLOW		3.6 \times 10 mm		37SG	Yes	Yes
MOV	1	MOV	470 V	\pm 10%		THINKING	MOV-471KD10SBNL	Yes	Yes
BD1	1	Bridge Rectifier	600 V, 2 A		SDIP-4	ON Semiconductor	DF06S	Yes	Yes
L1	1	Common-mode Choke	10 mH		UU9.8	SEN HUEI	TRN0356	Yes	Yes
L2, L3	2	Inductor, Ferrite Core	1 μ H		DR 6 \times 8	WURTH	744772010	Yes	Yes

EVBUM2651/D

Table 8. BILL OF MATERIALS (continued)

Parts	Qty	Description	Value	Tolerance	Footprint	Manufacturer	Manufacturer Part Number	Substitution Allowed	Pb-Free
TX1	1	Transformer	850 μ H	\pm 10%	EE-25-10 pin			No	Yes
U1	1	PWM with Power SENSEFET			7DIP	ON Semiconductor	FSL538APG	No	Yes
U2	1	Opto Coupler	CTR = 80-160%		DIP 4-pin	ON Semiconductor	FOD817A	Yes	Yes
U3	1	Shunt Regulator	Adjustable, 2.5 V	1%	TO-92	ON Semiconductor	NCP431AVLPRAG	Yes	Yes
	1	PCB					PLM0434V0	No	Yes
D4, F1	2	Teflon Tube	17L x 305 m					Yes	Yes

SENSEFET is a registered trademark of Semiconductor Components Industries, LLC (SCILLC) or its subsidiaries in the United States and/or other countries.

ON Semiconductor and the ON Semiconductor logo are trademarks of Semiconductor Components Industries, LLC dba ON Semiconductor or its subsidiaries in the United States and/or other countries. ON Semiconductor owns the rights to a number of patents, trademarks, copyrights, trade secrets, and other intellectual property. A listing of ON Semiconductor's product/patent coverage may be accessed at www.onsemi.com/site/pdf/Patent-Marking.pdf. ON Semiconductor is an Equal Opportunity/Affirmative Action Employer. This literature is subject to all applicable copyright laws and is not for resale in any manner.

The evaluation board/kit (research and development board/kit) (hereinafter the "board") is not a finished product and is as such not available for sale to consumers. The board is only intended for research, development, demonstration and evaluation purposes and should as such only be used in laboratory/development areas by persons with an engineering/technical training and familiar with the risks associated with handling electrical/mechanical components, systems and subsystems. This person assumes full responsibility/liability for proper and safe handling. Any other use, resale or redistribution for any other purpose is strictly prohibited.

The board is delivered "AS IS" and without warranty of any kind including, but not limited to, that the board is production-worthy, that the functions contained in the board will meet your requirements, or that the operation of the board will be uninterrupted or error free. ON Semiconductor expressly disclaims all warranties, express, implied or otherwise, including without limitation, warranties of fitness for a particular purpose and non-infringement of intellectual property rights.

ON Semiconductor reserves the right to make changes without further notice to any board.

You are responsible for determining whether the board will be suitable for your intended use or application or will achieve your intended results. Prior to using or distributing any systems that have been evaluated, designed or tested using the board, you agree to test and validate your design to confirm the functionality for your application. Any technical, applications or design information or advice, quality characterization, reliability data or other services provided by ON Semiconductor shall not constitute any representation or warranty by ON Semiconductor, and no additional obligations or liabilities shall arise from ON Semiconductor having provided such information or services.

The boards are not designed, intended, or authorized for use in life support systems, or any FDA Class 3 medical devices or medical devices with a similar or equivalent classification in a foreign jurisdiction, or any devices intended for implantation in the human body. Should you purchase or use the board for any such unintended or unauthorized application, you shall indemnify and hold ON Semiconductor and its officers, employees, subsidiaries, affiliates, and distributors harmless against all claims, costs, damages, and expenses, and reasonable attorney fees arising out of, directly or indirectly, any claim of personal injury or death associated with such unintended or unauthorized use, even if such claim alleges that ON Semiconductor was negligent regarding the design or manufacture of the board.

This evaluation board/kit does not fall within the scope of the European Union directives regarding electromagnetic compatibility, restricted substances (RoHS), recycling (WEEE), FCC, CE or UL, and may not meet the technical requirements of these or other related directives.

FCC WARNING – This evaluation board/kit is intended for use for engineering development, demonstration, or evaluation purposes only and is not considered by ON Semiconductor to be a finished end product fit for general consumer use. It may generate, use, or radiate radio frequency energy and has not been tested for compliance with the limits of computing devices pursuant to part 15 of FCC rules, which are designed to provide reasonable protection against radio frequency interference. Operation of this equipment may cause interference with radio communications, in which case the user shall be responsible, at its expense, to take whatever measures may be required to correct this interference.

ON Semiconductor does not convey any license under its patent rights nor the rights of others.

LIMITATIONS OF LIABILITY: ON Semiconductor shall not be liable for any special, consequential, incidental, indirect or punitive damages, including, but not limited to the costs of requalification, delay, loss of profits or goodwill, arising out of or in connection with the board, even if ON Semiconductor is advised of the possibility of such damages. In no event shall ON Semiconductor's aggregate liability from any obligation arising out of or in connection with the board, under any theory of liability, exceed the purchase price paid for the board, if any.

For more information and documentation, please visit www.onsemi.com.

PUBLICATION ORDERING INFORMATION

LITERATURE FULFILLMENT:

Email Requests to: orderlit@onsemi.com

ON Semiconductor Website: www.onsemi.com

TECHNICAL SUPPORT

North American Technical Support:

Voice Mail: 1 800-282-9855 Toll Free USA/Canada

Phone: 011 421 33 790 2910

Europe, Middle East and Africa Technical Support:

Phone: 00421 33 790 2910

For additional information, please contact your local Sales Representative