

# High Precision Positioning Inductive Proximity Sensor

# E2C-EDA

CSM\_E2C-EDA\_DS\_E\_8\_4

## Proximity Sensor with Separate Amplifier Enables Easily Making High-precision Sensitivity Settings.



- Wide variety of Sensor Heads to select according to the application. Flexible cables are used between Preamplifiers and Amplifier Units of the Sensor Heads.
- High resistance to changes in ambient temperature. Temperature characteristics of 0.08%/°C (for 5.4-dia. models).
- Make simple and reliable detection settings with micron-level precision using the teaching function.
- Check the sensing excess gain level on the digital display.
- Support for high-precision positioning and screening with fine positioning to maximize variations.
- The E2C-EDA0 supports an EtherCAT Sensor Communications Unit or CompoNet Sensor Communications Unit.



For the most recent information on models that have been certified for safety standards, refer to your OMRON website.

Be sure to read *Safety Precautions* on page 10.

## Ordering Information

**Sensors** [Refer to *Dimensions* on page 12.]

### Sensor Heads

Type	Appearance	Sensing distance	Repeat accuracy	Cable specification	Model	
Shielded	Cylindrical 	3 dia. × 18 mm	0.6 mm	1 μm	Free cutting *2	E2C-EDR6-F
		5.4 dia. × 18 mm	1 mm	1 μm	Standard *2	E2C-ED01
					Free cutting *2	E2C-ED01-F
					With Protective Spiral Tube *1 *2	E2C-ED01-S
		8 dia. × 22 mm	2 mm	2 μm	Standard *2	E2C-ED02
					Free cutting *2	E2C-ED02-F
	With Protective Spiral Tube *1 *2	E2C-ED02-S				
		Screw 	M10 × 22 mm	2 μm	Standard *2	E2C-EM02
	Free cutting *2				E2C-EM02-F	
	With Protective Spiral Tube *1 *2				E2C-EM02-S	
Flat 	30 × 14 × 4.8 mm	5 mm	2 μm	Standard *2	E2C-EV05	
				Free cutting *2	E2C-EV05-F	
				With Protective Spiral Tube *1 *2	E2C-EV05-S	
Unshielded 	M18 × 46.3 mm	7 mm	5 μm	Standard *2	E2C-EM07M	
				Free cutting *2	E2C-EM07M-F	
				With Protective Spiral Tube *1 *2	E2C-EM07M-S	
Heat-resistant 	M12 × 22 mm	2 mm	2 μm	Standard *2	E2C-EM02H	

\*1 Ask your OMRON representative for information on the Protective Spiral Tube.

\*2 Overall length of free-cut cable: 3.5 m, Length from the Sensor Head to the Preamplifier: 0.5 m (Overall length of the standard cable with Protective Spiral Tube: 2.5 m, Length from the Sensor Head to the Preamplifier: 2 m)

## Amplifier Units

### Amplifier Units with Cables

Item	Appearance	Functions	Model	
			NPN output	PNP output
Advanced models		Area output, open circuit detection, differential operation	E2C-EDA11 2M	E2C-EDA41 2M
			E2C-EDA21 2M	E2C-EDA51 2M

### Amplifier Units with Wire-saving Connectors (An Amplifier Unit Connector (sold separately) is required.)

Item	Appearance	Functions	Model	
			NPN output	PNP output
Advanced models		Area output, open circuit detection, differential operation	E2C-EDA6	E2C-EDA8
			E2C-EDA7	E2C-EDA9

**Note:** These models allow you to use an E3X-DRT21-S VER.3 Sensor Communications Unit. When using the E3X-DRT21-S VER.3, use an E3X-CN02 Connector without a Cable for the Wire-saving Connector.

### Amplifier Unit with Connector for EtherCAT or CompoNet Sensor Communications Units [Refer to Dimensions page 16]

Item	Appearance	Functions	Model	Applicable Sensor Communications Unit
Advanced model		Area output, open circuit detection, differential operation	E2C-EDA0	E3X-ECT E3X-CRT

## Wire-saving Connectors (Order Separately)

**Note:** Protector seals provided. [Refer to E3X-DA-S/MDA.]

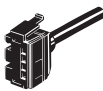
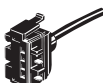
Item	Appearance	Cable length	No. of conductors	Model
Master Connector		2 m	4	E3X-CN21
Slave Connector			2	E3X-CN22

### Ordering Precaution for Amplifier Units with Wire-saving Connectors





A Connector is not provided with the Amplifier Unit.  
Refer to the following tables when ordering.

Amplifier Unit			Applicable Connector (Order Separately)	
Model	NPN output	PNP output	Master Connector	Slave Connector
Advanced models	E2C-EDA6	E2C-EDA8	E3X-CN21	E3X-CN22
	E2C-EDA7	E2C-EDA9		

When Using 5 Amplifier Units

Amplifier Units (5 Units)	+	1 Master Connector	4 Slave Connectors
---------------------------	---	--------------------	--------------------

**Mobile Console (Order Separately)** [Refer to E3X-DA-S/MDA.]

Appearance	Model	Remarks
	E3X-MC11-SV2 (model number of set)	Mobile Console with Head, Cable, and AC adapter provided as accessories
	E3X-MC11-C1-SV2	Mobile Console
	E3X-MC11-H1	Head
	E39-Z12-1	Cable (1.5 m)

**Note:** Use the E3X-MC11-SV2 Mobile Console with E2C-EDA-series Amplifier Units. If you use a Mobile Console like the E3X-MC11-S, some functions may not operate. For details, refer to *Ratings and Specifications* for E3X-DA-S/MDA.

**Accessories (Order Separately)****Mounting Bracket**

A Mounting Bracket is not provided with the Amplifier Unit. Order a Mounting Bracket separately if required.

[Refer to E39-L, F39-L, E39-S, and E39-R.]

Appearance	Model	Quantity
	E39-L143	1

**End Plate**

An End Plate is not provided with the Amplifier Unit. Order an End Plate separately if required.

[Refer to PFP-□.]

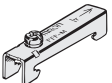
Appearance	Model	Quantity
	PFP-M	1

**Extension Cables for Sensor Head**

An Extension Cable is not provided with the Amplifier Unit. Order an Extension Cable separately if required.

[Refer to Dimensions on page 13.]

Cable length	Model	Quantity
2 m	E22-XC2R	1
7 m	E22-XC7R	

## Rating and Specifications

### Sensor Heads

Model		E2C-EDR6-F	E2C-ED01(-□)	E2C-ED02(-□)	E2C-EM02(-□)	E2C-EM07(-□)	E2C-EV05(-□)	E2C-EM02H	
Item		3 dia. × 18 mm	5.4 dia. × 18 mm	8 dia. × 22 mm	M10 × 22 mm	M18 × 46.3 mm	30 × 14 × 4.8 mm	M12 × 22 mm	
Sensing distance		0.6 mm	1 mm	2 mm		7 mm	5 mm	2 mm	
Sensing object		Magnetic metal (The sensing distance will decrease when sensing non-magnetic metal. Refer to <i>Engineering Data (Reference Value)</i> on page 6.)							
Standard sensing object		5 × 5 × 3 mm		10 × 10 × 3 mm		22 × 22 × 3 mm	15 × 15 × 3 mm	20 × 20 × 3 mm	
		Material: iron (S50C)							
Repeat accuracy *1		1 μm		2 μm		5 μm	2 μm		
Hysteresis distance		Variable							
Temperature characteristic *1	Sensor Head	0.3%/°C		0.08%/°C		0.04%/°C		0.2%/°C	
	Preamplifier and Amplifier	0.08%/°C							
Ambient temperature *2	Operating	-10°C to 60°C (with no icing or condensation)							-10°C to 200°C *3
	Storage	-10°C to 60°C (with no icing or condensation)	-20°C to 70°C (with no icing or condensation)						
Ambient humidity		Operating/storage: 35% to 85% (with no condensation)							
Insulation resistance		50 MΩ min. (at 500 VDC)							
Dielectric strength		1,000 VAC at 50/60 Hz for 1 min between current carry parts and case							
Vibration resistance		Destruction: 10 to 55 Hz, 1.5-mm double amplitude for 2 hours each in X, Y, and Z directions							
Shock resistance		Destruction: 500 m/s <sup>2</sup> for 3 times each in X, Y, and Z directions							
Degree of protection		IEC60529 IP67							IEC60529 IP60 *4
Connection method		Connector (standard cable length: 2.5 m (2 m between Head and Preamplifier) “-F” model cable length: 3.5 m (0.5 m between Head and Preamplifier)							
Weight (packed state)		Approx. 120 g (Models with protective spiral tube (“-S” models) are approx. 90 g heavier.)							
Material	Sensor Head	Case	Brass	Stainless steel	Brass		Zinc	Brass	
		Sensing surface	Heat-resistant ABS						PEEK
		Clamping nut	---			Nickel-plated brass		---	Nickel-plated brass
		Toothed washer	---			Zinc-plated iron		---	Zinc-plated iron
	Preamplifier	PES							
Accessories		Preamplifier Mounting Brackets, Instruction Manual							

\*1 The repeat accuracy and temperature characteristic are for a standard sensing object positioned midway through the rated sensing distance.

\*2 A sudden temperature rise even within the rated temperature range may degrade characteristics.

\*3 For the Sensor Head only without the preamplifier (-10 to 60°C). With no icing or condensation.

\*4 Do not operate in areas exposed to water vapor because the enclosure is not waterproof.

## Amplifier Units

Type		Advanced Models with Twin Outputs			Advanced Models with External Inputs	
		Pre-wired Model	Model with Wire-saving Connector	Model for Sensor Communications Unit	Pre-wired Model	Model with Wire-saving Connector
Model Item	NPN output	E2C-EDA11	E2C-EDA6	E2C-EDA0 *1	E2C-EDA21	E2C-EDA7
	PNP output	E2C-EDA41	E2C-EDA8		E2C-EDA51	E2C-EDA9
<b>Supply voltage</b>		12 to 24 VDC $\pm$ 10%, ripple (p-p): 10% max.				
<b>Power consumption</b>		1,080 mW max. (current consumption: 45 mA at power supply voltage of 24 VDC)				
<b>Control output</b>		Load power supply voltage: 26.4 VDC max.; NPN/PNP open collector output; load current: 50 mA max. (residual voltage: 1 V max.)				
<b>Response time</b>	<b>Super-high-speed mode *2</b>	150 $\mu$ s for operation and reset respectively		---	150 $\mu$ s for operation and reset respectively	
	<b>High-speed mode</b>	300 $\mu$ s for operation and reset respectively				
	<b>Standard mode</b>	1 ms for operation and reset respectively				
	<b>High-resolution mode</b>	4 ms for operation and reset respectively				
<b>Functions</b>	<b>Differential detection</b>	Switchable between single edge and double edge detection mode Single edge: Can be set to 300 $\mu$ s, 500 $\mu$ s, 1 ms, 10 ms, or 100 ms Double edge: Can be set to 500 $\mu$ s, 1 ms, 2 ms, 20 ms, or 200 ms.				
	<b>Timer function</b>	Select from OFF-delay, ON-delay, or one-shot timer. 1 ms to 5 s (1 to 20 ms set in 1-ms increments, 20 to 200 ms set in 10-ms increments, 200 ms to 1 s set in 100-ms increments, and 1 to 5 s set in 1 s-increments)				
	<b>Zero-reset</b>	Negative values can be displayed. Zero-reset is accompanied by a change of detection distance. After zero-reset, some threshold level may also cause a change of the indication by influence of other settings.				
	<b>Initial reset</b>	Settings can be returned to defaults as required.				
	<b>Mutual interference prevention</b>	Possible for up to 5 Units. *2 Intermittent oscillation method (Response time = (number of Units connected + 1) $\times$ 15 ms)				
	<b>Hysteresis settings</b>	Setting range: 10 to 2,000				
	<b>I/O settings</b>	Output setting (Select from channel 2 output, area output, self-diagnosis, or open circuit detection.)			Input setting (Select from teaching, fine positioning, zero-reset, synchronous detection.)	
<b>Digital display</b>		Select from the following: Incident level + threshold, incident level percentage + threshold, incident light peak level + incident light bottom level (updated with output), long bar display, incident level + peak hold, incident level + channel				
<b>Display orientation</b>		Switching between normal/reversed display is possible.				
<b>Ambient temperature *3</b>		Operating: When connecting 1 to 2 Units: $-10^{\circ}\text{C}$ to $55^{\circ}\text{C}$ , When connecting 3 to 5 Units: $-10^{\circ}\text{C}$ to $50^{\circ}\text{C}$ , When connecting 6 to 16 Units: $-10^{\circ}\text{C}$ to $45^{\circ}\text{C}$ When used in combination with an EDR6-F When connecting 3 to 4 Units: $-10^{\circ}\text{C}$ to $50^{\circ}\text{C}$ , When connecting 5 to 8 Units: $-10^{\circ}\text{C}$ to $45^{\circ}\text{C}$ , When connecting 9 to 16 Units: $-10^{\circ}\text{C}$ to $40^{\circ}\text{C}$ Storage: $-20^{\circ}\text{C}$ to $70^{\circ}\text{C}$ (with no icing)				
<b>Ambient humidity</b>		Operating/storage: 35% to 85% (with no condensation)				
<b>Insulation resistance</b>		20 M $\Omega$ min. (at 500 VDC)				
<b>Dielectric strength</b>		1,000 VAC at 50/60 Hz for 1 min				
<b>Vibration resistance (Destruction)</b>		10 to 55 Hz with a 1.5-mm double amplitude for 2 hours each in X, Y, and Z directions	10 to 150 Hz with a 0.7-mm double amplitude for 80 min each in X, Y, and Z directions	10 to 55 Hz with a 1.5-mm double amplitude for 2 hours each in X, Y, and Z directions		
<b>Shock resistance (Destruction)</b>		500 m/s <sup>2</sup> for 3 times each in X, Y, and Z directions	150 m/s <sup>2</sup> for 3 times each in X, Y, and Z directions	500 m/s <sup>2</sup> for 3 times each in X, Y, and Z directions		
<b>Degree of protection</b>		IEC60529 IP50				
<b>Connection method</b>		Pre-wired	Wire-saving connector	Connector for Sensor Communications Unit	Pre-wired	Wire-saving connector
<b>Weight (packed state)</b>		Approx. 100 g	Approx. 55 g	Approx. 55 g	Approx. 100 g	Approx. 55 g
<b>Material</b>	<b>Case</b>	PBT (polybutylene terephthalate)				
	<b>Cover</b>	Polycarbonate				

\*1 This model allow you to use an E3X-ECT EtherCAT Sensor Communications Unit or E3X-CRT CompoNet Sensor Communications Unit.

\*2 Communications functions, mutual interference prevention, and communications with the Mobile Console are all disabled if the detection mode is set to the super-high-speed mode.

\*3 The following temperature ranges apply for operation when an E3X-ECT or E3X-CRT Sensor Communications Unit is used with the E2C-EDA0: Groups of 1 or 2 Amplifier Units: 0 to  $55^{\circ}\text{C}$ , Groups of 3 to 5 Amplifier Units: 0 to  $50^{\circ}\text{C}$ , Groups of 6 to 16 Amplifier Units: 0 to  $45^{\circ}\text{C}$ , Groups of 17 to 30 Amplifier Units (with the E3X-ECT): 0 to  $40^{\circ}\text{C}$ .

The following temperature ranges apply when an E3X-ECT or E3X-CRT Sensor Communications Unit is used with the E2C-EDR6-F: Groups of 3 or 4 Amplifier Units: 0 to  $50^{\circ}\text{C}$ , Groups of 5 to 8 Amplifier Units: 0 to  $45^{\circ}\text{C}$ , Groups of 9 to 16 Amplifier Units: 0 to  $40^{\circ}\text{C}$ , Groups of 17 to 30 Amplifier Units (with the E3X-ECT): 0 to  $35^{\circ}\text{C}$ .

# Engineering Data (Reference Value)

## Sensing Distance vs. Display Values

E2C-EDR6-F

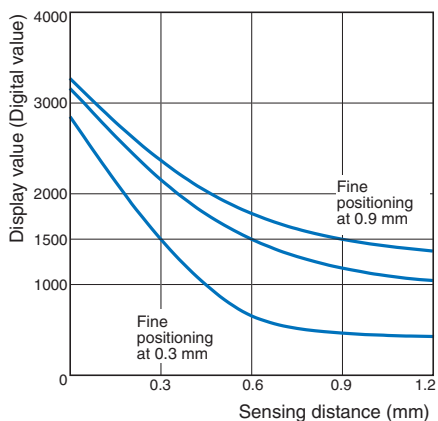

E2C-ED01(-□)

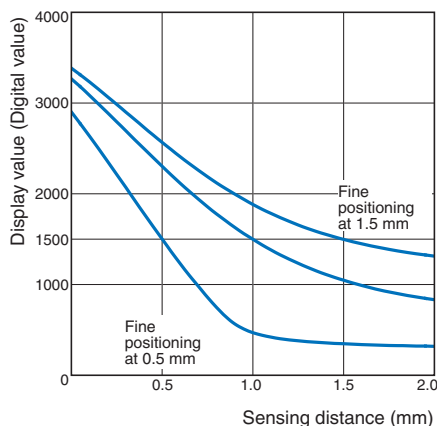

E2C-ED02(-□)/EM02(-□)

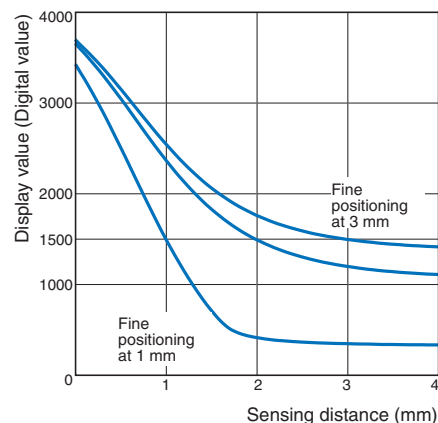

E2C-EM07(-□)

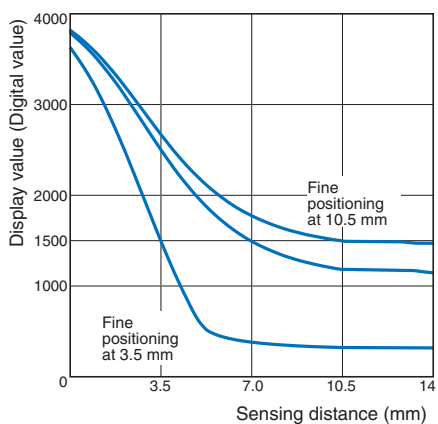

E2C-EV05(-□)

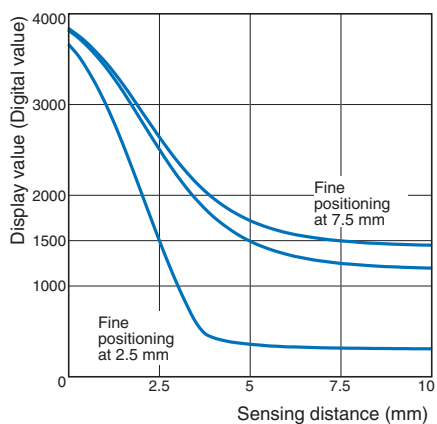

E2C-EM02H

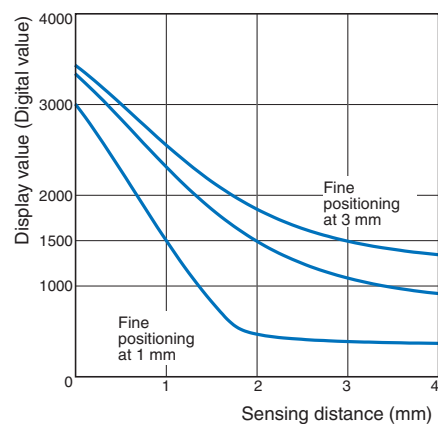

## Influence of Sensing Object Size and Material

E2C-EDR6-F

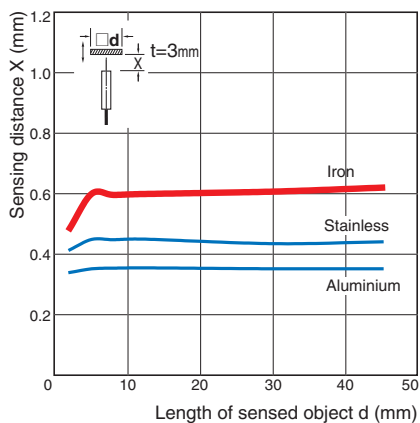

E2C-ED01(-□)

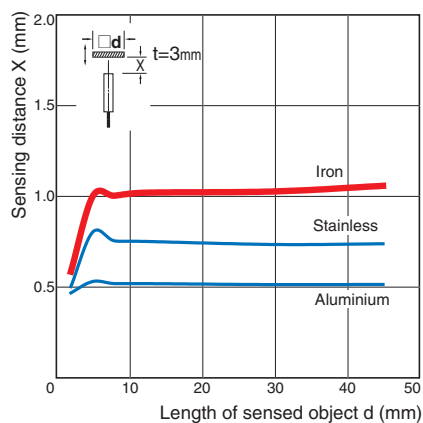

E2C-ED02(-□)/EM02(-□)

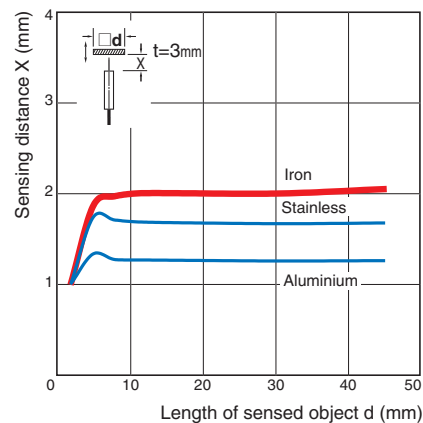

E2C-EM07(-□)

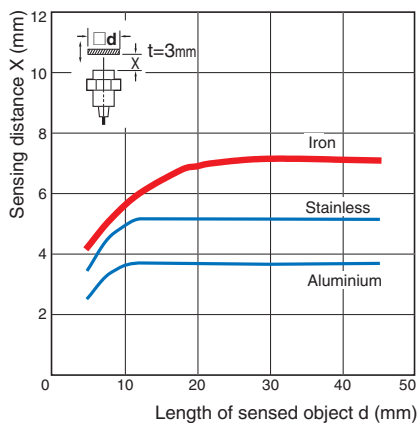

E2C-EV05(-□)

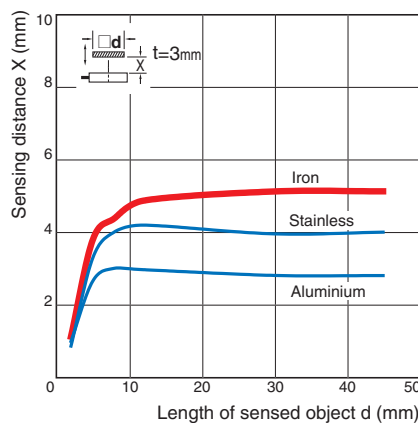

E2C-EM02H

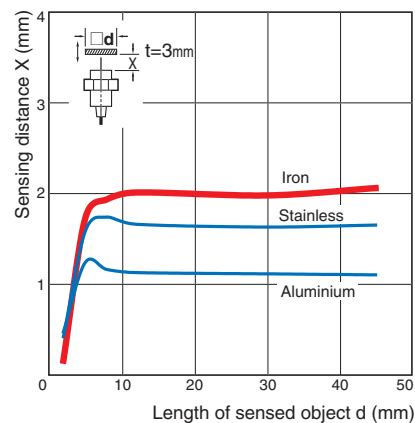

Influence of Sensor Head Temperature

E2C-EDR6-F

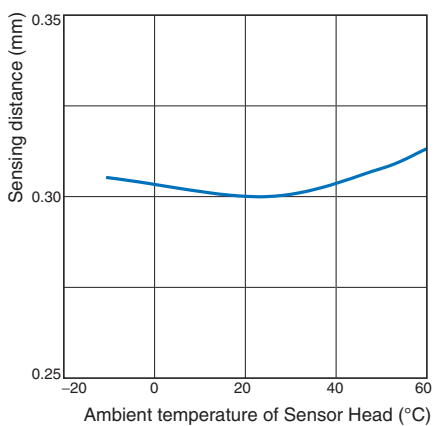

E2C-ED01(-□)

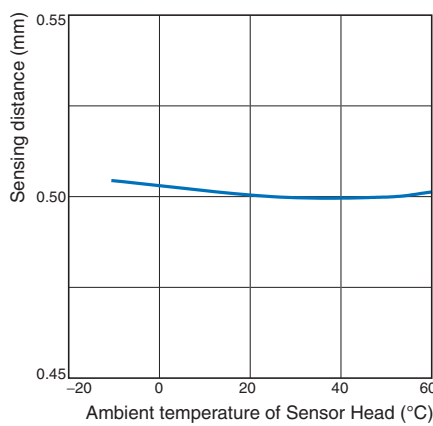

E2C-ED02(-□)/EM02(-□)

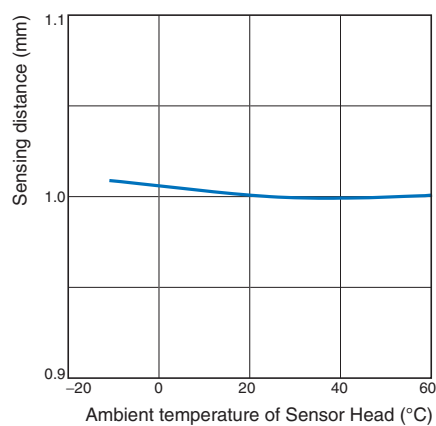

E2C-EM07(-□)

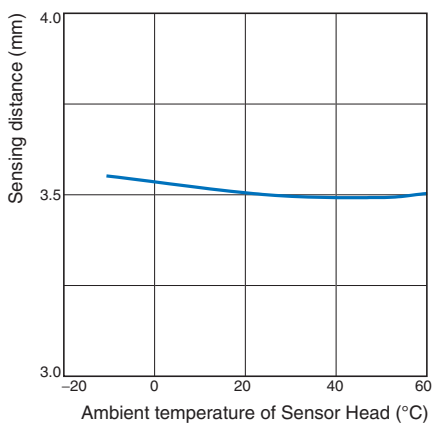

E2C-EV05(-□)

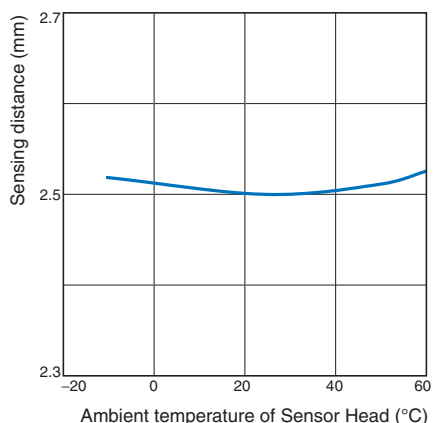

E2C-EM02H

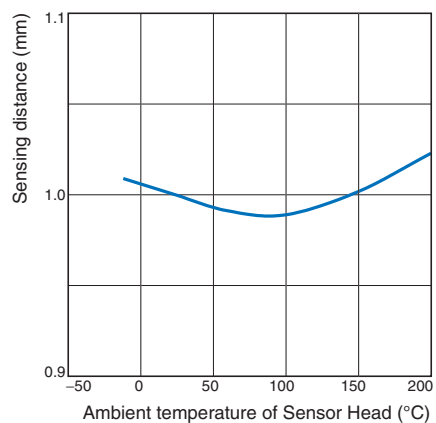

# I/O Circuit Diagrams

## NPN Output

Model	Operation mode	Timing chart	Mode selector	Output circuit
E2C-EDA11 E2C-EDA6	NO (Normally open)	Sensing object: Yes (ON), No (OFF) Operation indicator (orange): Lit (ON), Not lit (OFF) Output transistor: ON (ON), OFF (OFF) Load (relay, etc.): Operate (ON), Reset (OFF) (Between brown and black lines)	NO	
	NC (Normally closed)	Sensing object: Yes (OFF), No (ON) Operation indicator (orange): Lit (OFF), Not lit (ON) Output transistor: ON (OFF), OFF (ON) Load (relay, etc.): Operate (OFF), Reset (ON) (Between brown and black lines)	NC	
E2C-EDA21 E2C-EDA7	NO (Normally open)	Sensing object: Yes (ON), No (OFF) Operation indicator (orange): Lit (ON), Not lit (OFF) Output transistor: ON (ON), OFF (OFF) Load (relay, etc.): Operate (ON), Reset (OFF) (Between brown and black lines)	NO	
	NC (Normally closed)	Sensing object: Yes (OFF), No (ON) Operation indicator (orange): Lit (OFF), Not lit (ON) Output transistor: ON (OFF), OFF (ON) Load (relay, etc.): Operate (OFF), Reset (ON) (Between brown and black lines)	NC	

**Note: 1. Setting Areas for Twin-output Models**  
 Normally open: .....ON between the thresholds for Channel 1 and Channel 2  
 Normally closed: ..OFF between the thresholds for Channel 1 and Channel 2  
**2. Timing Charts for Timer Settings (T: Set Time)**

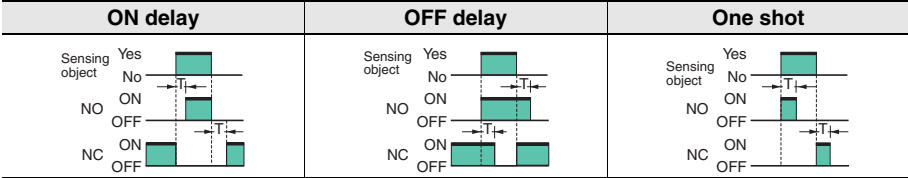



PNP Output

Model	Operation mode	Timing chart	Mode selector	Output circuit
E2C-EDA41 E2C-EDA8	NO (Normally open)	Sensing object: Yes (ON), No (OFF) Operation indicator (orange): Lit (ON), Not lit (OFF) Output transistor: ON (ON), OFF (OFF) Load (relay, etc.): Operate (ON), Reset (OFF)	NO	
	NC (Normally closed)	Sensing object: Yes (OFF), No (ON) Operation indicator (orange): Lit (OFF), Not lit (ON) Output transistor: ON (OFF), OFF (ON) Load (relay, etc.): Operate (OFF), Reset (ON)	NC	
E2C-EDA51 E2C-EDA9	NO (Normally open)	Sensing object: Yes (ON), No (OFF) Operation indicator (orange): Lit (ON), Not lit (OFF) Output transistor: ON (ON), OFF (OFF) Load (relay, etc.): Operate (ON), Reset (OFF)	NO	
	NC (Normally closed)	Sensing object: Yes (OFF), No (ON) Operation indicator (orange): Lit (OFF), Not lit (ON) Output transistor: ON (OFF), OFF (ON) Load (relay, etc.): Operate (OFF), Reset (ON)	NC	

**Note: 1.** Setting Areas for Twin-output Models  
 Normally open: .....ON between the thresholds for Channel 1 and Channel 2  
 Normally closed: ..OFF between the thresholds for Channel 1 and Channel 2  
**2.** Timing Charts for Timer Settings (T: Set Time)

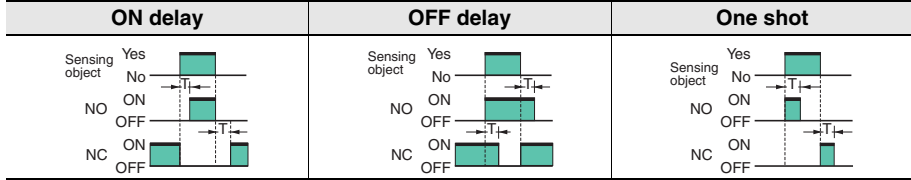

Nomenclature

Amplifier Units  
 Twin-output Models

(E2C-EDA11/EDA41/EDA6/EDA8/EDA0)

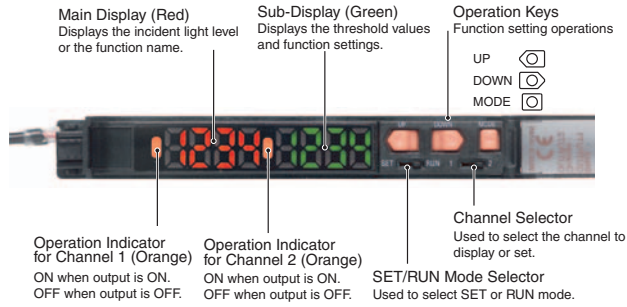

External-input Models

(E2C-EDA21/EDA51/EDA7/EDA9)

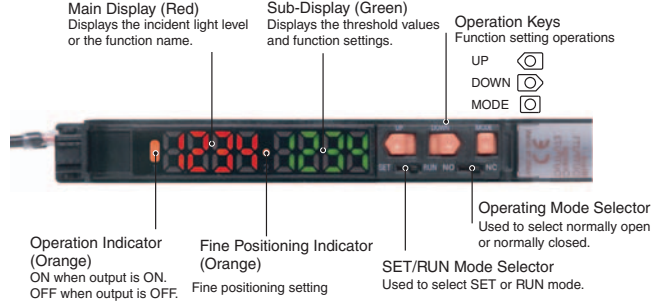

## Safety Precautions

Refer to *Warranty and Limitations of Liability*.

### WARNING

Do not use this product in any safety device used for the protection of human lives.



### Precautions for Correct Use

Do not use this product in operating atmospheres or environments outside the specified ratings.

## Amplifier Units

### Design

#### Power ON

The Sensor is ready to sense an object within 200 ms after turning the power ON. If the load and Sensor are connected to different power supplies, always turn ON the Sensor power first.

#### Cable

Use an external power cable of cross-section of 0.3 mm<sup>2</sup> or more for the Amplifier, and the total length of the cable must be 30 m or less.

## Connecting Sensor Heads

### Connecting and Disconnecting Sensor Heads

1. Open the protective cover.
2. Making sure that the lock button is up, insert the fibers all the way to the back of the Connector insertion opening.

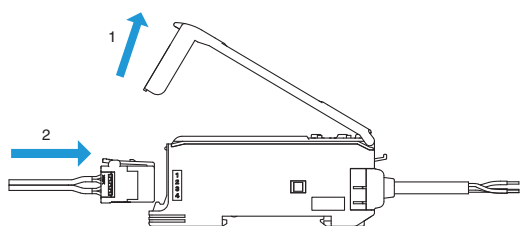

To disconnect the Sensor Head, pull out the fibers while pressing on the lock button.

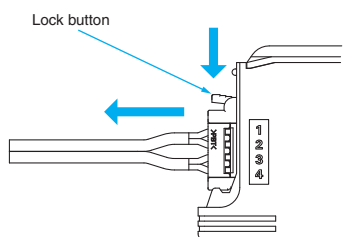

## Connecting and Disconnecting Wire-saving Connectors

### <Connecting Connectors>

1. Insert the Master or Slave Connector into the Amplifier Unit until it clicks into place.

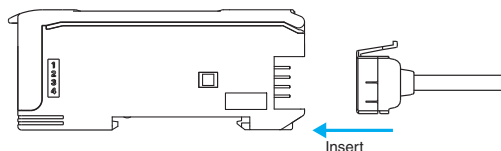

2. Apply the supplied seal to the non-connection surface of the Master/Slave Connector.

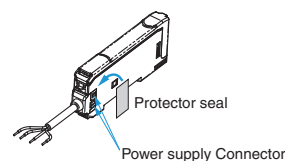

**Note:** Apply the seal to the grooved side.

### <Disconnecting Connectors>

1. Slide the Slave Amplifier Unit.
2. After the Amplifier Unit has been separated, press down on the lever on the Connector and remove it. (Do not attempt to remove Connectors without separating them from other Amplifier Units first.)

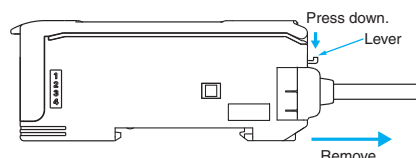

## Installing and Removing Amplifier Units

### <Installing Amplifier Units>

1. Install the Units one by one to the DIN rail.

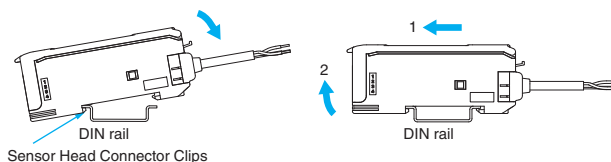

2. Slide one Unit toward the other, match the clips at the front ends, and then bring them together until they "click."

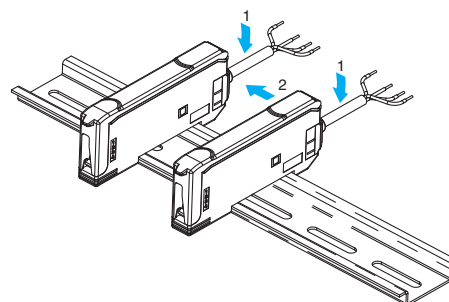

### <Removing Amplifier Units>

Slide one Unit away from the other and remove them one by one. (Do not remove the connected Units together from the DIN rail.)

- Note:**
1. When the Amplifier Units are connected to each other, the operable ambient temperature changes depending on the number of connected Amplifier Units. Check page 5 in *Rating and Specifications*.
  2. Before connecting or disconnecting the Units, always switch power OFF.

## End Plate Mounting (PFP-M)

Mount End Plates on Amplifier Units to avoid movement due to vibration. When a Mobile Console is installed, mount the End Plate facing as shown in the following diagram.

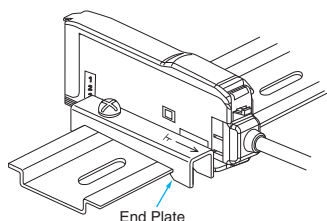

## Mounting a Communications Head for the Mobile Console

Leave a space of at least 20 mm on the left side of the Units for a Mobile Console Communications Head.

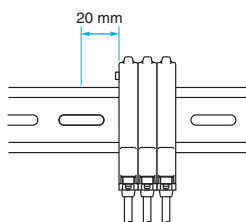

## EEPROM Write Error

If the data is not written to the EEPROM correctly due to a power failure or static-electric noise, initialize the settings using the keys on the Amplifier Unit.

## Optical Communications

When using more than one Amplifier Unit, mount the Units side-by-side. Do not slide or remove Units while they are in use.

## Miscellaneous

### Protective Cover

Be sure to put on the Protective Cover before use.

### Mobile Console

Use the E3X-MC11-SV2 Mobile Console for E2C-EDA-series Amplifier Units. Other Mobile Consoles, such as the E3X-MC11, cannot be used.

## Sensor Head and Amplifier Unit Connection

Be sure to use only specified Sensor Head and Amplifier Unit combinations. The E3C-LDA-series Photoelectric Sensor with Separate Digital Amplifier is not compatible, and the E2C-EDA must not be used with products from that series.

## Warm-up

The digital display will slowly change until the circuits stabilize after the power is turned ON. It takes about 30 minutes after the power is turned ON before the E2C-EDA is ready to sense.

## Maintenance Inspection

- Be sure to turn OFF the power before adjusting, connecting, or disconnecting the Sensor Head.
- Do not use thinner, benzene, acetone, or kerosene to clean the Sensor Head or Amplifier Unit.

## Sensor Heads Mounting

### Mounting Sensor Heads

- Use the dimensions from the following table to mount unthreaded cylindrical models (E2C-ED-□□). Do not tighten screws with torque exceeding 0.2 N·m when mounting Sensor Heads.

Model	Tightening range A
E2C-EDR6-F	9 to 18 mm
E2C-ED01□□	9 to 18 mm
E2C-ED02□□	11 to 22 mm

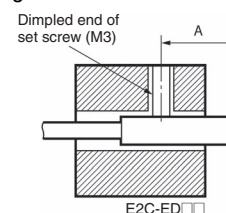

- Use the torque given in the following table to tighten threaded cylindrical models (E2C-EM□□).

Model	Tightening torque
E2C-EM02□□	15 N·m max.
E2C-EM07M□□	15 N·m max.
E2C-EM02H□□	5.9 N·m max.

- Do not use torque exceeding 0.5 N·m to tighten screws when mounting flat models (E2C-EV□□).
- Use a bending radius of at least 8 mm for the Sensor Head cable.
- Use only the special extension cable to extend the cable between the Sensor Head and the Amplifier Unit.

Model	Cable length
E22-XC2R	2 m
E22-XC7R	7 m

## Effects of Surrounding Metal

- Provide a minimum distance between the Sensor and the surrounding metal as shown in the table below.

### Effects of Surrounding Metal (Units: mm)

Model	Counterbore A	Protrusion B
E2C-EDR6-F	3.1	0
E2C-ED01□□	5.4	0
E2C-ED02□□	8	0
E2C-EM02□□	10	0
E2C-EM07M□□	35	20
E2C-EV05□□	14 × 30	4.8
E2C-EM02H□□	12	0

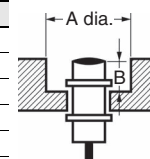

## Mutual Interference

- If more than one Sensor Head is installed face to face or in parallel, make sure that the distances between two Units adjacent to each other are the same as or larger than the corresponding values shown in the following table.
- The distance between Sensor Heads may be narrower than specified with these Sensors because the Mutual Interference Prevention Function is used for optical communications between the Amplifier Units.

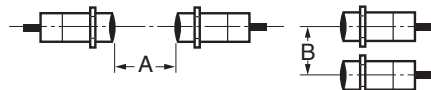

### Mutual Interference

(Units: mm)

Model	Face-to-face arrangement A	Parallel arrangement B	Face-to-face arrangement using the Mutual Interference Prevention Function A'	Parallel arrangement using the Mutual Interference Prevention Function B'
E2C-EDR6-F	14	10	3.5	3.1
E2C-ED01□□	45	20	9	5.4
E2C-ED02□□	35	30	21	8 *
E2C-EM02□□	36	30	21	10 *
E2C-EM07M□□	140	120	35	18 *
E2C-EV05□□	65	30	21	14 *
E2C-EM02H□□	45	30	21	12 *

\* Mutual interference does not occur for close-proximity mounting when the Mutual Interference Prevention Function is effective.

Dimensions

Tolerance class IT16 applies to dimensions in this data sheet unless otherwise specified.

Sensor Heads

E2C-EDR6(-F)

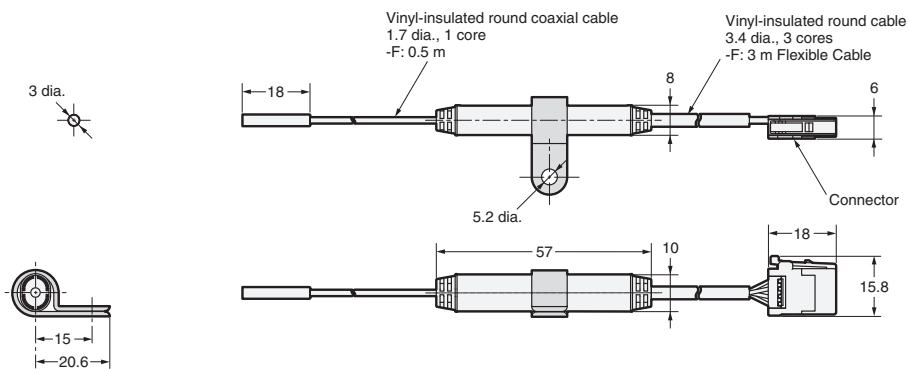

E2C-ED01(-F)

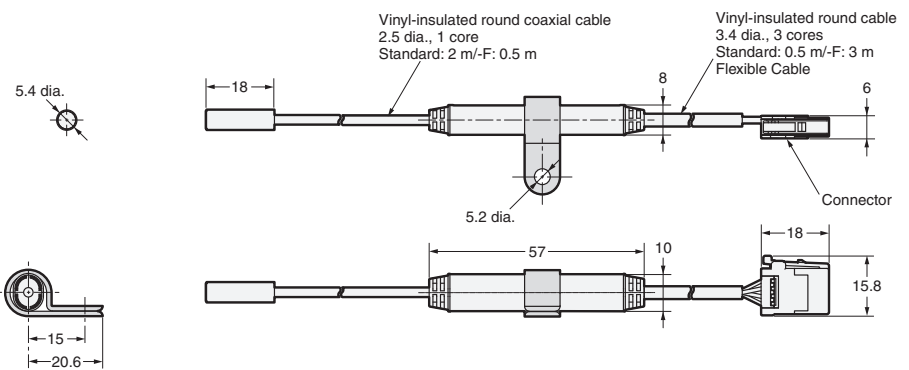

E2C-ED02(-F)

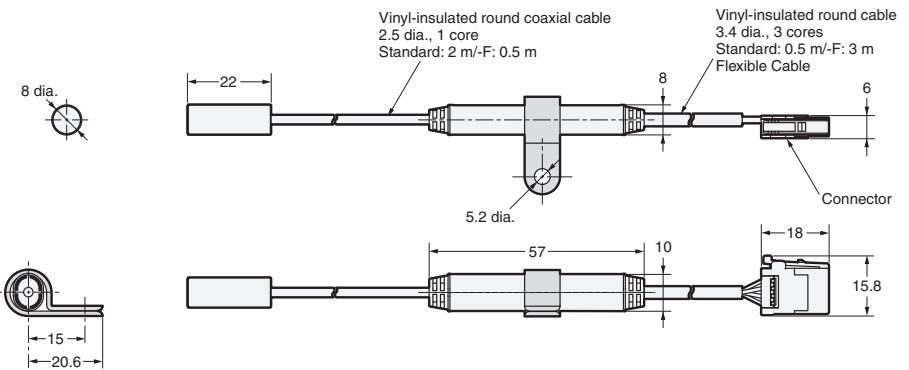

E2C-EM02(-F)

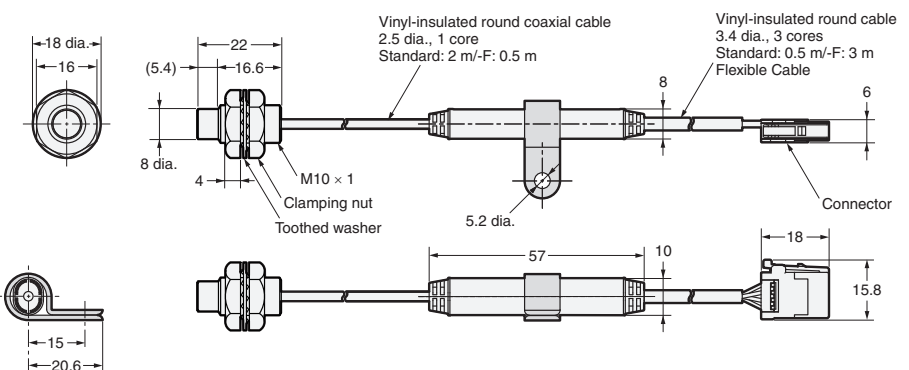

E2C-EM07M(-F)

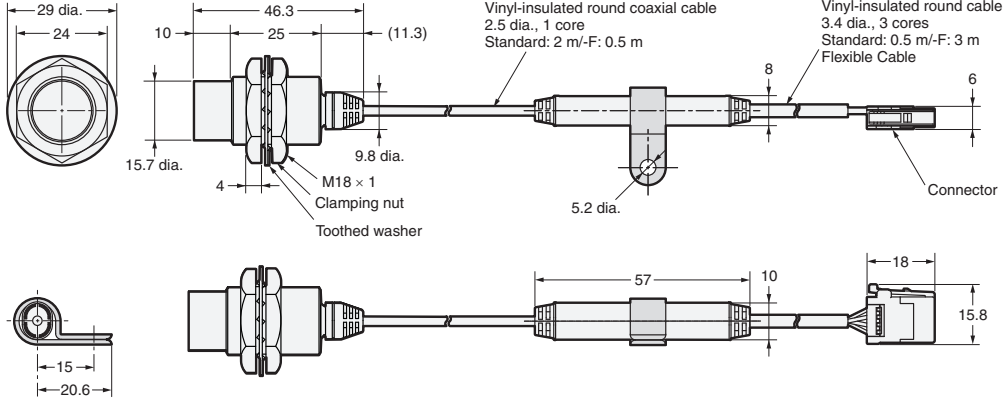

E2C-EV05(-F)

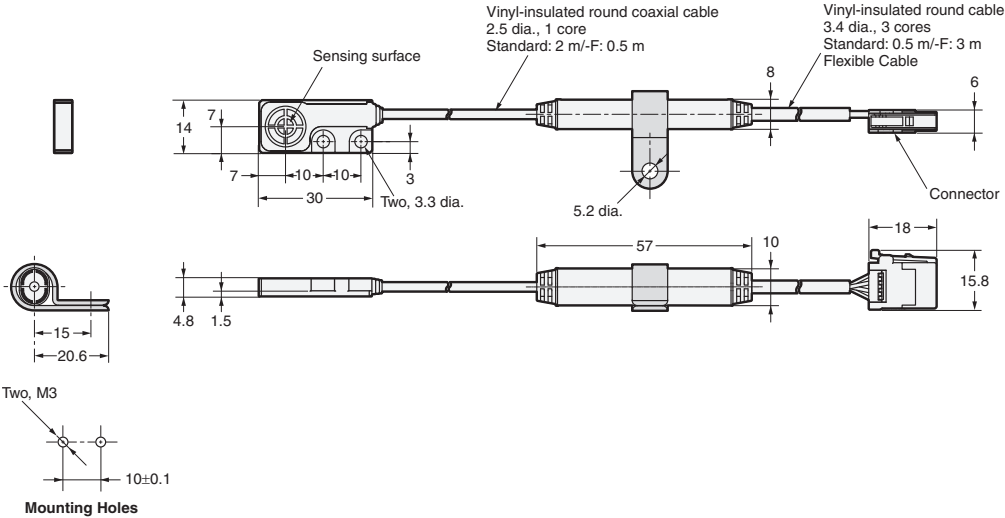

E2C-EM02H

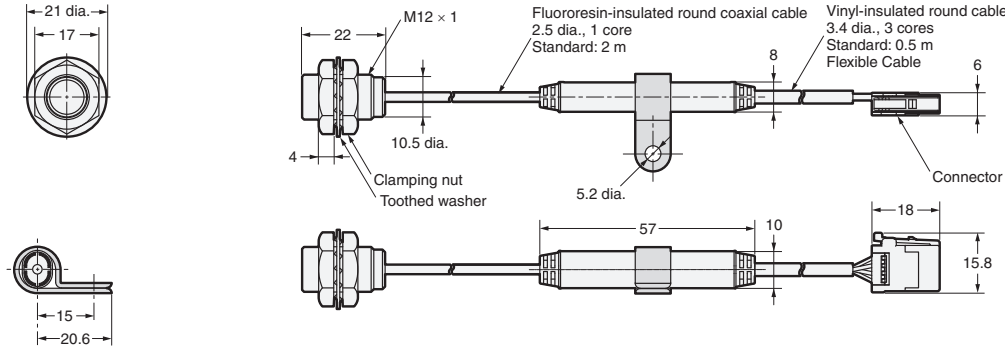

Extension Cables for Sensors Head

E22-XC2R  
E22-XC7R

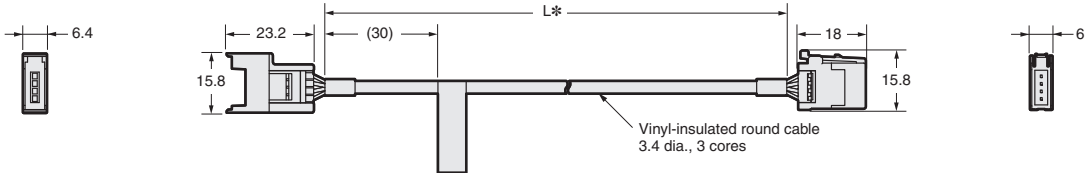

\* Cable Specifications

Specifications	L
2 m	2,000 <sup>+50</sup> <sub>0</sub>
7 m	7,000 <sup>+200</sup> <sub>0</sub>

# Amplifier Units

## Amplifier Units with Cables

- E2C-EDA11
- E2C-EDA21
- E2C-EDA41
- E2C-EDA51

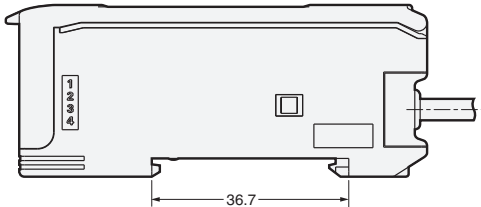
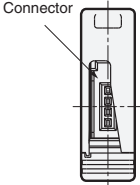
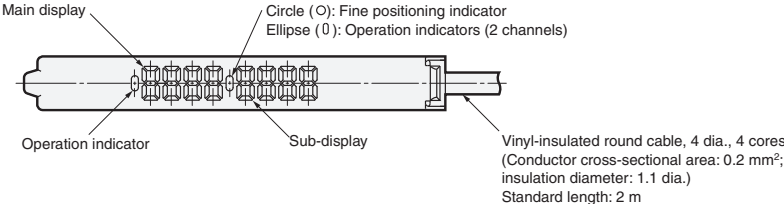

### With Mounting Bracket Attached

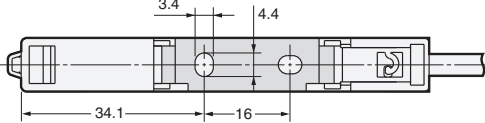
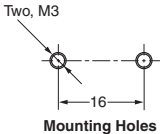
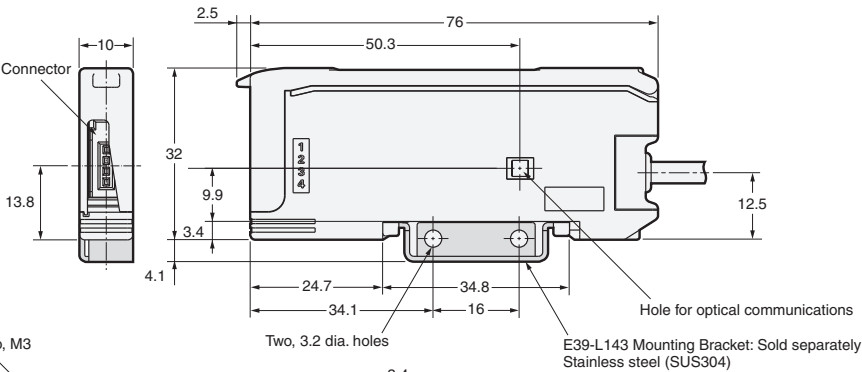
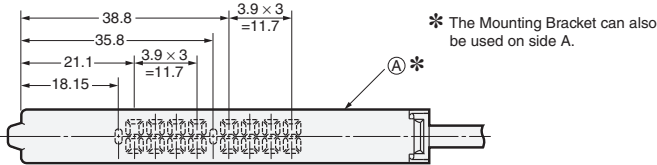

Amplifier Units with Wire-saving Connectors

- E2C-EDA6
- E2C-EDA7
- E2C-EDA8
- E2C-EDA9

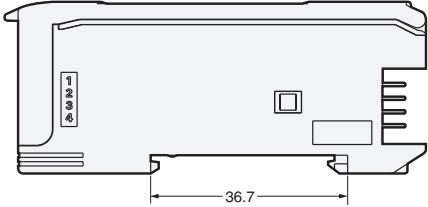
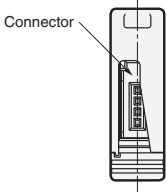
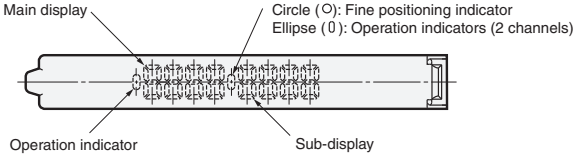

With Mounting Bracket Attached

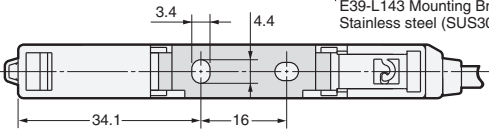
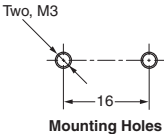
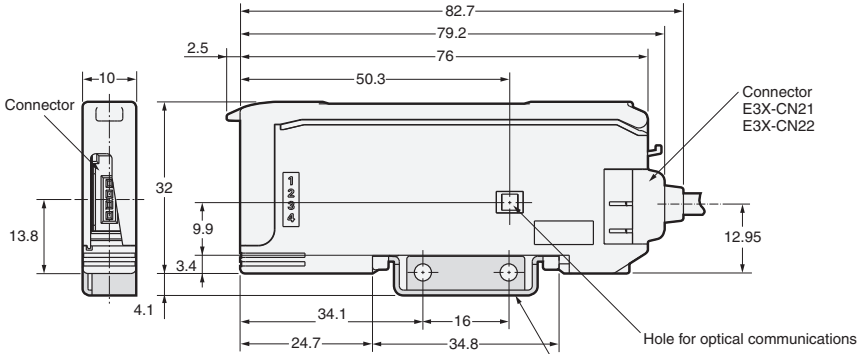
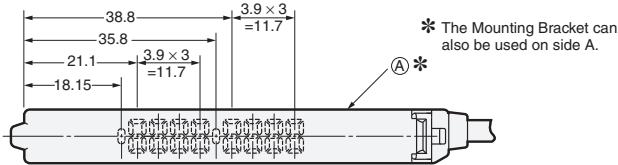

E39-L143 Mounting Bracket: Sold separately  
Stainless steel (SUS304)

**Amplifier Unit with Connector for  
Sensor Communications Unit  
E2C-EDA0**

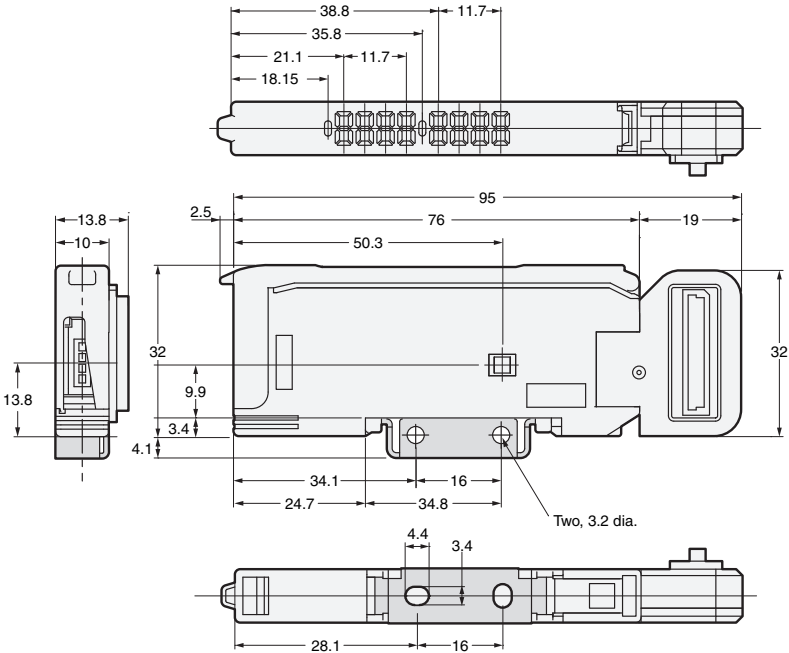

**Amplifier Unit Connectors**

Refer to *E3X-DA-S/MDA* for details.

**Mobile Console**

Refer to *E3X-DA-S/MDA* for details.

**Accessories (Order Separately)**

**Mounting Brackets**

Refer to *E39-L* for details.

**End Plate**

Refer to *DIN rail* for details.



## Terms and Conditions Agreement

### Read and understand this catalog.

Please read and understand this catalog before purchasing the products. Please consult your OMRON representative if you have any questions or comments.

### Warranties.

(a) Exclusive Warranty. Omron's exclusive warranty is that the Products will be free from defects in materials and workmanship for a period of twelve months from the date of sale by Omron (or such other period expressed in writing by Omron). Omron disclaims all other warranties, express or implied.

(b) Limitations. OMRON MAKES NO WARRANTY OR REPRESENTATION, EXPRESS OR IMPLIED, ABOUT NON-INFRINGEMENT, MERCHANTABILITY OR FITNESS FOR A PARTICULAR PURPOSE OF THE PRODUCTS. BUYER ACKNOWLEDGES THAT IT ALONE HAS DETERMINED THAT THE PRODUCTS WILL SUITABLY MEET THE REQUIREMENTS OF THEIR INTENDED USE.

Omron further disclaims all warranties and responsibility of any type for claims or expenses based on infringement by the Products or otherwise of any intellectual property right. (c) Buyer Remedy. Omron's sole obligation hereunder shall be, at Omron's election, to (i) replace (in the form originally shipped with Buyer responsible for labor charges for removal or replacement thereof) the non-complying Product, (ii) repair the non-complying Product, or (iii) repay or credit Buyer an amount equal to the purchase price of the non-complying Product; provided that in no event shall Omron be responsible for warranty, repair, indemnity or any other claims or expenses regarding the Products unless Omron's analysis confirms that the Products were properly handled, stored, installed and maintained and not subject to contamination, abuse, misuse or inappropriate modification. Return of any Products by Buyer must be approved in writing by Omron before shipment. Omron Companies shall not be liable for the suitability or unsuitability or the results from the use of Products in combination with any electrical or electronic components, circuits, system assemblies or any other materials or substances or environments. Any advice, recommendations or information given orally or in writing, are not to be construed as an amendment or addition to the above warranty.

See <http://www.omron.com/global/> or contact your Omron representative for published information.

### Limitation on Liability: Etc.

OMRON COMPANIES SHALL NOT BE LIABLE FOR SPECIAL, INDIRECT, INCIDENTAL, OR CONSEQUENTIAL DAMAGES, LOSS OF PROFITS OR PRODUCTION OR COMMERCIAL LOSS IN ANY WAY CONNECTED WITH THE PRODUCTS, WHETHER SUCH CLAIM IS BASED IN CONTRACT, WARRANTY, NEGLIGENCE OR STRICT LIABILITY.

Further, in no event shall liability of Omron Companies exceed the individual price of the Product on which liability is asserted.

### Suitability of Use.

Omron Companies shall not be responsible for conformity with any standards, codes or regulations which apply to the combination of the Product in the Buyer's application or use of the Product. At Buyer's request, Omron will provide applicable third party certification documents identifying ratings and limitations of use which apply to the Product. This information by itself is not sufficient for a complete determination of the suitability of the Product in combination with the end product, machine, system, or other application or use. Buyer shall be solely responsible for determining appropriateness of the particular Product with respect to Buyer's application, product or system. Buyer shall take application responsibility in all cases.

NEVER USE THE PRODUCT FOR AN APPLICATION INVOLVING SERIOUS RISK TO LIFE OR PROPERTY OR IN LARGE QUANTITIES WITHOUT ENSURING THAT THE SYSTEM AS A WHOLE HAS BEEN DESIGNED TO ADDRESS THE RISKS, AND THAT THE OMRON PRODUCT(S) IS PROPERLY RATED AND INSTALLED FOR THE INTENDED USE WITHIN THE OVERALL EQUIPMENT OR SYSTEM.

### Programmable Products.

Omron Companies shall not be responsible for the user's programming of a programmable Product, or any consequence thereof.

### Performance Data.

Data presented in Omron Company websites, catalogs and other materials is provided as a guide for the user in determining suitability and does not constitute a warranty. It may represent the result of Omron's test conditions, and the user must correlate it to actual application requirements. Actual performance is subject to the Omron's Warranty and Limitations of Liability.

### Change in Specifications.

Product specifications and accessories may be changed at any time based on improvements and other reasons. It is our practice to change part numbers when published ratings or features are changed, or when significant construction changes are made. However, some specifications of the Product may be changed without any notice. When in doubt, special part numbers may be assigned to fix or establish key specifications for your application. Please consult with your Omron's representative at any time to confirm actual specifications of purchased Product.

### Errors and Omissions.

Information presented by Omron Companies has been checked and is believed to be accurate; however, no responsibility is assumed for clerical, typographical or proofreading errors or omissions.