

Lighted Pushbutton Switch

A3PJ

Rectangular Type with 18.9 mm × 26.1 mm Button

- Back-projected LED offers longer life, wider viewing, and greater viewing distance
- Replaceable LED T-1-3/4 standardized for ease of maintenance
- Two choices of contacts to match load requirements: silver and gold
- Snap-action offers high reliability
- Lamped type also available
- Button lockable
- LED protected by a current-limiting resistor

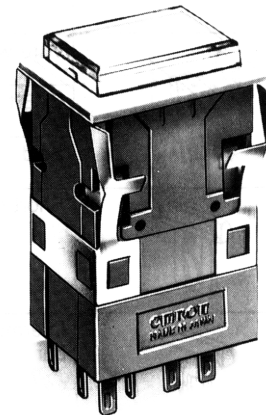

Ordering Information

Individually order indicators and switch units.

LED-lighted Type

Indicator Unit*

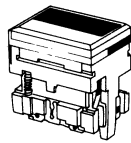

Pushbutton Switch
A3P□-5□□□-□□E
Indicator
M2P□-5□□□-□□E

Switch Unit**

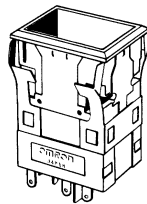

Pushbutton Switch
A3P□-7□□□-□
Indicator
M2P□-7□□□-□

* The LED-lighted type has a built-in LED chip (which lights either in color or white).

**The switch unit can be used with both the LED and incandescent lamp.

LED Ball-lighted Type

Indicator Unit

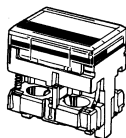

Pushbutton Switch
A3PJ-502□
Indicator

LED

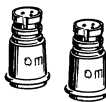

DC-operated
SLL-□□E□
AC-/DC-operated
SLL-□□EAC□

Switch Unit*

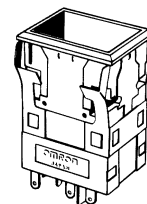

Pushbutton Switch
A3PJ-7□□□-□
Indicator
M2PJ-7□□□-□

* The Switch unit can be used with either the LED-lighted type, LED ball-lighted type, or incandescent lamp-lighted type pushbutton unit

Incandescent Lamp-lighted Type

Indicator Unit

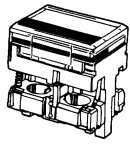

Pushbutton Switch
A3PJ-501□
Indicator
M2PJ-501□

Incandescent Lamp



Standard
SLL-□□
Power-saving
SLL-□□H

Switch Unit*

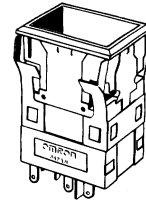

Pushbutton Switch
A3PJ-7□□□-□
Indicator
M2PJ-7□□□-□

* The Switch unit can be used with either the LED-lighted type, LED ball-lighted type, or incandescent lamp-lighted type pushbutton unit.









LED-lighted Type

Switch Units

Function	Contact & output form		Momentary action	Alternate action
Switch indication unit (switching and indicating functions)	Silver alloy contact	SPDT	A3PJ-7010-1	A3PJ-7020-1
		DPDT	A3PJ-7030-1	A3PJ-7040-1
	Gold alloy contact	SPDT	A3PJ-7050-1	A3PJ-7060-1
		DPDT	A3PJ-7070-1	A3PJ-7080-1
Indicator unit (indicating function only)			M2PJ-7010-1	

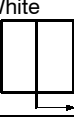
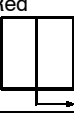
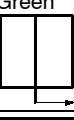
Note: The switch unit is supplied with a black flange and a spring mounting clip.

Display Screen Units (Transmitted Color)

Screen pattern & color		For switch indicator unit	For indicator unit	
Single screen type (solid color)		White	A3PJ-5701-□□E	M2PJ-5701-□□E
		Red	A3PJ-5702-□□E	M2PJ-5702-□□E
		Green	A3PJ-5703-□□E	M2PJ-5703-□□E
		Orange	A3PJ-5706-□□E	M2PJ-5706-□□E
2-split screen type (Horizontal)		White	A3PJ-5711-□□E	M2PJ-5711-□□E
		Red	A3PJ-5712-□□E	M2PJ-5712-□□E
		Green	A3PJ-5713-□□E	M2PJ-5713-□□E
		Orange	A3PJ-5716-□□E	M2PJ-5716-□□E
		White	A3PJ-5721-□□E	M2PJ-5721-□□E
		Red	A3PJ-5722-□□E	M2PJ-5722-□□E
		Green	A3PJ-5723-□□E	M2PJ-5723-□□E
		Orange	A3PJ-5726-□□E	M2PJ-5726-□□E
		White	A3PJ-5731-□□E	M2PJ-5731-□□E
		Red	A3PJ-5732-□□E	M2PJ-5732-□□E
		Green	A3PJ-5733-□□E	M2PJ-5733-□□E
		Orange	A3PJ-5736-□□E	M2PJ-5736-□□E
2-split screen type (Vertical)		Refer to the LED ball type		
				
				
3-split screen type (Horizontal)				
3-split screen type (Vertical)				
4-split screen type				

- Note:**
- The display screen unit incorporates a lens, a transparent legend plate, a plunger, a colored plate and LED(s). The split screen type includes a light baffle in addition to the above items.
 - When placing your order for the display screen unit, fill one of the following rated voltage codes in □□ of the part number.

Rated voltage	Voltage code
5 VDC:	05
12 VDC:	12
24 VDC:	24
 - When placing your order for the lamp type lighted pushbutton switch, refer to the "Ordering Information-Lamp types" section below.
 - When requiring a projected color type, refer to the LED ball type which is supplied with four color plates (white, red, green, and orange).

When placing your order for the lamp type and LED ball type A3PJ, specify the required numbers of the switch units, display screen units, and lamps or LEDs, according to the following tables.







Lamp types

Switch Units

Function	Construction Contact & output form		Momentary action	Alternate action
Switch indication unit (switching and indicating functions)	Silver alloy contact	SPDT	A3PJ-7010-1	A3PJ-7020-1
		DPDT	A3PJ-7030-1	A3PJ-7040-1
	Gold alloy contact	SPDT	A3PJ-7050-1	A3PJ-7060-1
		DPDT	A3PJ-7070-1	A3PJ-7080-1
Indicator unit (indicating function only)			M2PJ-7010-1	

Note: The switch unit is supplied with a black flange and a spring mounting clip.

Display Screen Units

Screen pattern	For switch-indicator unit	For indicator unit
Single screen 	A3PJ-5011	M2PJ-5011
2-split screen (Horizontal) 	A3PJ-5012	M2PJ-5012
2-split scree (Vertical) 	A3PJ-5013	M2PJ-5013
3-split screen (Horizontal) 	A3PJ-5014	M2PJ-5014
3-split screen (Vertical) 	A3PJ-5015	M2PJ-5015
4-split screen 	A3PJ-5016	M2PJ-5016

Note: The display screen unit consists of a lens, a legend plate, a plunger, a lamp holder, 5 colored plates (white, red, green, blue, and yellow) and light baffle (for other than the single screen type).

Lamps (Standard)

Operating voltage	Rated voltage	Rated current	Model
5 V	6 V	200 mA	SLL-06
12 V	14 V	80 mA	SLL-14
24 V	28 V	40 mA	SLL-28

Lamps (Microload)

Operating voltage	Rated voltage	Rated current	Model
5 V	6 V	100 mA	SLL-06H
12 V	14 V	40 mA	SLL-14H
24 V	28 V	25 mA	SLL-28H

- Note:**
- Commercially available 1 W lamps can also be used, provided the base socket conforms to T-13/4 sizing. For single screen and 2-split screen types, 2 lamps will be used. However, for the 3-split and 4-split screen types, 4 special Omron lamps (listed under Microload above) are required to reduce current draw, and heat output.
 - Note that application of 80% of the rated voltage to the lamp is advantageous in terms of service life and heat generation.
 - When a dark current is to be conducted through the lamps to suppress inrush current, allow 20 to 30% of the rated current to flow.

Number of Necessary Incandescent Lamps

Model	Split	Lamp	No. of lamps
A3PJ M2PJ	Non-split	Standard	2
	2-split (Horizontal) 2-split (Vertical) 3-split 4-split	Power-saving	4







LED-ball Type

Switch Units

Function	Construction Contact & output form		Momentary action	Alternate action
Switch indication unit (switching and indicating functions)	Silver alloy contact	SPDT	A3PJ-7010-1	A3PJ-7020-1
		DPDT	A3PJ-7030-1	A3PJ-7040-1
	Gold alloy contact	SPDT	A3PJ-7050-1	A3PJ-7060-1
		DPDT	A3PJ-7070-1	A3PJ-7080-1
Indicator unit (indicating function only)			M2PJ-7010-1	

Note: The switch unit is supplied with a black flange and a spring mounting clip.

Display Screen Unit (LED ball is Not Built-in.)

Split	Screen pattern	Pushbutton unit	Indicator
Non-split		A3PJ-5021	M2PJ-5021
2-split (Horizontal)		A3PJ-5022	M2PJ-5022
2-split (Vertical)		A3PJ-5023	M2PJ-5023
3-split (Horizontal)		A3PJ-5024	M2PJ-5024
3-split (Vertical)		A3PJ-5025	M2PJ-5025
4-split		A3PJ-5026	M2PJ-5026

LED Ball Ratings

Color	White	Red	Yellow	Green	
Applicable lens color	White	Red	Yellow	Green	
Operating voltage	5 VDC	SLL-05EW	SLL-05ER	SLL-05EY	SLL-05EG
	12 VDC	SLL-12EW	SLL-12ER	SLL-12EY	SLL-12EG
	24 VDC	SLL-24EW	SLL-24ER	SLL-24EY	SLL-24EG

Note: The white LEDs are applicable to projected color.

LED Ball Ratings

Rated voltage	current (mA)	Operating voltage range
5 VDC	30 mA	5 VDC \pm 5%
6 VDC	30 mA	6 VDC \pm 5%
12 VDC	15 mA	12 VDC \pm 5%
24 VDC	12.5 mA	24 VDC \pm 5%

Number of Necessary LED Balls

Model	Split	Lamp	No. of lamps
A3PJ	Non-split	LED ball	4
M2PJ	2-, 3-, 4-split		4

Specifications

Ratings

Silver Alloy Contacts (for Power Loads)

Rated voltage (V)	Non-inductive load (A)				Inductive load (A)			
	Resistive load		Lamp load		Inductive load		Motor load	
	NC	NO	NC	NO	NC	NO	NC	NO
125 VAC	5		0.7		3		1.3	
250 VAC	3		0.5		2		0.8	
8 VDC	5		2		4		3	
14 VDC	5		2		4		3	
30 VDC	4		2		3		3	
125 VDC	0.4		0.05		0.4		0.05	
250 VDC	0.2		0.03		0.2		0.03	

Note: 1. Inductive load: power factor = 0.4; time constant: 7 ms

2. Lamp load has an inrush current of 10 times the steady-state current.
Motor load has an inrush current of 6 times the steady-state current.

Gold Alloy Contacts (for Very Small Loads)

Switching capacity	0.1 A, 30 VDC/125 VAC (resistive load)
--------------------	--

LED Chip Ratings

Rated voltage	current (mA)		Operating voltage range
	Single screen type	2-split screen type	
5 VDC	80	40 \times 2	5 V \pm 5%
12 VDC	40	20 \times 2	12 V \pm 5%
24 VDC	20	13 \times 2	24 V \pm 5%

Characteristics

Operating frequency	Mechanical: 120 operations/minute max. Electrical: 30 operations/minute max.
Operating force	Momentary action: 600 g max. Alternate action: 700 g max.
Insulation resistance	100 M Ω min. (at 500 VDC)
Dielectric strength	1,000 VAC, 50/60 Hz for 1 minute between terminals of same polarity 2,000 VAC, 50/60 Hz for 1 minute between terminals of different polarity, between current-carrying metal part and ground, and between each terminal and non-current-carrying metal part
Vibration	Malfunction durability: 10 to 55 Hz, 1.5 mm double amplitude
Shock	Mechanical durability: 200 m/s ² (20 G)
Ambient temperature	Operating: -10°C to 40°C
Humidity	35 to 85% RH max.
Life expectancy	Mechanical: Momentary-action type: 1,000,000 operations min. Alternate-action type: 200,000 operations min. Electrical action type: 100,000 operations min. (see note below.)
Weight	Approx. 20 g to 24.5 g

Note: With the alternate action type, one operation cycle consists of set and reset actions.

Approved by Standards

UL (File No. E41515)

CSA (File No. LR45258)

Silver contact type: 5 A, 125 VAC
3 A, 250VAC

Gold alloy contact type: 0.1 A, 30 VDC
0.1 A, 125 VAC

Dimensions

Unless otherwise specified, a tolerance of ± 0.4 mm applies to all dimensions.

A3PJ (M2PJ)

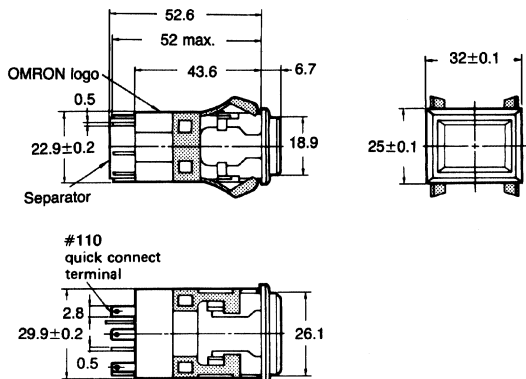

A3PJ (M2PJ) with Seal Cover

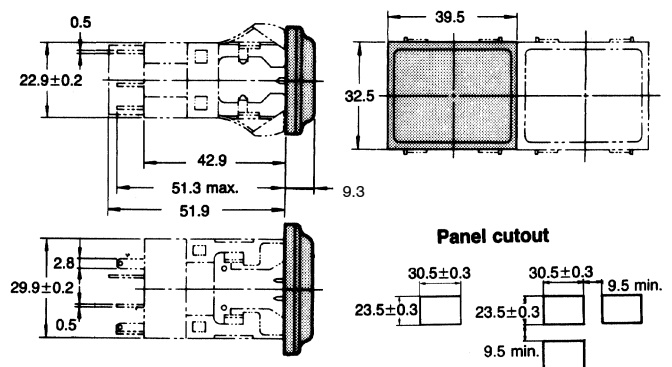

Note: When the seal cover is employed, neither barrier nor switch guard can be attached to the switch unit.

A3PJ with Switch Guard

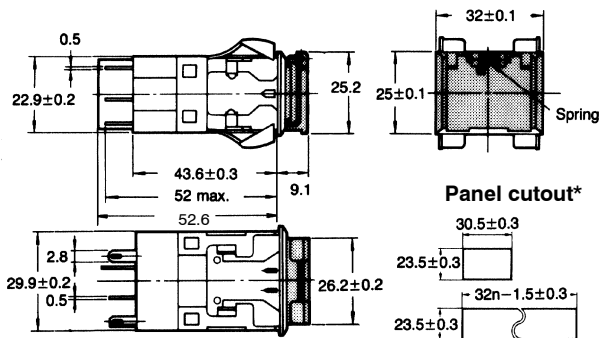

Socket (See Accessories.) PCB Terminal Dimensions

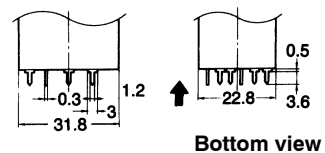

Mounting Holes (Bottom View)

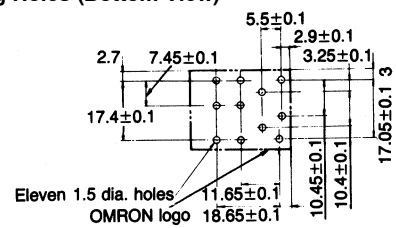

* When the flange mount type switches are arranged in the vertical multiple mounting style, no switch guard can be used. When a switch guard is employed, no seal cover can be attached to the switch unit.

Assembly/Disassembly

1. Locking/Unlocking Positive Lens Lock Mechanism

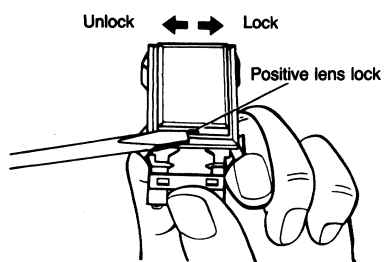

2. Mounting Display Screen Unit

With the OMRON logo on the switch unit faced upward, and the LED contact piece of the display screen unit positioned upward, align the split on each side of the display screen unit with the projections inside the switch unit, and push the display screen unit into the switch unit.

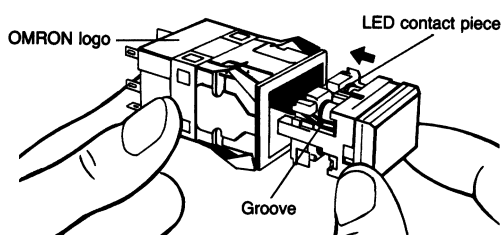

3. Removing/Mounting Lens

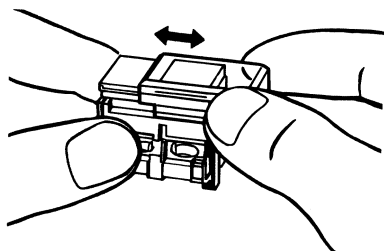

4. Mounting Light Baffle (Split Screen Type Only)

While holding the plunger case of the display screen unit, insert the light baffle into the interior groove of the plunger case from above.

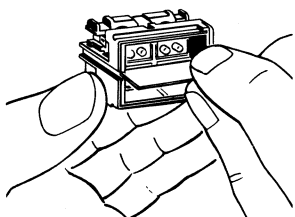

5. Mounting Colored Plate

After mounting the light baffle, place the colored plate on the plunger case with the dull side of the colored plate faced downward. Be sure that the projection on the upper surface of the colored plate faces outward.

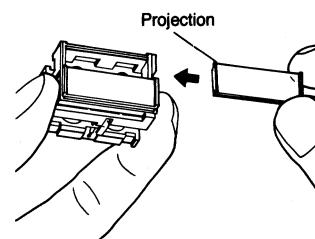

6. Mounting Switch Onto Panel

• Individual Mounting

When the mounting switch unit, push the switch unit into the panel cutout from front of the mounting panel by holding the switch unit with the logo mark "OMRON" faced downward. Since the mounting panel has some elasticity, the switch unit snaps into the panel with only a single push.

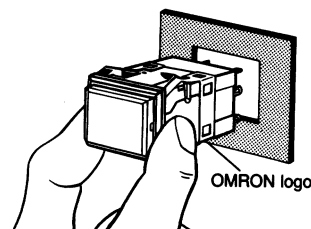

• Multiple Mounting

When mounting a number of switch units in line on the panel, use the mounting barriers at both ends of the panel cutout and insert the spacing barrier in between the two switch units. Push all the connected switch units together into the panel cutout while holding the mounting barriers at both ends.

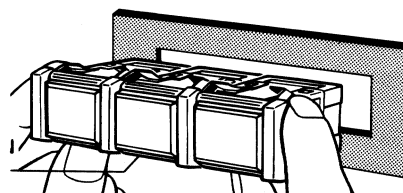

7. Mounting Flange, Barriers and Replacing Spring Mounting Clip

Mount each part by pushing it in the direction of the arrow shown in the corresponding illustration below.

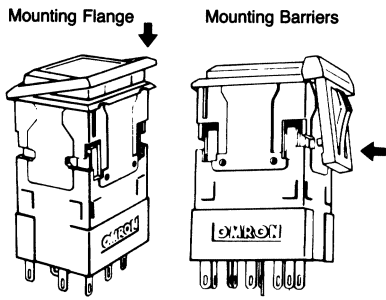

- Replacing Spring Mounting Clip

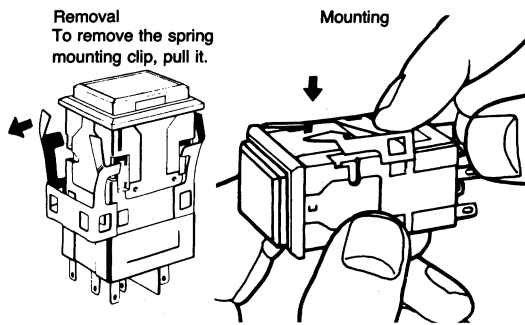

8. Mounting Seal Cover

After mounting the seal cover onto the flange of the switch unit, push the switch unit into the panel cutout.

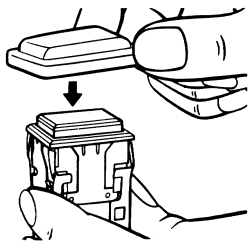

9. Fail-safe Relamping Function

- Insert the assembled display screen unit into the switch unit while pushing the center of the lens.

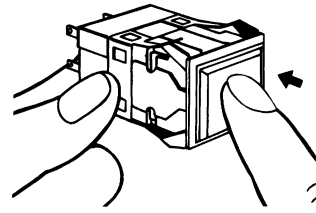

- After the display screen unit is released, the fail-safe relamping mechanism is unlocked.

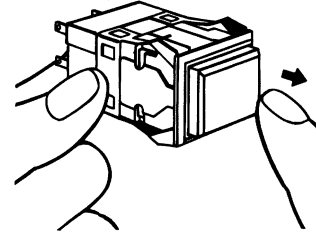

- The switch will operate normally.

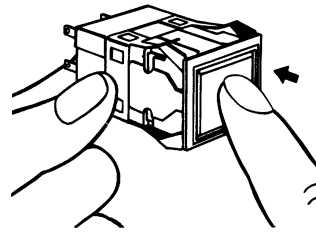



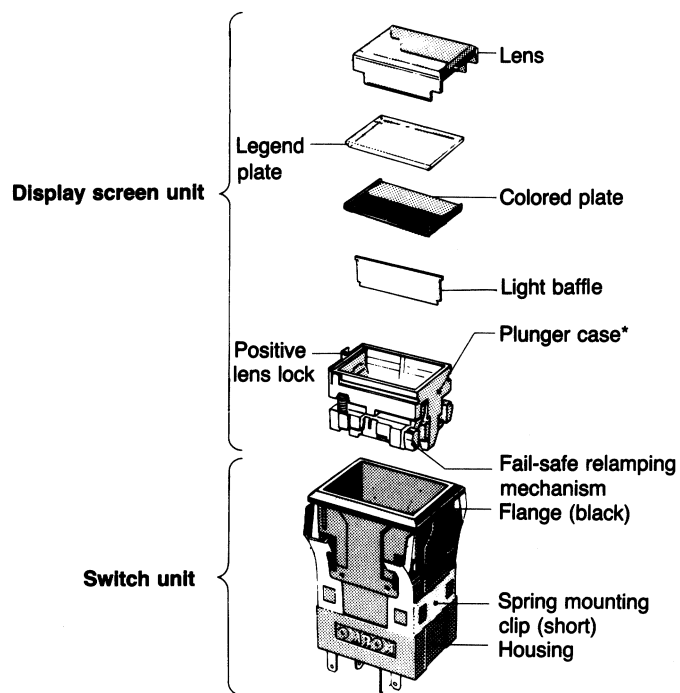



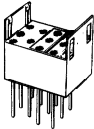

Construction



* With the LED type, an LED is incorporated in the plunger case.
With the lamp type, the lamp holder and plunger case are independent units. Insert a T-3/4 lamp in this holder.

Accessories (Order Separately)

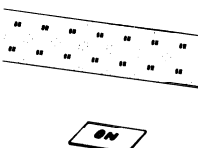
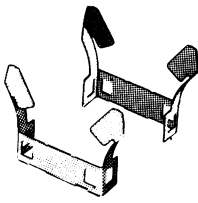
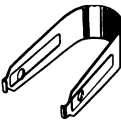
Name	Appearance	Classification		For A3PA	Remarks
Flange		Flange color	Black	A3PJ-2001	A black flange is provided to the switch unit having the suffix "-1" in its model number. To the switch unit having the suffix "-2", a light gray flange is provided.
			Light gray	A3PJ-2002	
			White	A3PJ-2003	
Socket		Wire-wrap terminal		A3PJ-4101	Cannot be used with the solid-state output type. Cannot be used with 3-pole type.
		PCB terminal		A3PJ-4102	
		Solder terminal		A3PJ-4103	
Barrier		Short-edge barrier	Black	A3PJ-4001	To prevent malfunctioning and to improve design image of the mounting panel.
			Light gray	A3PJ-4002	
		Long-edge barrier	Black	A3PJ-4004	
			Light gray	A3PJ-4005	
		Intermediate short barrier	Black	A3PJ-4007	
			Light gray	A3PJ-4008	
		Intermediate long barrier	Black	A3PJ-4010	
			Light gray	A3PJ-4011	
Switch Guard		For horizontal mounting (with OMRON logo facing down)		A3PJ-5050	Can be used by exchanging with the lens. Cannot be used with seal cover.
		For vertical mounting (with OMRON logo facing to the right)		A3PJ-5055	
Seal Cover		---		A3PJ-5060	Cannot be used with barrier and/or switch guard.
Legend Plate		Transparent legend plate		A3PJ-5202	Transparent legend plate is supplied with standard LED indicator unit.
		Milk-white legend plate		A3PJ-5201	
Character Plate (Character Film)		1 sheet (for 20 switch units)	Character printed	A3PJ-5205	Words printed are "ON", "OFF", "START", "STOP", "RESET", "COOL", and "MOTOR". Other characters can be printed by request.
			Non-printed (transparent film)	A3PJ-5207	
		1 sheet (for 1 switch unit)	Character printed	A3PJ-5206	
			Non-printed	A3PJ-5208	
Long Mounting Plate		---		A3PJ-3002	Use when vertically mounting single (with barrier) or multiple switch units (in standard mounting style and with barrier). Since a short mounting plate is attached to the switch unit, replace it with the long one.
Puller		---		A3PJ-5080	---

ALL DIMENSIONS SHOWN ARE IN MILLIMETERS.

To convert millimeters into inches, multiply by 0.03937. To convert grams into ounces, multiply by 0.03527.