

Redundancy Unit

S8VK-R

Contribute to build high reliable systems
Compact and Cost-effective solution
for Back-up applications
Easy setup for system reliability
requirement

- Redundancy operating LED for the status confirmation
- A signal output for failure detection of power supplies
- Wide range input
DC5-30V (S8VK-R10), DC10-60V (S8VK-R20)
- Wide operation temperature range: -40 to 70 °C
- Safety standards:
UL508/60950-1, CSA C22.2 No. 107.1/60950-1
EN50178, EN60950-1
- EMS: EN61000-6-2
EMI: EN61000-6-3
Lloyd's standards
- Three years warranty *

* Refer to *Period and Terms of Warranty* on page 10.

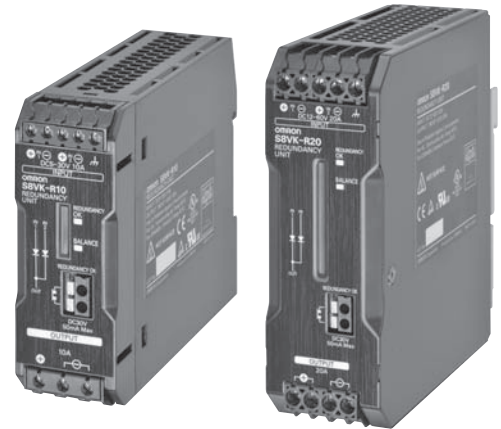

⚠ Refer to *Safety Precautions* on page 8.

Model Number Structure

Model Number Legend

S8VK-R □ □

Series name 1

1. Output current

10: 10 A

20: 20 A

Ordering Information

Note: For details on normal stock models, contact your nearest OMRON representative.

Input voltage	Output current	Model number
5 to 30 VDC	10 A	S8VK-R10
10 to 60 VDC	20 A	S8VK-R20

S8VK-R

Specifications

Ratings, Characteristics, and Functions

Item	Model number	S8VK-R10	S8VK-R20	
Input/output	Rated input voltage	5 to 30 VDC	10 to 60 VDC	
	Allowable input current	0 to 10 A	0 to 20 A	
	Rated output current	10 A	20 A	
	Boost current	12 A *	24 A *	
Voltage drop	Input to Output	0.56 V typ. 2x5 A 0.63 V typ. 1x10 A	0.67 V typ. 2x10 A 0.78 V typ. 1x20 A	
		Power losses	6.5 W 2x5 A 7.1 W 1x10 A 0.8 W 0 A	15.8 W 2x10 A 18.0 W 1x20 A 0.8 W 0 A
Additional functions	REDUNDANCY OK	Indicator	Yes (LED: Green)	
		Contact	Yes, photo switch contact 30 VDC max., 50 mA max., residual voltage when ON: 2 V max., leakage current when OFF: 0.1 mA max.	
	BALANCE	Indicator	Yes (LED: Green), Signal output: None	
Others	Ambient operating temperature		-40 to 70°C (Refer to Engineering Data)	
	Storage temperature		-40 to 85°C	
	Ambient operating humidity		0% to 95% (Storage humidity: 0% to 95%)	
	Dielectric strength		1.0 kVAC for 1 min (between all input/output terminals and \bar{I} terminal) 0.5 kVAC for 1 min (between all input/output terminals and signal output terminals) 1.0 kVAC for 1 min (between signal output terminals and \bar{I} terminal)	
	Vibration resistance		10 to 55 Hz, 0.375-mm half amplitude for 2 h each in X, Y, and Z directions	
	Shock resistance		150 m/s ² , 3 times each in $\pm X$, $\pm Y$, and $\pm Z$ directions	
	EMI	Conducted Emission	Conforms to EN 61000-6-3 EN 55011 Class B	
		Radiated Emission	Conforms to EN 61000-6-3 EN 55011 Class B	
	EMS		Conforms to EN 61000-6-2	
	Approved Standards		UL Listed: UL 508 (Listing) UL UR: UL 60950-1 (Recognition) cUL: CSA C 22.2 No.107.1 cUR: CSA C 22.2 No.60950-1 EN: EN 50178, EN 60950-1	
	Marine standards		LR standards	
	Degree of protection		IP20 by EN/IEC60529	
	Weight		195 g max.	495 g max.

Note: Ask your OMRON representative for information on the power losses and voltage drop resulting from application conditions.

* Refer to *Power Boost Function* in *Engineering Data* on page 4.

Connections

Block Diagrams

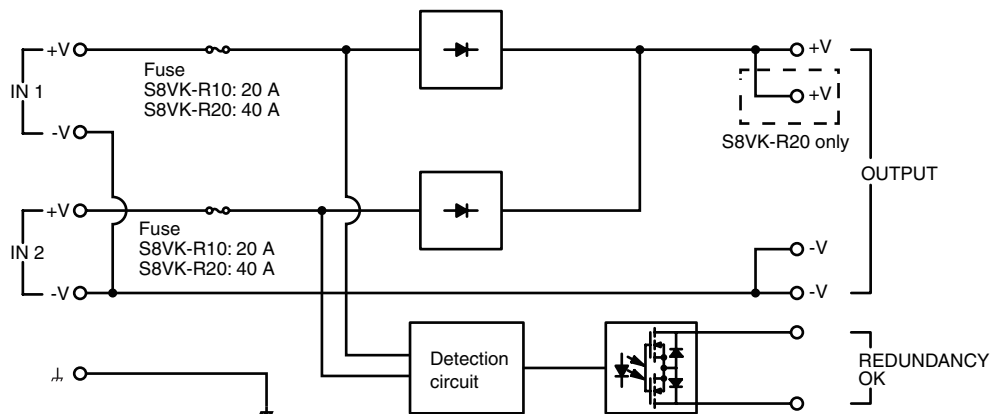

Construction and Nomenclature

Nomenclature

10 A Model
S8VK-R10

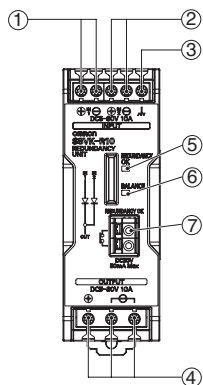

20 A Model
S8VK-R20

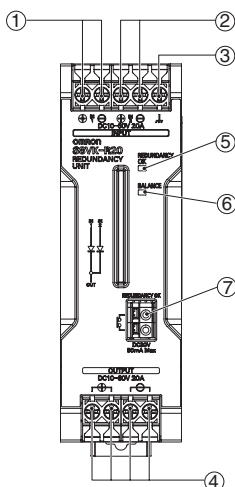

No.	Name	Function
1	Input terminal 1	Connect the input 1 lines to these terminals.
2	Input terminal 2	Connect the input 2 lines to these terminals.
3	Ground terminal	This is not an earth terminal. Functionality and safety will not be affected even when this terminal is not connected to the ground.
4	Output terminal	Connect the load lines to these terminals.
5	Status indicator: (redundancy OK: Green)	The LED lights when the voltage difference between the two power supplies is 1.2 V or less. If the voltage difference exceeds 2.4 V, the LED will turn OFF. *1
6	Status indicator: (voltage balance: Green)	The LED lights when the voltage difference between the two power supplies is 50 mV or less. *1 If you use the S8VK-G 120 W to 480 W(*2), you can assume that the output current from the two power supplies is balanced when this LED is lit. With application when the output current is balanced, you can assume that the life expectancy of the two power supplies will be longer in comparison with application when the output current is not balanced.
7	Signal output terminal: redundancy OK (photo switch)	The photo switch contact turns ON when the voltage difference between the two power supplies is 1.2 V or less. The photo switch contact turns OFF when the voltage difference between the two power supplies exceeds 2.4 V. *1

*1. Refer to *Operation Timing* for an illustration of operation.

*2. Contact your OMRON representative before you use this function for any model other than the S8VK-G.

Operation Timing

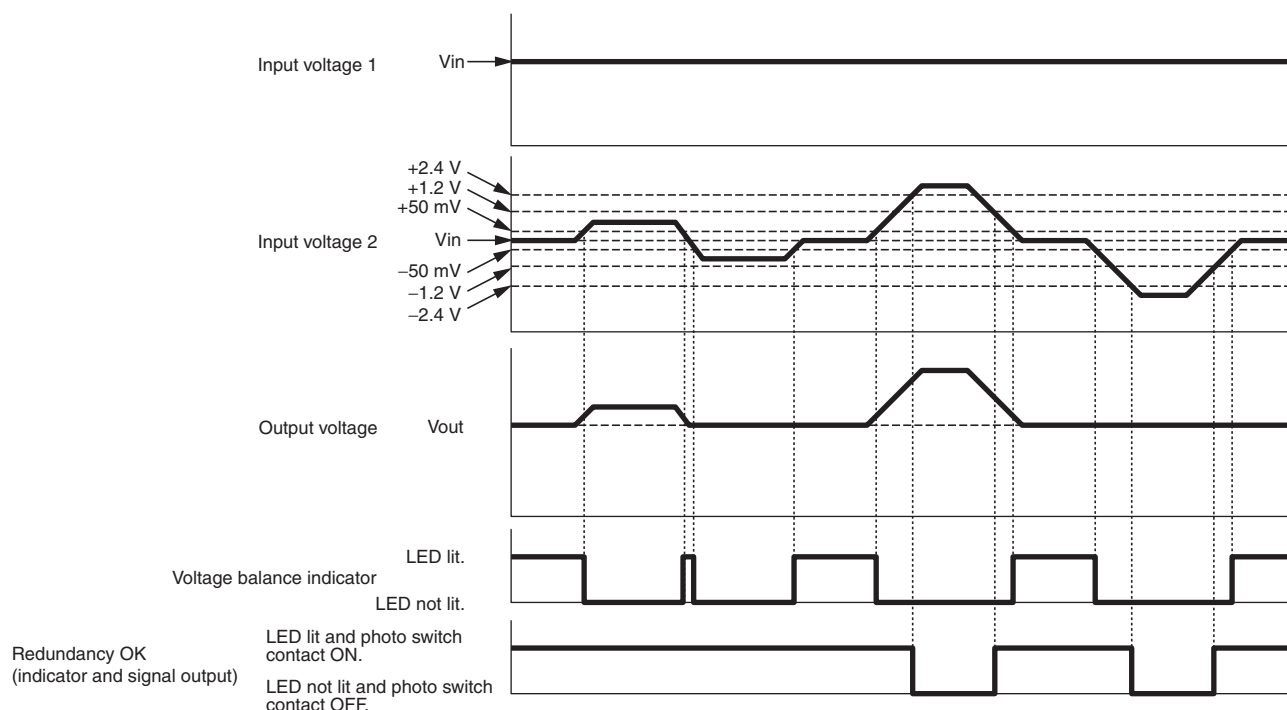

S8VK-R

Engineering Data

Derating Curve

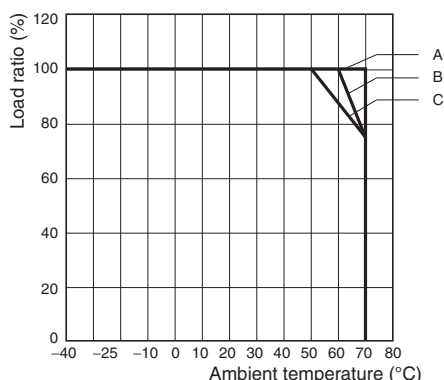

- A: Standard mounting
- B: Standard mounting (contact mounting), 60°C and over: the derating is 2.5%/°C (Contact mounting is possible only with the S8VK-G; safety standards will not apply.)
- C: Face-up mounting
50°C and over: the derating is 1.25%/°C

Mounting

(A) Standard (Vertical) mounting

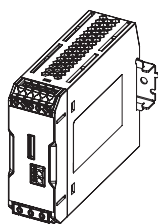

(B) Standard Mounting (Contact mounting)

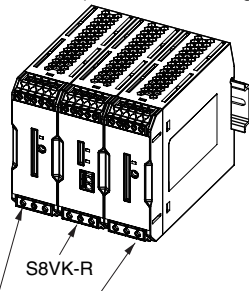

Switch Mode Power Supplies
(Must be S8VK-G.)

(C) Face-up mounting

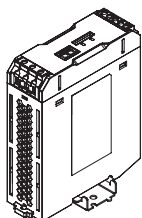

* Refer to *Mounting* on page 9.

Power Boost Function

This function is possible when used in combination with S8VK-G (All Models).

Power Boost is a function that can output the temporary repeated boost current larger than the rated current.

However, it should meet the following four Boost current conditions.

1. Time that the boost current flows: t_1
2. The maximum value of the boost current: I_p
3. The average output current: I_{ave}
4. The time ratio of the boost current flow: Duty

Note: Boost Current Conditions

- $t_1 \leq 10$ s
- $I_p \leq$ Boost current (S8VK-R10: 12 A, S8VK-R20: 24 A)
- $I_{ave} \leq$ Rated output current

$$\text{Duty} = \frac{t_1}{t_1 + t_2} \times 100 [\%] \leq 30\%$$

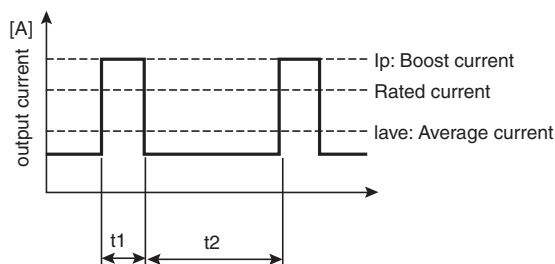

- Do not allow the boost current to continue for more than 10 seconds.
Also, do not let the duty cycle exceed the boost current conditions. These conditions may damage the Power supply.
- Ensure that the average current of one cycle of the boost current does not exceed the rated output current. This may damage the Power Supply.
- Lessen the load of the boost load current by adjusting the ambient temperature and the mounting direction.

Reference Value

	Value
Reliability (MTBF)	S8VK-R10: 720,000 hrs. S8VK-R20: 680,000 hrs.
Definition	MTBF stands for Mean Time Between Failures, which is calculated according to the probability of accidental device failures, and indicates reliability of devices. Therefore, it does not necessarily represent a life of the product.
Life expectancy	10 yrs. Min.
Definition	The life expectancy indicates average operating hours under the ambient temperature of 40°C and a load rate of 50%. Normally this is determined by the life expectancy of the built-in aluminum electrolytic capacitor.

Dimensions

(Unit: mm)

S8VK-R10

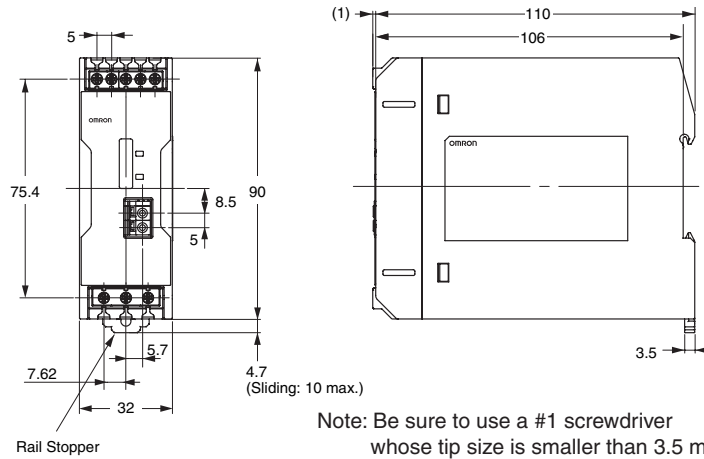

Note: Be sure to use a #1 screwdriver whose tip size is smaller than 3.5 mm diameter and longer than 4.5 mm.

S8VK-R20

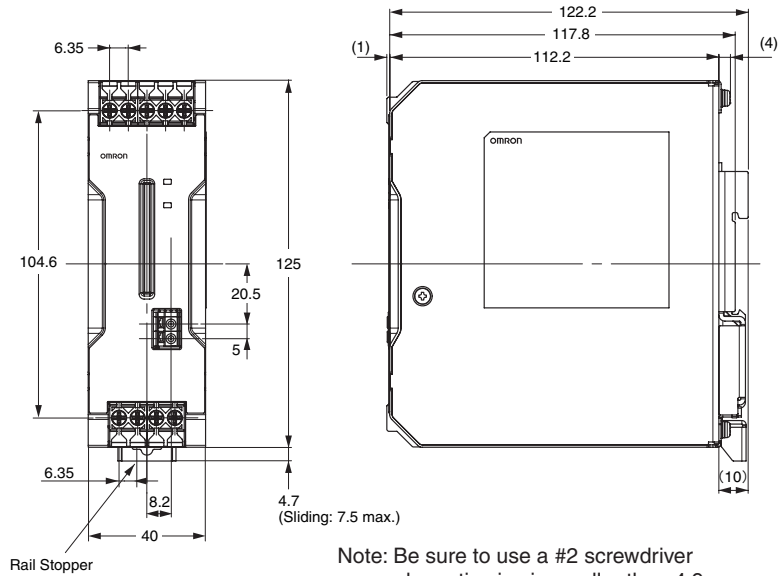

Note: Be sure to use a #2 screwdriver whose tip size is smaller than 4.9 mm diameter and longer than 10 mm.

S8VK-R

DIN Rail (Order Separately)

Note: All units are in millimeters unless otherwise indicated.

Mounting Rail (Material: Aluminum)

PFP-100N

PFP-50N

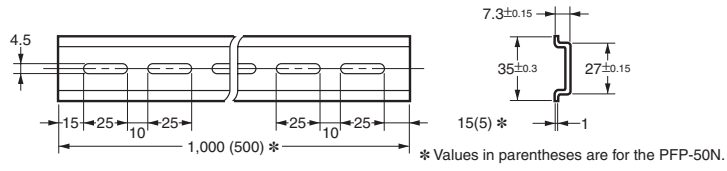
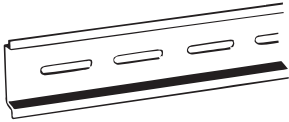

Mounting Rail (Material: Aluminum)

PFP-100N2

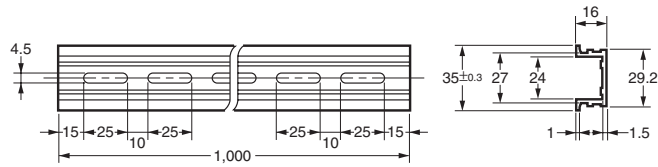

End Plate

PFP-M

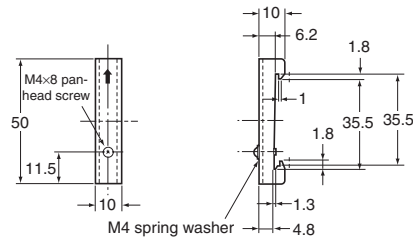

Note: If there is a possibility that the Unit will be subject to vibration or shock, use a steel DIN Rail. Otherwise, metallic filings may result from aluminum abrasion.

Mounting Brackets

Name	Model
Front-mounting bracket (for S8VK-R10)	S82Y-VS10F
Front-mounting bracket (for S8VK-R20)	S82Y-VK10F
Side-mounting bracket (for S8VK-R10)	S82Y-VS10S
Side-mounting bracket (for S8VK-R20)	S82Y-VK10S

Note: Be sure to use the accessory screws.

Mounting screw tightening torque (recommended): 4.43 to 5.31 lb-in (0.5 to 0.6 N·m)

Type	Model	Dimensions	Appearance
Front-mounting bracket (for S8VK-R10)	S82Y-VS10F		
Front-mounting bracket (for S8VK-R20)	S82Y-VK10F		
Side-mounting bracket (for S8VK-R10)	S82Y-VS10S		<p>Left-side mounting Right-side mounting</p>
Side-mounting bracket (for S8VK-R20)	S82Y-VK10S		<p>Left-side mounting * Right-side mounting *</p>



* You can mount the side of the Power Supply to a DIN Rail by removing the DIN Rail Back-mounting Bracket and then attaching a Side-mounting Bracket to the Power Supply.







Safety Precautions

Warning Indications

 CAUTION	Indicates a potentially hazardous situation which, if not avoided, may result in minor or moderate injury or in property damage.
Precautions for Safe Use	Supplementary comments on what to do or avoid doing, to use the product safely.
Precautions for Correct Use	Supplementary comments on what to do or avoid doing, to prevent failure to operate, malfunction or undesirable effect on product performance.

Meaning of Product Safety Symbols

	Used to warn of the risk of minor injury caused by high temperatures.
	Used for general mandatory action precautions for which there is no specified symbol.
	Use to indicate prohibition when there is a risk of minor injury from electrical shock or other source if the product is disassembled.

 CAUTION	
Risk of a mild burn on rare occasions. Do not touch the device unit while it is powered on or immediately after the power is turned off.	
Fire may occasionally occur. Tighten terminal screws to the specified torque of 0.5 to 0.6 N·m.	
Minor electric shock, fire, or Product failure may occasionally occur. Do not allow any pieces of metal or conductors or any clippings or cuttings resulting from installation work to enter the Product.	
Risk of product damage. Do not reverse the polarity of the device input terminals when wiring.	
Risk of internal component deterioration and damage. Do not connect an AC power supply.	
Minor electric shock, fire, or Product failure may occasionally occur. Do not disassemble, modify, or repair the Product or touch the interior of the Product.	

Precautions for Safe Use

Wiring

- Minor fire may possibly occur. Ensure that input and output terminals are wired correctly.
- Increases in the temperature of internal parts resulting from heating of wiring materials may result in deterioration or damage to parts. Use wiring materials suitable to the current being used. The following wiring materials and strip length are recommended to prevent heating and possible fires in wiring materials.

Input side: Use the following recommended wire type or the recommended wire type of the connected power supply.

Output side: Use the following recommended wire type or a wire type that has sufficient capacity for the current of the two connected power supplies.

Terminal	Model	Recommended Wire Types and Cross-sectional Areas			Wire stripping length
		AWG	Solid wire	Twisted wire	
Input	S8VK-R10	AWG14 to 12	2.5 to 4 mm ²	2.5 mm ²	8 to 10 mm
	S8VK-R20	AWG12 to 10	4 to 6 mm ²	4 mm ²	
Output	S8VK-R10	AWG14 to 12	2.5 to 4 mm ²	2.5 mm ²	
	S8VK-R20	AWG12 to 10	4 to 6 mm ²	4 mm ²	
Signal output	S8VK-R□□	AWG16	1.5 mm ²	---	

Refer to the following table for the wire diameters that are suitable for the terminal blocks.

Applicable Wire Diameters and Cross-sectional Areas for Terminal Blocks

Model	AWG	Solid wire	Twisted wire	Terminal block hole dimensions	
				W	L
S8VK-R10	AWG24 to 12	0.25 to 4 mm ²	0.25 to 2.5 mm ²	2.7	2.9
S8VK-R20	AWG22 to 10	0.35 to 6 mm ²	0.35 to 4 mm ²	2.9	2.9

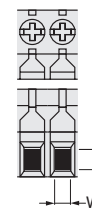

- On rare occasions there is a risk of internal element deterioration and damage if use is continued in a short-circuit or over-current state.
- Do not apply more than 75N force to the terminal block when tightening it.
- Use within a range that does not exceed the output current rating. When a load short-circuit occurs, the short-circuit current of two power supply units flows. Use output wiring that can handle the short-circuit current of two units. If the wiring does not have sufficient current capacity, connect a fuse on the output side.
Recommended fuse S8VK-R10: 15 A
S8VK-R20: 30 A
Fast-acting type
- If the current rating of the output terminal is exceeded on the S8VK-R20, always use multiple terminals simultaneously.
- Risk of damage to internal components. Do not use in a state that exceeds the rated current of the signal output.

Ambient Operating and Storage Environments

- Store the product with ambient temperature -40 to 85°C, and relative humidity 0 to 95%.
- The internal parts may occasionally be deteriorated or broken. Do not use at a temperature that exceed the operating temperature range for the mounting type.
- Use the product where the relative humidity is 0 to 95%.
- Avoid places where the product is subjected to direct sunlight.
- Avoid places where the product is subjected to penetration of liquid, foreign substance, or corrosive gas.
- Avoid places subject to shock or vibration. A device such as a contact breaker may be a vibration source.
Set the Redundancy Unit as far as possible from possible sources of shock or vibration.
- If the Redundancy Unit is used in an area with excessive electronic noise or surge, be sure to separate the Redundancy Unit as far as possible from the noise sources.

Precautions for Correct Use

Mounting

- The long-term reliability of the S8VK-R can be increased by installing it properly and sufficiently considering heat dissipation.
- Install the S8VK-R so that the air flow circulates around it, because the S8VK-R is designed to radiate heat by means of natural air circulation.
- Can be used in a contact mounting with the S8VK-G (not covered by safety certification). Two S8VK-G units cannot be mounted together in a contact mounting.

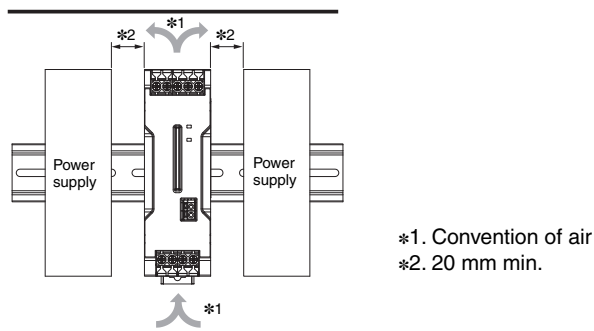

DIN Rail Mounting

To mount the Redundancy Unit to a DIN Rail, pull down the rail stopper until you hear it click, hook portion (A) of the Redundancy Unit onto the DIN Rail, and press the Redundancy Unit in direction (B), then, push up the rail stopper to lock the Redundancy Unit in place.

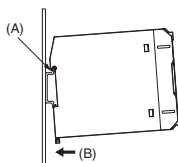

To remove the Redundancy Unit, pull down portion (C) with a flat-blade screwdriver and pull off the Redundancy Unit.

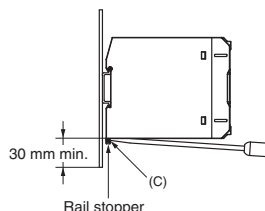

Input Power Supply Selection

- This product contains an internal fuse. If a power supply other than the recommended power supplies is used, the fuse may blow, depending on the state of the load. Connect only the recommended power supplies to the Redundancy Unit.
Recommended Power Supplies
 - S8VK Series
 - S8VS Series
 - S8JX Series
- If you are building a redundant system, never use in a state that exceeds the rated current of the power supply. If one of the power supplies goes down, there is a risk that the voltage on the load side cannot be attained.
- Use the same model for the power supplies that are connected.
- Do not use in applications where load rush current or overload may frequently occur. Slight risk of deterioration and damage due to internal loss.

Combinations

Combinations with the S8VK-G

Model number	For parallel operation	For backup operation
S8VK-G01505	S8VK-R10	S8VK-R10
S8VK-G01512		
S8VK-G01524		
S8VK-G03005		
S8VK-G03012		
S8VK-G03024		
S8VK-G06012		
S8VK-G06024		
S8VK-G12024		
S8VK-G24024		
S8VK-G24048		
S8VK-G48048		
S8VK-G48048	-	-

Combinations with the S8VK-T

Model number	For parallel operation	For backup operation
S8VK-T12024	S8VK-R10	S8VK-R10
S8VK-T24024	S8VK-R20	S8VK-R10
S8VK-T48024		S8VK-R20
S8VK-T96024	-	-

Dielectric Strength Test

- The S8VK-R is designed to withstand a voltage test of 1 kV AC for one minute between all input/output terminals and the ground terminal and between signal output terminals and the ground terminal, and 0.5 kV AC for one minute between all input/output terminals and the signal output terminal.

- Note:**
1. The S8VK-R may possibly be damaged from the impulse voltage if a testing device switch is used to abruptly apply or shut off 1 kV AC, 0.5 kV AC. Increase the applied voltage gradually using the voltage adjustment on the testing device.
 2. When testing, always short-circuit all terminals to prevent damage to the output terminal.

Signal output

- Photo switch output
30 VDC max. (LVLC), 50 mA max., residual voltage when ON: 2 V max., leakage current when OFF: 0.1 mA max.
- Wire the signal output circuits correctly.
- The signal output circuits do not contain current-limiting circuits. Do not allow the output current to exceed 50 mA.
- After you complete the wiring, confirm that operation is correct.

Status display LEDs

- The redundancy OK LED and signal output provide criteria for checking the redundancy status from the electrical potential difference between the two power supplies. It is not intended as a conclusive means of determining the redundancy status. You must periodically check the output voltage from the two power supplies.
- The voltage balance display is not intended as a conclusive means of determining the current balance. The degree of balance varies by the model. If you require operation with balanced current, use the same thickness and length of wiring from each power supply to the S8VK-R and check the output current from each power supply.
- If you monitor the voltage balance display during voltage adjustment, adjust the voltage of only one of the power supplies. If you must adjust the voltages of both power supplies, be sure to check the output voltage before use.
- Measure the voltage output from the S8VK-R with the primary side voltage applied to only one of the connected power supplies and adjust the voltage output from the power supply to the specified output voltage.

S8VK-R

- Then apply the primary side voltage to the other power supply and adjust the voltage output from the power supply that was turned ON last until the voltage balance indicator lights.
- This procedure will allow you to adjust the difference in the output voltage from the two power supplies to within 50 mV of the specified output voltage.
- The operation of the signal output and status indicator LEDs may sometimes be unstable. When using in environments where the temperature is less than -25°C , always adjust the 5-V power supply to 5.3 V or higher.

Connections

It is possible to connect S8VK-R like below.

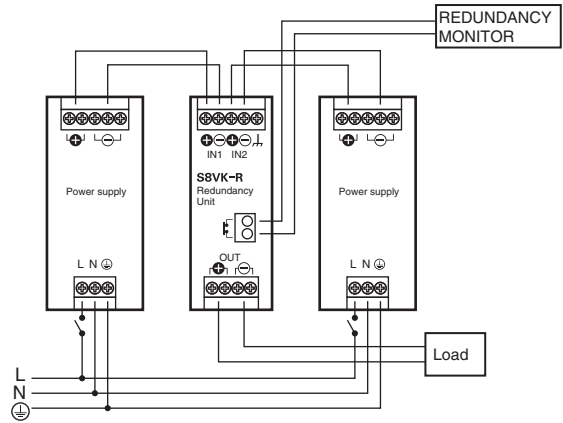

Period and Terms of Warranty

Warranty Period

The product warranty is valid for a period of three years from the date of shipment from the factory.

Terms of Warranty

The warranty is valid only for the following operating conditions.

1. Operation within the derating curve
2. Mounting method: Standard mounting

If the product fails for reasons attributable to OMRON within the above warranty period, OMRON will repair or replace the faulty part of the product at the place of purchase or the place where the product delivered without charge.

This warranty does not cover the following types of failures.

- (1) Failures that result from handling or operation of the product under conditions or in environments that are not given in this document and not given in any other specifications exchanged between OMRON and the customer
 - (2) Failures that originate in causes other than the delivered product itself
 - (3) Failures caused by disassembly, modification, or repair of the product by anyone other than OMRON
 - (4) Failures caused by applications or uses for which the product was not originally intended
 - (5) Failures caused by factors that could not be anticipated with the scientific or technical knowledge available when the product was shipped
 - (6) Failures caused by other causes for which OMRON is not responsible, such as natural disasters and other acts of God
- This warranty is limited to the individual product that was delivered and does not cover any secondary, subsequent, or related damages.

Recommended Replacement Periods and Periodic Replacement for Preventive Maintenance

The recommended replacement period for preventive maintenance is greatly influenced by the application environment of the product. As a guideline, the recommended replacement period is 20 years.*

To prevent failures or accidents that can be caused by using a product beyond its service life, we recommend that you replace the product as early as possible within the recommended replacement period.

However, bear in mind that the recommended replacement period is for reference only and does not guarantee the life of the product.

* The recommended replacement period applies under the following conditions: rated input voltage, ambient temperature of 40°C max., and the standard mounting method.

Terms and Conditions Agreement

Read and understand this catalog.

Please read and understand this catalog before purchasing the products. Please consult your OMRON representative if you have any questions or comments.

Warranties.

- (a) Exclusive Warranty. Omron's exclusive warranty is that the Products will be free from defects in materials and workmanship for a period of twelve months from the date of sale by Omron (or such other period expressed in writing by Omron). Omron disclaims all other warranties, express or implied.
- (b) Limitations. OMRON MAKES NO WARRANTY OR REPRESENTATION, EXPRESS OR IMPLIED, ABOUT NON-INFRINGEMENT, MERCHANTABILITY OR FITNESS FOR A PARTICULAR PURPOSE OF THE PRODUCTS. BUYER ACKNOWLEDGES THAT IT ALONE HAS DETERMINED THAT THE PRODUCTS WILL SUITABLY MEET THE REQUIREMENTS OF THEIR INTENDED USE.

Omron further disclaims all warranties and responsibility of any type for claims or expenses based on infringement by the Products or otherwise of any intellectual property right. (c) Buyer Remedy. Omron's sole obligation hereunder shall be, at Omron's election, to (i) replace (in the form originally shipped with Buyer responsible for labor charges for removal or replacement thereof) the non-complying Product, (ii) repair the non-complying Product, or (iii) repay or credit Buyer an amount equal to the purchase price of the non-complying Product; provided that in no event shall Omron be responsible for warranty, repair, indemnity or any other claims or expenses regarding the Products unless Omron's analysis confirms that the Products were properly handled, stored, installed and maintained and not subject to contamination, abuse, misuse or inappropriate modification. Return of any Products by Buyer must be approved in writing by Omron before shipment. Omron Companies shall not be liable for the suitability or unsuitability or the results from the use of Products in combination with any electrical or electronic components, circuits, system assemblies or any other materials or substances or environments. Any advice, recommendations or information given orally or in writing, are not to be construed as an amendment or addition to the above warranty.

See <http://www.omron.com/global/> or contact your Omron representative for published information.

Limitation on Liability; Etc.

OMRON COMPANIES SHALL NOT BE LIABLE FOR SPECIAL, INDIRECT, INCIDENTAL, OR CONSEQUENTIAL DAMAGES, LOSS OF PROFITS OR PRODUCTION OR COMMERCIAL LOSS IN ANY WAY CONNECTED WITH THE PRODUCTS, WHETHER SUCH CLAIM IS BASED IN CONTRACT, WARRANTY, NEGLIGENCE OR STRICT LIABILITY.

Further, in no event shall liability of Omron Companies exceed the individual price of the Product on which liability is asserted.

Suitability of Use.

Omron Companies shall not be responsible for conformity with any standards, codes or regulations which apply to the combination of the Product in the Buyer's application or use of the Product. At Buyer's request, Omron will provide applicable third party certification documents identifying ratings and limitations of use which apply to the Product. This information by itself is not sufficient for a complete determination of the suitability of the Product in combination with the end product, machine, system, or other application or use. Buyer shall be solely responsible for determining appropriateness of the particular Product with respect to Buyer's application, product or system. Buyer shall take application responsibility in all cases.

NEVER USE THE PRODUCT FOR AN APPLICATION INVOLVING SERIOUS RISK TO LIFE OR PROPERTY OR IN LARGE QUANTITIES WITHOUT ENSURING THAT THE SYSTEM AS A WHOLE HAS BEEN DESIGNED TO ADDRESS THE RISKS, AND THAT THE OMRON PRODUCT(S) IS PROPERLY RATED AND INSTALLED FOR THE INTENDED USE WITHIN THE OVERALL EQUIPMENT OR SYSTEM.

Programmable Products.

Omron Companies shall not be responsible for the user's programming of a programmable Product, or any consequence thereof.

Performance Data.

Data presented in Omron Company websites, catalogs and other materials is provided as a guide for the user in determining suitability and does not constitute a warranty. It may represent the result of Omron's test conditions, and the user must correlate it to actual application requirements. Actual performance is subject to the Omron's Warranty and Limitations of Liability.

Change in Specifications.

Product specifications and accessories may be changed at any time based on improvements and other reasons. It is our practice to change part numbers when published ratings or features are changed, or when significant construction changes are made. However, some specifications of the Product may be changed without any notice. When in doubt, special part numbers may be assigned to fix or establish key specifications for your application. Please consult with your Omron's representative at any time to confirm actual specifications of purchased Product.

Errors and Omissions.

Information presented by Omron Companies has been checked and is believed to be accurate; however, no responsibility is assumed for clerical, typographical or proofreading errors or omissions.

OMRON Corporation Industrial Automation Company
Tokyo, JAPAN

Contact: www.ia.omron.com

Regional Headquarters

OMRON EUROPE B.V.

Wegalaan 67-69-2132 JD Hoofddorp
The Netherlands
Tel: (31)2356-81-300/Fax: (31)2356-81-388

OMRON ELECTRONICS LLC

One Commerce Drive Schaumburg,
IL 60173-5302 U.S.A.
Tel: (1) 847-843-7900/Fax: (1) 847-843-7787

OMRON ASIA PACIFIC PTE. LTD.

No. 438A Alexandra Road # 05-05/08 (Lobby 2),
Alexandra Technopark,
Singapore 119967
Tel: (65) 6835-3011/Fax: (65) 6835-2711

OMRON (CHINA) CO., LTD.

Room 2211, Bank of China Tower,
200 Yin Cheng Zhong Road,
PuDong New Area, Shanghai, 200120, China
Tel: (86) 21-5037-2222/Fax: (86) 21-5037-2200

Authorized Distributor:

© OMRON Corporation 2013-2014. All Rights Reserved.
In the interest of product improvement,
specifications are subject to change without notice.

CSM_3_2_1015
Cat. No. T059-E1-02

0614 (0613)