

## Accessories

### Back Connecting Socket P6B-04P

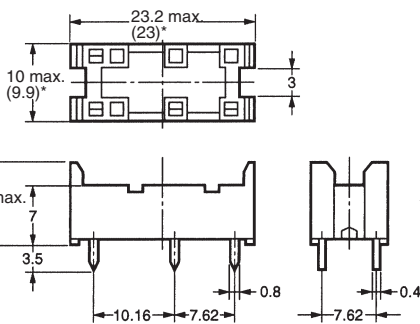

#### Mounting Holes (Bottom View)

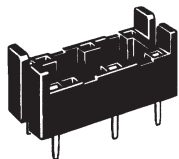
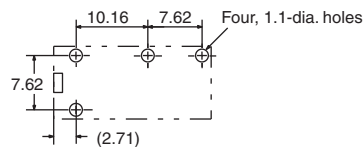

\*Average value

### P6B-06P

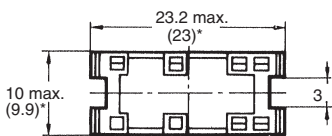
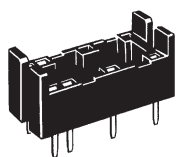

#### Mounting Holes (Bottom View)

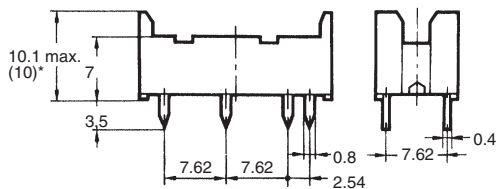
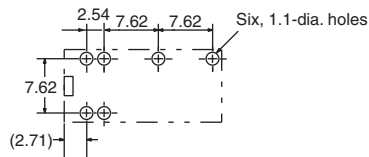

\*Average value

### P6B-26P

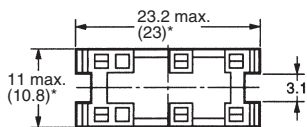
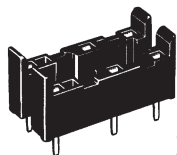

#### Mounting Holes (Bottom View)

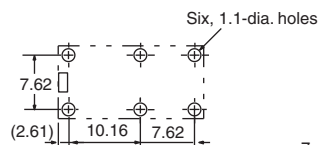

#### Mounting Height of Relay with Connecting Socket

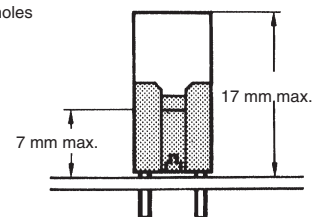

**Note:** Rated current of socket is 5 A max.

**Note:** Height of G6B-1174P-US is 19.5 mm max.

\*Average value

### Removal Tool P6B-Y1

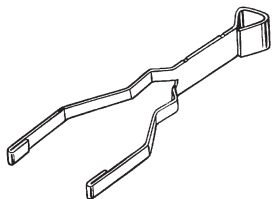

### Hold-down Clips P6B-C2

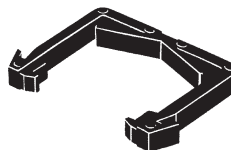

**Note:** P6B-C2 Hold-down Clips cannot be used for G6B-1174P-US.