

NX-series I/O System

Unique I/O increases application quality and range



- Standardization of control system
- Quality improvement by synchronizing data collection
- Flexible system configuration

Unique I/O increases application quality and

The NX I/O connects sensors and actuators on production lines to optimize applications

Application example



Corresponding to our shared **Value Design for Panel** concept for the specifications of products

IoT

IO-Link makes communication down to the sensor level visible

Applicable units:
NX-ECC203
NX-ILM400

Traceability

Easy and quick set-up for traceability using RFID

Applicable units:
NX-V680C1
NX-V680C2

Measuring

PLC systems can measure analog signals at high speeds for inspections

Applicable units:
NX-HAD401

Weighing

High-accuracy weighing using load cells

Applicable units:
NX-RS1201



Communications coupler

- EtherCAT®
- EtherNet/IP™

IO-Link master

- Up to 4 IO-Link devices with one master

Serial communications

- RS-232C or RS-422A/485 interface

New RFID

- Direct connection to V680 amplifiers and antennas
- 1 or 2 channels

Digital I/O

- 4, 8, 16, or 32 channels per input unit
- 2, 4, 8, 16, or 32 channels per output unit (8 channels per relay output unit)
- 16 channels per mixed I/O unit
- Standard, high-speed, and time-stamp models
- Units with Push-In Plus/MIL/Fujitsu/M3 Screw connector

Analog I/O

- +/-10V voltage and 4-20 mA current signals
- 2, 4 or 8 channels per input unit
- 2 or 4 channels per output unit
- Standard and high-performance models
- Single-ended input and differential input models

New High-speed analog inputs

- 4 channels per input unit
- Differential input
- Sampling as fast as every 5 μs

Load cell inputs

- One load cell with one unit
- Fastest conversion cycle of 125 μs

range

Servo press

High-speed, high-precision press fit using load cells

Applicable units:
NX-RS1201
NX-SIH200
NX-SOD400

Safety control

Simplify safety control systems

Applicable units:
NX-SL3300
NX-SIH400
NX-SOH200

Temperature control

Simplify temperature control systems using temperature sensors

Applicable units:
NX-TS3101
NX-HB3101
NX-TC3405

Motion

Simplify position control systems using pulse-train input type motors

Applicable units:
NX-ECS212
NX-PG0342-5

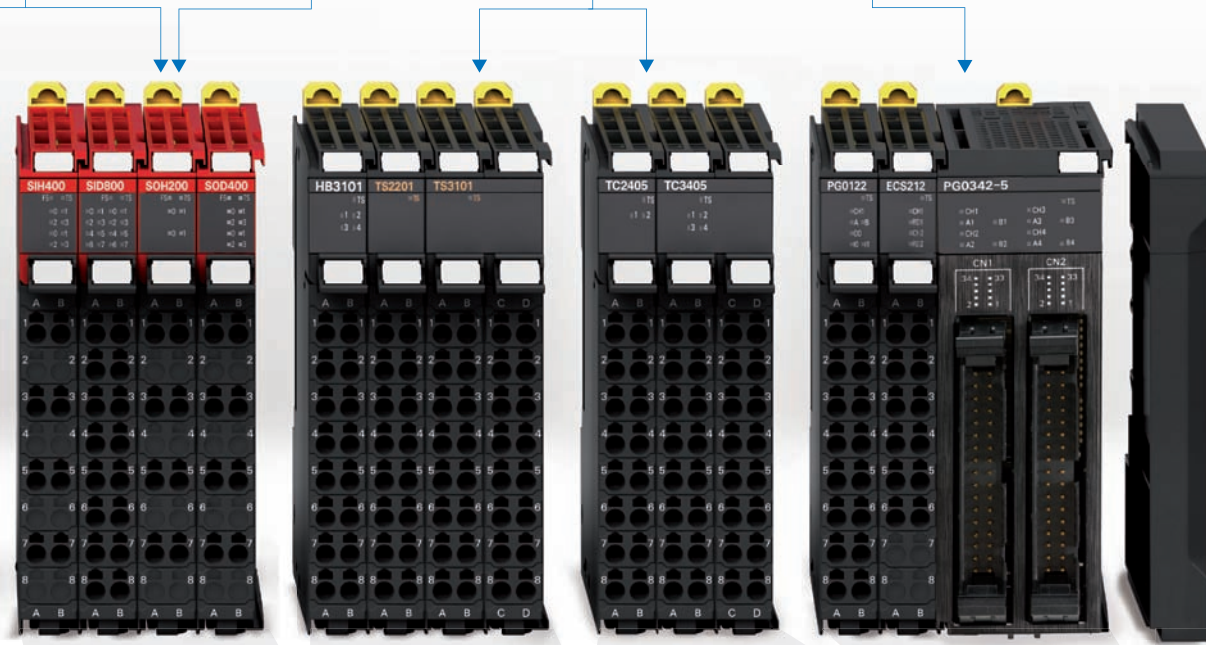

Safety I/O

- 4 or 8 safety input points per unit
- 2 or 4 safety output points per unit
- Free allocation of the safety I/O units on the internal high speed bus

Safety CPU

- EN ISO13849-1 (PLe/Safety Category 4), IEC 61508 (SIL3) certified
- Controls up to 128 safety I/O units

Temperature inputs

- Thermocouple or RTD inputs, 2 or 4 per unit
- Conversion time of 10 ms, 60 ms or 250 ms

Heater burnout detection

- 4 CT sensor inputs and 4 trigger outputs to drive SSRs

New

Temperature control

- 2 or 4 multi-input (thermocouple and resistance thermometer) channels per unit
- Conversion time of 50 ms
- Voltage output (for driving SSR) or linear current output
- 1 CT input per channel

Position interface

- Incremental and absolute encoder support
- Pulse output unit (line driver output model)

End cover

Systemac is a trademark or registered trademark of OMRON Corporation in Japan and other countries for OMRON factory automation products. EtherCAT® and Safety over EtherCAT® are the registered trademarks and patented technology, licensed by Beckhoff Automation GmbH, Germany. EtherNet/IP™ is the trademark of ODVA. SQL Server and Visual Basic are either registered trademarks or trademarks of Microsoft Corporation in the United States and/or other countries. Other company names and product names in this document are the trademarks or registered trademarks of their respective companies. The product photographs and figures that are used in this catalog may vary somewhat from the actual products. Some images are used under license from Shutterstock.com. Microsoft product screen shot(s) reprinted with permission from Microsoft Corporation.

Simplicity for advanced control

A fully integrated platform

The NX I/O is used to integrate sequence, motion, analog, vision, and safety control, previously done by PLC and dedicated controllers, and visualization of previously invisible sensor data within the Sysmac automation platform.

Sequence control

Multi-tasking and fully compliant with IEC 61131-3 standard programming and PLCopen® Function Blocks.

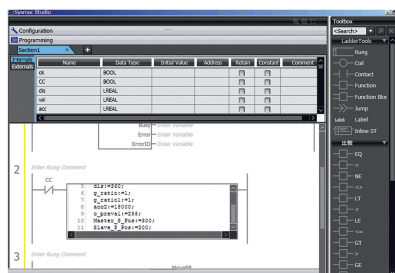

Motion control

PLCopen® Function Blocks for the motion control library are available to implement advanced motion control.

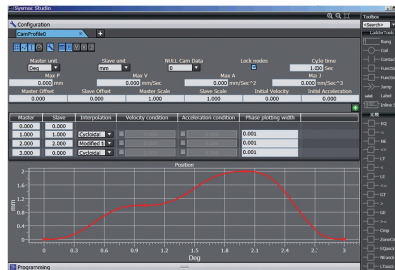

Analog control

The Sysmac Library* and instructions make temperature, weighing, and load control easier.



Weighing Control Library
Servo Press Library



*The Sysmac Library is a collection of software functional components that can be used in programs for the NJ/NX/NY Controllers. Sample programs and HMI templates are also available. Download from Omron website and install to use in the Automation Software Sysmac Studio. http://www.ia.omron.com/sysmac_library/



EtherNet/IP™

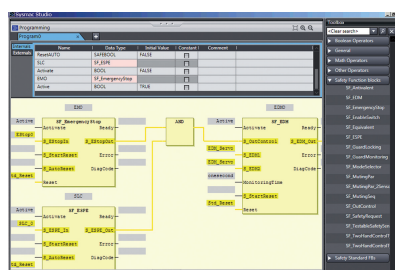

Safety control

Conforms with PLCopen® Function Blocks for Safety.



Feature of Sysmac

One Control through
 One Software and
 One Network
 simplifies control system configuration

Interfaces for sequence, motion, safety, and analog control and communications required for machines

Visualized sensor data

IO-Link makes communication down to the sensor level visible



EtherCAT

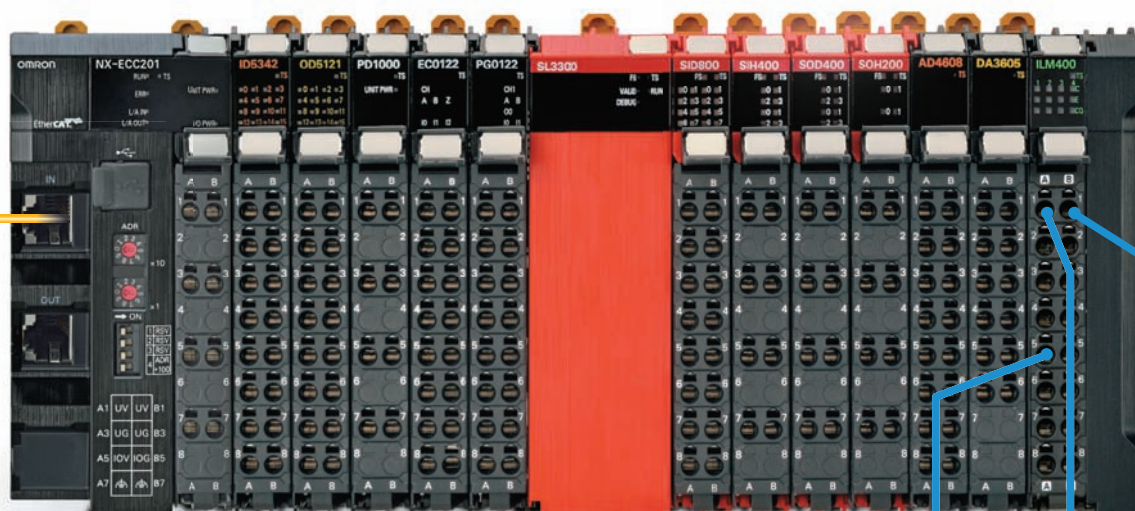

Connecting directly to most sensors, actuators, and safety components

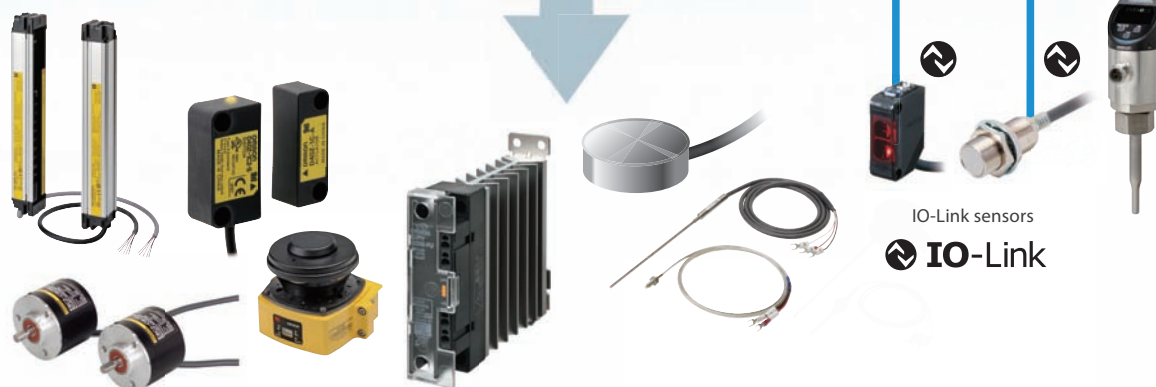

IO-Link sensors
IO-Link

Note: Functionality provided by the EtherCAT coupler unit

Synchronized control for high-speed performance

Production data collection synchronized at high speed

Based on an internal high-speed bus running in synchronization with the EtherCAT network and CPU cycle, the NX I/O can be controlled and used for position, analog, and digital data collection with microsecond accuracy and with nanosecond resolution.

Feature

High-speed I/O units accurately synchronized with the CPU cycle*1

- Digital I/O: High-speed and time-stamp models (NsynX)
- Analog I/O: 10 μ s conversion time per channel and 1:30000 resolution
- Load cell inputs: 125 μ s conversion time per channel and 24-bit resolution

*1. Fastest cycle time: NX7=125 μ s, NJ5=500 μ s

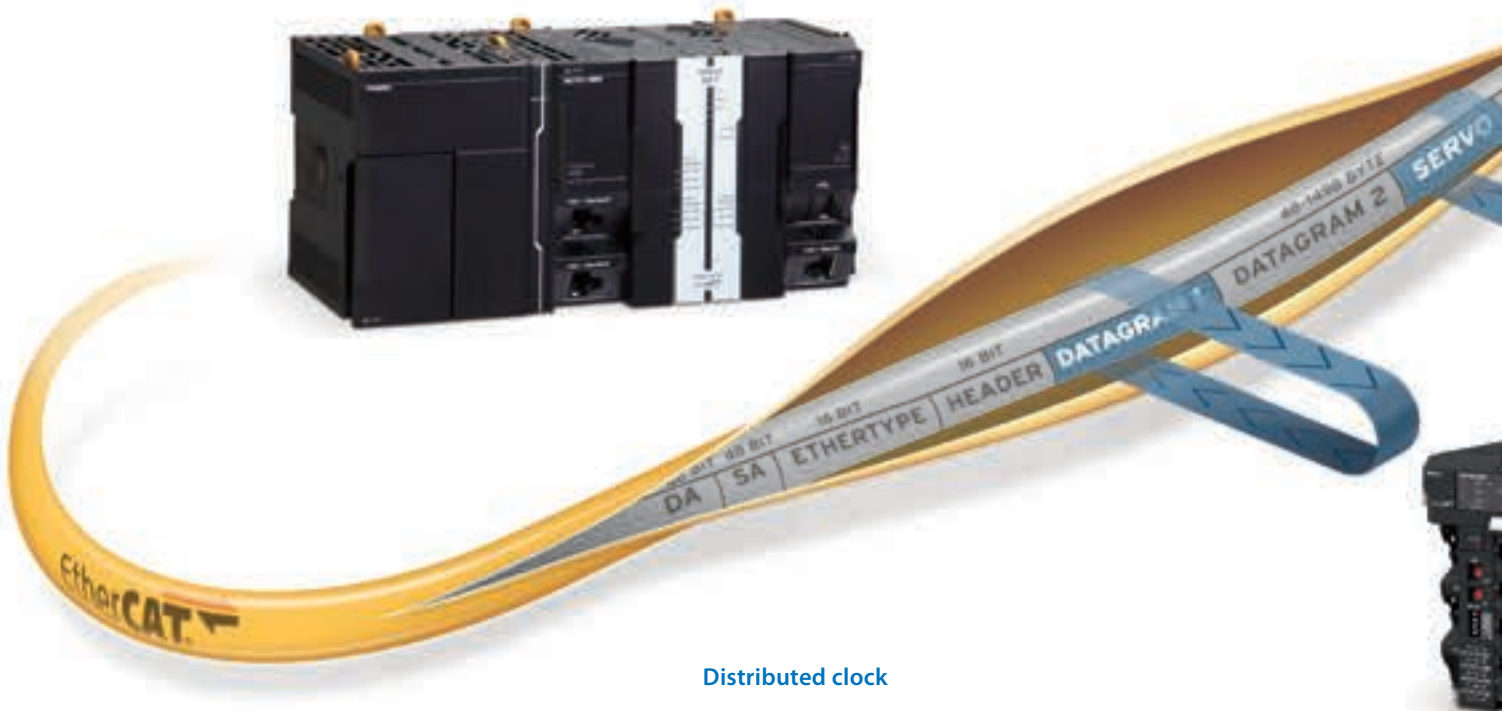

Distributed clock

The EtherCAT node slave measures the time difference between incoming and returning frame - Time-Stamp function. With this Time-Stamp function the master can determine the propagation delay offset to the individual slave accurately. This mechanism ensures accurate synchronization between devices with less than 1 μ s jitter.

NsynX technology

- The NsynX technology is provided by the internal high-speed bus synchronized with the EtherCAT network. This technology is designed for machine control and includes:
- I/O units with distributed clock
- High-speed I/O units synchronized with the EtherCAT cycle
- I/O units with Time-Stamp function

Time Stamp sequence example

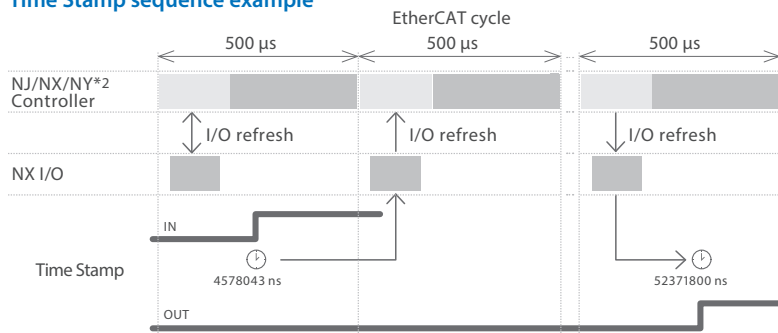

Accurate control of input events and perfect control of output with nanosecond resolution

*2. Industrial PC Platform NY-series IPC Machine Controller only.

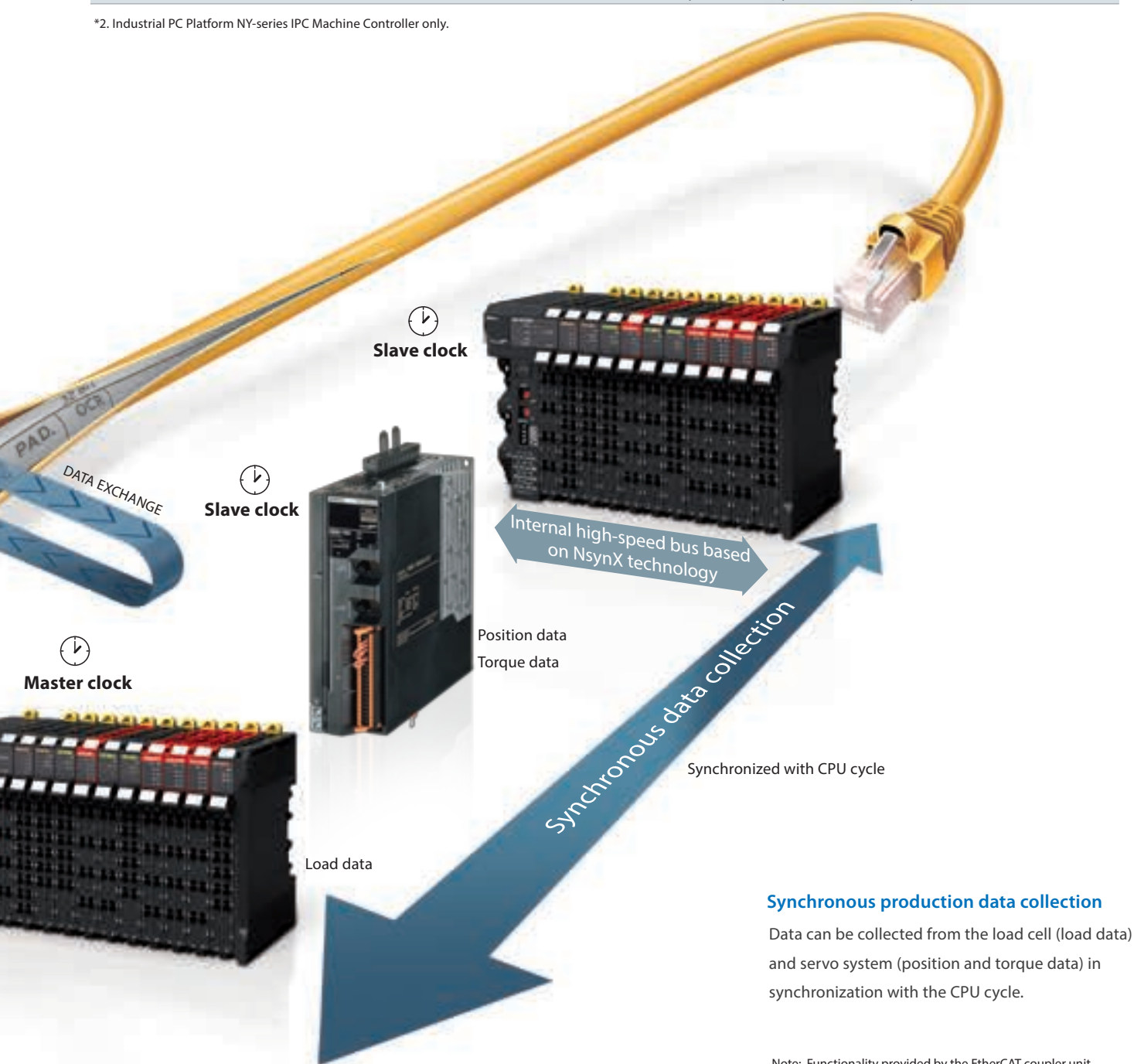

Synchronous production data collection

Data can be collected from the load cell (load data) and servo system (position and torque data) in synchronization with the CPU cycle.

Note: Functionality provided by the EtherCAT coupler unit

Simplify system configurations

The choice is yours

The modern control system demands increasing levels of flexibility.

The NX I/O enables connection with various controllers through the global standard network, which expands system configuration possibilities.

Modular remote I/O systems offer flexibility in I/O configuration and a wide choice of signal types and performance levels so that every I/O station can be assembled with just the right combination without changing the control architecture.

EtherCAT®

EtherCAT specification is governed by the EtherCAT Technology Group (ETG). EtherCAT is suitable for motion control and other applications that require high speed and high precision because of no need of handshaking and high bandwidth utilization.



NJ/NX/NY Series or EtherCAT master from other vendors



EtherNet/IP™

EtherNet/IP specification is governed by the Open DeviceNet Vendors Association (ODVA). Based on standardized Ethernet protocols (TCP/IP, UDP/IP), EtherNet/IP devices can be mixed with standard Ethernet devices.



CJ Series or PLC from other vendors



Feature

Wide choice: More than 100 types of I/O unit, from 2 to 32 points in one unit



Types of NX I/O Units

- Digital Input/Output Units
- Analog Input/Output Units
- Temperature Input Units
- Encoder/Positioning Units
- System Units
- Serial communication Units



Quick connections

- Detachable screwless terminal block for easy commissioning and maintenance
- Push-In Plus connections speed up installation
- MIL/Fujitsu connectors for high-density I/O



Safety integrated

The NX Safety CPU Unit and Safety I/O Units can be mixed with standard I/O units to create a complete modular safety control system

- Note: 1. Communications coupler units vary depending on the connected network.
 2. Connectable units vary depending on the communications coupler unit.
 3. The number of connectable nodes varies depending on the master.

Downsize machines and control panels

Reduce wiring time and save space

Push-In Plus connections reduce the work and time required for wiring. Modular design saves space. Also designed for installation in any orientation, the NX I/O can be freely allocated in machines.

Up to 63 units per communication coupler



Feature

Compact design: Up to 16 digital signals in 12 mm width

12mm



Corresponding to our shared Value Design for Panel concept for the specifications of products



Greatly reduce wiring work with Push-In Plus terminal blocks

Push-In Plus terminal blocks make wiring work easy - just insert wires.

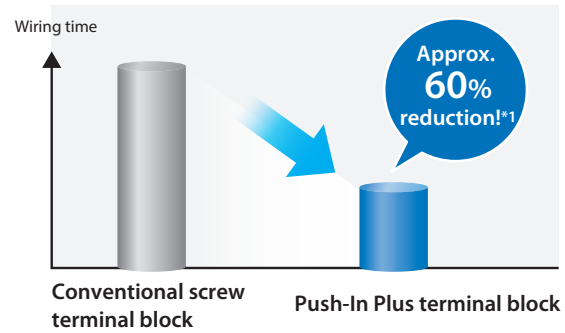

*1. Information for Push-In Plus and screw terminal blocks is based on Omron's actual measurement data.

Save space in control panels

V and G terminals are provided for each input signal (NX-PC0030). No relay terminal block is required, which saves space in control panels.

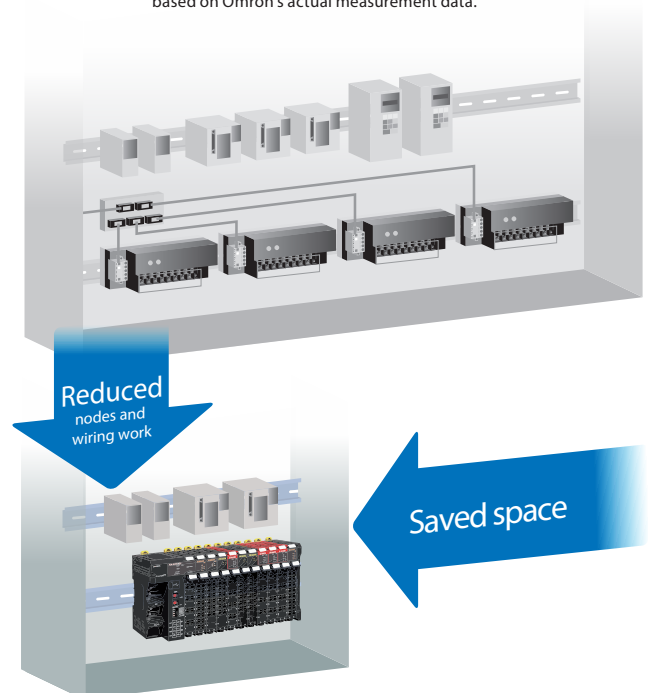
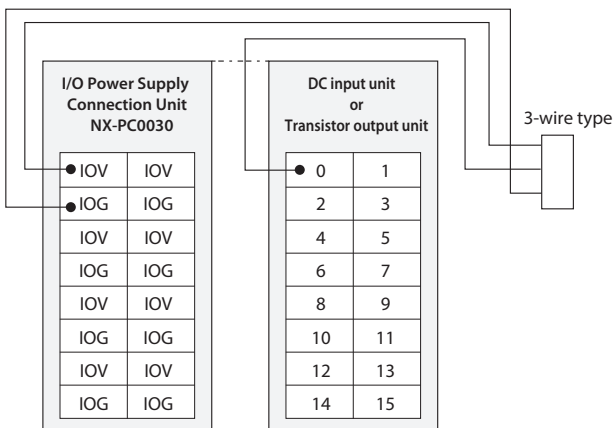

Flexible connectivity expands system configuration possibilities

One I/O system for various controllers

While different machines may require different levels of controller performance, the NX I/O is the only remote I/O system you will need. This will unify wiring and installation techniques, and simplify spare parts stock.

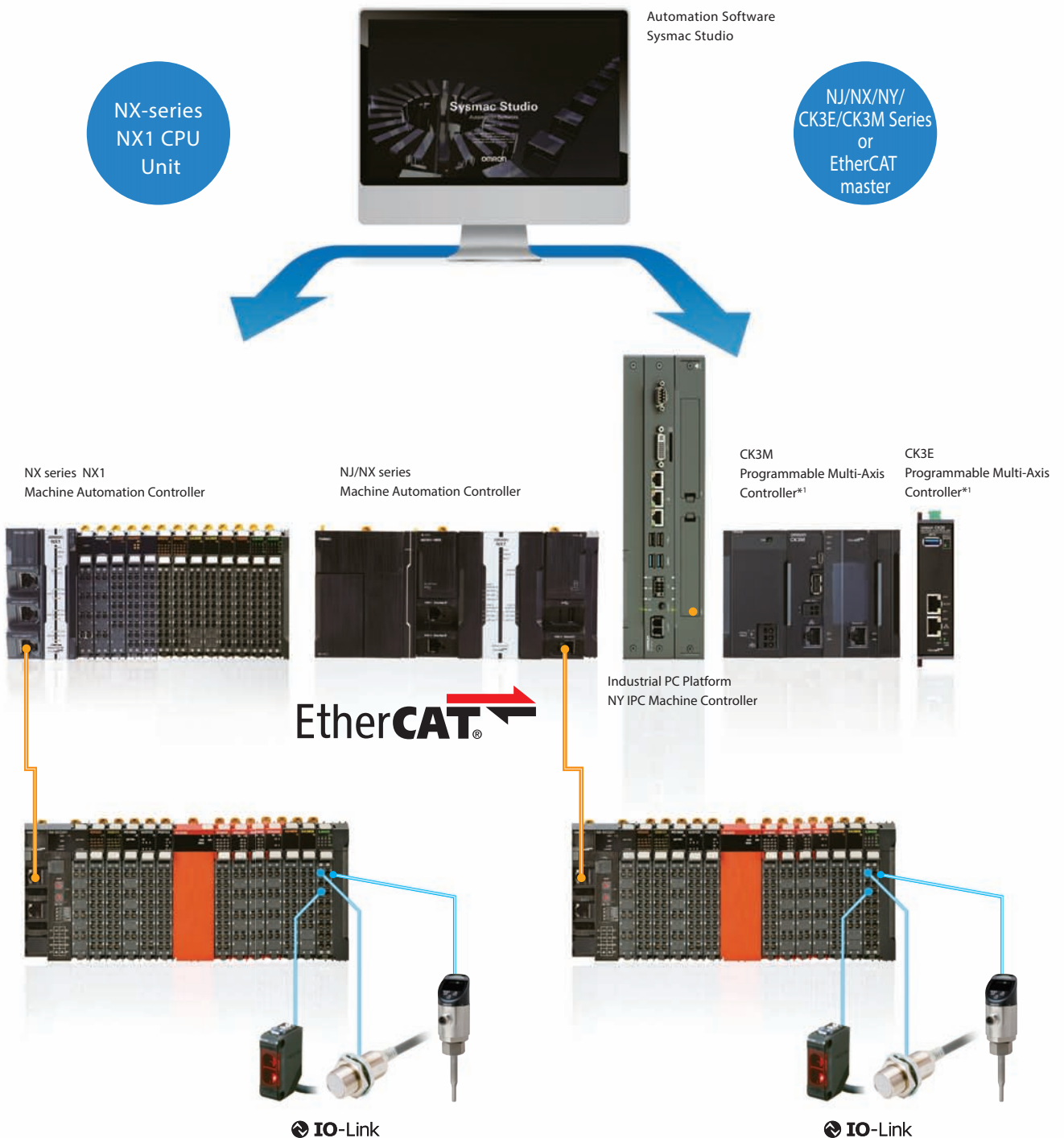

*1. Dedicated software is required to use the CK3M and CK3E Series.

Features

- Multivendor compatibility
The NX I/O can be connected with PLC from other vendors as well as Omron PLC
- Start a small-scale IO-Link
IO-Link and other unique I/O systems can be easily integrated into existing machine configurations

Easy configuration with NX-IO Configurator

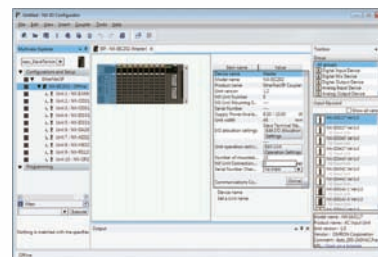

The NX-IO Configurator is software to set up and maintain EtherNet/IP coupler units and NX I/O Units on an EtherNet/IP coupler

FA Integrated Tool Package CX-One

CJ Series
or
PLC from
other
vendors



CJ Programmable Controller*2



PLC from other vendors*3



EtherNet/IP™

W4S1-□□□
Industrial Switching Hub



IO-Link



IO-Link

*2. Dedicated software is required to use the CJ PLC or other vendor's PLC with the NX Safety Units.

*3. Connect the NX I/O system to a PLC from another vendor via a switching hub and set up with the CX-One.

Various software components help reduce programming time

The Sysmac Library is a collection of software functional components that can be used in programs for the NJ/NX Machine Automation Controllers or Industrial PC Platform NY IPC Machine Controllers.

Packed with Omron's rich technical know-how on control programs, the Sysmac Library makes advanced control easy.



Easy-to-obtain Library

The Sysmac Library is freely available to download from Omron website.

These software components specially designed for the NJ/NX/NY Controller can be used in your programs without the need for additional work.

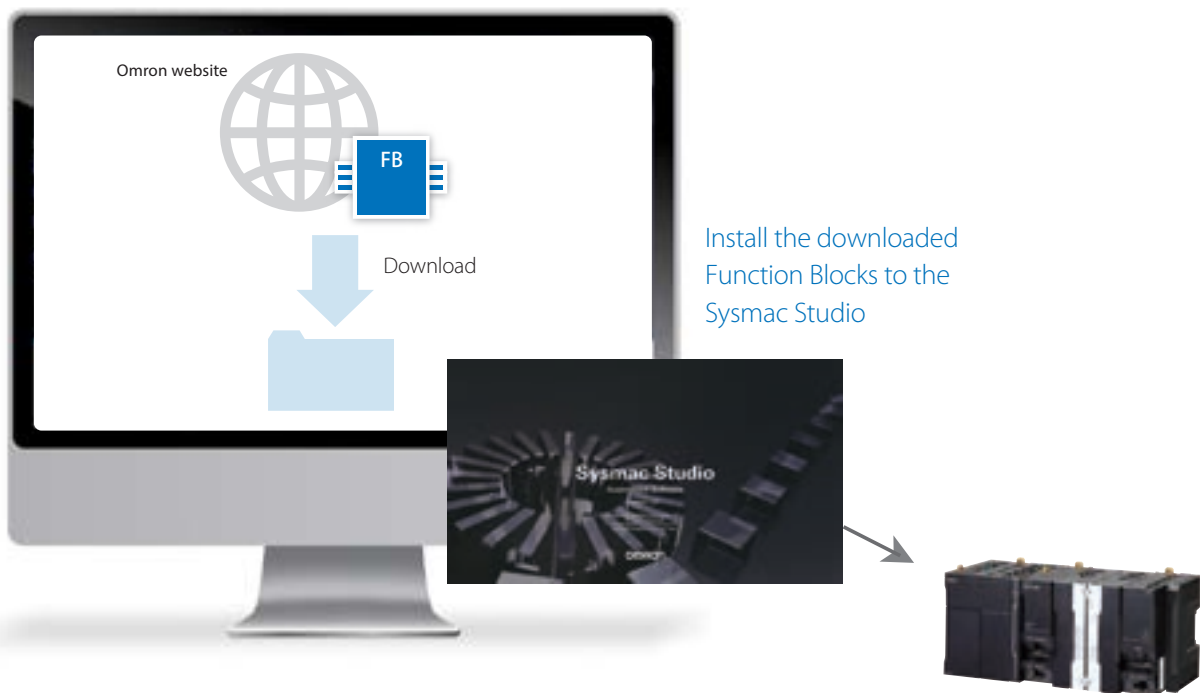

Download from

http://www.ia.omron.com/sysmac_library/

Application example (1) Load cells

Press fit using servo press

Improve both speed and quality of the press-fit process

Load data is collected in synchronization with the CPU cycle for high-speed measurement, high-speed servo press control, and precision improvement.



Previous issues

- Wait time must be considered to operate the dedicated press controller together with the main PLC.
- Load, position, and torque data collected at the same time cannot be checked from the host device.

Solution using Sysmac

- One CPU system capable of switching between position, velocity, and torque control without stopping
- Fastest control cycle of 125 μs and servo press function using software for required control
- High-speed measurement and control by collecting load data synchronized with servo data (position and torque data).

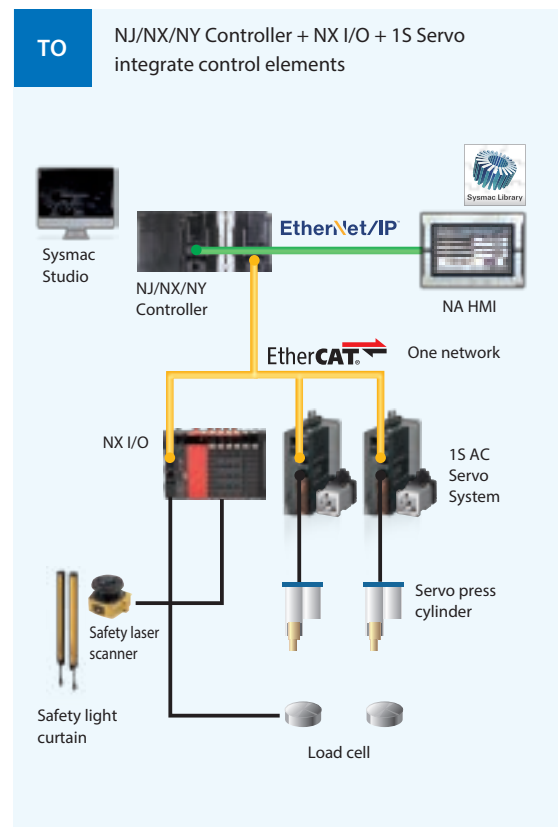
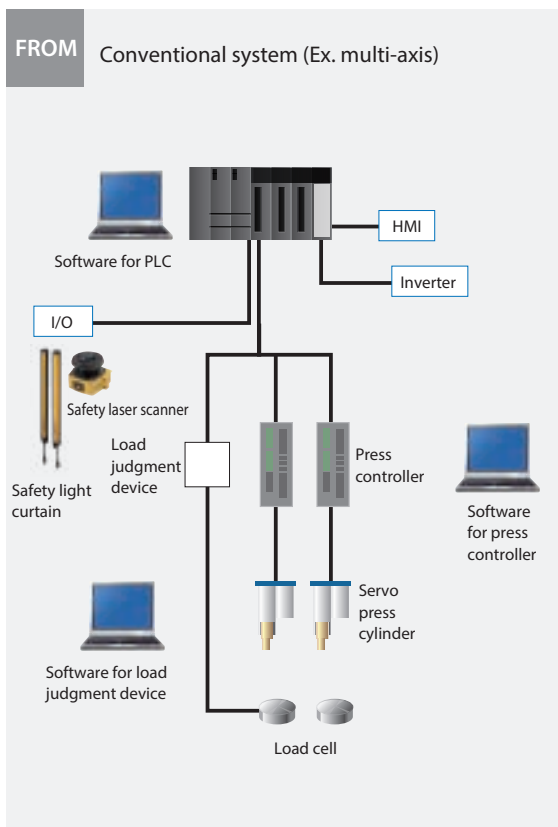

Application example (2) Temperature control

Packaging machines and molding machines (Temperature/motion/weighing)

Reduce material and design costs to implement temperature control

TCO can be reduced by eliminating the need for the dedicated temperature controller and reducing inventory control work and communications programming work.



Previous issues

- Communications networks are selected for each device, and dedicated software for each component is used.
- Ladder program and memory configuration for communications are required.

Solution using Sysmac

- Dedicated controllers, dedicated software, separate networks, and separate programs are no longer required

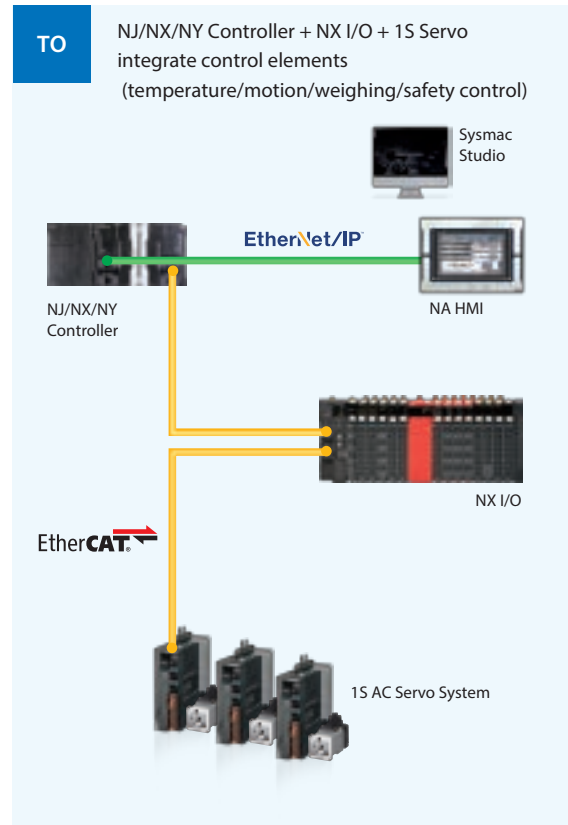
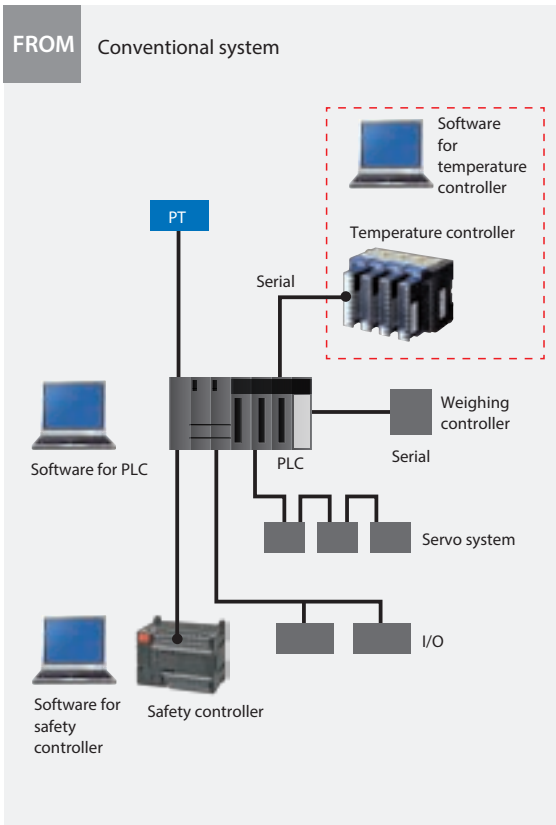

Application example (3) Photoelectric sensors and proximity sensors

Improving system commissioning and changeover efficiency

Reduce work by individual identification

IO-Link sensors allow you to check individual sensor identifications in batches without going to the site, which results in a significant reduction of commissioning time.

Previous issues

- During system commissioning or changeover, operators have to perform the I/O check for each of the thousands of sensors installed on the line, and it took an enormous amount of time.
- Incorrect sensor installation creates unnecessary extra work.

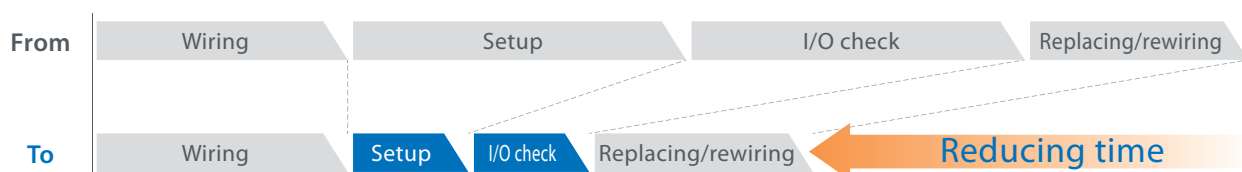

* The graph above is a conceptual illustration.

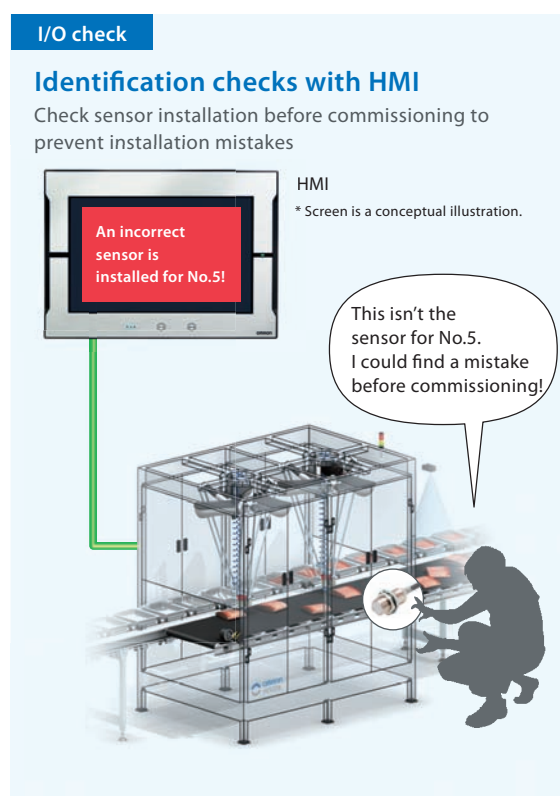
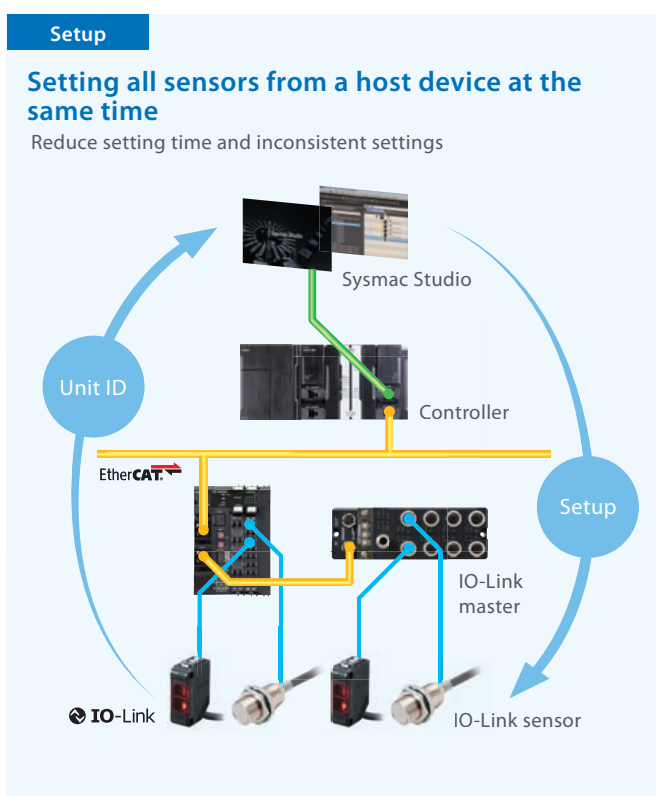

Application example (4) Traceability using RFID

Improving system commissioning efficiency

Reduce time required for system design and wiring

Distributed installation of RFID units simplifies system design and wiring, even for high-mix production.



Previous issues

- When the system configuration is changed, it requires considerable time and effort to re-design and debug the entire program because ID sensor units cannot be distributed.
- It is difficult and time-consuming to wire an additional antenna to the ID sensor unit that is located away from it.

Solution using Sysmac

- The RFID units can be installed near each antenna, allowing addition or change of programs only where necessary and reducing wiring time

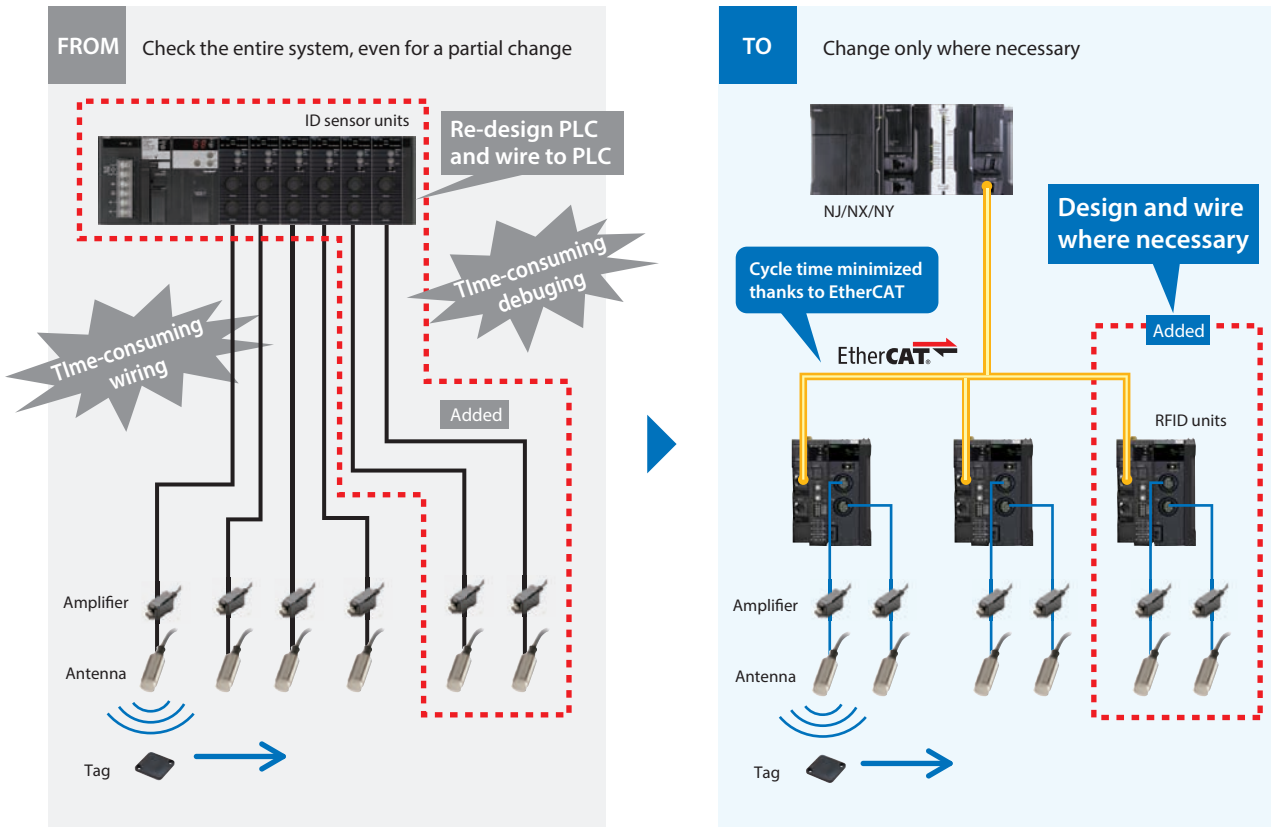

EtherNet/IP connection is also available.

Slave Terminals NX Series

Ordering Information

Applicable standards

Refer to the OMRON website (www.ia.omron.com) or ask your OMRON representative for the most recent applicable standards for each model.

Communications Coupler Units

● EtherCAT Coupler Units

Product name	Communications cycle in DC Mode	Current consumption	Maximum I/O power supply current	Model
	250 to 4000 μ s *2	1.45 W or lower	4 A	NX-ECC201
	250 to 4000 μ s *2		10 A	NX-ECC202
	125 to 10000 μ s *2	1.25 W or lower		NX-ECC203

*1. One End Cover NX-END01 is provided with the EtherCAT Coupler Unit.



*2. This depends on the specifications of the EtherCAT master. For example, the values are as follows when the EtherCAT Coupler Unit is connected to the built-in EtherCAT port on an NJ5-series CPU Unit: 500 μ s, 1,000 μ s, 2,000 μ s, and 4,000 μ s. For the specifications of the built-in EtherCAT port, refer to the user's manual for the built-in EtherCAT port on the connected CPU Unit or the Industrial PC. This depends on the Unit configuration.

● EtherNet/IP Coupler Unit



Product name	Current consumption	Maximum I/O power supply current	Model
	1.60 W or lower	10 A	NX-EIC202

* One End Cover NX-END01 is provided with the EtherCAT Coupler Unit.

Digital Input Units



Product Name	Specifications					Model
	Number of points	Internal I/O common	Rated input voltage	I/O refreshing method	ON/OFF response time	
 (Screwless Clamping Terminal Block, 12 mm Width)	4 points	NPN	12 to 24 VDC	Switching Synchronous I/O refreshing and Free-Run refreshing	20 μ s max./400 μ s max.	NX-ID3317
			24 VDC		100 ns max./100 ns max.	NX-ID3343
		PNP	12 to 24 VDC	Switching Synchronous I/O refreshing and Free-Run refreshing	100 ns max./100 ns max.	NX-ID3344
						Input refreshing with input changed time only *
	8 points	NPN	24 VDC	Switching Synchronous I/O refreshing and Free-Run refreshing	20 μ s max./400 μ s max.	NX-ID3443
						Input refreshing with input changed time only *
		PNP	24 VDC	Switching Synchronous I/O refreshing and Free-Run refreshing	20 μ s max./400 μ s max.	NX-ID4342
						Input refreshing with input changed time only *
16 points	NPN	24 VDC	Switching Synchronous I/O refreshing and Free-Run refreshing	20 μ s max./400 μ s max.	NX-ID5342	
	PNP				NX-ID5442	
 (M3 Screw Terminal Block, 30 mm Width)	16 points	For both NPN/PNP	24 VDC	Switching Synchronous I/O refreshing and Free-Run refreshing	20 μ s max./400 μ s max.	NX-ID5142-1



Slave Terminals NX Series

Product Name	Specifications					Model
	Number of points	Internal I/O common	Rated input voltage	I/O refreshing method	ON/OFF response time	
 (MIL Connector, 30 mm Width)	16 points	For both NPN/PNP	24 VDC	Switching Synchronous I/O refreshing and Free-Run refreshing	20 μs max./400 μs max.	NX-ID5142-5
	32 points					NX-ID6142-5
 (Fujitsu Connector, 30 mm Width)	32 points	For both NPN/PNP	24 VDC	Switching Synchronous I/O refreshing and Free-Run refreshing	20 μs max./400 μs max.	NX-ID6142-6
 (Screwless Clamping Terminal Block, 12 mm Width)	4 points	200 to 240 VAC, 50/60 Hz (170 to 264 VAC, ±3 Hz)		Free-Run refreshing	10 ms max./40 ms max.	NX-IA3117

* To use input refreshing with input changed time, the EtherCAT Coupler Unit with unit version 1.1 or later and the Sysmac Studio version 1.07 or higher are required.



Digital Output Units

Product Name	Specifications						Model	
	Number of points	Internal I/O common	Maximum value of load current	Rated voltage	I/O refreshing method	ON/OFF response time		
 (Screwless Clamping Terminal Block, 12 mm Width)	2	NPN	0.5 A/point, 1 A/Unit	24 VDC	Output refreshing with specified time stamp only *	300 ns max./300 ns max.	NX-OD2154	
		PNP					NX-OD2258	
	4	NPN	0.5 A/point, 2 A/Unit	12 to 24 VDC	Switching Synchronous I/O refreshing and Free-Run refreshing		0.1 ms max./0.8 ms max.	NX-OD3121
				24 VDC			300 ns max./300 ns max.	NX-OD3153
		PNP	2 A/point, 8 A/Unit	24 VDC			0.5 ms max./1.0 ms max.	NX-OD3256
				24 VDC			300 ns max./300 ns max.	NX-OD3257
	8	NPN	0.5 A/point, 4 A/Unit	12 to 24 VDC			0.1 ms max./0.8 ms max.	NX-OD4121
		PNP		24 VDC			0.5 ms max./1.0 ms max.	NX-OD4256
	16	NPN	0.5 A/point, 4 A/Unit	12 to 24 VDC			0.1 ms max./0.8 ms max.	NX-OD5121
		PNP		24 VDC			0.5 ms max./1.0 ms max.	NX-OD5256
 (M3 Screw Terminal Block, 30 mm Width)	16	NPN	0.5 A/point, 5 A/Unit	12 to 24 VDC	Switching Synchronous I/O refreshing and Free-Run refreshing	0.1 ms max./0.8 ms max.	NX-OD5121-1	
		PNP		24 VDC			0.5 ms max./1.0 ms max.	NX-OD5256-1

Product Name	Specifications						Model
	Number of points	Internal I/O common	Maximum value of load current	Rated voltage	I/O refreshing method	ON/OFF response time	
Transistor Output Unit  (MIL Connector, 30 mm Width)	16	NPN	0.5 A/point, 2 A/Unit	12 to 24 VDC	Switching Synchronous I/O refreshing and Free- Run refreshing	0.1 ms max./0.8 ms max.	NX-OD5121-5
		PNP		24 VDC		0.5 ms max./1.0 ms max.	NX-OD5256-5
	32	NPN	0.5 A/point, 2 A/common, 4 A/Unit	12 to 24 VDC		0.1 ms max./0.8 ms max.	NX-OD6121-5
		PNP		24 VDC		0.5 ms max./1.0 ms max.	NX-OD6256-5
Transistor Output Unit  (Fujitsu Connector, 30 mm Width)	32	NPN	0.5 A/point, 2 A/common, 4 A/Unit	12 to 24 VDC	Switching Synchronous I/O refreshing and Free- Run refreshing	0.1 ms max./0.8 ms max.	NX-OD6121-6
Relay Output Unit  (Screwless Clamping Terminal Block, 12 mm Width/ 24 mm Width)	2	Relay type: N.O.	250 VAC/2 A (cosφ=1), 250 VAC/2 A (cosφ=0.4), 24 VDC/2 A, 4 A/Unit	Free-Run refreshing	15 ms max./15 ms max.	NX-OC2633	
		Relay type: N.O.+N.C.				NX-OC2733	
	8	Relay type: N.O.	250 VAC/2 A (cosφ=1), 250 VAC/2 A (cosφ=0.4), 24 VDC/2 A, 8 A/Unit			Free-Run refreshing	15 ms max./15 ms max.

* To use output refreshing with specified time stamp, the EtherCAT Coupler Unit with unit version 1.1 or later and the Sysmac Studio version 1.07 or higher are required.

Digital Mixed I/O Units

Product Name	Specifications					Model
	Number of points	Internal I/O common	Maximum value of load current	I/O refreshing method	ON/OFF response time	
DC Input/Transistor Output Unit  (MIL Connector, 30 mm Width)	Outputs: 16 points Inputs: 16 points	Outputs: NPN Inputs: For both NPN/ PNP	Outputs: 12 to 24 VDC Inputs: 24 VDC	Switching Synchronous I/O refreshing and Free-Run refreshing	Outputs: 0.1 ms max./0.8 ms max. Inputs: 20 μs max./400 μs max.	NX-MD6121-5
		Outputs: PNP Inputs: For both NPN/ PNP	Outputs: 24 VDC Inputs: 24 VDC		Outputs: 0.5 ms max./1.0 ms max. Inputs: 20 μs max./400 μs max.	NX-MD6256-5
DC Input/Transistor Output Unit  (Fujitsu Connector, 30 mm Width)	Outputs: 16 points Inputs: 16 points	Outputs: NPN Inputs: For both NPN/ PNP	Outputs: 12 to 24 VDC Inputs: 24 VDC	Switching Synchronous I/O refreshing and Free-Run refreshing	Outputs: 0.1 ms max./0.8 ms max. Inputs: 20 μs max./400 μs max.	NX-MD6121-6

Connection Patterns for Connector-Terminal Block Conversion Units

Pattern	Configuration	Number of connectors	Branching
A	<p>Connecting Cable Connector-Terminal Block Conversion Unit 20 or 40 terminals</p>	1	None
B	<p>Connecting Cable with two branches Connector-Terminal Block Conversion Unit 20 terminals 20 terminals</p>		2 branches
C	<p>Connecting Cable Connector-Terminal Block Conversion Unit 20 terminals 20 terminals</p>	2	None

Connections to Connector-Terminal Block Conversion Units

Unit	I/O capacity	Number of connectors	Polarity	Connection pattern	Connecting Cable *1	Connector-Terminal Block Conversion Unit	Wiring method	Common terminal
NX-ID5142-5	16 inputs	1 MIL connector	NPN/ PNP	A	XW2Z-□□□X	XW2R-□20GD-T	Depends on model *3	None
					XW2Z-□□□X	XW2D-20G6	Phillips screw	None
NX-ID6142-5	32 inputs	1 MIL connector	NPN/ PNP	A	XW2Z-□□□PM	XW2R-□34GD-C2	Depends on model *3	None
				A	XW2Z-□□□K	XW2D-40G6	Phillips screw	None
				B	XW2Z-□□□N	XW2R-□20GD-T (2 Units)	Depends on model *3	None
				B	XW2Z-□□□N	XW2C-20G5-IN16 (2 Units) *2	Phillips screw	Yes
				B	XW2Z-□□□N	XW2C-20G6-IO16 (2 Units)	Phillips screw	Yes
				B	XW2Z-□□□N	XW2D-20G6 (2 Units)	Phillips screw	None
				B	XW2Z-□□□N	XW2E-20G5-IN16 (2 Units) *2	Phillips screw	Yes
NX-ID6142-6	32 inputs	1 Fujitsu connector	NPN/ PNP	A	XW2Z-□□□PF	XW2R-□34GD-C1	Depends on model *3	None
				A	XW2Z-□□□B	XW2D-40G6	Phillips screw	None
				B	XW2Z-□□□D	XW2R-□20GD-T (2 Units)	Depends on model *3	None
				B	XW2Z-□□□D	XW2C-20G5-IN16 (2 Units) *2	Phillips screw	Yes
				B	XW2Z-□□□D	XW2C-20G6-IO16 (2 Units)	Phillips screw	Yes
				B	XW2Z-□□□D	XW2D-20G6 (2 Units)	Phillips screw	None
				B	XW2Z-□□□D	XW2E-20G5-IN16 (2 Units) *2	Phillips screw	Yes
NX-OD5121-5	16 outputs	1 MIL connector	NPN	A	XW2Z-□□□X	XW2R-□20GD-T	Depends on model *3	None
				A	XW2Z-□□□X	XW2D-20G6	Phillips screw	None
NX-OD5256-5	16 outputs	1 MIL connector	PNP	A	XW2Z-□□□X	XW2R-□20GD-T	Depends on model *3	None
				A	XW2Z-□□□X	XW2D-20G6	Phillips screw	None

Unit	I/O capacity	Number of connectors	Polarity	Connection pattern	Connecting Cable *1	Connector-Terminal Block Conversion Unit	Wiring method	Common terminal
NX-OD6121-5	32 inputs	1 MIL connector	NPN	A	XW2Z-□□□PM	XW2R-□34GD-C4	Depends on model *3	None
				A	XW2Z-□□□K	XW2D-40G6	Phillips screw	None
				B	XW2Z-□□□N	XW2R-□20GD-T (2 Units)	Depends on model *3	None
				B	XW2Z-□□□N	XW2C-20G6-IO16 (2 Units)	Phillips screw	Yes
				B	XW2Z-□□□N	XW2D-20G6 (2 Units)	Phillips screw	None
NX-OD6121-6	32 inputs	1 Fujitsu connector	NPN	A	XW2Z-□□□PF	XW2R-□34GD-C3	Depends on model *3	None
				A	XW2Z-□□□B	XW2D-40G6	Phillips screw	None
				B	XW2Z-□□□L	XW2R-□20GD-T (2 Units)	Depends on model *3	None
				B	XW2Z-□□□L	XW2C-20G6-IO16 (2 Units)	Phillips screw	Yes
				B	XW2Z-□□□L	XW2D-20G6 (2 Units)	Phillips screw	None
NX-OD6256-5	32 inputs	1 MIL connector	PNP	A	XW2Z-□□□PM	XW2R-□34GD-C4	Depends on model *3	None
				A	XW2Z-□□□K	XW2D-40G6	Phillips screw	None
				B	XW2Z-□□□N	XW2R-□20GD-T (2 Units)	Depends on model *3	None
				B	XW2Z-□□□N	XW2C-20G6-IO16 (2 Units)	Phillips screw	Yes
				B	XW2Z-□□□N	XW2D-20G6 (2 Units)	Phillips screw	None
NX-MD6121-5	16 outputs	1 MIL connector	NPN/ PNP	C	XW2Z-□□□X	XW2R-□20GD-T	Depends on model *3	None
				C	XW2Z-□□□X	XW2D-20G6	Phillips screw	None
	16 outputs	1 MIL connector	NPN	C	XW2Z-□□□X	XW2R-□20GD-T	Depends on model *3	None
				C	XW2Z-□□□X	XW2D-20G6	Phillips screw	None
NX-MD6121-6	16 outputs	1 Fujitsu connector	NPN/ PNP	C	XW2Z-□□□A	XW2R-□20GD-T	Depends on model *3	None
				C	XW2Z-□□□A	XW2C-20G5-IN16 *2	Phillips screw	Yes
				C	XW2Z-□□□A	XW2C-20G6-IO16	Phillips screw	Yes
				C	XW2Z-□□□A	XW2D-20G6	Phillips screw	None
				C	XW2Z-□□□A	XW2E-20G5-IN16 *2	Phillips screw	Yes
	16 outputs	1 Fujitsu connector	NPN	C	XW2Z-□□□A	XW2R-□20GD-T	Depends on model *3	None
				C	XW2Z-□□□A	XW2C-20G6-IO16	Phillips screw	Yes
				C	XW2Z-□□□A	XW2D-20G6	Phillips screw	None
NX-MD6256-5	16 outputs	1 MIL connector	NPN/ PNP	C	XW2Z-□□□X	XW2R-□20GD-T	Depends on model *3	None
				C	XW2Z-□□□X	XW2D-20G6	Phillips screw	None
	16 outputs	1 MIL connector	PNP	C	XW2Z-□□□X	XW2R-□20GD-T	Depends on model *3	None
				C	XW2Z-□□□X	XW2D-20G6	Phillips screw	None

Note: For other models and specifications that are not listed above, refer to the *XW2R Series Connector-Terminal Block Conversion Units Catalog* (Cat. No. G077) and *XW2R Datasheets*.

*1. □□□ in the model number indicates the cable length. Refer to the *XW2Z Datasheet* for details.

*2. The inputs are NPN. For PNP inputs, reverse the polarity of the external power supply connections to the power supply terminals on the Connector-Terminal Block Conversion Unit.

*3. The wiring methods vary depending on the Connector-Terminal Block Conversion Unit. □ in the model number indicates the wiring method.

- J = Phillips screw
- E = Slotted screw (rise up)
- P = Push-in spring

Connection Patterns for I/O Relay Terminals

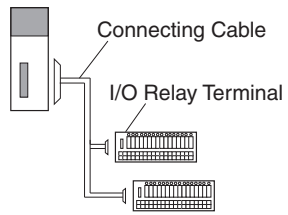
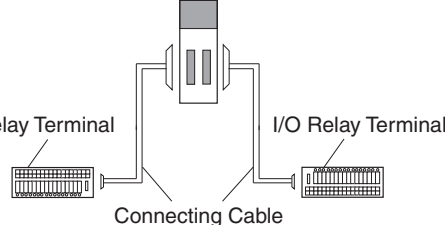
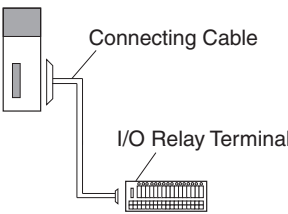
Pattern	Configuration	Number of connectors	Branching
A		1	2 branches
E		2	None
F		1	

Connections to I/O Relay Terminals

Unit	I/O capacity	Number of connectors	Polarity	Connection pattern	Number of branches	Connecting Cable *1	I/O Relay Terminal	Wiring method
NX-ID5142-5	16 inputs	1 MIL connector	NPN	F	None	XW2Z-RO□C	G7TC-ID16	Phillips screw
				F	None	XW2Z-RO□C	G7TC-IA16	Phillips screw
				F	None	XW2Z-RO□C	G70V-SID16P	Push-in spring
				F	None	XW2Z-RO□C	G70V-SID16P-C16	Push-in spring
			PNP	F	None	XW2Z-RO□C	G70V-SID16P-1	Push-in spring
				F	None	XW2Z-RO□C	G70V-SID16P-1-C16	Push-in spring
NX-ID6142-5	32 inputs	1 MIL connector	NPN	A	2	XW2Z-RO□-□-D1	G7TC-ID16	Phillips screw
				A	2	XW2Z-RO□-□-D1	G7TC-IA16	Phillips screw
				A	2	XW2Z-RO□-□-D1	G70V-SID16P	Push-in spring
				A	2	XW2Z-RO□-□-D1	G70V-SID16P-C16	Push-in spring
			PNP	A	2	XW2Z-RO□-□-D1	G70V-SID16P-1	Push-in spring
				A	2	XW2Z-RO□-□-D1	G70V-SID16P-1-C16	Push-in spring
NX-ID6142-6	32 inputs	1 Fujitsu connector	NPN	A	2	XW2Z-RI□C-□	G7TC-ID16	Phillips screw
				A	2	XW2Z-RI□C-□	G7TC-IA16	Phillips screw
				A	2	XW2Z-RI□C-□	G70V-SID16P	Push-in spring
				A	2	XW2Z-RI□C-□	G70V-SID16P-C16	Push-in spring
			PNP	A	2	XW2Z-RI□C-□	G70V-SID16P-1	Push-in spring
				A	2	XW2Z-RI□C-□	G70V-SID16P-1-C16	Push-in spring
NX-OD5121-5	16 outputs	1 MIL connector	NPN	F	None	XW2Z-RO□C	G7TC-OC08	Phillips screw
				F	None	XW2Z-RO□C	G70D-SOC08	Phillips screw
				F	None	XW2Z-RO□C	G70R-SOC08 *2	Phillips screw
				F	None	XW2Z-RO□C	G7TC-OC16	Phillips screw
				F	None	XW2Z-RO□C	G70D-SOC16	Phillips screw
				F	None	XW2Z-RO□C	G70D-VSOC16	Phillips screw
				F	None	XW2Z-RO□C	G70D-FOM16	Phillips screw
				F	None	XW2Z-RO□C	G70D-VFOM16	Phillips screw
				F	None	XW2Z-RO□C	G70A-ZOC16-3	Phillips screw
				F	None	XW2Z-RO□C	G70V-SOC16P	Push-in spring
F	None	XW2Z-RO□C	G70V-SOC16P-C4	Push-in spring				

Unit	I/O capacity	Number of connectors	Polarity	Connection pattern	Number of branches	Connecting Cable *1	I/O Relay Terminal	Wiring method
NX-OD5256-5	16 outputs	1 MIL connector	PNP	F	None	XW2Z-RI□C	G7TC-OC16-1	Phillips screw
				F	None	XW2Z-RO□C	G70D-SOC16-1	Phillips screw
				F	None	XW2Z-RO□C	G70D-FOM16-1	Phillips screw
				F	None	XW2Z-RO□C	G70A-ZOC16-4	Phillips screw
				F	None	XW2Z-RO□C	G70V-SOC16P-1	Push-in spring
				F	None	XW2Z-RO□C	G70V-SOC16P-1-C4	Push-in spring
NX-OD6121-5	32 outputs	1 MIL connector	NPN	A	2	XW2Z-RO□-□-D1	G7TC-OC16	Phillips screw
				A	2	XW2Z-RO□-□-D1	G7TC-OC08	Phillips screw
				A	2	XW2Z-RO□-□-D1	G70D-SOC16	Phillips screw
				A	2	XW2Z-RO□-□-D1	G70D-FOM16	Phillips screw
				A	2	XW2Z-RO□-□-D1	G70D-VSOC16	Phillips screw
				A	2	XW2Z-RO□-□-D1	G70D-VFOM16	Phillips screw
				A	2	XW2Z-RO□-□-D1	G70A-ZOC16-3 and Relay	Phillips screw
				A	2	XW2Z-RO□-□-D1	G70R-SOC08 *2	Phillips screw
				A	2	XW2Z-RO□-□-D1	G70D-SOC08	Phillips screw
				A	2	XW2Z-RO□-□-D1	G70V-SOC16P	Push-in spring
NX-OD6121-6	32 outputs	1 Fujitsu connector	NPN	A	2	XW2Z-RO□C-□	G7TC-OC16	Phillips screw
				A	2	XW2Z-RO□C-□	G7TC-OC08	Phillips screw
				A	2	XW2Z-RO□C-□	G70D-SOC16	Phillips screw
				A	2	XW2Z-RO□C-□	G70D-FOM16	Phillips screw
				A	2	XW2Z-RO□C-□	G70D-VSOC16	Phillips screw
				A	2	XW2Z-RO□C-□	G70D-VFOM16	Phillips screw
				A	2	XW2Z-RO□C-□	G70A-ZOC16-3 and Relay	Phillips screw
				A	2	XW2Z-RO□C-□	G70R-SOC08 *2	Phillips screw
				A	2	XW2Z-RO□C-□	G70D-SOC08	Phillips screw
				A	2	XW2Z-RO□C-□	G70V-SOC16P	Push-in spring
NX-OD6256-5	32 outputs	1 MIL connector	PNP	A	2	XW2Z-RI□-□-D1	G7TC-OC16-1	Phillips screw
				A	2	XW2Z-RO□-□-D1	G70D-SOC16-1	Phillips screw
				A	2	XW2Z-RO□-□-D1	G70D-FOM16-1	Phillips screw
				A	2	XW2Z-RO□-□-D1	G70A-ZOC16-4 and Relay	Phillips screw
				A	2	XW2Z-RO□-□-D1	G70V-SOC16P-1	Push-in spring
				A	2	XW2Z-RO□-□-D1	G70V-SOC16P-1-C4	Push-in spring
NX-MD6121-5	16 inputs	1 MIL connector	NPN	E	None	XW2Z-RO□C	G7TC-ID16	Phillips screw
				E	None	XW2Z-RO□C	G7TC-IA16	Phillips screw
				E	None	XW2Z-RO□C	G70V-SID16P	Push-in spring
				E	None	XW2Z-RO□C	G70V-SID16P-C16	Push-in spring
	16 outputs	1 MIL connector	NPN	E	None	XW2Z-RO□C	G7TC-OC16	Phillips screw
				E	None	XW2Z-RO□C	G7TC-OC08	Phillips screw
				E	None	XW2Z-RO□C	G70D-SOC16	Phillips screw
				E	None	XW2Z-RO□C	G70D-FOM16	Phillips screw
				E	None	XW2Z-RO□C	G70D-VSOC16	Phillips screw
				E	None	XW2Z-RO□C	G70D-VFOM16	Phillips screw
				E	None	XW2Z-RO□C	G70A-ZOC16-3 and Relay	Phillips screw
				E	None	XW2Z-RO□C	G70R-SOC08 *2	Phillips screw
				E	None	XW2Z-RO□C	G70D-SOC08	Phillips screw
				E	None	XW2Z-RO□C	G70V-SOC16P	Push-in spring
E	None	XW2Z-RO□C	G70V-SOC16P-C4	Push-in spring				

Slave Terminals NX Series

Unit	I/O capacity	Number of connectors	Polarity	Connection pattern	Number of branches	Connecting Cable *1	I/O Relay Terminal	Wiring method
NX-MD6121-6	16 inputs	1 Fujitsu connector	NPN	E	None	XW2Z-R□C	G7TC-ID16	Phillips screw
				E	None	XW2Z-R□C	G7TC-IA16	Phillips screw
				E	None	XW2Z-R□C	G70V-SID16P	Push-in spring
				E	None	XW2Z-R□C	G70V-SID16P-C16	Push-in spring
	16 outputs	1 Fujitsu connector	NPN	E	None	XW2Z-R□C	G7TC-OC16	Phillips screw
				E	None	XW2Z-R□C	G7TC-OC08	Phillips screw
				E	None	XW2Z-R□C	G70D-SOC16	Phillips screw
				E	None	XW2Z-R□C	G70D-FOM16	Phillips screw
				E	None	XW2Z-R□C	G70D-VSOC16	Phillips screw
				E	None	XW2Z-R□C	G70D-VFOM16	Phillips screw
				E	None	XW2Z-R□C	G70A-ZOC16-3 and Relay	Phillips screw
				E	None	XW2Z-R□C	G70R-SOC08 *2	Phillips screw
				E	None	XW2Z-R□C	G70D-SOC08	Phillips screw
				E	None	XW2Z-R□C	G70V-SOC16P	Push-in spring
E	None	XW2Z-R□C	G70V-SOC16P-C4	Push-in spring				
NX-MD6256-5	16 inputs	1 MIL connector	PNP	E	None	XW2Z-RO□C	G70V-SID16P-1	Push-in spring
				E	None	XW2Z-RO□C	G70V-SID16P-1-C16	Push-in spring
	16 outputs	1 MIL connector	PNP	E	None	XW2Z-RO□C	G7TC-OC16-1	Phillips screw
				E	None	XW2Z-RI□C	G70D-SOC16-1	Phillips screw
				E	None	XW2Z-RI□C	G70D-FOM16-1	Phillips screw
				E	None	XW2Z-RI□C	G70A-ZOC16-4 and Relay	Phillips screw
				E	None	XW2Z-RI□C	G70V-SOC16P-1	Push-in spring
				E	None	XW2Z-RI□C	G70V-SOC16P-1-C4	Push-in spring

Note: 1. For other models and specifications that are not listed above, refer to the datasheets.

2. The G70V Series includes models that provide internal connections. Refer to the *G70V Datasheet* (Cat. No. J215) for details.

3. The G70A is a socket only. Mountable relays and timers are sold separately.



*1. □ in the model number indicates the cable length. Refer to the *XW2Z-R Datasheet* (Cat. No. G126) for details.

*2. Product no longer available to order.



High-speed Analog Input Units

Product name	Specification								Model
	Number of points	Input range	Resolution	Input method	Conversion time	Trigger input section		I/O refreshing method	
						Number of points	Internal I/O common		
High-speed Analog Input Units 	4 points	-10 to +10V -5 to +5V 0 to 10V 0 to 5V 1 to 5V 0 to 20mA 4 to 20mA	<ul style="list-style-type: none"> Input range of -10 to 10 V or -5 to 5 V: 1/64,000 (full scale) Other input range: 1/32,000 (full scale) 	Differential input	5 μs per channel	4	NPN	Synchronous I/O refreshing	NX-HAD401
							PNP		NX-HAD402

Analog Input Units



Product name	Specification									Model
	Number of points	Input range	Resolution	Conversion value, decimal number (0 to 100%)	Over all accuracy (25°C)	Input method	Conversion time	Input impedance	I/O refreshing method	
Voltage Input type 	2 points	-10 to +10 V	1/8000	-4000 to 4000	±0.2% (full scale)	Single-ended input Differential input	250 μs/point	1 MΩ min.	Free-Run refreshing	NX-AD2603 NX-AD2604
			1/30000	-15000 to 15000	±0.1% (full scale)	Differential input	10 μs/point		Selectable Synchronous I/O refreshing or Free-Run refreshing	NX-AD2608
	4 points		1/8000	-4000 to 4000	±0.2% (full scale)	Single-ended input Differential input	250 μs/point		Free-Run refreshing	NX-AD3603 NX-AD3604
			1/30000	-15000 to 15000	±0.1% (full scale)	Differential input	10 μs/point		Selectable Synchronous I/O refreshing or Free-Run refreshing	NX-AD3608
	8 points		1/8000	-4000 to 4000	±0.2% (full scale)	Single-ended input Differential input	250 μs/point		Free-Run refreshing	NX-AD4603 NX-AD4604
			1/30000	-15000 to 15000	±0.1% (full scale)	Differential input	10 μs/point		Selectable Synchronous I/O refreshing or Free-Run refreshing	NX-AD4608
Current Input type 	2 points	4 to 20 mA	1/8000	0 to 8000	±0.2% (full scale)	Single-ended input Differential input	250 μs/point	250 Ω	Free-Run refreshing	NX-AD2203 NX-AD2204
			1/30000	0 to 30000	±0.1% (full scale)	Differential input	10 μs/point		Selectable Synchronous I/O refreshing or Free-Run refreshing	NX-AD2208
	4 points		1/8000	0 to 8000	±0.2% (full scale)	Single-ended input Differential input	250 μs/point		Free-Run refreshing	NX-AD3203 NX-AD3204
			1/30000	0 to 30000	±0.1% (full scale)	Differential input	10 μs/point		Selectable Synchronous I/O refreshing or Free-Run refreshing	NX-AD3208
	8 points		1/8000	0 to 8000	±0.2% (full scale)	Single-ended input Differential input	250 μs/point		Free-Run refreshing	NX-AD4203 NX-AD4204
			1/30000	0 to 30000	±0.1% (full scale)	Differential input	10 μs/point		Selectable Synchronous I/O refreshing or Free-Run refreshing	NX-AD4208

Analog Output Units



Product name	Specification							Model
	Number of points	Input range	Resolution	Output setting value, decimal number (0 to 100%)	Over all accuracy (25°C)	Conversion time	I/O refreshing method	
Voltage Output type 	2 points	-10 to +10 V	1/8000	-4000 to 4000	±0.3% (full scale)	250 μs/point	Free-Run refreshing	NX-DA2603
			1/30000	-15000 to 15000	±0.1% (full scale)	10 μs/point	Selectable Synchronous I/O refreshing or Free-Run refreshing	NX-DA2605
	4 points		1/8000	-4000 to 4000	±0.3% (full scale)	250 μs/point	Free-Run refreshing	NX-DA3603
			1/30000	-15000 to 15000	±0.1% (full scale)	10 μs/point	Selectable Synchronous I/O refreshing or Free-Run refreshing	NX-DA3605
Current Output type 	2 points	4 to 20 mA	1/8000	0 to 8000	±0.3% (full scale)	250 μs/point	Free-Run refreshing	NX-DA2203
			1/30000	0 to 30000	±0.1% (full scale)	10 μs/point	Selectable Synchronous I/O refreshing or Free-Run refreshing	NX-DA2205
	4 points		1/8000	0 to 8000	±0.3% (full scale)	250 μs/point	Free-Run refreshing	NX-DA3203
			1/30000	0 to 30000	±0.1% (full scale)	10 μs/point	Selectable Synchronous I/O refreshing or Free-Run refreshing	NX-DA3205

Temperature Control Units/Temperature Input Units/Heater Burnout Detection Units

● Temperature Control Units

Product name	Specification								Model
	Number of channels	Input type	Output	Output capacity	CT Input capacity	Control type	Conversion time	I/O refreshing method	
Temperature Control Unit 2Ch type 	2 Ch	Multi-input (Thermocouple and Resistance thermometer)	Voltage output (for driving SSR)	2 points	2 points	Standard Control	50 m sec	Free-Run refreshing	NX-TC2405
					None	Standard Control			NX-TC2406
			Voltage output (for driving SSR)	4 points	None	Heating and Cooling Control			NX-TC2407
			Linear current output	2 points	None	Standard Control			NX-TC2408
Temperature Control Unit 4Ch type 	4 Ch		Voltage output (for driving SSR)	4 points	4 points	Standard Control			NX-TC3405
					None	Standard Control			NX-TC3406
			Voltage output (for driving SSR)	8 points	None	Heating and Cooling Control			NX-TC3407
			Linear current output	4 points	None	Standard Control			NX-TC3408

● Temperature Input Units

Product name	Specification							Model
	Number of points	Input type	Resolution (25°C)	Overall accuracy (25°C)	Conversion time	I/O refreshing method	Terminals	
Thermocouple Input type 	2 points	Thermocouple	0.1°C max. *1	Refer to your OMRON website for details.	250 ms/Unit	Free-Run refreshing	16 Terminals	NX-TS2101
	4 points						16 Terminals X 2	NX-TS3101
	2 points		0.01°C max.		10 ms/Unit		16 Terminals	NX-TS2102
	4 points				16 Terminals X 2		NX-TS3102	
	2 points		0.001°C max.		60 ms/Unit		16 Terminals	NX-TS2104
	4 points						16 Terminals X 2	NX-TS3104
Resistance Thermometer Input type 	2 points	Resistance Thermometer (Pt100/Pt1000, three-wire) *2	0.1°C max.	Refer to your OMRON website for details.	250 ms/Unit	Free-Run refreshing	16 Terminals	NX-TS2201
	4 points		16 Terminals X 2				NX-TS3201	
	2 points		0.01°C max.		10 ms/Unit		16 Terminals	NX-TS2202
	4 points						16 Terminals X 2	NX-TS3202
	2 points		0.001°C max.		60 ms/Unit		16 Terminals	NX-TS2204
	4 points						16 Terminals X 2	NX-TS3204

*1. The resolution is 0.2°C max. when the input type is R, S, or W.
 *2. The NX-TS2202 and NX-TS3202 only support Pt100 three-wire sensor.

● Heater Burnout Detection Units

Product name	Specification							Model
	CT input section		Control output section					
	Number of inputs	Maximum heater current	Number of outputs	Internal I/O common	Maximum load current	Rated voltage	I/O refreshing method	
Heater Burnout Detection Unit 	4	50 A AC	4	NPN	0.1 A/point, 0.4 A/Unit	12 to 24 VDC	Free-Run refreshing	NX-HB3101
				PNP		24 VDC		NX-HB3201

● Optional Products

Product name	Specification	Model
Unit/Terminal Block Coding Pins	Pins for 10 Units (30 terminal block pins and 30 Unit pins)	NX-AUX02

Product name	Specification	Model
Current Transformer (CT)	Hole diameter: 5.8 mm	E54-CT1
	Hole diameter: 5.8 mm	E54-CT1L *
	Hole diameter: 12.0 mm	E54-CT3
	Hole diameter: 12.0 mm	E54-CT3L *

* Lead wires are included with these CTs. If UL certification is required, use these CTs.

Load Cell Input Unit

Product name	Specification					Model
	Number of points	Conversion cycle	I/O refreshing method *	Load cell excitation voltage	Input range	
 Load Cell Input Unit	1	125 μs	<ul style="list-style-type: none"> Free-Run refreshing Synchronous I/O refreshing Task period prioritized refreshing 	5 VDC ± 10%	-5.0 to 5.0 mV/V	NX-RS1201

* Refer to the *I/O Refreshing in the NX-series Load Cell Input Unit User's Manual* (Cat. No. W565) for detailed information on I/O refresh cycle.
Note: The NX-RS1201-K Load Cell Input Unit with the test and calibration certificate is also available. Ask your OMRON representative for details.

Position Interface Units: Incremental Encoder Input Units

Product name	Specification						Model
	Number of channels	External inputs	Maximum response frequency	I/O refreshing method	Number of I/O entry mappings	Remarks	
 Incremental Encoder Input Unit	1 (NPN)	3 (NPN)	500 kHz	<ul style="list-style-type: none"> Free-Run refreshing Synchronous I/O refreshing 	1/1	24-V voltage input	NX-EC0112
	1 (PNP)	3 (PNP)					NX-EC0122
	1	3 (NPN) 3 (PNP)	4 MHz			Line receiver input	NX-EC0132 NX-EC0142
	2 (NPN)	None	500 kHz		2/2	24-V voltage input	NX-EC0212
	2 (PNP)						NX-EC0222

Position Interface Units: SSI Input Units

Product name	Specification					Model
	Number of channels	Input/Output form	Maximum data length	Encoder power supply	Type of external connections	
 SSI Input Unit	1	EIA standard RS-422-A	32 bits	24 VDC, 0.3 A/CH	Screwless push-in terminal block (12 terminals)	NX-ECS112
	2	EIA standard RS-422-A	32 bits	24 VDC, 0.3 A/CH	Screwless push-in terminal block (12 terminals)	NX-ECS212







Position Interface Units: Pulse Output Units

Product name	Specification							Model	
	Number of channels *1	External inputs	External outputs	Maximum pulse output speed	I/O refreshing method	Number of I/O entry mappings	Control output interface		
 Pulse Output Unit	1 (NPN)	2 (NPN)	1 (NPN)	500 kpps	<ul style="list-style-type: none"> Synchronous I/O refreshing Task period prioritized refreshing *2 	1/1	Open collector output	NX-PG0112	
	1 (PNP)	2 (PNP)	1 (PNP)					NX-PG0122	
	2	5 inputs/CH (NPN)	3 outputs/CH (NPN)	4 Mpps		2/2	Line driver output	NX-PG0232-5	
		5 inputs/CH (PNP)	3 outputs/CH (PNP)					NX-PG0242-5	
	4	5 inputs/CH (NPN)	3 outputs/CH (NPN)			4/4		4/4	NX-PG0332-5
		5 inputs/CH (PNP)	3 outputs/CH (PNP)						NX-PG0342-5

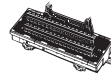
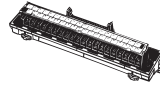
*1. This is the number of pulse output channels.

*2. Unit version 1.2 or later and an NX-ECC203 EtherCAT Coupler Unit are required.

Cables and Connectors for Line Driver Output Units with MIL Connectors

Product name	Specifications		Model	
Connector-Terminal Block Conversion Unit	Flat Cable Connectors type (Terminal block with M3 screws) 34 terminals		XW2B-34G4	
	Flat Cable Connectors type (Terminal block with M3.5 screws) 34 terminals		XW2B-34G5	
	MIL Connectors type (Slim Connector) 34 terminals		XW2D-34G6	
	MIL Connectors type (Phillips screw) 34 terminals		XW2R-J34GD-T	
	MIL Connectors type (Slotted screw (rise up)) 34 terminals		XW2R-E34GD-T	
	MIL Connectors type (Push-in spring) 34 terminals		XW2R-P34GD-T	
Cable for Connector-Terminal Block Conversion Unit	34-terminal MIL Connector to 34-terminal MIL Connector		Cable length: 0.5 m	XW2Z-050EE
			Cable length: 1 m	XW2Z-100EE
			Cable length: 1.5 m	XW2Z-150EE
			Cable length: 2 m	XW2Z-200EE
			Cable length: 3 m	XW2Z-300EE
			Cable length: 5 m	XW2Z-500EE

Note: Each of NX-PG0232-5 and NX-PG0242-5 has one MIL connector. Therefore, one Connector-Terminal Block Conversion Unit is required.
 Each of NX-PG0332-5 and NX-PG0342-5 has two MIL connectors. Therefore, two Connector-Terminal Block Conversion Units are required.

Communications Interface Units

Product name	Serial interface	External connection terminals	Number of serial ports	Communications function	Model
Communications Interface Unit 	RS-232C	Screwless clamping terminal block	1 port	<ul style="list-style-type: none"> No-protocol serial communications Serial line monitor 	NX-CIF101
	RS-422A/485				NX-CIF105
	RS-232C	D-Sub connector	2 ports		NX-CIF210

RFID Units

Product name	Amplifier/Antenna	No. of unit numbers used	Model
RFID Unit (1Ch) 	V680 series	1	NX-V680C1
RFID Unit (2Ch) 		2	NX-V680C2

IO-Link Master Unit

Product name	Specification			Model
	Number of IO-Link ports	I/O refreshing method	I/O connection terminals	
IO-Link Master Unit 	4	Free-Run refreshing	Screwless clamping terminal block	NX-ILM400

Note: For details of IO-Link sensors and sensor I/O connectors, refer to the *IO-Link Series Catalog* (Cat. No. Y229).

System Units

Product Name	Specifications	Model
Additional NX Unit Power Supply Unit 	Power supply voltage: 24 VDC (20.4 to 28.8 VDC) NX Bus power supply capacity: 10 W max.	NX-PD1000
Additional I/O Power Supply Unit 	Power supply voltage: 5 to 24 VDC (4.5 to 28.8 VDC) I/O power feed maximum current: 4 A	NX-PF0630
	Power supply voltage: 5 to 24 VDC (4.5 to 28.8 VDC) I/O power feed maximum current: 10 A	NX-PF0730
I/O Power Supply Connection Unit 	Number of I/O power terminals: IOG: 16 terminals Current capacity of I/O power terminal: 4 A/terminal max.	NX-PC0010
	Number of I/O power terminals: IOV: 16 terminals Current capacity of I/O power terminal: 4 A/terminal max.	NX-PC0020
	Number of I/O power terminals: IOV: 8 terminals, IOG: 8 terminals Current capacity of I/O power terminal: 4 A/terminal max	NX-PC0030
Shield Connection Unit 	Number of shield terminals: 14 terminals (The lower two terminals are functional ground terminals.)	NX-TBX01

Optional Products and Maintenance Products



Product name	Specification	Model
Unit/Terminal Block Coding Pins	For 10 Units (Terminal Block: 30 pins, Unit: 30 pins)	NX-AUX02
End Cover	One End Cover is provided as a standard accessory with the Communication Coupler Unit.	NX-END01
DIN Track Insulation Spacer	A Spacer to insulate the control panel from the DIN Track. To insulate the Slave Terminal from the control panel, use Din Track Insulation Spacers.	NX-AUX01

Product name	Specification				Model
	No. of terminals	Terminal number indications	Ground terminal mark	Terminal current capacity	
Terminal Block	8	A/B	None	10 A	NX-TBA082
	12	A/B			NX-TBA122
	16	A/B			NX-TBA162
	12	C/D			NX-TBB122
	16	C/D	NX-TBB162		
	8	A/B	Provided	NX-TBC082	
	16	A/B		NX-TBC162	

Safety Control Units **NX Series**



Ordering Information

Safety CPU Units

Unit type	Appearance	Specification					Model
		Maximum number of safety I/O points	Program capacity	Number of safety master connections	I/O refreshing method	Unit version	
Safety CPU Unit		256 points	512 KB	32	Free-Run refreshing	Ver.1.1	NX-SL3300
		1024 points	2048 KB	128	Free-Run refreshing	Ver.1.1	NX-SL3500



Note: Connect the Safety CPU Unit to the NX1P2 CPU Unit via the EtherCAT Coupler Unit.

Safety Input Units

Unit type	Appearance	Specification								Model
		Number of safety input points	Number of test output points	Internal I/O common	Rated input voltage	OMRON special safety input devices	Number of safety slave connections	I/O refreshing method	Unit version	
Safety Input Unit		4 points	2 points	Sinking inputs (PNP)	24 VDC	Can be connected.	1	Free-Run refreshing	Ver.1.1	NX-SIH400
		8 points	2 points	Sinking inputs (PNP)	24 VDC	Cannot be connected.	1	Free-Run refreshing	Ver.1.0	NX-SID800

Note: Connect the Safety Input Unit to the NX1P2 CPU Unit via the EtherCAT Coupler Unit.

Safety Output Units

Unit type	Appearance	Specification							Model
		Number of safety output points	Internal I/O common	Maximum load current	Rated voltage	Number of safety slave connections	I/O refreshing method	Unit version	
Safety Output Unit		2 points	Sourcing outputs (PNP)	2.0 A/point, 4.0 A/Unit at 40°C, and 2.5 A/Unit at 55°C The maximum load current depends on the installation orientation and ambient temperature.	24 VDC	1	Free-Run refreshing	Ver.1.0	NX-SOH200
		4 points	Sourcing outputs (PNP)	0.5 A/point and 2.0 A/Unit	24 VDC	1	Free-Run refreshing	Ver.1.0	NX-SOD400

Note: Connect the Safety Output Unit to the NX1P2 CPU Unit via the EtherCAT Coupler Unit.

Optional Products

Product Name	Specification				Model
Unit/Terminal Block Coding Pins	For 10 Units (Terminal Block: 30 pins, Unit: 30 pins)				NX-AUX02
Product name	Specification				Model
	No. of terminals	Terminal number indications	Ground terminal mark	Terminal current capacity	
Terminal Block	8	A/B	None	10 A	NX-TBA082
	16	A/B	None	10 A	NX-TBA162

Terms and Conditions Agreement

Read and understand this catalog.

Please read and understand this catalog before purchasing the products. Please consult your OMRON representative if you have any questions or comments.

Warranties.

- (a) Exclusive Warranty. Omron's exclusive warranty is that the Products will be free from defects in materials and workmanship for a period of twelve months from the date of sale by Omron (or such other period expressed in writing by Omron). Omron disclaims all other warranties, express or implied.
- (b) Limitations. OMRON MAKES NO WARRANTY OR REPRESENTATION, EXPRESS OR IMPLIED, ABOUT NON-INFRINGEMENT, MERCHANTABILITY OR FITNESS FOR A PARTICULAR PURPOSE OF THE PRODUCTS. BUYER ACKNOWLEDGES THAT IT ALONE HAS DETERMINED THAT THE PRODUCTS WILL SUITABLY MEET THE REQUIREMENTS OF THEIR INTENDED USE.

Omron further disclaims all warranties and responsibility of any type for claims or expenses based on infringement by the Products or otherwise of any intellectual property right. (c) Buyer Remedy. Omron's sole obligation hereunder shall be, at Omron's election, to (i) replace (in the form originally shipped with Buyer responsible for labor charges for removal or replacement thereof) the non-complying Product, (ii) repair the non-complying Product, or (iii) repay or credit Buyer an amount equal to the purchase price of the non-complying Product; provided that in no event shall Omron be responsible for warranty, repair, indemnity or any other claims or expenses regarding the Products unless Omron's analysis confirms that the Products were properly handled, stored, installed and maintained and not subject to contamination, abuse, misuse or inappropriate modification. Return of any Products by Buyer must be approved in writing by Omron before shipment. Omron Companies shall not be liable for the suitability or unsuitability or the results from the use of Products in combination with any electrical or electronic components, circuits, system assemblies or any other materials or substances or environments. Any advice, recommendations or information given orally or in writing, are not to be construed as an amendment or addition to the above warranty.

See <http://www.omron.com/global/> or contact your Omron representative for published information.

Limitation on Liability; Etc.

OMRON COMPANIES SHALL NOT BE LIABLE FOR SPECIAL, INDIRECT, INCIDENTAL, OR CONSEQUENTIAL DAMAGES, LOSS OF PROFITS OR PRODUCTION OR COMMERCIAL LOSS IN ANY WAY CONNECTED WITH THE PRODUCTS, WHETHER SUCH CLAIM IS BASED IN CONTRACT, WARRANTY, NEGLIGENCE OR STRICT LIABILITY.

Further, in no event shall liability of Omron Companies exceed the individual price of the Product on which liability is asserted.

Suitability of Use.

Omron Companies shall not be responsible for conformity with any standards, codes or regulations which apply to the combination of the Product in the Buyer's application or use of the Product. At Buyer's request, Omron will provide applicable third party certification documents identifying ratings and limitations of use which apply to the Product. This information by itself is not sufficient for a complete determination of the suitability of the Product in combination with the end product, machine, system, or other application or use. Buyer shall be solely responsible for determining appropriateness of the particular Product with respect to Buyer's application, product or system. Buyer shall take application responsibility in all cases.

NEVER USE THE PRODUCT FOR AN APPLICATION INVOLVING SERIOUS RISK TO LIFE OR PROPERTY OR IN LARGE QUANTITIES WITHOUT ENSURING THAT THE SYSTEM AS A WHOLE HAS BEEN DESIGNED TO ADDRESS THE RISKS, AND THAT THE OMRON PRODUCT(S) IS PROPERLY RATED AND INSTALLED FOR THE INTENDED USE WITHIN THE OVERALL EQUIPMENT OR SYSTEM.

Programmable Products.

Omron Companies shall not be responsible for the user's programming of a programmable Product, or any consequence thereof.

Performance Data.

Data presented in Omron Company websites, catalogs and other materials is provided as a guide for the user in determining suitability and does not constitute a warranty. It may represent the result of Omron's test conditions, and the user must correlate it to actual application requirements. Actual performance is subject to the Omron's Warranty and Limitations of Liability.

Change in Specifications.

Product specifications and accessories may be changed at any time based on improvements and other reasons. It is our practice to change part numbers when published ratings or features are changed, or when significant construction changes are made. However, some specifications of the Product may be changed without any notice. When in doubt, special part numbers may be assigned to fix or establish key specifications for your application. Please consult with your Omron's representative at any time to confirm actual specifications of purchased Product.

Errors and Omissions.

Information presented by Omron Companies has been checked and is believed to be accurate; however, no responsibility is assumed for clerical, typographical or proofreading errors or omissions.

OMRON Corporation Industrial Automation Company
Kyoto, JAPAN

Contact: www.ia.omron.com

Regional Headquarters

OMRON EUROPE B.V.
Wegalaan 67-69, 2132 JD Hoofddorp
The Netherlands
Tel: (31)2356-81-300/Fax: (31)2356-81-388

OMRON ELECTRONICS LLC
2895 Greenspoint Parkway, Suite 200
Hoffman Estates, IL 60169 U.S.A.
Tel: (1) 847-843-7900/Fax: (1) 847-843-7787

OMRON ASIA PACIFIC PTE. LTD.
No. 438A Alexandra Road # 05-05/08 (Lobby 2),
Alexandra Technopark,
Singapore 119967
Tel: (65) 6835-3011/Fax: (65) 6835-2711

OMRON (CHINA) CO., LTD.
Room 2211, Bank of China Tower,
200 Yin Cheng Zhong Road,
PuDong New Area, Shanghai, 200120, China
Tel: (86) 21-5037-2222/Fax: (86) 21-5037-2200

Authorized Distributor:

© OMRON Corporation 2014-2018 All Rights Reserved.
In the interest of product improvement,
specifications are subject to change without notice.

CSM_7_8_0319
Cat. No. R183-E1-09

1018(1214)