

NEW

OMRON

Safety Light Curtain

MS4800 Series



Strong, Durable Body and Long,
20-m Sensing Distance

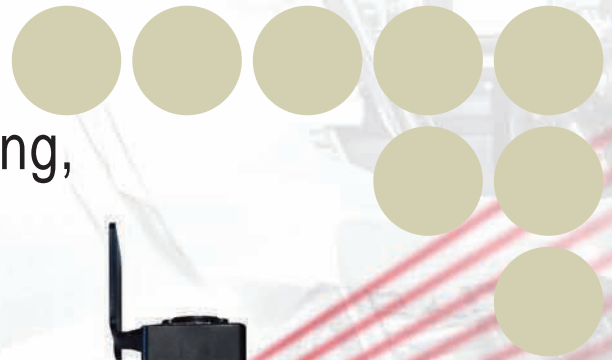

realizing



A Powerful Safety Light Curtain with Durable, Impact-resistant Body and Long, 20-m Sensing Distance Has Arrived.

OMRON Safety Light Curtains continue to evolve through innovation. The MS4800 Series now joins the lineup with a host of important features. Hardware aspects include a tough, durable body, a long sensing distance of up to 20 m, and a Programming and Diagnostics Module for flexible production line adaptability. Software provides a wide range of functions, such as blanking and muting.

The MS4800 Series offers powerful performance in virtually every production situation, meeting the needs of every application.

Apply the MS4800 Series to the safety protection applications that you've always wanted, but were never before possible.

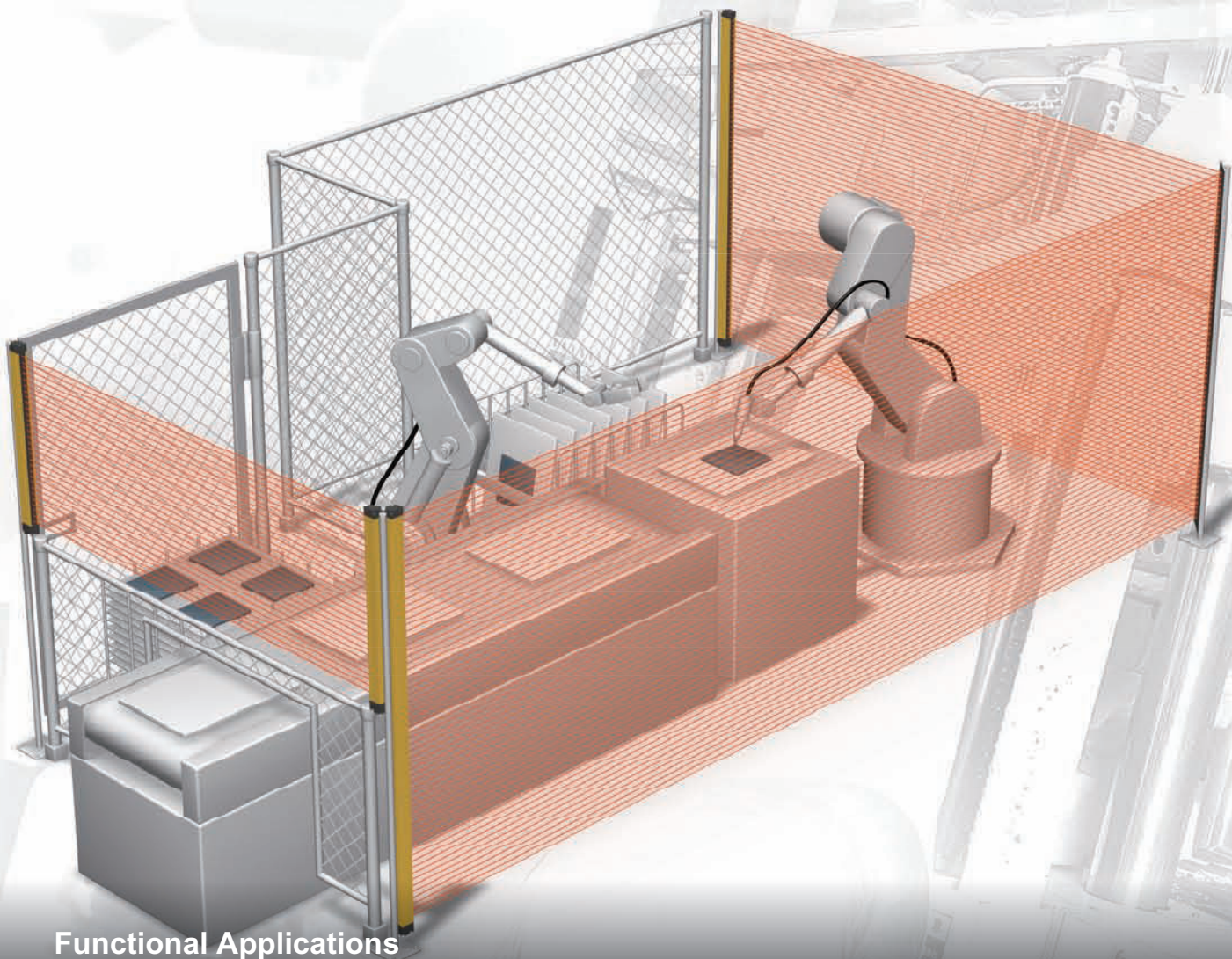

Functional Applications

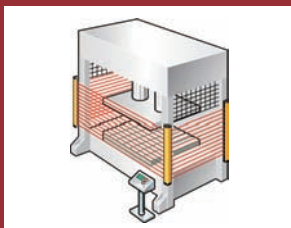

Three-sided Guard

The durable housing of the MS4800 Series makes it ideal for applications with strong vibration, like metal processing systems. Its sensing distance of up to 20 m also lets you use mirrors to guard three sides with a single MS4800 system.



Muting

(MSF4800A only)
Combining the MSF4800A and the MS4800-RM6 Muting Module lets you set muting without having to use an external controller.

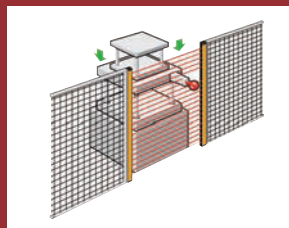

Floating Blanking

(Advanced series only)
Floating blanking can be set for one or two beams. When the number of set beams are interrupted, the output is turned OFF.



Reduced Resolution Blanking

(Advanced series only)
Reducing the detection resolution of the MS/MSF4800A Safety Light Curtain increases the size of the smallest detectable object. This can improve productivity by allowing objects such as carts to enter the sensing area.

Safety Light Curtain MS4800

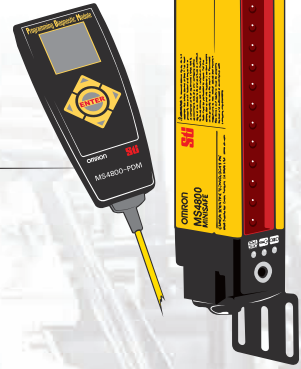

Durable Housing with a Thickness of 3 mm Min. Withstands Vibration and Impacts

Unlike conventional Safety Light Curtains, the MS4800 Series uses a thick aluminum case (3 mm at its thinnest parts). This makes it ideal for applications with considerable vibration or impacts.

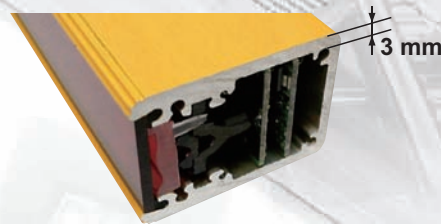

Long Maximum Sensing Distance of 20 m

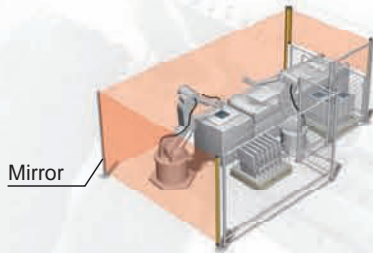

The long, 20-m maximum sensing distance of the MS4800 Series marks the highest level in the industry. Even in applications where large, complicated machines are guarded, the use of mirrors can reduce the number of Safety Light Curtains required.

A Wide Lineup for a Variety of Applications

Two series are available to meet your needs: the Advanced Series with sophisticated functions and the Basic Series with specialized, basic functions.

	Minimum detectable object	Beam gap	Protective height
Advanced Series MS/MSF4800A	30-mm diameter	20 mm	280 to 2,120 mm
	40-mm diameter	30 mm	360 to 2,040 mm
Basic Series MS/MSF4800B	30-mm diameter	20 mm	280 to 2,120 mm
	40-mm diameter	30 mm	360 to 2,040 mm

Series Connection of Up to Four Systems with No Controller Necessary (Allowing a total of 256 beams max.) (MSF4800 only)

Up to four systems can be connected in series (for a total of 256 beams) without having to connect a controller. Models for which the smallest detectable object is different can even be connected to respond flexibly to virtually any application.

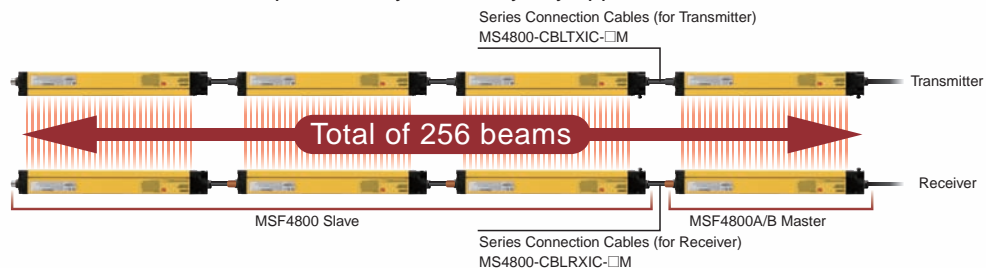

OMRON STI's Unique Individual Beam Indicators Combine with the LCD-equipped Programming and Diagnostics Module to Simplify Function Setting and Beam Adjustment.

The Programming and Diagnostics Module provides for easy, intuitive operation with a host of advanced functions and English/Japanese language selection. This advanced Safety Light Curtain makes it possible to visualize safety with its easy-to-see indicators. Plus, its many functions allow it to adapt to virtually any application.

Intuitive Operation with the Programming and Diagnostics Module (PDM)

Complete with an LCD that displays in either English or Japanese, the PDM makes it easy and intuitive to program, change settings, and troubleshoot the MS4800 Series.

- Easy operation with five function buttons.
- Allows setting changes and status monitoring.
- IP65 protection.
- Safety outputs operate while the PDM is connected, making it possible to monitor during operation.

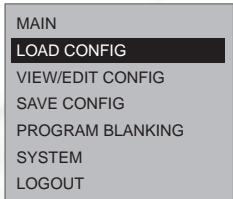

The interactive menu simplifies operation. (The Safety Light Curtain settings must be loaded in advance.)



Connect to the PDM connection port at the bottom of the Safety Light Curtain. Power is supplied from the Safety Light Curtain.



Easy-to-understand Individual Beam Indicators (IBI)

The MS4800-series Receiver is equipped with OMRON STI's unique Individual Beam Indicator (IBI) function. When a beam is interrupted, or when it is out of alignment, an individual LED lights at each corresponding Receiver beam position to notify the operator. This makes it easy to align beams even from a distance. An error code is also displayed when an error occurs. (This function is provided only on the Receiver.)

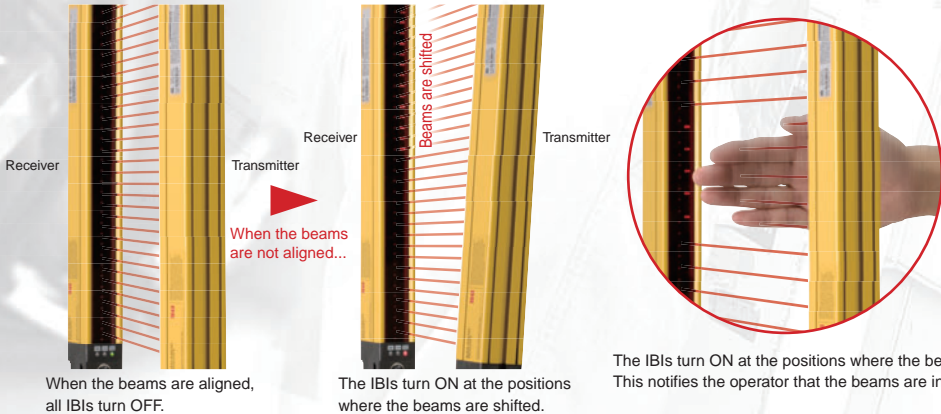

Safety Light Curtain MS4800

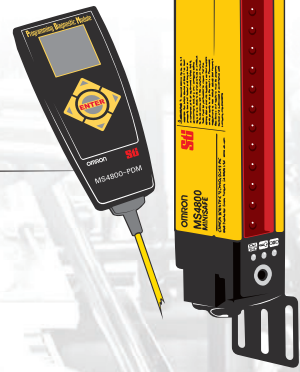

Four Blanking Functions for Disabling Beams

(Advanced series only)

When a machine or a workpiece is present inside the sensing area of the Safety Light Curtain, the output turns OFF and the machine cannot be started. However, a blanking function can be used to disable the appropriate beams of the Safety Light Curtain and allow work to continue without stopping the machine. The MS4800 Series provides four blanking functions to combine both safety and productivity in a wide range of applications.

Fixed Blanking

This function is used when a machine or workpiece constantly interrupts beams in a part of the sensing area. Fixed Blanking allows the Safety Light Curtain to remain in the RUN state while the obstruction is fixed (as a non-moving object) within the sensing area. The output is turned OFF when a beam other than the set fixed blanking beams is interrupted, or when light is incident on a fixed blanking beam.

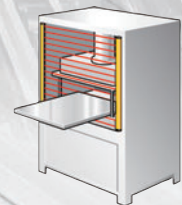

Fixed Blanking

Floating Blanking

This function turns OFF the output when the total number of interrupted beams inside the sensing area exceeds the number of set beams (1 or 2).

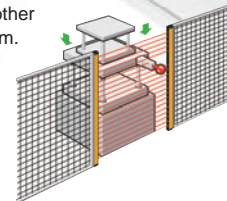

Floating Blanking

Monitored Blanking

This function is used when a machine or workpiece constantly interrupts beams in a part of the sensing area and moves within the sensing area. Monitored Blanking allows the Safety Light Curtain to remain in the RUN state while the obstruction moves within the sensing area. The output is turned OFF when the machine or workpiece disappears from the monitored blanking area that was set by teaching, or when the total number of interrupted beams increases due to a different obstruction.

Reduced Resolution Blanking

When the resolution of the MS/MSF4800A is reduced, the size of the smallest detectable object is increased. The output will not turn OFF regardless of how many continuous interrupted beams there are in the sensing area as long as the beams are fewer than the set number (1, 2, or 3 beams). When an object whose size exceeds the set number of beams intrudes, the output is turned OFF. For example, in an application where a conveyor cart approaches a robot work area, the Safety Light Curtain can be set so that it does not detect only the wheels of the cart, allowing the MS/MSF4800A to be used as a presence sensing device.

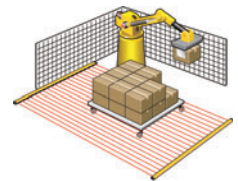

Reduced Resolution Blanking

Muting Functions for Temporarily Disabling the Safety Light Curtain (MSF4800A only)

In applications where it is necessary for an object to regularly pass through the sensing area, for example to supply workpieces to a machine, the output will turn OFF each time the object passes through, thus lowering productivity. The muting function makes it possible to raise productivity in this kind of application by temporarily disabling the Safety Light Curtain.

Select from among four muting modes to match each application with the appropriate number and placement of muting sensors.



The MS4800-RM6 Resource Module is required when using the muting function.

Complies with the Newest Global Safety Standards

The MS4800-series Safety Light Curtains comply with ISO 13849-1 (Safety Category 4, PlE). They are Type 4 safety light curtains under the IEC 61496-1 and IEC 61496-2 international standards for safety light curtains. They also comply with the IEC 61508 (SIL3) international standard for function safety. These standards ensure safe, reliable use virtually anywhere.



Safety Light Curtain

MS4800 Series

Safety Light Curtains with Durable, Impact-resistant Body and Long, 20-m Sensing Distance

MS/MSF4800A Advanced Series

- Programming and Diagnostics Module (PDM) makes it easy to set functions.
- Series connection is possible only with the MSF4800A.
- Blanking can be set.
- Muting is possible only with the MSF4800A by using the MS4800-RM6 Resource Module.

MS/MSF4800B Basic Series

- Features all necessary basic Safety Light Curtain functions.
- Series connection is possible only with the MSF4800B.
- Programming and Diagnostics Module (PDM) makes it easy to set functions.



Be sure to read the *Precautions for Safe Use* on page 31.

Features

Durable Housing Withstands Vibration and Impacts

MS4800 Safety Light Curtains have a thick aluminum case (3 mm at its thinnest parts). This makes them ideal for applications with considerable vibration or impacts.

Long-distance Sensing

The maximum sensing distance is 20 meters. This makes the MS4800 Safety Light Curtain well suited to peripheral guard applications using mirrors.

Select the Minimum Detectable Object Size and Protective Height to Match the Application

The minimum detectable object size can be selected as either 30 mm or 40 mm in diameter.

When the 30-mm size is selected, the protective height can be from 280 mm to 2,120 mm.

When the 40-mm size is selected, the protective height can be from 360 mm to 2,040 mm.

Individual Beam Indicators (IBI)

When the infrared beams are interrupted or when the beams are not correctly aligned, Individual Beam Indicators on the Receiver light. This makes it easy to align beams even from a distance.

Series Connection Function (MSF4800 Only)

Up to four MSF4800 Safety Light Curtains can be “daisy-chained” in series. When using this configuration, the total

number of beams must not exceed 256. Each MSF4800 in the configuration is called a segment. The segment connected to the control system and power supply is called the master segment, and the other segments are called slave segments. There must be one master segment. When connecting two segments, use one master segment and one slave segment. For three segments, use one master segment and two slave segments; and for four segments, use one master segment and three slave segments.

Note: A slave segment cannot be used alone.

No Special Controller

A Category 4 safety circuit can be configured using only Receivers and Transmitters.

Test Input (MTS)

This function lets you use an external signal to halt the light emission of the Safety Light Curtain to check the operation of the safety system when the Safety Light Curtain is interrupted.

External Device Monitoring (EDM, MPCE Monitoring)

This function detects operating faults such as contact welding of the external device (relay) that is used to control a machine.

Scan Code for Mutual Interference Reduction

Switching the two types of scan codes helps to reduce mutual interference between adjacent Safety Light Curtains.

Complies with the Newest Global Safety Standards

Ordering Information

Safety Light Curtains

MS/MSF4800-series Safety Light Curtains

 Infrared light

Series	Minimum detectable object	Beam gap	Appearance	Sensing distance			Number of beams	Protective height (mm)	Model			
									Individual use	Series connection (for muting *1)		
Advanced Series	30-mm-dia.	20 mm		0.3 to 20 m				MS4800A-30-□	Master	MSF4800A-30-□		
									Slave *2	MSF4800-30-□ -XR2		
	40-mm-dia.	30 mm						12 to 68	360 to 2040	MS4800A-40-□	Master	MSF4800A-40-□
											Slave *2	MSF4800-40-□ -XR2
Basic Series	30-mm-dia.	20 mm					MS4800B-30-□	Master	MSF4800B-30-□			
								Slave *2	MSF4800-30-□ -XR2			
	40-mm-dia.	30 mm					12 to 68	360 to 2040	MS4800B-40-□	Master	MSF4800B-40-□	
										Slave *2	MSF4800-40-□ -XR2	

Note: A 4-digit number indicating the protective height of the Light Curtain must be included in place of the box (□) in the model number.

*1. There is no muting function in Basic-series Safety Light Curtains.

*2. The same Slave Light Curtains are used for both the Advanced Series and Basic Series. These Slaves cannot be used individually.

Functional Comparison of Advanced Series and Basic Series

Function	Series	Advanced Series	Basic Series
	Model	MS/MSF4800A	MS/MSF4800B
Scan code for mutual interference reduction		Supported. *1	Supported. *1
External device monitoring (EDM)		Supported. *2	Supported. *2
Operation mode		Supported. *1	Supported. *1
Machine test signal (MTS)		Supported. *1	Supported. *1
Auxiliary output (PNP transistor × 1, or NPN transistor × 1)		Supported. *1	Supported. (PNP/control output synchronizing only)
Muting via the MS4800-RM6 Resource Module		Supported. *1 (MSF4800A only)	
Floating blanking		Supported. *1	
Fixed blanking		Supported. *1	
Monitored blanking		Supported. *1	
Reduced resolution blanking		Supported. *1	
Sensing distance setting		Supported. *1	Supported. *1
Start input method		Supported. *1	
Response time adjustment		Supported. *1	

*1. This function can be set by using the Programming and Diagnostics Module (PDM).

*2. This function can be set by using the PDM or a wiring connection.

Safety Light Curtain Model List

Advanced-series Curtains Used Individually
(Minimum detectable object: 30-mm dia., Beam gap: 20 mm)

Model	Number of beams	Protective height (mm)
MS4800A-30-0280	14	280
MS4800A-30-0320	16	320
MS4800A-30-0360	18	360
MS4800A-30-0400	20	400
MS4800A-30-0440	22	440
MS4800A-30-0480	24	480
MS4800A-30-0520	26	520
MS4800A-30-0560	28	560
MS4800A-30-0600	30	600
MS4800A-30-0640	32	640
MS4800A-30-0680	34	680
MS4800A-30-0720	36	720
MS4800A-30-0760	38	760
MS4800A-30-0800	40	800
MS4800A-30-0840	42	840
MS4800A-30-0880	44	880
MS4800A-30-0920	46	920
MS4800A-30-0960	48	960
MS4800A-30-1000	50	1000
MS4800A-30-1040	52	1040
MS4800A-30-1080	54	1080
MS4800A-30-1120	56	1120
MS4800A-30-1160	58	1160
MS4800A-30-1200	60	1200
MS4800A-30-1240	62	1240
MS4800A-30-1280	64	1280
MS4800A-30-1320	66	1320
MS4800A-30-1360	68	1360
MS4800A-30-1400	70	1400
MS4800A-30-1440	72	1440
MS4800A-30-1480	74	1480
MS4800A-30-1520	76	1520
MS4800A-30-1560	78	1560
MS4800A-30-1600	80	1600
MS4800A-30-1640	82	1640
MS4800A-30-1680	84	1680
MS4800A-30-1720	86	1720
MS4800A-30-1760	88	1760
MS4800A-30-1800	90	1800
MS4800A-30-1840	92	1840
MS4800A-30-1880	94	1880
MS4800A-30-1920	96	1920
MS4800A-30-1960	98	1960
MS4800A-30-2000	100	2000
MS4800A-30-2040	102	2040
MS4800A-30-2080	104	2080
MS4800A-30-2120	106	2120

Advanced-series Curtains Used Individually
(Minimum detectable object: 40-mm dia., Beam gap: 30 mm)

Model	Number of beams	Protective height (mm)
MS4800A-40-0360	12	360
MS4800A-40-0480	16	480
MS4800A-40-0600	20	600
MS4800A-40-0720	24	720
MS4800A-40-0840	28	840
MS4800A-40-0960	32	960
MS4800A-40-1080	36	1080
MS4800A-40-1200	40	1200
MS4800A-40-1320	44	1320
MS4800A-40-1440	48	1440
MS4800A-40-1560	52	1560
MS4800A-40-1680	56	1680
MS4800A-40-1800	60	1800
MS4800A-40-1920	64	1920
MS4800A-40-2040	68	2040

Basic-series Curtains Used Individually
(Minimum detectable object: 30-mm dia., Beam gap: 20 mm)

Model	Number of beams	Protective height (mm)
MS4800B-30-0280	14	280
MS4800B-30-0320	16	320
MS4800B-30-0360	18	360
MS4800B-30-0400	20	400
MS4800B-30-0440	22	440
MS4800B-30-0480	24	480
MS4800B-30-0520	26	520
MS4800B-30-0560	28	560
MS4800B-30-0600	30	600
MS4800B-30-0640	32	640
MS4800B-30-0680	34	680
MS4800B-30-0720	36	720
MS4800B-30-0760	38	760
MS4800B-30-0800	40	800
MS4800B-30-0840	42	840
MS4800B-30-0880	44	880
MS4800B-30-0920	46	920
MS4800B-30-0960	48	960
MS4800B-30-1000	50	1000
MS4800B-30-1040	52	1040
MS4800B-30-1080	54	1080
MS4800B-30-1120	56	1120
MS4800B-30-1160	58	1160
MS4800B-30-1200	60	1200
MS4800B-30-1240	62	1240
MS4800B-30-1280	64	1280
MS4800B-30-1320	66	1320
MS4800B-30-1360	68	1360
MS4800B-30-1400	70	1400
MS4800B-30-1440	72	1440
MS4800B-30-1480	74	1480
MS4800B-30-1520	76	1520
MS4800B-30-1560	78	1560
MS4800B-30-1600	80	1600
MS4800B-30-1640	82	1640
MS4800B-30-1680	84	1680
MS4800B-30-1720	86	1720
MS4800B-30-1760	88	1760
MS4800B-30-1800	90	1800
MS4800B-30-1840	92	1840
MS4800B-30-1880	94	1880
MS4800B-30-1920	96	1920
MS4800B-30-1960	98	1960
MS4800B-30-2000	100	2000
MS4800B-30-2040	102	2040
MS4800B-30-2080	104	2080
MS4800B-30-2120	106	2120

Basic-series Curtains Used Individually
(Minimum detectable object: 40-mm dia., Beam gap: 30 mm)

Model	Number of beams	Protective height (mm)
MS4800B-40-0360	12	360
MS4800B-40-0480	16	480
MS4800B-40-0600	20	600
MS4800B-40-0720	24	720
MS4800B-40-0840	28	840
MS4800B-40-0960	32	960
MS4800B-40-1080	36	1080
MS4800B-40-1200	40	1200
MS4800B-40-1320	44	1320
MS4800B-40-1440	48	1440
MS4800B-40-1560	52	1560
MS4800B-40-1680	56	1680
MS4800B-40-1800	60	1800
MS4800B-40-1920	64	1920
MS4800B-40-2040	68	2040

Advanced-series Curtains Connected in Series
(Minimum detectable object: 30-mm dia., Beam gap: 20 mm)

Masters

Model	Number of beams	Protective height (mm)
MSF4800A-30-0280	14	280
MSF4800A-30-0320	16	320
MSF4800A-30-0360	18	360
MSF4800A-30-0400	20	400
MSF4800A-30-0440	22	440
MSF4800A-30-0480	24	480
MSF4800A-30-0520	26	520
MSF4800A-30-0560	28	560
MSF4800A-30-0600	30	600
MSF4800A-30-0640	32	640
MSF4800A-30-0680	34	680
MSF4800A-30-0720	36	720
MSF4800A-30-0760	38	760
MSF4800A-30-0800	40	800
MSF4800A-30-0840	42	840
MSF4800A-30-0880	44	880
MSF4800A-30-0920	46	920
MSF4800A-30-0960	48	960
MSF4800A-30-1000	50	1000
MSF4800A-30-1040	52	1040
MSF4800A-30-1080	54	1080
MSF4800A-30-1120	56	1120
MSF4800A-30-1160	58	1160
MSF4800A-30-1200	60	1200
MSF4800A-30-1240	62	1240
MSF4800A-30-1280	64	1280
MSF4800A-30-1320	66	1320
MSF4800A-30-1360	68	1360
MSF4800A-30-1400	70	1400
MSF4800A-30-1440	72	1440
MSF4800A-30-1480	74	1480
MSF4800A-30-1520	76	1520
MSF4800A-30-1560	78	1560
MSF4800A-30-1600	80	1600
MSF4800A-30-1640	82	1640
MSF4800A-30-1680	84	1680
MSF4800A-30-1720	86	1720
MSF4800A-30-1760	88	1760
MSF4800A-30-1800	90	1800
MSF4800A-30-1840	92	1840
MSF4800A-30-1880	94	1880
MSF4800A-30-1920	96	1920
MSF4800A-30-1960	98	1960
MSF4800A-30-2000	100	2000
MSF4800A-30-2040	102	2040
MSF4800A-30-2080	104	2080
MSF4800A-30-2120	106	2120

Advanced-series Curtains Connected in Series
(Minimum detectable object: 40-mm dia., Beam gap: 30 mm)

Masters

Model	Number of beams	Protective height (mm)
MSF4800A-40-0360	12	360
MSF4800A-40-0480	16	480
MSF4800A-40-0600	20	600
MSF4800A-40-0720	24	720
MSF4800A-40-0840	28	840
MSF4800A-40-0960	32	960
MSF4800A-40-1080	36	1080
MSF4800A-40-1200	40	1200
MSF4800A-40-1320	44	1320
MSF4800A-40-1440	48	1440
MSF4800A-40-1560	52	1560
MSF4800A-40-1680	56	1680
MSF4800A-40-1800	60	1800
MSF4800A-40-1920	64	1920
MSF4800A-40-2040	68	2040

Basic-series Curtains Connected in Series
(Minimum detectable object: 30-mm dia., Beam gap: 20 mm)

Masters

Model	Number of beams	Protective height (mm)
MSF4800B-30-0280	14	280
MSF4800B-30-0320	16	320
MSF4800B-30-0360	18	360
MSF4800B-30-0400	20	400
MSF4800B-30-0440	22	440
MSF4800B-30-0480	24	480
MSF4800B-30-0520	26	520
MSF4800B-30-0560	28	560
MSF4800B-30-0600	30	600
MSF4800B-30-0640	32	640
MSF4800B-30-0680	34	680
MSF4800B-30-0720	36	720
MSF4800B-30-0760	38	760
MSF4800B-30-0800	40	800
MSF4800B-30-0840	42	840
MSF4800B-30-0880	44	880
MSF4800B-30-0920	46	920
MSF4800B-30-0960	48	960
MSF4800B-30-1000	50	1000
MSF4800B-30-1040	52	1040
MSF4800B-30-1080	54	1080
MSF4800B-30-1120	56	1120
MSF4800B-30-1160	58	1160
MSF4800B-30-1200	60	1200
MSF4800B-30-1240	62	1240
MSF4800B-30-1280	64	1280
MSF4800B-30-1320	66	1320
MSF4800B-30-1360	68	1360
MSF4800B-30-1400	70	1400
MSF4800B-30-1440	72	1440
MSF4800B-30-1480	74	1480
MSF4800B-30-1520	76	1520
MSF4800B-30-1560	78	1560
MSF4800B-30-1600	80	1600
MSF4800B-30-1640	82	1640
MSF4800B-30-1680	84	1680
MSF4800B-30-1720	86	1720
MSF4800B-30-1760	88	1760
MSF4800B-30-1800	90	1800
MSF4800B-30-1840	92	1840
MSF4800B-30-1880	94	1880
MSF4800B-30-1920	96	1920
MSF4800B-30-1960	98	1960
MSF4800B-30-2000	100	2000
MSF4800B-30-2040	102	2040
MSF4800B-30-2080	104	2080
MSF4800B-30-2120	106	2120

Basic-series Curtains Connected in Series
(Minimum detectable object: 40-mm dia., Beam gap: 30 mm)

Masters

Model	Number of beams	Protective height (mm)
MSF4800B-40-0360	12	360
MSF4800B-40-0480	16	480
MSF4800B-40-0600	20	600
MSF4800B-40-0720	24	720
MSF4800B-40-0840	28	840
MSF4800B-40-0960	32	960
MSF4800B-40-1080	36	1080
MSF4800B-40-1200	40	1200
MSF4800B-40-1320	44	1320
MSF4800B-40-1440	48	1440
MSF4800B-40-1560	52	1560
MSF4800B-40-1680	56	1680
MSF4800B-40-1800	60	1800
MSF4800B-40-1920	64	1920
MSF4800B-40-2040	68	2040

Advanced Series/Basic-series Curtains Connected in Series
(Minimum detectable object: 30-mm dia., Beam gap: 20 mm)

Slaves

Model	Number of beams	Protective height (mm)
MSF4800-30-0280-XR2	14	280
MSF4800-30-0320-XR2	16	320
MSF4800-30-0360-XR2	18	360
MSF4800-30-0400-XR2	20	400
MSF4800-30-0440-XR2	22	440
MSF4800-30-0480-XR2	24	480
MSF4800-30-0520-XR2	26	520
MSF4800-30-0560-XR2	28	560
MSF4800-30-0600-XR2	30	600
MSF4800-30-0640-XR2	32	640
MSF4800-30-0680-XR2	34	680
MSF4800-30-0720-XR2	36	720
MSF4800-30-0760-XR2	38	760
MSF4800-30-0800-XR2	40	800
MSF4800-30-0840-XR2	42	840
MSF4800-30-0880-XR2	44	880
MSF4800-30-0920-XR2	46	920
MSF4800-30-0960-XR2	48	960
MSF4800-30-1000-XR2	50	1000
MSF4800-30-1040-XR2	52	1040
MSF4800-30-1080-XR2	54	1080
MSF4800-30-1120-XR2	56	1120
MSF4800-30-1160-XR2	58	1160
MSF4800-30-1200-XR2	60	1200
MSF4800-30-1240-XR2	62	1240
MSF4800-30-1280-XR2	64	1280
MSF4800-30-1320-XR2	66	1320
MSF4800-30-1360-XR2	68	1360
MSF4800-30-1400-XR2	70	1400
MSF4800-30-1440-XR2	72	1440
MSF4800-30-1480-XR2	74	1480
MSF4800-30-1520-XR2	76	1520
MSF4800-30-1560-XR2	78	1560
MSF4800-30-1600-XR2	80	1600
MSF4800-30-1640-XR2	82	1640
MSF4800-30-1680-XR2	84	1680
MSF4800-30-1720-XR2	86	1720
MSF4800-30-1760-XR2	88	1760
MSF4800-30-1800-XR2	90	1800
MSF4800-30-1840-XR2	92	1840
MSF4800-30-1880-XR2	94	1880
MSF4800-30-1920-XR2	96	1920
MSF4800-30-1960-XR2	98	1960
MSF4800-30-2000-XR2	100	2000
MSF4800-30-2040-XR2	102	2040
MSF4800-30-2080-XR2	104	2080
MSF4800-30-2120-XR2	106	2120



Advanced Series/Basic-series Curtains Connected in Series
(Minimum detectable object: 40-mm dia., Beam gap: 30 mm)

Slaves



Model	Number of beams	Protective height (mm)
MSF4800-40-0360-XR2	12	360
MSF4800-40-0480-XR2	16	480
MSF4800-40-0600-XR2	20	600
MSF4800-40-0720-XR2	24	720
MSF4800-40-0840-XR2	28	840
MSF4800-40-0960-XR2	32	960
MSF4800-40-1080-XR2	36	1080
MSF4800-40-1200-XR2	40	1200
MSF4800-40-1320-XR2	44	1320
MSF4800-40-1440-XR2	48	1440
MSF4800-40-1560-XR2	52	1560
MSF4800-40-1680-XR2	56	1680
MSF4800-40-1800-XR2	60	1800
MSF4800-40-1920-XR2	64	1920
MSF4800-40-2040-XR2	68	2040

Accessories (Sold Separately)



Connector Cables with a Connector on One End

Type	Appearance	Specifications	Cable length	Model	Application
Transmitter Cables		M12 connector (5-pin)	10 m	MS4800-CBLTX-10M	For wiring safety circuits containing individual relays with forcibly guided contacts, safety relay units, safety controllers, etc.
			15 m	MS4800-CBLTX-15M	
			30 m	MS4800-CBLTX-30M	
Receiver Cables		M12 connector (8-pin)	10 m	MS4800-CBLRX-10M	
			15 m	MS4800-CBLRX-15M	
			30 m	MS4800-CBLRX-30M	



Connector Cables with Connectors on Both Ends

Type	Appearance	Specifications	Cable length	Model	Application
Transmitter Cables		M12 connector (5-pin)	5 m	MS4800-CBLTXT-05M	Extension cables for connector cables with a connector on one end.
			10 m	MS4800-CBLTXT-10M	
			15 m	MS4800-CBLTXT-15M	
			25 m	MS4800-CBLTXT-25M	
Receiver Cables		M12 connector (8-pin)	5 m	MS4800-CBLRXT-05M	
			10 m	MS4800-CBLRXT-10M	
			15 m	MS4800-CBLRXT-15M	
			25 m	MS4800-CBLRXT-25M	



Series Connection Cables

Type	Appearance	Specifications	Cable length	Model	Application
Transmitter Cables		M12 connector (4-pin)	0.3 m	MS4800-CBLTXIC-003M	For series connection.
			0.5 m	MS4800-CBLTXIC-005M	
			1 m	MS4800-CBLTXIC-01M	
			2 m	MS4800-CBLTXIC-02M	
			3 m	MS4800-CBLTXIC-03M	
			5 m	MS4800-CBLTXIC-05M	
			10 m	MS4800-CBLTXIC-10M	
Receiver Cables		M12 connector (4-pin)	0.3 m	MS4800-CBLRXIC-003M	
			0.5 m	MS4800-CBLRXIC-005M	
			1 m	MS4800-CBLRXIC-01M	
			2 m	MS4800-CBLRXIC-02M	
			3 m	MS4800-CBLRXIC-03M	
			5 m	MS4800-CBLRXIC-05M	
			10 m	MS4800-CBLRXIC-10M	

Adaptor Cables for Replacement Use

Type	Appearance	Specifications	Cable length	Model	Application
Transmitter Cables		M12 connector (8-pin)	0.22 m	MS4800-ADPT-TXM	For replacing an MS4600 (with test input) with an MS4800.
		M12 connector (5-pin)	0.22 m	MS4800-ADPT-TXS	For replacing an F3SL or MS4600 (without test input) with an MS4800.
Receiver Cables		M12 connector (8-pin)	0.22 m	MS4800-ADPT-RX	For replacing an F3SL or MS4600 with an MS4800.

Loose-wire Connectors for Relays

Type	Appearance	Specifications	Cable length	Model	Application
Transmitter Cables		M12 connector (5-pin)	1 m	MS4800-PMCTX-01M	Loose-wire connectors for mounting in relay boxes.
			5 m	MS4800-PMCTX-05M	
Receiver Cables		M12 connector (8-pin)	1 m	MS4800-PMCRX-01M	
			5 m	MS4800-PMCRX-05M	

Programming and Diagnostics Module (PDM)

Appearance	Model	Remarks
	MS4800-PDM	Cable length: 2 m

Mirrors (12% Sensing Distance Attenuation)

Appearance	Mirror material	Width (mm)	Thickness (mm)	Length (mm)	Model	Remarks
	Glass mirror	145	32	406	F39-MLG0406	2 sets of Cylindrical mounting rod, 4 screws are included.
				610	F39-MLG0610	
				711	F39-MLG0711	
				914	F39-MLG0914	
				1,067	F39-MLG1067	
				1,219	F39-MLG1219	
				1,422	F39-MLG1422	
				1,626	F39-MLG1626	
				1,830	F39-MLG1830	
2,134	F39-MLG2134					

MS4800-RM6 Connection Cables

Appearance	Cable length	Model	Application
	10 m	MS4800-CBLMT-10M	For connecting an MSF4800A Receiver and an MS4800-RM6 Resource Module.
	15 m	MS4800-CBLMT-15M	
	30 m	MS4800-CBLMT-30M	

Resource Module

Appearance	Model	Application
	MS4800-RM6	A special terminal module for using muting.

Water-resistant IP67 Cases (for Both Transmitters and Receivers, 2 Cases Per Set) (10% Maximum Sensing Distance Attenuation Per Case)

Type	Appearance	Model	Remarks
For individual use		MS4800-IP67-□ *	Accessories: Two mounting brackets (one top, one bottom) Material: Acryl
For series-connection use		MSF4800-IP67-□ *	

*A 4-digit number indicating the protective height of the Light Curtain must be included in place of the box (□) in the model number.

Spatter Protection Covers (for Both Transmitters and Receivers, 2 Covers Per Set) (10% Maximum Sensing Distance Attenuation Per Cover)

Type	Appearance	Model	Remarks
MS4800 Cover		MS4800WS-□ *	Material: Acryl

*A 4-digit number indicating the protective height of the Light Curtain must be included in place of the box (□) in the model number.

Specifications (For details, refer to the *Instruction Manual* or *User's Manual*.)

Safety Light Curtains

MS/MSF4800-series Safety Light Curtains

		Series	Advanced Series		Basic Series	
Item	Model	Individual use	MS4800A-30-□	MS4800A-40-□	MS4800B-30-□	MS4800B-40-□
		Series connection	MSF4800A-30-□	MSF4800A-40-□	MSF4800B-30-□	MSF4800B-40-□
Sensor type		Type 4 Safety Light Curtain				
Setting tool connection		Connectable				
Applicable safety category		Category 4, 3, 2, 1, or B				
Minimum detectable object		Opaque object: 30-mm dia.	Opaque object: 40-mm dia.	Opaque object: 30-mm dia.	Opaque object: 40-mm dia.	
Beam gap (P)		20 mm	30 mm	20 mm	30 mm	
Number of beams (n)		14 to 106	12 to 68	14 to 106	12 to 68	
Protective height (PH)		280 to 2120 mm	360 to 2040 mm	280 to 2120 mm	360 to 2040 mm	
Sensing distance *1		0.3 to 20 m (selectable from 0.3 to 8 m with the Programming and Diagnostics Module)				
Lens diameter		Diameter 7 mm				
Response time (under stable light incident condition) (Refer to page 15 for details.)	ON to OFF	Individual: 14 to 32 ms	Individual: 14 to 23 ms	Individual: 14 to 32 ms	Individual: 14 to 23 ms	
	OFF to ON	320 ms max.				
Startup waiting time		3.5 s max. for individual use, 4.5 s max. for series connection				
Power supply voltage (Vs)		24 VDC ±20% (ripple p-p: 5% max.)				
Current consumption *2 (no load)	Transmitter	285 mA max.				
	Receiver	450 mA max.				
Light source (emitted wavelength)		Infrared LEDs (wavelength: 880 nm)				
Effective aperture angle (EAA)		Within ±2.5° for the Transmitter and Receiver at a sensing distance of at least 3 m according to IEC 61496-2.				
Control output (OSSD) *3		Output transistor: PNP × 2, Load current: 625 mA max. (at 24 VDC), short-circuit protection				
Auxiliary output *3 (non-safety output)		Output transistor: PNP × 1 or NPN × 1, selectable with the Programming and Diagnostics Module, Load current: 100 mA max. (at 24 VDC) Output mode: Control output synchronizing or alarm is selectable with the Programming and Diagnostics Module			Output transistor: PNP × 1, Load current: 100 mA max. (at 24 VDC) Output mode: Control output synchronizing	
Output operation mode		Control output 1, 2: Light-ON Auxiliary output: Control Output Synchronizing Mode: Auxiliary output goes ON when control output goes ON Alarm Mode: Auxiliary output goes ON when the MS4800 enters alarm (lockout) condition				
Input voltage		External device monitoring input ON voltage: 11 to 28.8 V, OFF voltage: 0 to 2.6 V Start input ON voltage: 11 to 28.8 V, OFF voltage: 0 to 1.2 V For the MS4800B, use NC contacts for the start input switch. For the MS4800A, refer to <i>Start Input Methods (MS/MSF4800A Only)</i> on page 24.				
Internal indicators	Transmitter	Transmitter Indicator (Yellow): Indicator is ON when transmitting				
	Receiver	Blanking Indicator (Orange): Indicator is ON in Blanking Active State Interlock or Alarm (Lockout) Indicator: Indicator is ON in Interlock State, and indicator flashes in Alarm (Lockout) State Machine Run/Stop Indicator (Green/Red): Green indicator is ON when Control Output is ON, and red indicator is ON when Control Output is OFF				
Mutual interference prevention function		The scan code (A/B) can be switched with the Programming and Diagnostics Module				
Series connection		MSF4800 only • Connectable segments: 4 max. • Total number of beams: 256 max. • Maximum cable length between segments: 10 m • Response time when connected: Refer to page 15.				
Test functions		• Self test (when power is turned ON and while power is supplied) • External test (light emission stop function by test input)				

*1. Use of the Spatter Protection Cover causes a 10% maximum sensing distance attenuation.

*2. The consumption current must not exceed 1.35 A for both the control outputs and auxiliary output. The rated current is the sum of the Transmitter (285 mA), Receiver (450 mA), control output 1 (625 mA), control output 2 (625 mA), and auxiliary output (100 mA).

*3. The 24-VDC value is a nominal value. The actual voltage depends on the supply voltage. Actual voltage = Supply voltage – 1 V.

Item	Model	Series	Advanced Series		Basic Series	
		Individual use	MS4800A-30-□	MS4800A-40-□	MS4800B-30-□	MS4800B-40-□
		Series connection	MSF4800A-30-□	MSF4800A-40-□	MSF4800B-30-□	MSF4800B-40-□
Safety functions		<ul style="list-style-type: none"> • Selection of auto start mode and interlock mode • External device monitoring • Muting (MSF4800A only) (MS4800-RM6 (sold separately) is required.) • Fixed blanking • Floating blanking • Monitored blanking • Reduced resolution blanking 		<ul style="list-style-type: none"> • Selection of auto start mode and interlock mode • External device monitoring 		
Connection method		Power supply connectors (M12, Transmitter: 5-pin, Receiver: 8-pin) Series-connection connectors: (M12, Transmitter: 4-pin, Receiver: 4-pin)				
Protective circuit		Output short-circuit protection, reverse polarity protection				
Ambient temperature		Operating: -10 to 55°C (with no icing), storage: -25 to 70°C				
Ambient humidity		95% max. (with no condensation)				
Insulation resistance		20 MΩ min. (at 500 VDC)				
Dielectric strength		Transmitter: 350 VAC 60 Hz 1 min Receiver: 500 VDC 1 min				
Degree of protection		IP65 (IEC 60529)				
Vibration resistance		Malfunction: 10 to 55 Hz, 0.7-mm double amplitude, 20 sweeps in X, Y, and Z directions				
Shock resistance		Malfunction: 10G, 1,000 times in X, Y, and Z directions				
Materials		Case: Aluminum with polyurethane powder coating Cap: Polycarbonate				
Weight (packed state)		<ul style="list-style-type: none"> • MS4800□-30-□□□□ Weight (g) = α x Protective height + 349 • MSF4800□-30-□□□□ Weight (g) = α x Protective height + 361 • MSF4800□-30-□□□□-XR2 Weight (g) = α x Protective height • MS4800□-40-□□□□ Weight (g) = α x Protective height + 370 • MSF4800□-40-□□□□ Weight (g) = α x Protective height + 382 • MSF4800□-40-□□□□-XR2 Weight (g) = α x Protective height <p>The values for α are as follows: For protective height from 240 to 280: 10 For protective height from 1,120 to 1,840: 7 For protective height from 320 to 360: 9 For protective height from 1,880 to 2,120: 6 For protective height from 400 to 1,080: 8</p>				
Accessories		Test rod, Instruction Manual, mounting set (2 top, 2 bottom mounting brackets), surge absorber				
Applicable standards		IEC 61496-1, EN 61496-1, UL 61496-1 Type 4 ESPE (Electro-Sensitive Protective Equipment), IEC 61496-2, CLC/TS61496-2, UL 61496-2 Type 4 AOPD (Active Opto-electronic Protective Devices), IEC 61508 SIL3				

Response Time

Curtains Used Individually (1-segment System)

Minimum number of beams	Maximum number of beams	Response time (ms)	
		Normal	Delayed *
0	16	14	23
17	71	23	38
72	126	32	53
127	180	41	68
181	235	50	83
236	256	59	99

Curtains Used in Series Connection (2-segment System)

Minimum number of beams	Maximum number of beams	Response time (ms)	
		Normal	Delayed *
0	65	23	38
66	120	32	53
121	174	41	68
175	229	50	83
230	256	59	99

Curtains Used in Series Connection (3-segment System)

Minimum number of beams	Maximum number of beams	Response time (ms)	
		Normal	Delayed *
0	59	23	38
60	114	32	53
115	168	41	68
169	223	50	83
224	256	59	99

Curtains Used in Series Connection (4-segment System)

Minimum number of beams	Maximum number of beams	Response time (ms)	
		Normal	Delayed *
0	53	23	38
54	108	32	53
109	162	41	68
163	217	50	83
218	256	59	99

*Refer to *Response Time Adjustment (MS/MSF4800A Only)* on page 24.

Cable Extension Length

The maximum length and wire gauge for input and output signals are given in the following table.

Type	Signal name	Wire gauge	Rated maximum length
Receiver	Control outputs 1 and 2	22 AWG (0.32 mm)	300-mA load: 45 m, 625-mA load: 22 m
	Auxiliary output	22 AWG (0.32 mm)	50 m
	Start input	24 AWG (0.20 mm)	50 m
	External device monitoring (EDM) input	24 AWG (0.20 mm)	50 m
Transmitter	+24 V, 0 V	20 AWG (0.52 mm)	1.8-A load: 12.5 m, 1-A load: 22 m
	+24 V, 0 V	22 AWG (0.32 mm)	0.3-A load: 47 m
	Machine test signal (MTS)	22 AWG (0.32 mm)	50 m

Note: Keep the cable length within the rated length. Failure to do so is dangerous because it may prevent safety functions from operating normally.

Accessories

Resource Module

Item	Model	MS4800-RM6
Input power supply		24 VDC \pm 20%, 30 mA max.
Ambient temperature		0 to 55°C
Ambient humidity		95% max. (with no condensation)
Storage temperature		-25 to 75°C
Vibration resistance		Malfunction: 10 to 55 Hz, 0.7-mm double amplitude, 20 sweeps in X, Y, and Z directions
Shock resistance		Malfunction: 10G, 1,000 times in X, Y, and Z directions
Degree of protection		IP20 (IEC 60529)
Muting sensor *1		PNP 24-VDC (power consumption: 20 mA) Dark-ON/Light-ON or NO/NC combination
Muting indicator output *2		10 to 100 mA (NPN), 30 VDC max.
Applicable safety category		IEC 61496-1 Type 4

*1. For details, refer to *Mini Safe 4800 Series Light Curtains Installation and Operating Manual*.

*2. The muting indicator output contains a current monitoring circuit to confirm normal operation. Connect an external indicator load that supplies 10 to 100 mA of current.

Programming and Diagnostics Module

Item	Model	MS4800-PDM
Display		LCD multi-line display
Language capability		English, Japanese
Degree of protection		Conforms to IP 65

Connection Circuit Examples

Examples of Safety Circuits

Example When Using the MS/MSF4800 Individually (Category 4)

MS/MSF4800 Settings

- Use Start/Restart Interlock Mode. (Use the PDM to set the operation mode to Start/Restart Interlock Mode.)
- Use the external relay monitor function. (Use the PDM to turn ON the EDM function.)
- Use the test input. (Use the PDM to enable the test input.)

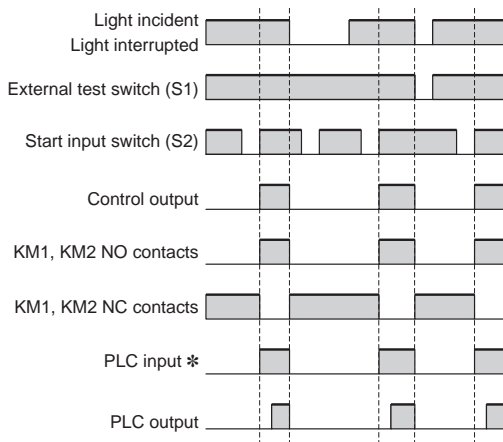
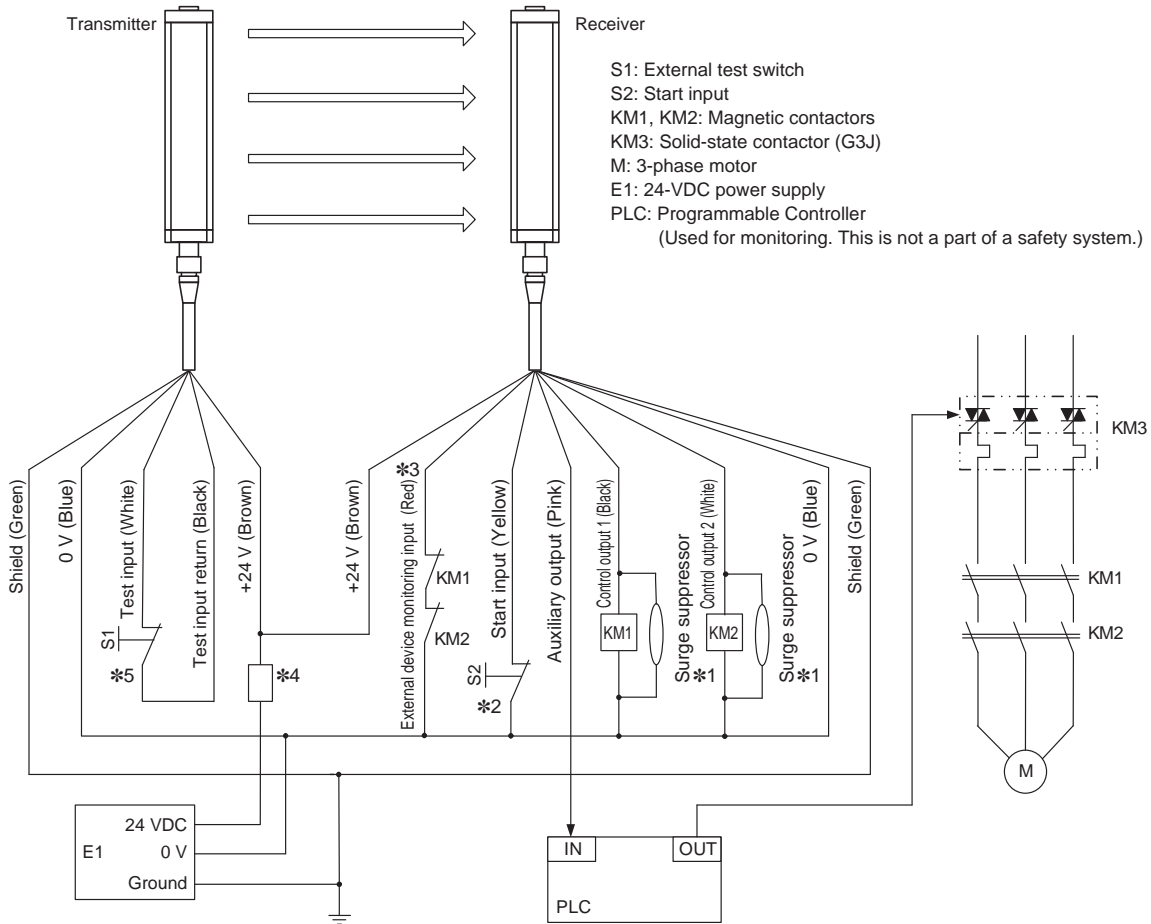

* The output operation mode of the auxiliary output is PNP Control Output Synchronizing Mode (default).

- *1. Make sure that both external devices have been suitably suppressed.
- *2. For the MS/MSF4800B, use an NC contacts for the start input switch. For the MS/MSF4800A, refer to *Start Input Methods (MS/MSF4800A Only)* on page 24. When using Auto Start Mode, use the PDM to check that the operation mode is set to Auto Start Mode (default), and connect the start input to 0 V.
- *3. With the default setting, the external relay monitor input (EDM) is set so that the EDM is enabled and disabled with the start input. This will prevent accessing the normal functionality of the start input. To use both the start input and the EDM as shown in the example safety circuits on this page, connect the PDM to the Receiver and use the PDM to enable the EDM. If the EDM is not necessary, use the PDM to disable the EDM, and then connect the EDM (red wire) to 0 V. For details, refer to *Mini Safe 4800 Series Light Curtains Installation and Operating Manual*.
- *4. Fuse (provided by the customer). (The fuse is not required if only the power supply satisfies output characteristic requirements for class 2 circuit or limited voltage current circuit defined by UL508.) (e.g., S82K and S8VS)
- *5. The test input is disabled with the default setting. To use the test input, connect the PDM to the Receiver and enable the test input, and use NC contacts for the test input.

Example When Connected to the G9SA-301 Controller (Category 4)

MS/MSF4800 Settings

- Auto start mode
- External device monitoring not used
- Test input used.
(Use the PDM to enable the test input.)

G9SA-301 Settings

- Manual reset mode
- Feedback loop used
- Emergency stop switch used

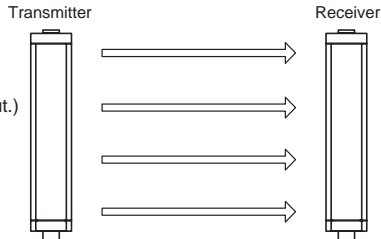

- S1: External test switch
- S2: Start input
- S3: Interlock reset switch
- S4: Emergency stop switch (A165E, A22E, etc.)
- KM1, KM2: Magnetic contactors
- KM3: Solid-state contactor (G3J)
- M: 3-phase motor
- E1: 24-VDC power supply
- PLC: Programmable Controller
(Used for monitoring. This is not a part of a safety system.)

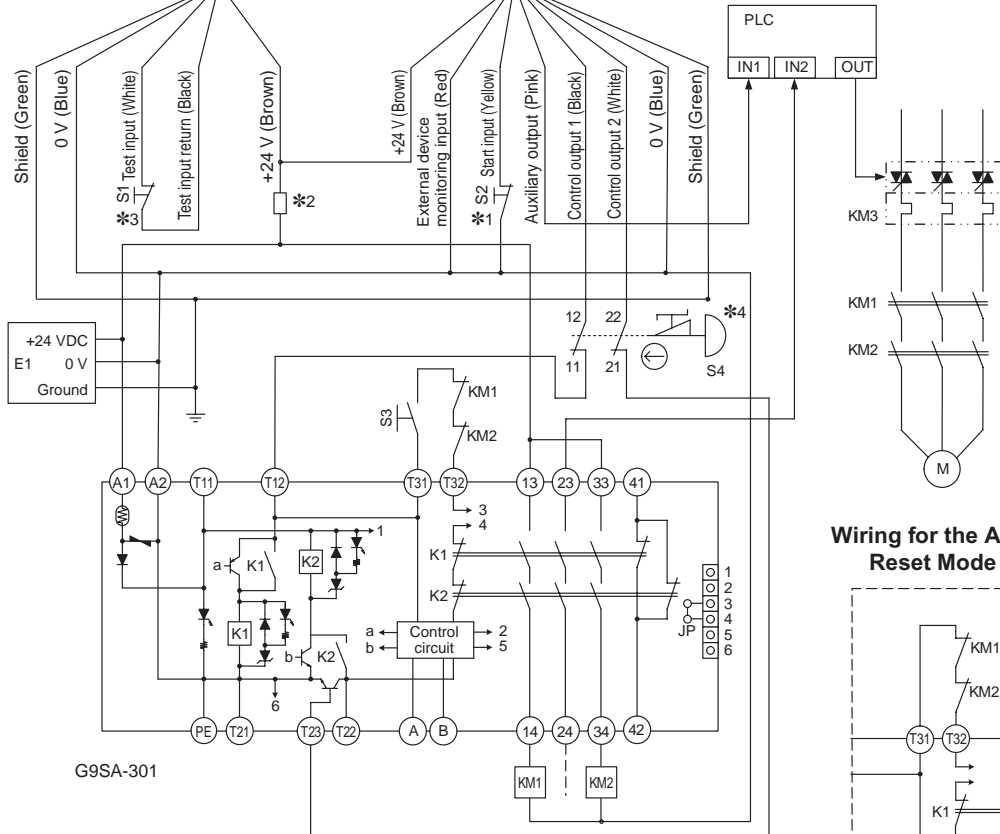

Wiring for the Auto Reset Mode

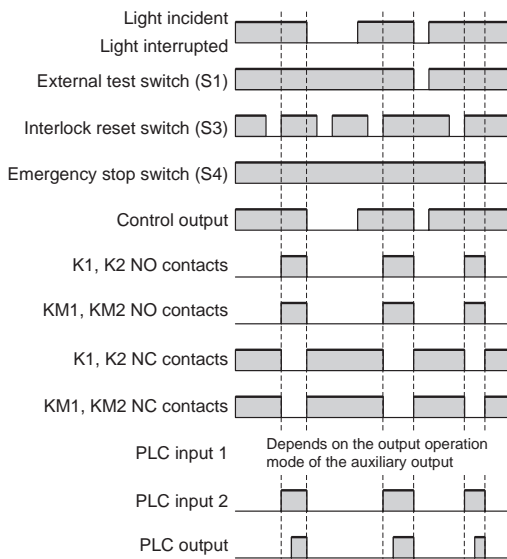
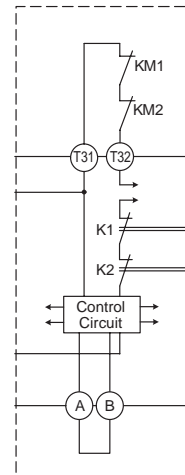

- *1. For the MS/MSF4800B, use NC contacts for the start input switch.
For the MS/MSF4800A, refer to *Start Input Methods (MS/MSF4800A Only)* on page 24.
- *2. Fuse (provided by the customer).
(The fuse is not required if only the power supply satisfies output characteristic requirements for class 2 circuit or limited voltage current circuit defined by UL508.) (e.g., S82K and S8VS)
- *3. The test input is disabled with the default setting. To use the test input, connect the PDM to the Receiver and enable the test input, and use NC contacts for the test input.
- *4. If an emergency stop switch is not used, connect control output 1 to T12 terminal and control output 2 to T23 terminal directly.

Example When Connected to the G9SB-301-D Controller (Category 4)

MS/MSF4800 Settings

- Auto start mode
 - External device monitoring not used
 - Test input used.
- (Use the PDM to enable the test input.)

G9SB-301-D Settings

- Manual reset mode
- Feedback loop used
- Emergency stop switch used

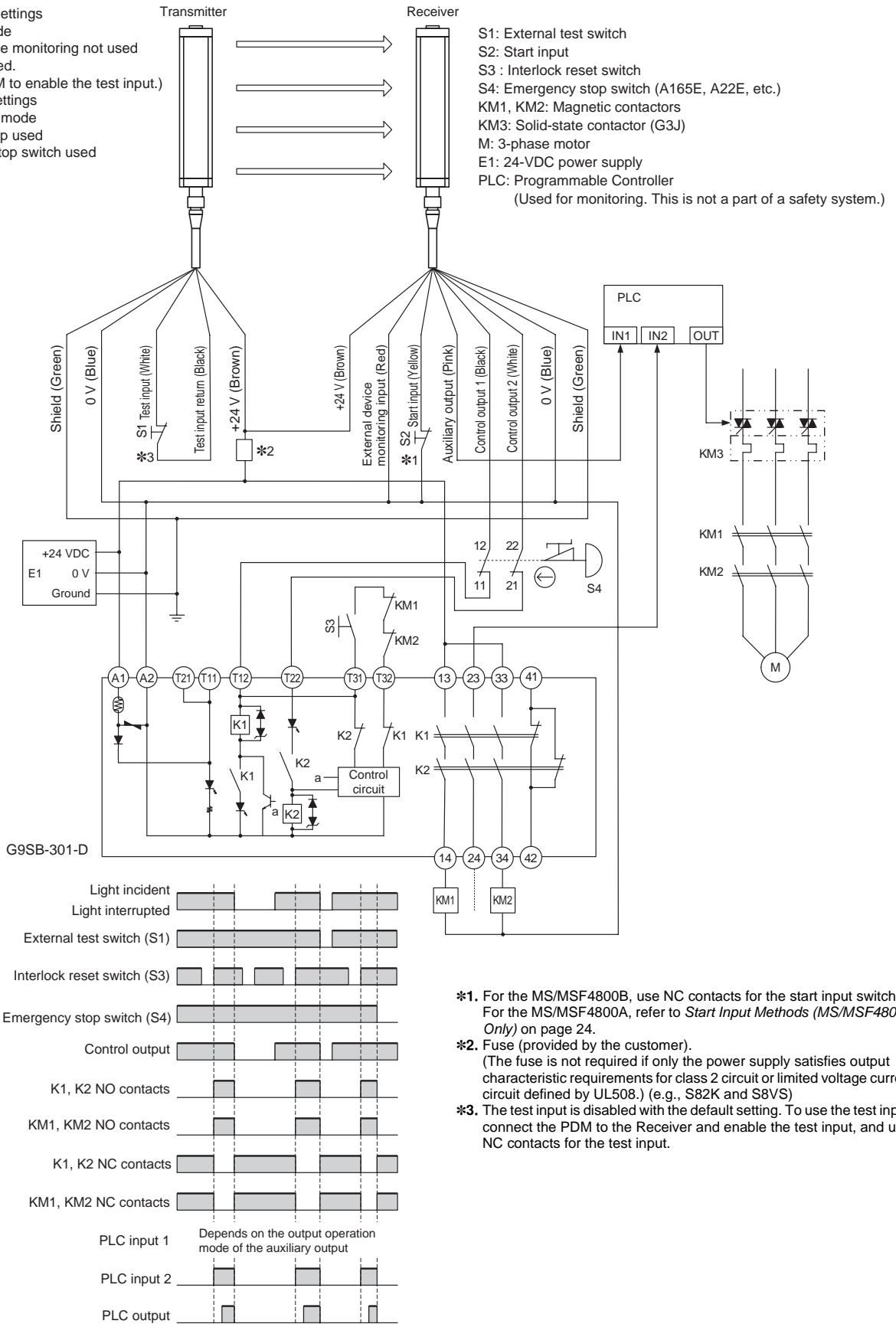

Example When Connected to the G9SX-AD322-T15 Controller (Category 4)

MS/MSF4800 Settings

- Auto start mode
- External device monitoring not used
- Test input used. (Use the PDM to enable the test input.)

G9SX-AD322-T15 Settings

- Auto Reset Mode
- Feedback loop used

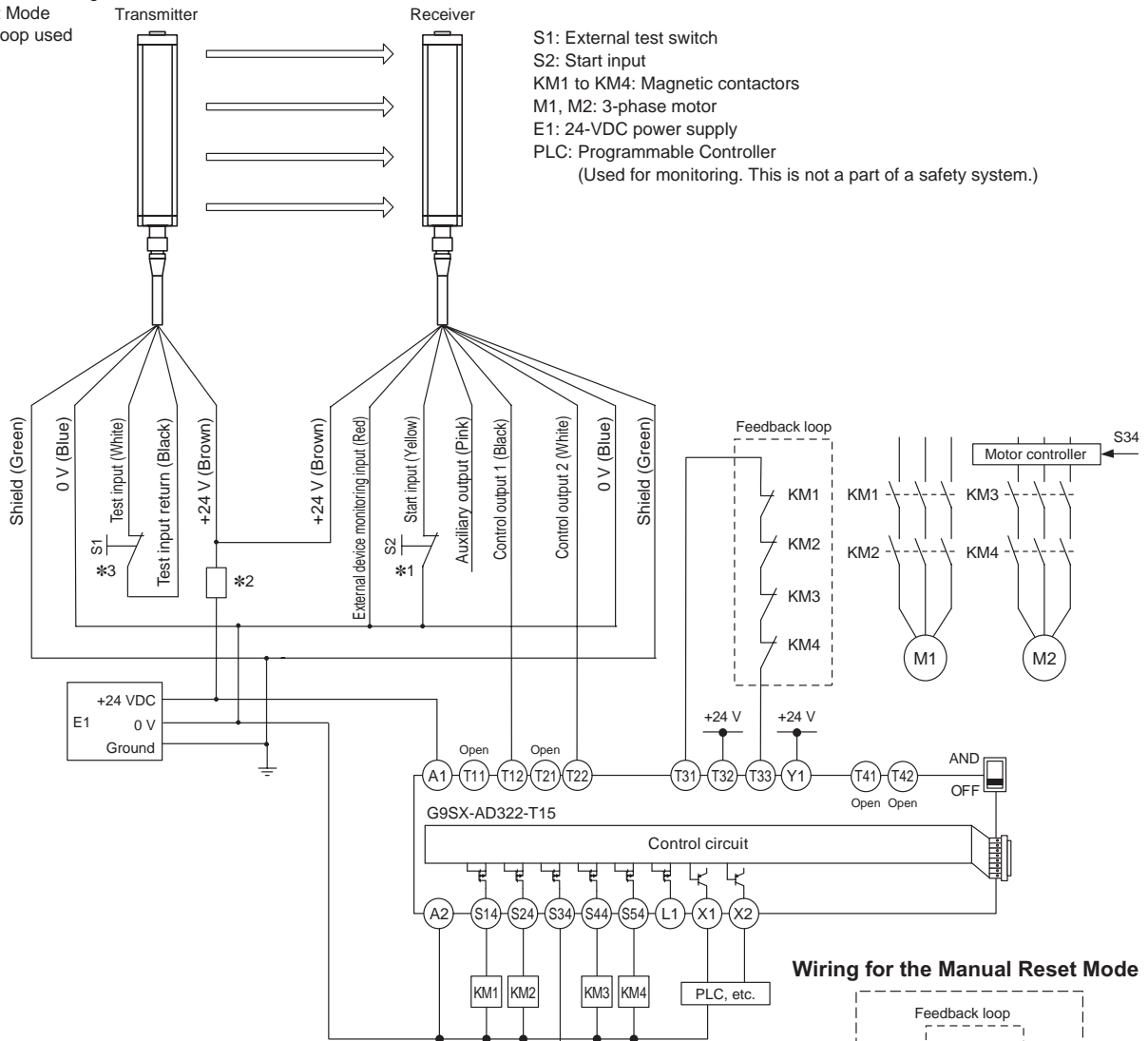

S1: External test switch
 S2: Start input
 KM1 to KM4: Magnetic contactors
 M1, M2: 3-phase motor
 E1: 24-VDC power supply
 PLC: Programmable Controller
 (Used for monitoring. This is not a part of a safety system.)

Wiring for the Manual Reset Mode

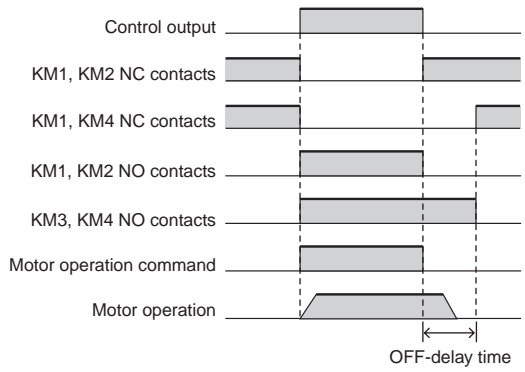
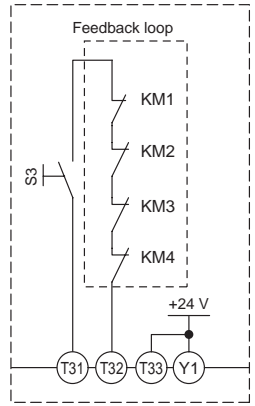

- *1. For the MS/MSF4800B, use NC contacts for the start input switch. For the MS/MSF4800A, refer to *Start Input Methods (MS/MSF4800A Only)* on page 24.
- *2. Fuse (provided by the customer). (The fuse is not required if only the power supply satisfies output characteristic requirements for class 2 circuit or limited voltage current circuit defined by UL508. (e.g., S82K and S8VS))
- *3. The test input is disabled with the default setting. To use the test input, connect the PDM to the Receiver and enable the test input, and use NC contacts for the test input.

Connection to the MS4800-RM6 Resource Module (MSF4800A Only)

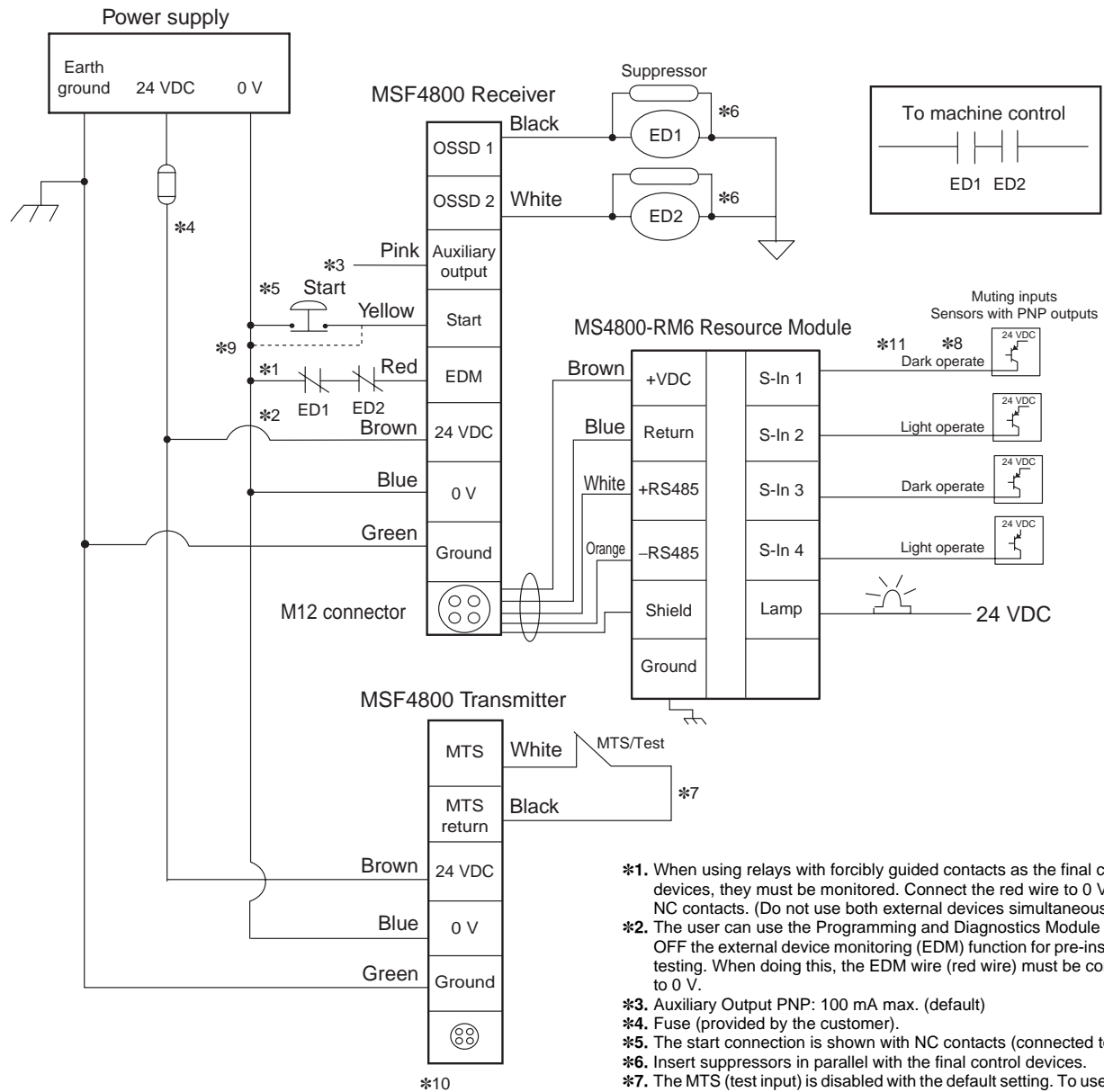

- *1. When using relays with forcibly guided contacts as the final control devices, they must be monitored. Connect the red wire to 0 V via the NC contacts. (Do not use both external devices simultaneously.)
- *2. The user can use the Programming and Diagnostics Module to turn OFF the external device monitoring (EDM) function for pre-installation testing. When doing this, the EDM wire (red wire) must be connected to 0 V.
- *3. Auxiliary Output PNP: 100 mA max. (default)
- *4. Fuse (provided by the customer).
- *5. The start connection is shown with NC contacts (connected to 0 V).
- *6. Insert suppressors in parallel with the final control devices.
- *7. The MTS (test input) is disabled with the default setting. To use the test input, connect the PDM to the Receiver and enable the test input, and use NC contacts for the test input.
- *8. For details, refer to the *Mini Safe 4800 Series Safety Light Curtains Installation and Operating Manual*.
- *9. Connect the yellow wire to 24 VDC to enable external device monitoring (EDM), and to 0 V to disable EDM.
- *10. Not used.
- *11. There is no need to connect sensor inputs that are not used.

Nomenclature

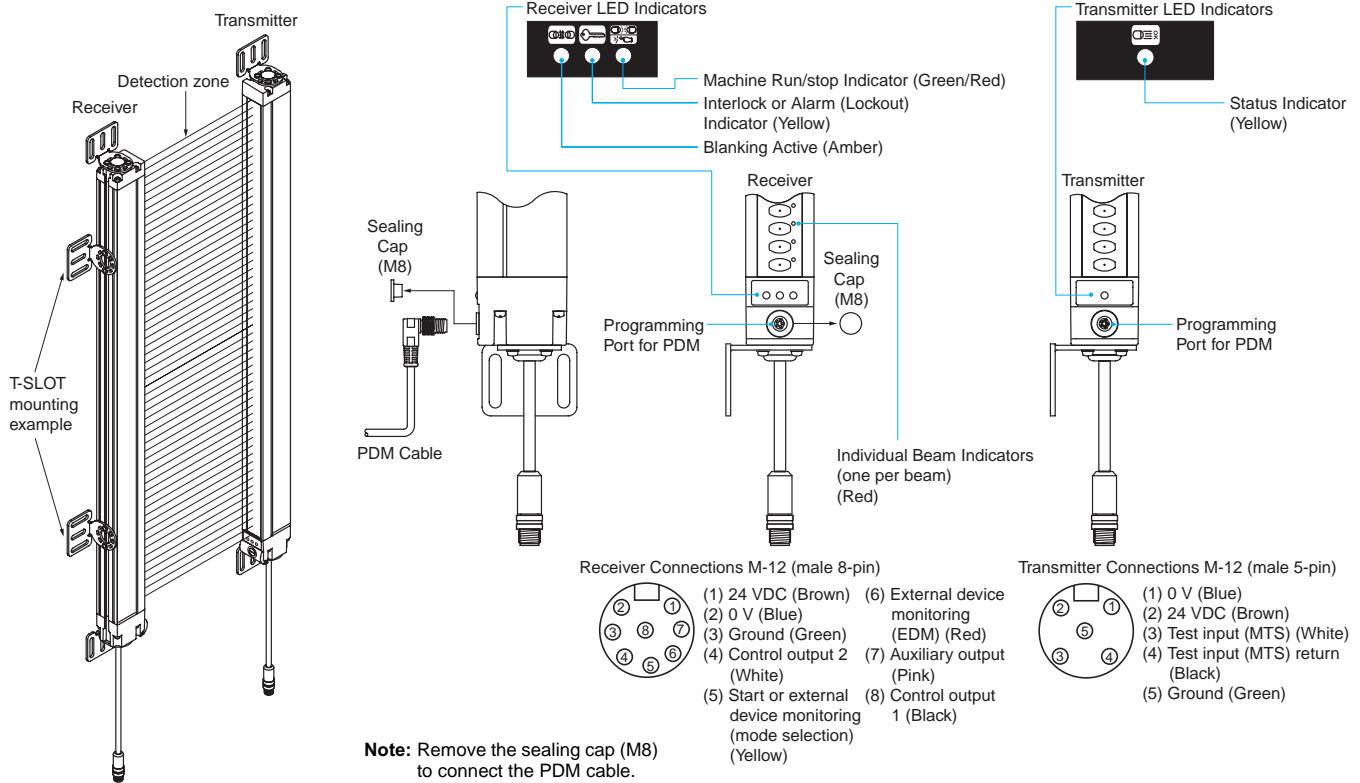

Individual Beam Indicators (IBI)

All MS4800 Safety Light Curtains have an Individual Beam Indicator (IBI) next to each infrared beam on the Receiver. The IBI indicates whether the beam is interrupted or clear. When the beam is interrupted, the IBI goes ON; when it is clear, the IBI goes OFF. If there is less than 10 clear beams, every other IBI will light to indicate that the MS/MSF4800 is not synchronized.

Example of IBI Indication for an Error (Error Code 34)

Front View of the Receiver

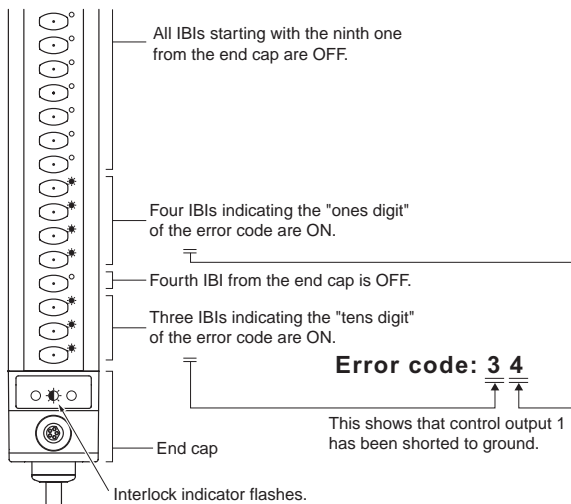

Note: For details on error codes, refer to the *Mini Safe 4800 Series Safety Light Curtains Installation and Operating Manual*.

Receiver LED Indicators

○ OFF ◐ Flashing ● ON

Operating condition	Condition indication	Description
Machine Run State		Two Receiver control outputs (safety outputs) are ON, and the green Machine Run indicator is ON.
Machine Stop State		Two Receiver control outputs (safety outputs) are OFF, and the red Machine Stop indicator is ON.
Interlock State		Two Receiver control outputs (safety outputs) are OFF, and the red Machine Stop indicator and the yellow Interlock indicator are ON.
Alarm (Lockout) state		Two Receiver control outputs (safety outputs) are OFF, the red Machine Stop indicator is ON, the yellow Interlock indicator is flashing, and the auxiliary output is OFF.
Blanking Active state		Operating with blanking enabled.

Transmitter LED Indicators

◐ Flashing ● ON

Operating condition	Condition indication	Description
Transmitting state		When the Transmitter receives power and enters the Transmitting state, the indicator turns ON. When the Machine Test Signal (MTS) is enabled, the Transmitter enters the Transmitting Stop state, and the indicator turns OFF.
Error state/PDM Programming state		When an error occurs due to the Transmitter, or when the Programming and Diagnostics Module is being used to change a setting, the indicator flashes.

Safety Functions

Operation Modes

Auto Start

If no objects are detected in the sensing area when the power is turned ON in Auto Start Mode, the system enters the Machine Run State. If an object is then detected, the system changes from the Machine Run State to the Machine Stop State, and remains in that state until the object is removed. When the intrusion into the sensing area disappears, the system automatically changes from the Machine Stop State to the Machine Run State.

Start Interlock

If no objects are in the sensing area when the power is turned ON in Start Interlock Mode and an alarm (lockout) condition does not occur, the system enters the Interlock State. To shift to the Machine Run State, an operator must press and release the Start Button on the Safety Light Curtain. If an object intrudes in the sensing area during the Machine Run State, the system will change to the Machine Stop State. When the object is removed from the sensing area, the system will automatically shift to the Machine Run State.

Start/Restart Interlock

If no objects are in the sensing area when the power is turned ON in Start/Restart Interlock Mode and an alarm (lockout) condition does not occur, the system enters the Interlock State. To shift to the Machine Run State, an operator must press and release the Start Button on the Safety Light Curtain. If an object intrudes in the sensing area during the Machine Run State, the system will change to the Machine Stop State. When the object is removed from the sensing area, the system will shift to the Interlock State instead of automatically shifting to the Machine Run State. To shift to the Machine Run State, an operator must press and release the Start Button. When there is an object in the sensing area, the Start Button is disabled.

Diagnostic Functions

External Device Monitoring (EDM) (MPCE Monitoring)

This function detects malfunctions, such as welded contacts in external relays (or contactors) that control the hazardous area of a machine. This function constantly monitors that a specified voltage is applied to the Receiver's external device monitoring input line, and enters LOCKOUT state when an error occurs. The relay's operational delay can be up to 300 ms without being evaluated as an error.

To utilize this function properly, use relays and contactors that have a forcibly guided contact structure.

Enabling/Disabling External Device Monitoring

The external device monitoring can be enabled or disabled

Blanking Functions (Advanced Series Only)

Fixed Blanking

This function is used when a machine or workpiece constantly interrupts beams in a part of the sensing area. Fixed blanking allows the Safety Light Curtain to remain in the Machine Run State while the obstruction in the sensing area as a non-moving object. The output is turned OFF when a beam other than the set fixed blanking beams is interrupted, or when light is incident on a fixed blanking beam.

Floating Blanking

This function turns OFF the output when the total number of interrupted beams inside the sensing area exceeds the number of set beams (1 or 2).

Monitored Blanking

This function is used when a machine or workpiece constantly interrupts beams in a part of the sensing area and moves within the sensing area. Monitored blanking allows the Safety Light Curtain to remain in the Machine Run State while the obstruction moves within the sensing area. The output is turned OFF when the machine or workpiece disappears from the monitored blanking area that was set by teaching, or when the total number of interrupted beams increases due to a different obstruction.

Reduced Resolution Blanking

When the resolution of the MS/MSF4800A is reduced, the size of the minimum detectable object is increased. The output will not turn OFF regardless of how many continuous interrupted beams there are in the sensing area as long as the beams are fewer than the set number (1, 2, or 3 beams). When an object whose size exceeds the set number of beams intrudes, the output is turned OFF. For example, in an application where a conveyor cart approaches a robot work area, the Safety Light Curtain can be set so that it does not detect only the wheels of the cart, allowing the MS/MSF4800A to be used as a presence sensing device.

Muting Functions (MSF4800A Only)

Use of the MS4800-RM6 Resource Module (sold separately) makes it possible to temporarily disable the Safety Light Curtain. Select from among four muting modes to match each application with the appropriate number and placement of muting sensors.

Note: For details on blanking and muting, refer to the *Mini Safe 4800 Series Safety Light Curtains Installation and Operating Manual*.

with the Programming and Diagnostics Module. When using the Auto Start Mode, enabling and disabling can be switched by combining the start input line with the external device monitoring wiring.

Note: For details, refer to the *Mini Safe 4800 Series Safety Light Curtains Installation and Operating Manual*.

Machine Test Signal (MTS)

The Machine Test Signal (MTS) is used to confirm that the safety system stops correctly when an MS/MSF4800 beam is interrupted by purposely halting the emission with an external signal. MTS is provided by placing a normally closed switch across the MTS and MTS Return lines of the Transmitter. A close-to-open transition on this switch will enable the MTS and halt the emission.

Other Functions

Sensing Distance Selection

The Programming and Diagnostics Module can be used to select the sensing distance. The Short Range Mode is 8 m, and the Long Range Mode is 20 m (default). This function is useful when there are many Safety Light Curtains operating within a small space and the possibility of mutual interference is likely.

Response Time Adjustment (MS/MSF4800A Only)

The MS4800 allows the user to slow down the scan rate of the Safety Light Curtain for maximum immunity against environmental interference. This function may be used in harsh environmental conditions where electrical noise, ambient smoke, or dust and flying debris interfere with the Safety Light Curtain. For details, refer to **Response Time** on page 15.

WARNING

Recalculate the safety distance whenever the response time has been changed.

Start Input Methods (MS/MSF4800A Only)

For the MS/MSF4800A, select one of the following four combinations of switch and ON/OFF logic for connection to the Start Input line. (The default is the 0-V connection with NC contacts.) As the following timing chart shows, the switch is reset by pressing it once, then returning it.

NO1: Normally Open (with 0-VDC Connection)

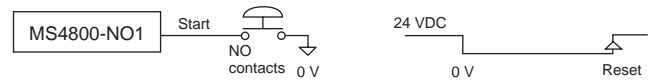

NO2: Normally Open (with 24-VDC Connection)

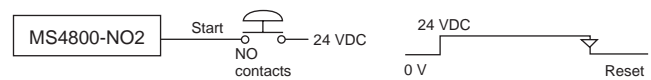

NC1: Normally Closed (with 0-VDC Connection) (Default)

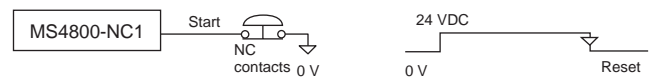

NC2: Normally Closed (with 24-VDC Connection) (Default)

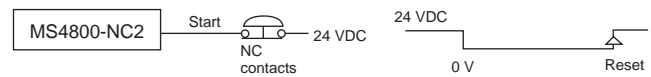

Optical Synchronization

The synchronization between the MS4800-series Transmitter and Receiver is optical. To establish synchronization, the system needs to have a certain number of consecutive clear beams.

Note: For details, refer to the *Mini Safe 4800 Series Safety Light Curtains Installation and Operating Manual*.

Dimensions

Safety Light Curtains

Safety Light Curtains Used Individually

MS4800

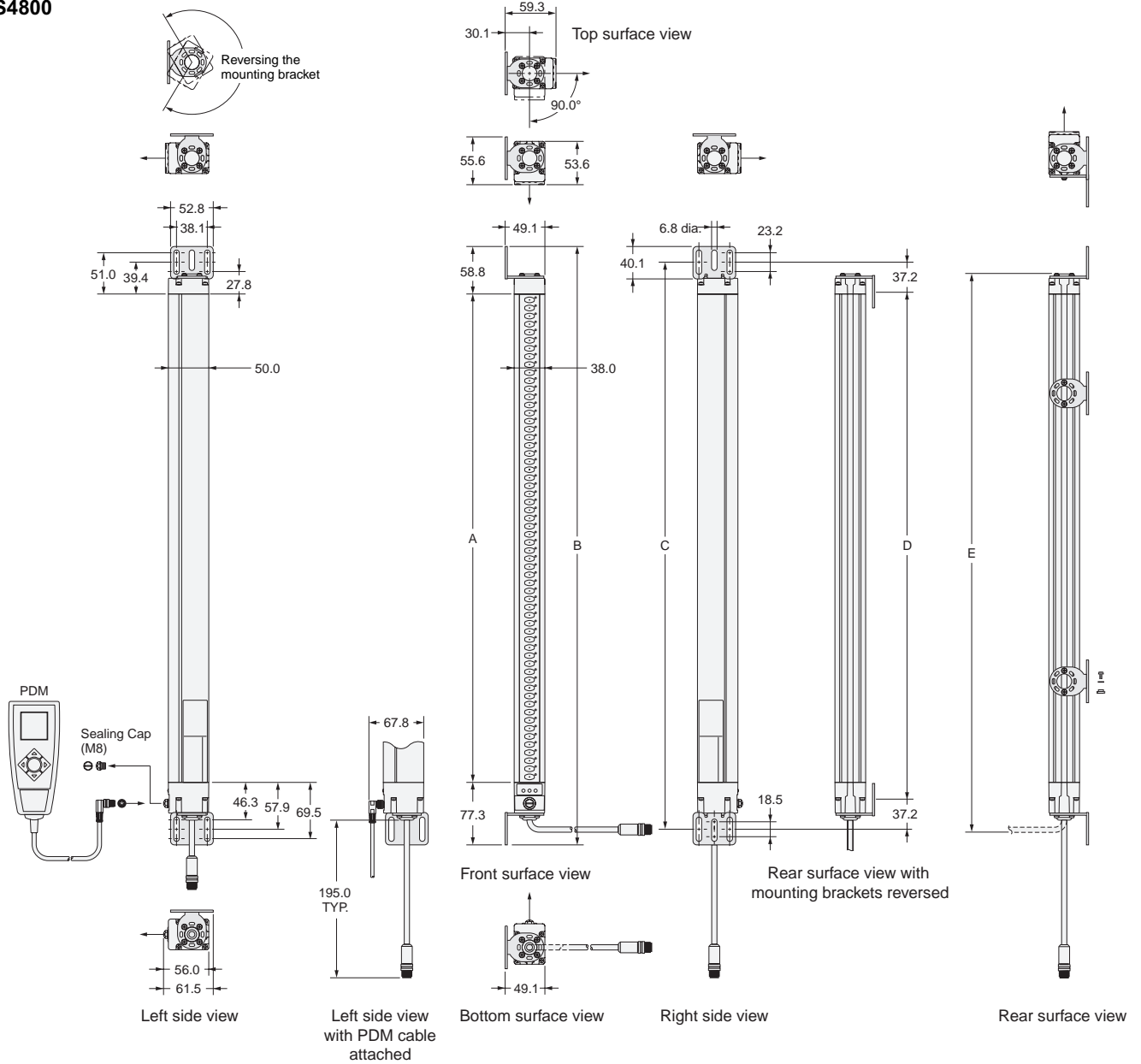

MS4800-30 Transmitter and Receiver Dimensions

Dimensions Sensing area	A	B	C	D	E
280	284.4	420.4	381.7	307.3	371.3
320	324.8	460.8	422.1	347.7	411.7
360	364.5	500.5	461.8	387.4	451.4
400	404.2	540.2	501.5	427.1	491.1
440	443.9	579.9	541.2	466.8	530.8
480	484.3	620.3	581.6	507.2	571.2
520	523.4	659.4	620.7	546.3	610.3
560	563.7	699.7	661.0	586.6	650.6
600	604.1	740.1	701.4	627.0	691.0
640	643.9	779.9	741.2	666.8	730.8
680	683.6	819.6	780.9	706.5	770.5
720	724.0	860.0	821.3	746.9	810.9
760	763.0	899.0	860.3	785.9	849.9
800	803.5	939.5	900.8	826.4	890.4
840	843.8	979.8	941.1	866.7	930.7
880	882.8	1018.8	980.1	905.7	969.7
920	922.5	1058.5	1019.8	945.4	1009.4
960	963.6	1099.6	1060.9	986.5	1050.5
1000	1002.6	1138.6	1099.9	1025.5	1089.5
1040	1042.9	1178.9	1140.2	1065.8	1129.8
1080	1083.9	1219.9	1181.2	1106.8	1170.8
1120	1122.3	1258.3	1219.6	1145.2	1209.2
1160	1162.7	1298.7	1260.0	1185.6	1249.6
1200	1203.8	1339.8	1301.1	1226.7	1290.7
1240	1242.1	1378.1	1339.4	1265.0	1329.0
1280	1281.8	1417.8	1379.1	1304.7	1368.7
1320	1323.6	1459.6	1420.9	1346.5	1410.5
1360	1362.0	1498.0	1459.3	1384.9	1448.9
1400	1401.7	1537.7	1499.0	1424.6	1488.6
1440	1443.4	1579.4	1540.7	1466.3	1530.3
1480	1481.8	1617.8	1579.1	1504.7	1568.7
1520	1521.5	1657.5	1618.8	1544.4	1608.4
1560	1563.3	1699.3	1660.6	1586.2	1650.2
1600	1600.9	1736.9	1698.2	1623.8	1687.8
1640	1641.3	1777.3	1738.6	1664.2	1728.2
1680	1681.3	1817.3	1778.6	1704.2	1768.2
1720	1720.8	1856.8	1818.1	1743.7	1807.7
1760	1760.5	1896.5	1857.8	1783.4	1847.4
1800	1802.9	1938.9	1900.2	1825.8	1889.8
1840	1840.6	1976.6	1937.9	1863.5	1927.5
1880	1880.3	2016.3	1977.6	1903.2	1967.2
1920	1922.8	2058.8	2020.1	1945.7	2009.7
1960	1960.4	2096.4	2057.7	1983.3	2047.3
2000	2000.1	2136.1	2097.4	2023.0	2087.0
2040	2042.6	2178.6	2139.9	2065.5	2129.5
2080	2079.6	2215.6	2176.9	2102.5	2166.5
2120	2120.0	2256.0	2217.3	2142.9	2206.9

MS4800-40 Transmitter and Receiver Dimensions

Dimensions Sensing area	A	B	C	D	E
360	364.5	500.5	461.8	387.4	451.4
480	484.3	620.3	581.6	507.2	571.2
600	604.1	740.1	701.4	627.0	691.0
720	724.0	860.0	821.3	746.9	810.9
840	843.4	979.4	940.7	866.3	930.3
960	963.6	1099.6	1060.9	986.5	1050.5
1080	1083.9	1219.9	1181.2	1106.8	1170.8
1200	1203.8	1339.8	1301.1	1226.7	1290.7
1320	1323.6	1459.6	1420.9	1346.5	1410.5
1440	1443.4	1579.4	1540.7	1466.3	1530.3
1560	1563.3	1699.3	1660.6	1586.2	1650.2
1680	1683.1	1819.1	1780.4	1706.0	1770.0
1800	1802.9	1938.9	1900.2	1825.8	1889.8
1920	1922.8	2058.8	2020.1	1945.7	2009.7
2040	2042.6	2178.6	2139.9	2065.5	2129.5

Safety Light Curtains in Series Connection

MSF4800

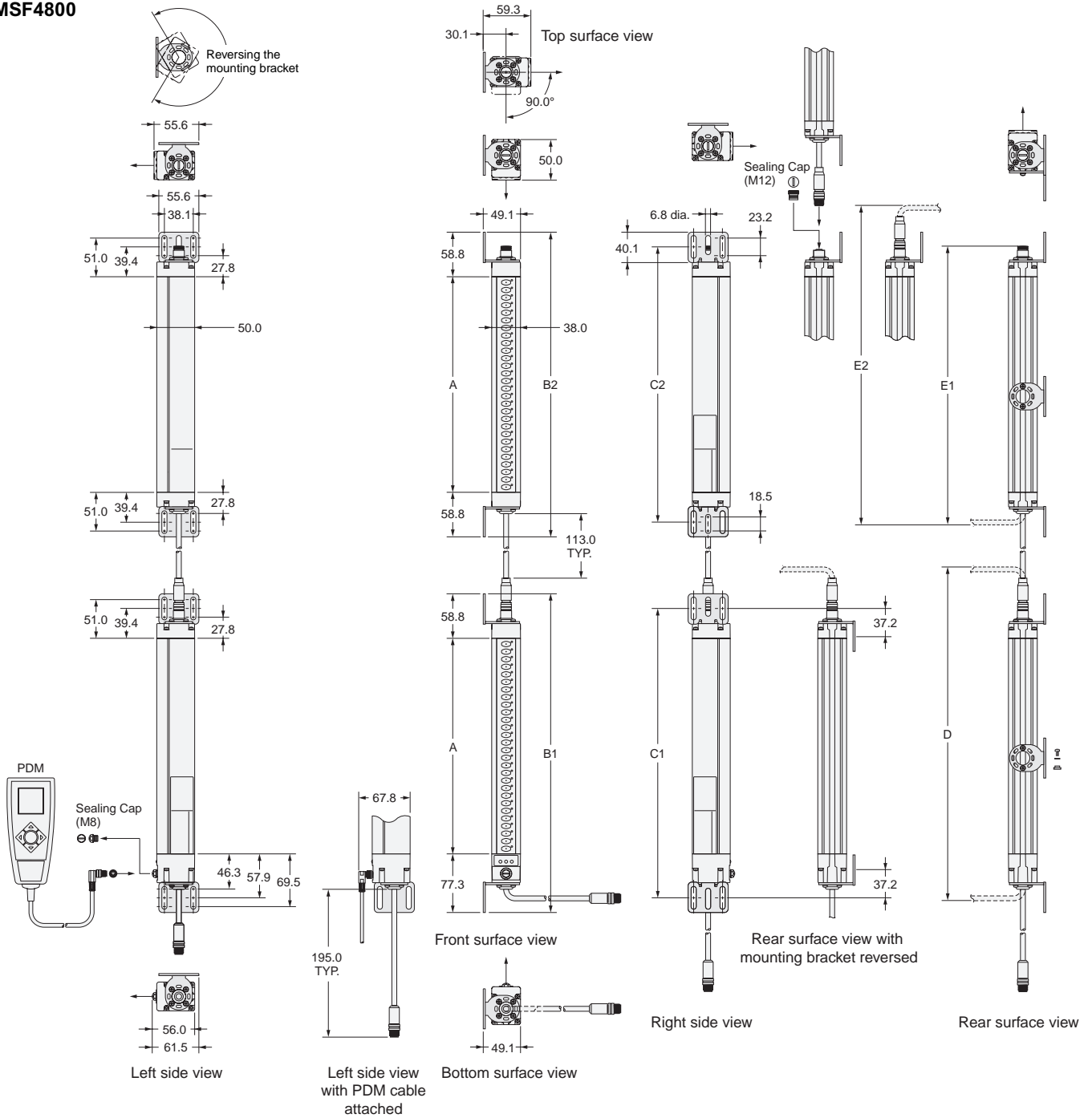

MSF4800-30 Transmitter and Receiver Dimensions

Dimensions Sensing area	A	B1	B2	C1	C2	D	E1	E2
240	244.6	380.6	362.1	341.9	323.3	400.2	327.9	381.6
280	284.4	420.4	401.9	381.7	363.1	440.0	367.7	421.4
320	324.8	460.8	442.3	422.1	403.5	480.4	408.1	461.8
360	364.5	500.5	482.0	461.8	443.2	520.1	447.8	501.5
400	404.2	540.2	521.7	501.5	482.9	559.8	487.5	541.2
440	443.9	579.9	561.4	541.2	522.6	599.5	527.2	580.9
480	484.3	620.3	601.8	581.6	563.0	639.9	567.6	621.3
520	523.4	659.4	640.9	620.7	602.1	679.0	606.7	660.4
560	563.7	699.7	681.2	661.0	642.4	719.3	647.0	700.7
600	604.1	740.1	721.6	701.4	682.8	759.7	687.4	741.1
640	643.9	779.9	761.4	741.2	722.6	799.5	727.2	780.9
680	683.6	819.6	801.1	780.9	762.3	839.2	766.9	820.6
720	724.0	860.0	841.5	821.3	802.7	879.6	807.3	861.0
760	763.0	899.0	880.5	860.3	841.7	918.6	846.3	900.0
800	803.5	939.5	921.0	900.8	882.2	959.1	886.8	940.5
840	843.8	979.8	961.3	941.1	922.5	999.4	927.1	980.8
880	882.8	1018.8	1000.3	980.1	961.5	1038.4	966.1	1019.8
920	922.5	1058.5	1040.0	1019.8	1001.2	1078.1	1005.8	1059.5
960	963.6	1099.6	1081.1	1060.9	1042.3	1119.2	1046.9	1100.6
1000	1002.6	1138.6	1120.1	1099.9	1081.3	1158.2	1085.9	1139.6
1040	1042.9	1178.9	1160.4	1140.2	1121.6	1198.5	1126.2	1179.9
1080	1083.9	1219.9	1201.4	1181.2	1162.6	1239.5	1167.2	1220.9
1120	1122.3	1258.3	1239.8	1219.6	1201.0	1277.9	1205.6	1259.3
1160	1162.7	1298.7	1280.2	1260.0	1241.4	1318.3	1246.0	1299.7
1200	1203.8	1339.8	1321.3	1301.1	1282.5	1359.4	1287.1	1340.8
1240	1242.1	1378.1	1359.6	1339.4	1320.8	1397.7	1325.4	1379.1
1280	1281.8	1417.8	1399.3	1379.1	1360.5	1437.4	1365.1	1418.8
1320	1323.6	1459.6	1441.1	1420.9	1402.3	1479.2	1406.9	1460.6
1360	1362.0	1498.0	1479.5	1459.3	1440.7	1517.6	1445.3	1499.0
1400	1401.7	1537.7	1519.2	1499.0	1480.4	1557.3	1485.0	1538.7
1440	1443.4	1579.4	1560.9	1540.7	1522.1	1599.0	1526.7	1580.4
1480	1481.8	1617.8	1599.3	1579.1	1560.5	1637.4	1565.1	1618.8
1520	1521.5	1657.5	1639.0	1618.8	1600.2	1677.1	1604.8	1658.5
1560	1563.3	1699.3	1680.8	1660.6	1642.0	1718.9	1646.6	1700.3
1600	1600.9	1736.9	1718.4	1698.2	1679.6	1756.5	1684.2	1737.9
1640	1641.3	1777.3	1758.8	1738.6	1720.0	1796.9	1724.6	1778.3
1680	1683.1	1819.1	1800.6	1780.4	1761.8	1838.7	1766.4	1820.1
1720	1720.8	1856.8	1838.3	1818.1	1799.5	1876.4	1804.1	1857.8
1760	1760.5	1896.5	1878.0	1857.8	1839.2	1916.1	1843.8	1897.5
1800	1802.9	1938.9	1920.4	1900.2	1881.6	1958.5	1886.2	1939.9
1840	1840.6	1976.6	1958.1	1937.9	1919.3	1996.2	1923.9	1977.6
1880	1880.3	2016.3	1997.8	1977.6	1959.0	2035.9	1963.6	2017.3
1920	1922.8	2058.8	2040.3	2020.1	2001.5	2078.4	2006.1	2059.8
1960	1960.4	2096.4	2077.9	2057.7	2039.1	2116.0	2043.7	2097.4
2000	2000.1	2136.1	2117.6	2097.4	2078.8	2155.7	2083.4	2137.1
2040	2042.6	2178.6	2160.1	2139.9	2121.3	2198.2	2125.9	2179.6
2080	2079.6	2215.6	2197.1	2176.9	2158.3	2235.2	2162.9	2216.6
2120	2120.0	2256.0	2237.5	2217.3	2198.7	2275.6	2203.3	2257.0

MSF4800-40 Transmitter and Receiver Dimensions

Dimensions Sensing area	A	B1	B2	C1	C2	D	E1	E2
360	364.5	500.5	482.0	461.8	443.2	520.1	447.8	501.5
480	484.3	620.3	601.8	581.6	563.0	639.9	567.6	621.3
600	604.1	740.1	721.6	701.4	682.8	759.7	687.4	741.1
720	724.0	860.0	841.5	821.3	802.7	879.6	807.3	861.0
840	843.8	979.8	961.3	941.1	922.5	999.4	927.1	980.8
960	963.6	1099.6	1081.1	1060.9	1042.3	1119.2	1046.9	1100.6
1080	1083.9	1219.9	1201.4	1181.2	1162.6	1239.5	1167.2	1220.9
1200	1203.4	1339.4	1320.9	1300.7	1282.1	1359.0	1286.7	1340.4
1320	1323.6	1459.6	1441.1	1420.9	1402.3	1479.2	1406.9	1460.6
1440	1443.4	1579.4	1560.9	1540.7	1522.1	1599.0	1526.7	1580.4
1560	1563.3	1699.3	1680.8	1660.6	1642.0	1718.9	1646.6	1700.3
1680	1681.3	1817.3	1798.8	1778.6	1760.0	1836.9	1764.6	1818.3
1800	1802.9	1938.9	1920.4	1900.2	1881.6	1958.5	1886.2	1939.9
1920	1922.8	2058.8	2040.3	2020.1	2001.5	2078.4	2006.1	2059.8
2040	2042.6	2178.6	2160.1	2139.9	2121.3	2198.2	2125.9	2179.6

Accessories

Cables with Connector on One End for Transmitter

- MS4800-CBLTX-10M (L = 10 m)
- MS4800-CBLTX-15M (L = 15 m)
- MS4800-CBLTX-30M (L = 30 m)

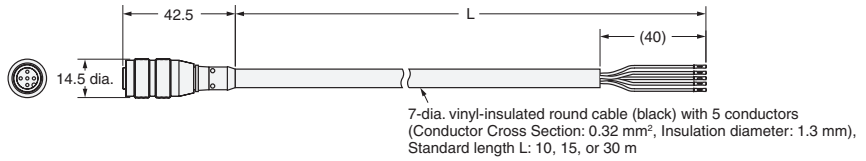

Cables with Connector on One End for Receiver

- MS4800-CBLRX-10M (L = 10 m)
- MS4800-CBLRX-15M (L = 15 m)
- MS4800-CBLRX-30M (L = 30 m)

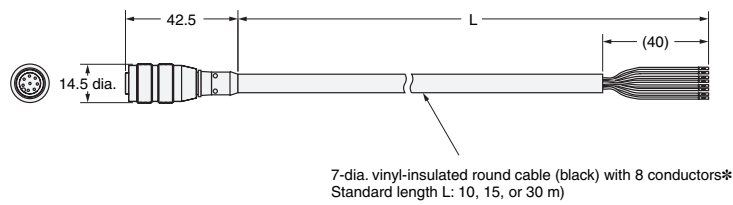

Wire color	Conductor cross sectional area (mm²)	Insulation outside diameter (mm)
Brown	0.52	1.6 dia.
Blue	0.52	1.6 dia.
Green	0.52	1.6 dia.
White	0.32	1.3 dia.
Yellow	0.2	1.2 dia.
Red	0.2	1.2 dia.
Pink	0.32	1.3 dia.
Black	0.32	1.3 dia.

Series Connection Cables for Transmitter

- MS4800-CBLTXIC-003M (L = 0.3 m)
- MS4800-CBLTXIC-005M (L = 0.5 m)
- MS4800-CBLTXIC-01M (L = 1 m)
- MS4800-CBLTXIC-02M (L = 2 m)
- MS4800-CBLTXIC-03M (L = 3 m)
- MS4800-CBLTXIC-05M (L = 5 m)
- MS4800-CBLTXIC-10M (L = 10 m)

Series Connection Cables for Receiver

- MS4800-CBLRXIC-003M (L = 0.3 m)
- MS4800-CBLRXIC-005M (L = 0.5 m)
- MS4800-CBLRXIC-01M (L = 1 m)
- MS4800-CBLRXIC-02M (L = 2 m)
- MS4800-CBLRXIC-03M (L = 3 m)
- MS4800-CBLRXIC-05M (L = 5 m)
- MS4800-CBLRXIC-10M (L = 10 m)

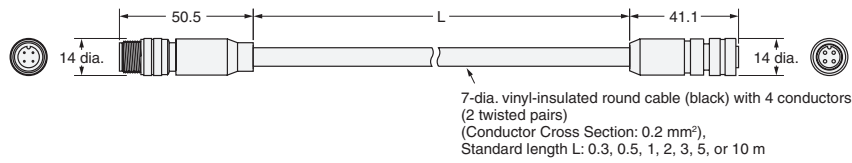

Mirrors

F39-MLG□

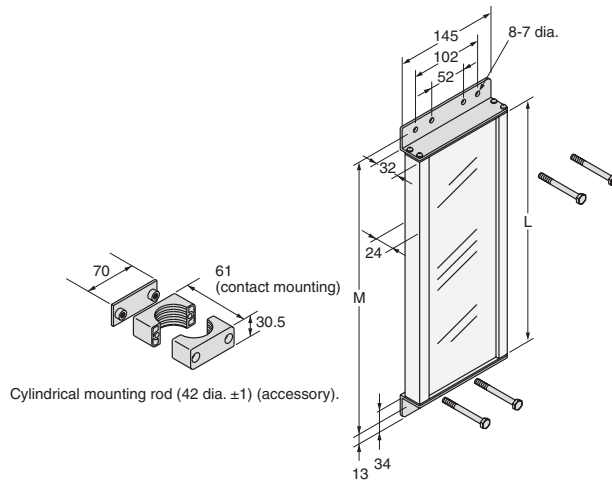

Model	L (mm)	M (mm)
F39-MLG0406	445	487
F39-MLG0610	648	690
F39-MLG0711	749	792
F39-MLG0914	953	995
F39-MLG1067	1,105	1,148
F39-MLG1219	1,257	1,300
F39-MLG1422	1,461	1,503
F39-MLG1626	1,664	1,706
F39-MLG1830	1,867	1,910
F39-MLG2134	2,172	2,214

Resource Module

MS4800-RM6

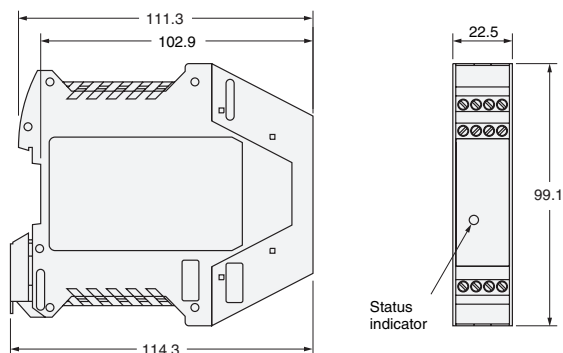

Safety Precautions

This document is intended as a guide for product selection. Be sure to read the *Instruction Manual* provided with the product for actual operation.

Regulations and Standards

1. Application of an MS/MSF4800-series Safety Light Curtain alone cannot receive type certification provided by Article 44-2 of the Industrial Safety and Health Law of Japan. It is necessary to apply the Curtain in a system. Therefore, when using the MS/MSF4800-series Safety Light Curtain in Japan as a "safety device for presses or shearing machines" prescribed in Article 42 of that law, the system must receive type certification.
2. The MS/MSF4800-series Safety Light Curtain is electro-sensitive protective equipment (ESPE) in accordance with European Union (EU) Machinery Directive Index Annex IV, B, Safety Components, Item 1.
3. The MS/MSF4800-series Safety Light Curtain complies with the following legislation and standards:
 - (1) EU Regulations
Machinery Directive: Directive 2006/42/EC
EMC Directive: Directive 2004/108/EC
 - (2) European standards:
EN 61496-1 (TYPE 4 ESPE)
CLC/TS61496-2 (TYPE 4 AOPD)
EN 61508-1 to -7 (SIL3)
EN ISO 13849-1: 2008 (Category 4/PLe)
EN 62061, EN 50178, EN60204-1
 - (3) International standards:
IEC 61496-1 (TYPE 4 ESPE)
IEC 61496-2 (TYPE 4 AOPD)
EN 61508-1 to -7 (SIL3)
 - (4) JIS standards:
JIS B9704-1 (TYPE 4 ESPE)
JIS B9704-2 (TYPE 4 AOPD)
 - (5) North American standards:
UL 61496-1 (Type 4 ESPE)
UL 61496-2 (Type 4 AOPD)
UL 508, UL 1998, CAN/CSA 22.2 No. 14
CAN/CSA 22.2 No. 0.8
4. The MS/MSF4800 received the following certification from TÜV Rheinland, an EU-accredited body:
 - EC type test based on Machinery Directive
Type 4 ESPE (IEC 61496-1)
Type 4 AOPD (IEC 61496-2)
 - TÜV Rheinland type certification
Type 4 ESPE (IEC 61496-1)
Type 4 AOPD (IEC 61496-2)
 - SIL3 (IEC 61508)
Category 4/PLe (EN ISO 139849-1: 2008)
5. The MS/MSF4800 has received certificates for UL listing for US and Canadian safety standards from UL, a third party assessment body.
 - Type 4 ESPE (UL 61496-1)
Type 4 AOPD (UL 61496-2)
6. The MS/MSF4800 is designed according to the standards listed below. To make sure that the final system complies with the following standards and regulations, you are asked to design and use it in accordance with all other related standards, laws, and regulations.
If you have any questions, consult with UL or other specialized organizations.
 - European standards: EN 415-4, EN 692, EN 693
 - US Occupational Safety and Health Administration: OSHA 29 CFR 1910.212
 - US Occupational Safety and Health Administration: OSHA 29 CFR 1910.217
 - American National Standard Institute: ANSI B11.1 to B11.19
 - American National Standard Institute: ANSI/RIA 15.06
 - Canadian Standards Association: CSA Z142, Z432, Z434
 - SEMI standard SEMI S2

Precautions for Safe Use

Indications and Meanings for Safe Use

To ensure safe use of the MS/MSF4800, signal words and an alert symbol are used in this document to indicate safety-related instructions. These instructions describe details very important to your safety. It is extremely important that you understand and follow the instructions. The signal words and alert symbol used in this document are shown below.

 WARNING	<p>Indicates a potentially hazardous situation which, if not avoided, will result in minor or moderate injury, or may result in serious injury or death. Additionally, there may be significant property damage.</p>
--	--

Meaning of Symbol

	<p>General Prohibition Indicates a general prohibition</p>
---	---

Warning Indications

 WARNING
--

The MS/MSF4800 is a safety area sensor that is designed to protect operators who work in hazardous environments, such as those containing operating machinery.

MS/MSF4800 safety levels for specific applications and installation conditions can be attained only by achieving safe usage, installation, maintenance, and operation of the MS/MSF4800. These factors must be thoroughly confirmed by the customer who purchased the MS/MSF4800, as well as installers and employers.

Precautions for Users

 WARNING
--

The MS/MSF4800 must be installed, set, and integrated into the mechanical control system by a qualified technician who has received the appropriate training. Installation by an unqualified person may prevent the MS/MSF4800 from operating correctly, with the result that people may go undetected, and serious injuries may occur.

When changing parameters with the Programming and Diagnostics Module, the change must be made and the contents of the change must be managed by the person in charge of the system. Unintentional or mistaken parameter changes may prevent detection of people and result in serious injury.

The manager of the system is responsible for the selection and training of personnel to properly install, operate, and maintain the machine and its safeguarding systems.

The MS/MSF4800 must be installed, verified, and maintained by a qualified person. A qualified person is defined as someone who holds credentials or certification proving that he or she has received relevant

professional training, or someone whose ability to solve problems related to the specific matters or operations at hand has been verified by considerable knowledge, training or considerable experience. (See ANSI/PMMI B155.1-2006 for details.)

Machine Installation

 WARNING
--

Do not use this sensor for machines that cannot possibly be quickly stopped by electrical controls. For example, do not use it for a pressing machine that uses a full-rotation clutch. Otherwise, the machine may not stop before a person reaches the hazardous part, resulting in serious injury.

Do not use the auxiliary output for safety applications. Failure of the MS/MSF4800 may cause a person to go undetected, resulting in serious injury.

The guarded machine must not present a hazard from flying parts.

The guarded machine must have a consistent stopping time and adequate control mechanisms.

All safety-related machine control elements must be designed so that a failure in the control logic or a failure in the control circuit does not lead to danger.

Additional guarding may be required for access to dangerous areas not covered by the MS/MSF4800 system.

For Mounting

 WARNING
--

Be sure to test the operation of the MS/MSF4800 after installation with the machine in a non-operating condition to verify that the MS/MSF4800 operates as intended. Unintended function settings may cause a person to go undetected, resulting in serious injury.

Be sure to secure the safety distance between the MS/MSF4800 and the hazardous parts. Otherwise, the machine may not stop before a person reaches the hazardous part, resulting in serious injury.

Install a protective structure so that the hazardous part of a machine can only be reached by passing through the sensor's detection zone. Install the sensors so that part of the person is always present in the detection zone when working in a machine's hazardous areas. If a person is able to step into the hazardous area of a machine and remain behind the MS/MSF4800's detection zone, configure the system with an interlock function that prevents the machine from being restarted. Otherwise it may result in heavy injury.

When using Start/Restart Interlock Mode, install the interlock reset switch in a location that provides a clear view of the entire hazardous area and where it cannot be activated from within the hazardous area.

The MS/MSF4800 cannot protect a person from an object flying from a hazardous area. Install protective cover(s) or fence(s).

When detection of an area has been disabled by the fixed blanking function, provide a protective structure around the entire area that will prevent a person from passing through it and reaching the hazardous part of the machinery. Failure to do so may prevent detection of people and result in serious injury.

After setting the fixed blanking function, be sure to confirm that a test rod is detected within all areas that require detection. Failure to do so may prevent detection of people and result in serious injury.

When the fixed blanking, floating blanking, monitored blanking, or reduced resolution blanking function is used, the diameter for the minimum detectable object becomes larger. Be sure to use the diameter for the minimum detectable object for the fixed blanking, floating blanking, monitored blanking, or reduced resolution blanking function when calculating the safety distance. Failure to do so may prevent the machinery from stopping before a person reaches the hazardous part of the machinery, and result in serious injury.

The muting and override functions disable the safety functions of the device. Additional safety measures must be taken to ensure safety while these functions are working.

Muting lamps that indicate the state of the muting and override functions must be installed where they are clearly visible to workers from all the operating positions.

Install Muting Sensors so that they can distinguish between the object that is being allowed to be passed through the detection zone and a person. If the muting function is activated by the detection of a person, it may result in serious injury.

Muting times must be precisely set according to the application by qualified personnel who have received appropriate training. In particular, if the muting time limit is to be set to infinity, the person who makes the setting must bear responsibility.

Use two independent input devices for the muting inputs.

Install the MS/MSF4800, Muting Sensors, or a protective wall so that workers cannot enter hazardous areas while muting is in effect, and set muting times.

Position the switch that is used to activate the override function in a location where the entire hazardous area can be seen, and where the switch cannot be operated from inside the hazardous area. Make sure that nobody is in the hazardous area before activating the override function.

Install the MS/MSF4800 so that it is not affected by reflective surfaces. Failure to do so may hinder detection, resulting in serious injury.

When using more than one set of MS/MSF4800, install them so that mutual interference does not occur, such as by configuring series connections, using physical, light-blocking barriers, or changing scan codes between adjacent sets.

Make sure that the MS/MSF4800 is securely mounted and its cables and connectors are properly connected.

Make sure that no foreign material, such as water, oil or dust, enters the MS/MSF4800 or connectors while caps are removed.

Do not use the sensor system with mirrors in a retro-reflective configuration as shown in the following diagram. Doing so may hinder detection. It is possible to use mirrors to “bend” the detection zone to a 90-degree angle.

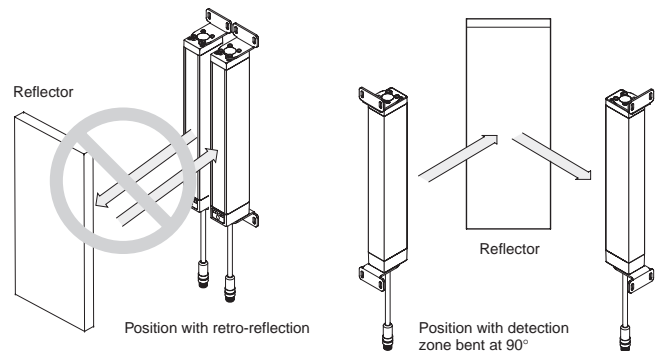

Inspect all MS/MSF4800 systems as instructed in the *Mini Safe 4800 Series Light Curtains Installation and Operating Manual*. When using series connections, perform inspection of all connected MS/MSF4800 Curtains as instructed in the Manual.

Recalculate the safety distance whenever the response time has been changed.

Conduct all tests and repairs with the procedures given in the *Mini Safe 4800 Series Light Curtains Installation and Operating Manual*.

Conduct the test procedures given in the *Mini Safe 4800 Series Light Curtains Installation and Operating Manual* according to the periodic inspection system established by the employer. These test procedures must be conducted after performing maintenance, changing tools, setting up the system, making adjustments, or otherwise making changes to the MS/MSF4800 or the guarded machine. When more than one operator uses the guarded machine, or when the guarded machine is used in shifts, it is recommended that these test procedures be conducted after each operation change or shift change. It is necessary to confirm that the MS/MSF4800 and the safety system of the guarded machine function properly and that the machine stops as intended. If the test results in failure, there is a strong possibility that a serious accident could occur involving an operator.

Wiring Precautions

 **WARNING**

For an PNP output, connect the load between the output and 0 V line. Connecting the load between the output and +24 V line results in a dangerous condition because the operation mode is reversed to “ON when light is interrupted.”

Do not interconnect an output line with the +24-V line. Otherwise, the output is always ON, creating a dangerous situation. Also, 0 V of the power supply must be grounded so that output does not turn ON due to grounding of the output line.

Configure the system by using the optimal number of control outputs that satisfy the requirements of the necessary safety category.

Do not connect the lines of the MS/MSF4800 to a DC power supply higher than 24 VDC +20%. Also, do not connect to an AC power supply. Otherwise, it may result in electric shock.

For the MS/MSF4800 to comply with IEC 61496-1 and UL 508, the DC power supply unit must satisfy all of the following conditions:

- Must be within rated power voltage (24 VDC ±20%).
- Must have tolerance against the total rated current of devices if it is connected to multiple devices.
- Must comply with EMC directives (industrial environment).
- Double or enhanced insulation must be applied between the primary and secondary circuits.
- Automatic recovery must be possible for overcurrent protection.
- Output holding time must be 20 ms or longer.
- Must satisfy output characteristic requirements for class 2 circuit or limited voltage current circuit defined by UL508.
- Must comply with the EMC, laws, and regulations of the country or region where the MS/MSF4800 is used. (For example, in the EU, the power supply must comply with the EMC Low Voltage Directive.)

Double or enhanced insulation from hazardous voltage must be applied to all input and output lines. Failure to do so may result in electric shock.

The cable extension length must be no greater than the specified length. Otherwise, the safety functions may fail to work properly, resulting in danger.

Other Precautions

 **WARNING**

To use the MS/MSF4800 in PSDI Mode (i.e., restarting cycle operation by the sensor), you must configure an appropriate control circuit between the MS/MSF4800 and the machine. For details about PSDI, refer to ANSI RIA 15.06-1999, OSHA 1910.217 (h), ANSI B11.2-1995 (R2005), and other relevant standards and regulations.

Do not try to disassemble, repair, or modify this product. Doing so may cause the safety functions to stop working properly.

Do not use the MS/MSF4800 in environments where flammable or explosive gases are present. Doing so may result in explosion.

Perform daily and 6-month inspections for the MS/MSF4800. Otherwise, the system may fail to work properly, resulting in serious injury.

Safety Distance

 **WARNING**

Be sure to secure the safety distance between the MS/MSF4800 and the hazardous part. Otherwise, the machine may not stop before a person reaches the hazardous part, resulting in serious injury.

Note: The response time of a machine is the time period from when the machine receives a stop signal to when the machine's hazardous part stops. Measure the response time on the actual system. Also, periodically check that the response time of the machine has not changed.

How to Calculate the Safety Distance Specified by International Standard ISO 13855-2002 (European Standard EN 999-1999) (Reference)

The following explanation is based on standard EN 999. This standard applies to Safety Light Curtains used in an industrial environment.

Systems with a Detection Capability of 40 mm Max.

Use the following calculation for a system that detects objects with a minimum detectable diameter of 40 mm max.

$$S = (K \times T) + C$$

Where,

S: The shortest distance (in mm) between the hazardous part and the detection point (edge, surface, or area).

$$K = 2000 \text{ mm/s}$$

T: The time (in seconds) required to stop the entire system.

$$T = t_1 + t_2$$

t1: The response time (in seconds) of the Safety Light Curtain. This response time is listed in the **Response Time** on page 15.

t2 = Maximum time (in seconds) required to stop the machine.

$$C = 8 (d - 14 \text{ mm}), \text{ however, this must be 0 or more.}$$

d: Minimum detectable object (in mm) of the MS/MSF4800.

The following calculation is given as an example:

$$S = (2000 \text{ mm/s} \times T) + 8 (d - 14 \text{ mm})$$

This calculation applies to all shortest distance S values to 500 mm max. The S value must be 100 mm min.

If the above-described calculation results in an S value greater than 500 mm, use the following calculation:

For this calculation the S value must be 500 mm min.

$$S = (1600 \text{ mm/s} \times T) + 8 (d - 14 \text{ mm})$$

Systems with a Detection Capability Greater Than 40 mm

Use the following calculation for a system that detects objects with a minimum detectable diameter greater than 40 mm.

$$S = (K \times T) + C$$

Where,

S: The shortest distance (in mm) between the hazardous part and the detection point (edge, surface, or area).

$$K = 1600 \text{ mm/s}$$

T: The time (in seconds) required to stop the entire system.

$$T = t_1 + t_2$$

t₁: The response time (in seconds) of the Safety Light Curtain. This is given in the **Response Time** on page 15.

t₂: Maximum time (in seconds) required to stop the machine.

$$C = 850 \text{ mm}$$

The following calculation is given as an example:

$$S = (1600 \text{ mm/s} \times T) + 850 \text{ mm}$$

How to Calculate the Safety Distance Specified by American Standard ANSI B11.19 (Reference)

If a person approaches the detection zone of the MS/MSF4800 perpendicularly, calculate the safety distance as shown below.

$$Ds = K \times (Ts + Tc + Tr + Tbm) + Dpf$$

Where,

Ds: Safety distance (in inches)

K: Approach speed to the detection zone (in inches)

Assuming that the operator is beginning to perform a manual task, the ANSI standard value for K is 63 inches/second. ANSI B11.19-2003 requires that the following factors be considered in determining the K value.

- a. Movement of hands or arms
- b. Twisting of the body or shoulder, or bending of the waist
- c. Walking or running

Use the above-described factors to determine the approach speed for the actual application.

Ts: The time (in seconds) required to stop the machine.

Tc: The maximum response time (in seconds) of the machine's control circuit required to activate the braking device of the machine.

Note: Ts + Tc are normally measured simultaneously by a device for measuring the time required for stopping.

Tr: The response time (in seconds) for the MS/MSF4800.

This is given in the **Response Time** on page 15.

Tbm: The stopping time (in seconds) added by a brake monitor before determining degradation in the machine stopping time.

If a machine has a brake monitor, "Tbm = Brake monitor setting time – (Ts + Tc)." If it has no brake monitor, it is necessary to increase the value added to the machine's stopping time somewhat to account for brake wear. For details, consult the manufacturer of the machine.

The depth penetration factor (Dpf) is related to the minimum detectable object diameter of the MS/MSF4800. Determine the minimum detectable object diameter (S) and the model number of the MS/MSF4800 that is being used, then obtain the Dpf directly from the following table, *Examples of Minimum Detectable Object (S), Additional Safety Distance (C), and Dpf.*

Examples of Minimum Detectable Object (S), Additional Safety Distance (C), and Dpf

Model	Total number of beams disabled by fixed or floating blanking	Minimum detectable object diameter: S (mm)	Additional safety distance obtained by ISO 13855-2002 (European standard EN 999-1999) calculation: C (mm) C = 8 (S – 14)	Depth penetration factor using the ANSI calculation (Dpf) Dpf = 3.4 (S – 0.276) inches
MS/MSF4800-30	None	30	128	3.1 inches (78 mm)
	1	50	850 (for S = 40 mm min.)	5.76 inches (146 mm)
	2 or more	Greater than 64		36 inches (900 mm)
MS/MSF4800-40	None	40	850 (for S = 40 mm min.)	4.4 inches (112 mm)
	1 or more	Greater than 64		36 inches (900 mm)

Installation

Reflective Surface Interference

⚠ WARNING

Install the MS/MSF4800 where it will not be affected by reflective surfaces. Failure to do so may prevent detection and result in serious injury.

There is a possibility that reflective surfaces next to the sensing area may reflect light and prevent the detection of beam interruption due to obstacles within the area (refer to Figs. 1 to 5). Reflective surfaces may exist on parts of machinery, mechanical protective devices, or products. The minimum distance (d) must be set between the reflective object and the beam centerline of the MS/MSF4800 sensing area.

For information on how to test this condition, refer to the *Mini Safe 4800 Series Light Curtains Installation and Operating Manual*.

Fig. 1 Example of Correct Installation with Proper Placement

The interruption of the beam due to the obstacle is accurately detected. The reflective object is outside the directional angle.

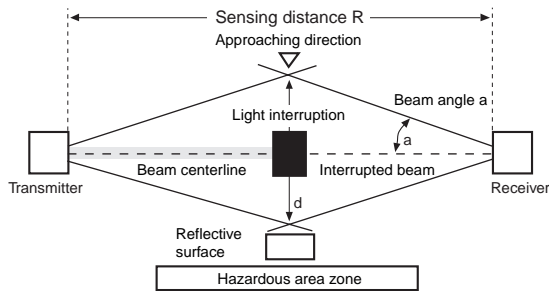

Fig. 2 Example of Unsafe Installation

Reflection prevents the obstacle from being detected. The reflective object is inside the beam angle.

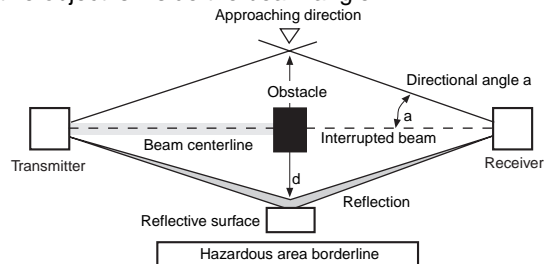

Fig. 3 Example of Unsafe Installation

The interruption of the beam due to the obstacle is not detected because of reflection. Reflective surface interference can occur from either above or below the sensing area.

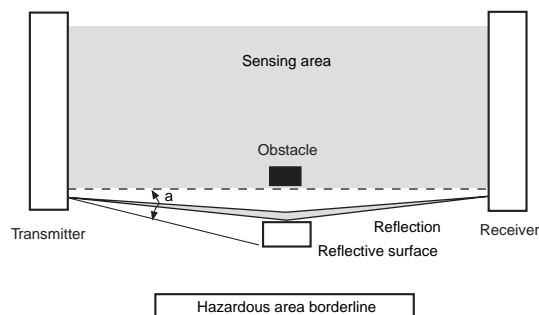

Fig. 4 Worst Placement Example

This example shows the minimum distance d from the reflective surface to one of the beam centerlines.

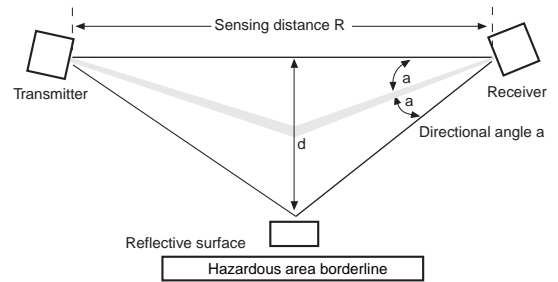
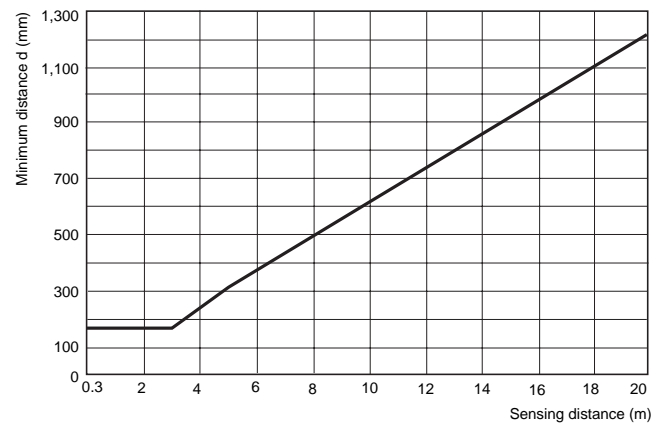

Fig. 5 Sensing Distance vs. Minimum Distance from the Reflective Surface



Prevention of Mutual Interference

⚠ WARNING

Do not use the sensor system with mirrors in a retro-reflective configuration. Doing so may hinder detection. It is possible to use mirrors to change the route of the light.

When using more than 1 set of MS/MSF4800, install them so that mutual interference does not occur, such as by configuring a series connection or using physical barriers between adjacent sets.

The MS/MSF4800 is equipped with two scan codes, A and B, to reduce mutual interference from other Safety Light Curtains. The Transmitter and Receiver must both be set to the same scan code to enable the Receiver to change to Machine Run State.

Basic Installation Precautions

WARNING

Install a protective structure so that the hazardous part of a machine can only be reached by passing through the sensor's detection zone. Install the sensors so that part of the person is always present in the detection zone when working in a machine's hazardous areas. If a person is able to step into the hazardous area of a machine and remain behind the MS/MSF4800's detection zone, configure the system with an interlock function that prevents the machine from being restarted. Otherwise it may result in heavy injury.

Do not use this sensor for machines that cannot possibly be quickly stopped by electrical controls. For example, do not use it for a pressing machine that uses a full-rotation clutch. Otherwise, the machine may not stop before a person reaches the hazardous part, resulting in serious injury.

Using the MS/MSF4800 in Presence Sensing Device Initiation (PSDI) Mode, which is used to restart machine cycle operation, requires that an appropriate control circuit be configured between the MS/MSF4800 and the guarded machine. For details on PSDI, refer to related standards and regulations, including ANSI RIA 15.06-1999, OSHA 1910.217(h), and ANSI B11.2-1995 (R2005).

When using the Start/Restart Interlock Mode, install the interlock reset switch in a location that provides a clear view of the entire hazardous area and where it cannot be activated from within the hazardous area.

Do not use the MS/MSF4800 in environments where flammable or explosive gases are present. Doing so may result in explosion.

The MS/MSF4800 cannot protect a person from an object flying from a hazardous area. Install protective cover(s) or fence(s).

Make sure that the MS/MSF4800 is securely mounted and its cables and connectors are properly connected.

Be sure to test the operation of the MS/MSF4800 after installation with the machine in a non-operating condition to verify that the MS/MSF4800 operates as intended. Unintended function settings may cause a person to go undetected, resulting in serious injury.

Additional Protection

It is necessary to use an appropriate means, such as a fixed barrier guard, interlock guard, or safety mat, to protect areas that provide access to any hazardous areas of a machine that are not protected by the MS/MSF4800. See the examples in the following diagram.

Correct Safety Light Curtain Installation Examples

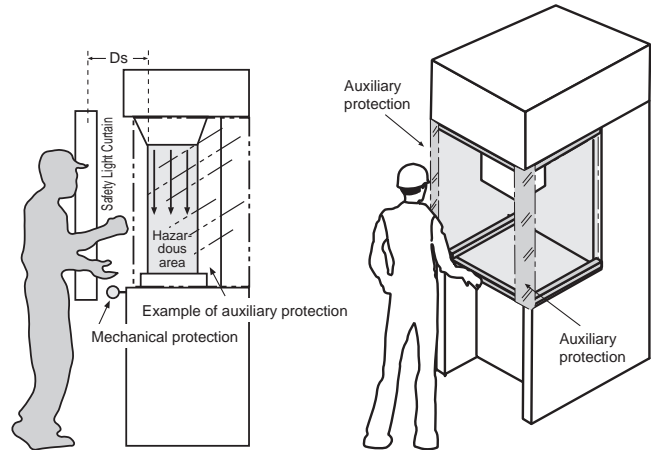

Adding Mechanical Protection to the MS4800

Three-directional MSF4800 Protection

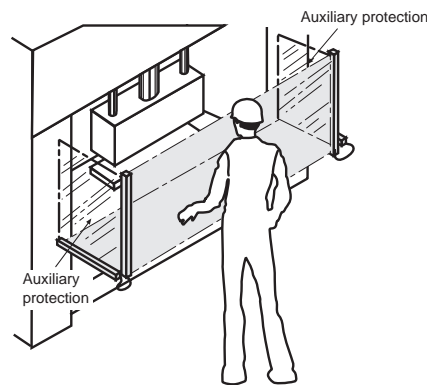

Two-axis MSF4800 Protection

Strengthening Rigidity during Installation

To increase rigidity, it is recommended that mounting brackets be added when installing an MS/MSF4800 system that has a length of 1,000 mm or more. Use the T-slot groove on the back of the MS/MSF4800 to install the mounting brackets to the rear surfaces of both the Transmitter and Receiver.

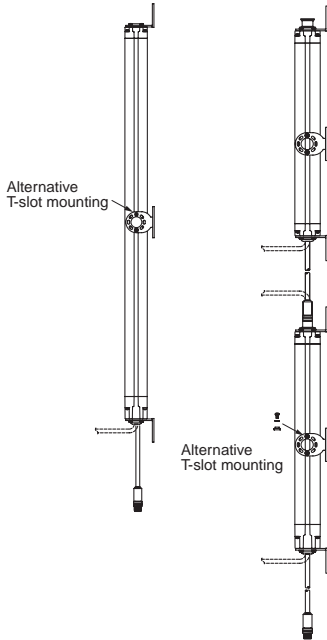

Note: When the alternate T-slot mounting is used to secure the MS/MSF4800, the mounting bracket can no longer be used to adjust the beams.

Installing Multiple Systems

When installing two or more MS/MSF4800 systems with the same scan code in a line in close proximity, measures must be taken to prevent mutual interference between the systems. This problem can be solved by positioning Transmitters and Receivers back-to-back, or by stacking the systems.

Staggering Positions When Installing Multiple Safety Light Curtains

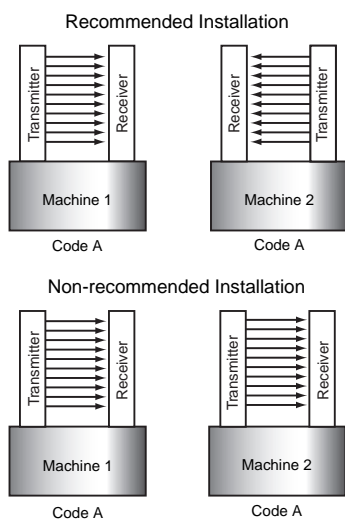

The MS/MSF4800 scan code function can also be used to install multiple systems in a line in close proximity. Special coding for the light beams allows unique system operation,

and can be used with other systems possessing different scan codes. The MS/MSF4800 is equipped with two scan codes.

Setting the Scan Codes When Installing Multiple Safety Light Curtains

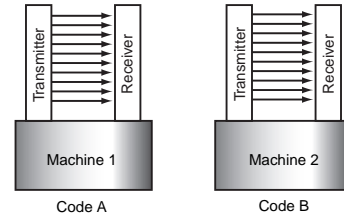

● **Sensing Area**

The sensing area of the MS/MSF4800 can be delineated by drawing lines from the inside edges of the End Caps on the Transmitter and Receiver. The area outside these lines is not sensed. Install the MS/MSF4800 so that it is not possible to enter the hazardous area without passing through the sensing area.

● **Installation Adjustment**

The installation adjustment for the Transmitter and Receiver is easiest when the system is in Auto Start Mode with the fixed blanking function disabled. Install the Transmitter and Receiver at the same height, on the same flat surface. The individual beam indicators (IBI) will turn ON when the beams are not aligned. For details, refer to *Individual Beam Indicators (IBI)* on page 22.

● **Input Power Supply Requirements**

The MS/MSF4800 operates at 24 VDC ±20%. The power supply for the MS/MSF4800 must satisfy the momentary power interruption and voltage drop requirements of IEC 61496-1 (4.3.2.2, 5.4.3.2) and IEC 60204-1 (4.3.3). Use the OMRON power supply with STI Parts No. 42992 or equivalent.

● **Peripheral Protection Requirements**

For peripheral protection, install the MS/MSF4800 so that its sensing area is outside the periphery of the guarded machine or robot. This installation method can be used to provide space for the operator to stand between the sensing area and the hazardous area. In this configuration, the guarded machine must be restartable only by using a key switch, and the key switch must be outside the hazardous operation area, in a location where the entire hazardous area is visible. Start/Restart Interlock Mode is well suited to peripheral protection applications.

● **Minimum Detectable Object Diameter Indication**

The serial number labels on the Transmitter and Receiver have marks for four minimum detectable object diameters. When installing the MS/MSF4800, use an oil-based marking pen to cross out the minimum detectable object diameters that were not set. The minimum detectable object diameter differs when floating blanking is not used and when floating blanking is set for one or two beams. For details, refer to the *Mini Safe 4800 Series Light Curtains Installation and Operating Manual*.

● **Sensor Restart of Machine Cycle Operation (PSDI)**

Using the Safety Light Curtain to initiate a machine cycle after an object is removed from the sensing area is called Presence Sensing Device Initiation (PSDI). Use of PSDI places additional requirements on the guarding and safety controls. It can restrict advanced Safety Light Curtain features such as floating blanking and fixed blanking. Details on PSDI can be found in ANSI RIA 15.06-1999, OSHA 1910.217(h), and ANSI B11.2-1995 (R2005).

For Wiring

⚠ WARNING

For PNP output, connect the load between the output and 0 V line. Connecting the load between the output and +24 V line results in a dangerous condition because the operation mode is reversed to “ON when light is interrupted.”

Do not interconnect an output line with a +24-V line. Otherwise, the output is always ON, creating a dangerous situation. Also, 0 V of the power supply must be grounded so that output does not turn ON due to grounding of the output line.

Configure the system by using the optimal number of control outputs that satisfy the requirements of the necessary safety category.

Do not connect the lines of the MS/MSF4800 to a DC power supply higher than 24 V +20%. Also, do not connect to an AC power supply. Otherwise, it may result in electric shock.

Programming and Diagnostics Module

The MS/MSF4800-series Safety Light Curtains require the use of a Programming and Diagnostics Module (PDM) to program the operating parameters of the Light Curtain. In addition to Safety Light Curtain configuration, this Module also serves as a diagnostics device, allowing the user to retrieve fault information.

- Displays programming and diagnostics information on a multi-line LCD display.
- Supports English and Japanese languages. To switch between English and Japanese, continue to press the right Forward/Backward Scroll Button more than ten times at the log-in screen that appears after the PDM is connected to the MS/MSF4800.
- The housing is rated IP65, allowing permanent mounting near the Safety Light Curtain.

Note: The light curtain does not require the PDM to operate. The factory default settings allow for basic guarding operation.

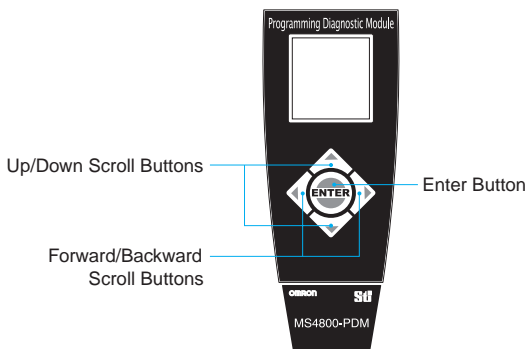

For the MS/MSF4800 to comply with IEC 61496-1 and UL 508, the DC power supply unit must satisfy all of the following conditions:

- Must be within rated power voltage (24 VDC ±20%).
- Must have tolerance against the total rated current of devices if it is connected to multiple devices.
- Must comply with EMC directives (industrial environment).
- Double or enhanced insulation must be applied between the primary and secondary circuits.
- Automatic recovery must be possible for overcurrent protection.
- Output holding time must be 20 ms or longer.
- Must satisfy output characteristic requirements for class 2 circuit or limited voltage current circuit defined by UL508.
- Must comply with the EMC, laws, and regulations of the country or region where the MS/MSF4800 is used. (For example, in the EU, the power supply must comply with the EMC Low Voltage Directive.)

Double or enhanced insulation from hazardous voltage must be applied to all input and output lines. Failure to do so may result in electric shock.

The cable extension length must be no greater than the specified length. Otherwise, the safety functions may fail to work properly, resulting in danger.

PDM Navigation Buttons

Name	Shape	Description
Forward/Backward Scroll Buttons		Scroll forward and backward to review the previous and next menu, or to move within the same screen.
Up/Down Scroll Buttons		Scroll up and down to review the selection of the current menu.
Enter Button		When pressed the selected function will be accessed.

Note: For information on the operating method, refer to the *Mini Safe 4800 Series Safety Light Curtains Installation and Operating Manual*.

OMRON Corporation Industrial Automation Company

Tokyo, JAPAN

Contact: www.ia.omron.com

Regional Headquarters

OMRON EUROPE B.V.

Wegalaan 67-69-2132 JD Hoofddorp
The Netherlands

Tel: (31)2356-81-300/Fax: (31)2356-81-388

OMRON SCIENTIFIC TECHNOLOGIES INC.

6550 Dumbarton Circle, Fremont
CA 94555-3605 U.S.A.

Tel: (1) 510-608-3400/Fax: (1) 510-744-1442

OMRON ASIA PACIFIC PTE. LTD.

No. 438A Alexandra Road # 05-05/08 (Lobby 2),
Alexandra Technopark,
Singapore 119967

Tel: (65) 6835-3011/Fax: (65) 6835-2711

OMRON (CHINA) CO., LTD.

Room 2211, Bank of China Tower,
200 Yin Cheng Zhong Road,
PuDong New Area, Shanghai, 200120, China
Tel: (86) 21-5037-2222/Fax: (86) 21-5037-2200

Authorized Distributor:

© OMRON Corporation 2009 All Rights Reserved.
In the interest of product improvement,
specifications are subject to change without notice.

CSM_7_1_0214
Cat. No. F084-E1-01

Printed in Japan
0408-3M (0408) (C)