

Pushbutton Switches/Pilot Lights

A16/M16

Mounting Aperture of 16 mm

- Modular construction (Pushbutton + Case + Lamp + Switch Unit)
- “Snap-in” switch unit for quick and easy, tool-free assembly
- Wide range of switching capacity from general to microload
- High reliability IP65 or IP40 models
- Short mounting depth, less than 28.5 mm below panel
- Terminal layout simplifies common wiring
- UL and CSA approved, VDE (pending)
- Conforms to EN60943-5-1, IEC947-5-1



Ordering Information

CONSTRUCTION

Flange Shape

- Rectangular (A16□-J)
- Square (A16□-A)
- Round (A16□-T)

Available Colors

- For LED/incandescent
Red, green, yellow, white, blue
 - For non-illuminated
Red, green, yellow, white, blue, black
- (Actual color of yellow pushbuttons more closely resembles amber than true yellow.)

Protective Case and Terminal Type

- **Protective Structure**
IP40/Oil-resistant IP65
- **Terminal Type**
Solder terminals
(tab terminals #110)

Lamp

- LED
- Incandescent lamp

Switch Unit Specifications

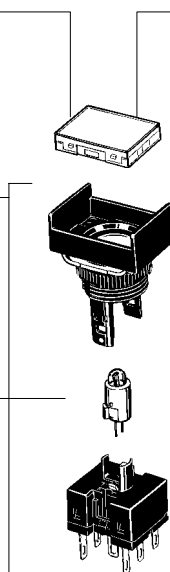

- **Ratings**
125 VAC: 5 A
250 VAC: 3 A
30 VDC 3 A
Minimum applicable load: 1 mA at 5 VDC



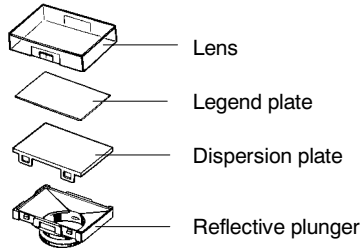

Structure of Pushbutton

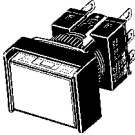
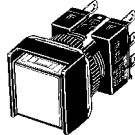

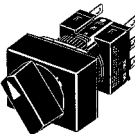
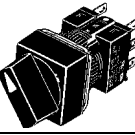
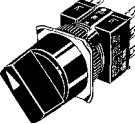
MODELS

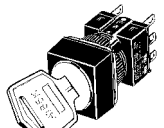
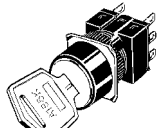
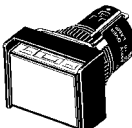
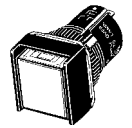
| Item | Shape | | Part number |
|-----------------------------|-------------|--|--|
| Pushbutton Switches | Rectangular |  | A16-J A165-J |
| | Square |  | A16-A A165-A |
| | Round |  | A16-T A165-T |
| Knob-type Selector Switches | Rectangular |  | A165S-J (Non-illuminated) A165W-J (Illuminated) |
| | Square |  | A165S-A (Non-illuminated) A165W-A (Illuminated) |
| | Round |  | A165S-T (Non-illuminated) A165W-T (Illuminated) |

| Item | Shape | | Part number |
|----------------------------|-------------|---|-------------------|
| Key-type Selector Switches | Rectangular |  | A165K-J |
| | Square |  | A165K-A |
| | Round |  | A165K-T |
| Pilot Lights | Rectangular |  | M16-J M165-J |
| | Square |  | M16-A M165-A |
| | Round |  | M16-T M165-T |
| Emergency Stop Switches | |  | A165E |
| Buzzers | |  | M2BJ-B M2BJ-BH |

■ PART NUMBER LEGEND A16 NON-ILLUMINATED PUSHBUTTONS (COMPLETE ASSEMBLY)

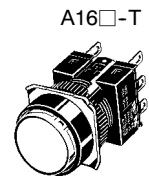
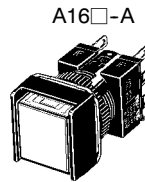
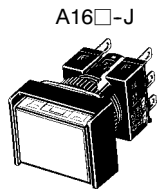

A16 Part number nomenclature

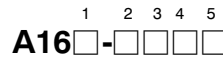

1 Enclosure Rating

| Code | Description |
|------|--------------------|
| None | IP40 |
| 5 | IP65 oil-resistant |

4 Operating Function

| Code | Description |
|------|------------------|
| M | Momentary |
| A | Alternate action |

2 Shape

| Code | Shape | Description |
|------|-------------|-----------------------|
| T | Round | Extended |
| A | Square | 2 directions, guarded |
| J | Rectangular | 2 directions, guarded |

5 Contact form and terminal type

| Code | Contact form | Terminal |
|------|--------------------|-----------------|
| 1 | 1C SPDT (See Note) | Solder terminal |
| 2 | 2C DPDT (See Note) | Solder terminal |

Note: SPDT: Single Pole, Double Throw
DPDT: Double Pole, Double Throw

3 Operator Color

| Code | Description |
|------|----------------------------------|
| R | Red |
| Y | Yellow |
| G | Green |
| W | White |
| A | Blue |
| B | Black (for non-illuminated only) |

(Actual color of yellow pushbuttons more closely resembles amber than true yellow.)

■ PART NUMBERS: NON-ILLUMINATED PUSHBUTTON SWITCHES (COMPLETE ASSEMBLY)

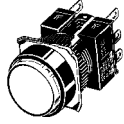
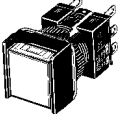
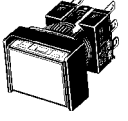
| Description | Shape | Contact | Part number | | | |
|---------------------------------|--|---------|-----------------|-----------------|--------------------------------|-----------------|
| | | | Momentary | | Alternate action (See Note 2.) | |
| | | | Enclosed (IP40) | Oiltight (IP65) | Enclosed (IP40) | Oiltight (IP65) |
| Non-Illuminated Standard Button | Round  | SPDT | A16-T□M-1 | A165-T□M-1 | A16-T□A-1 | A165-T□A-1 |
| | | DPDT | A16-T□M-2 | A165-T□M-2 | A16-T□A-2 | A165-T□A-2 |
| | Square  | SPDT | A16-A□M-1 | A165-A□M-1 | A16-A□A-1 | A165-A□A-1 |
| | | DPDT | A16-A□M-2 | A165-A□M-2 | A16-A□A-2 | A165-A□A-2 |
| | Rectangular  | SPDT | A16-J□M-1 | A165-J□M-1 | A16-J□A-1 | A165-J□A-1 |
| | | DPDT | A16-J□M-2 | A165-J□M-2 | A16-J□A-2 | A165-J□A-2 |

Note: 1. To complete the part number, in place of the □ symbol, specify the color code from the table below.
 2. Also described as Push-on / Push-off operation.

Operator Color Codes

(Actual color of yellow pushbuttons more closely resembles amber than true yellow.)

| Code | Color |
|------|--------|
| R | Red |
| Y | Yellow |
| G | Green |
| W | White |
| A | Blue |
| B | Black |

Note: Also described as Push-on/Push-off operation.

■ PART NUMBER LEGEND M16 ASSEMBLED PILOT LIGHTS

M16□-J



M16□-A



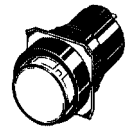

M16□-T

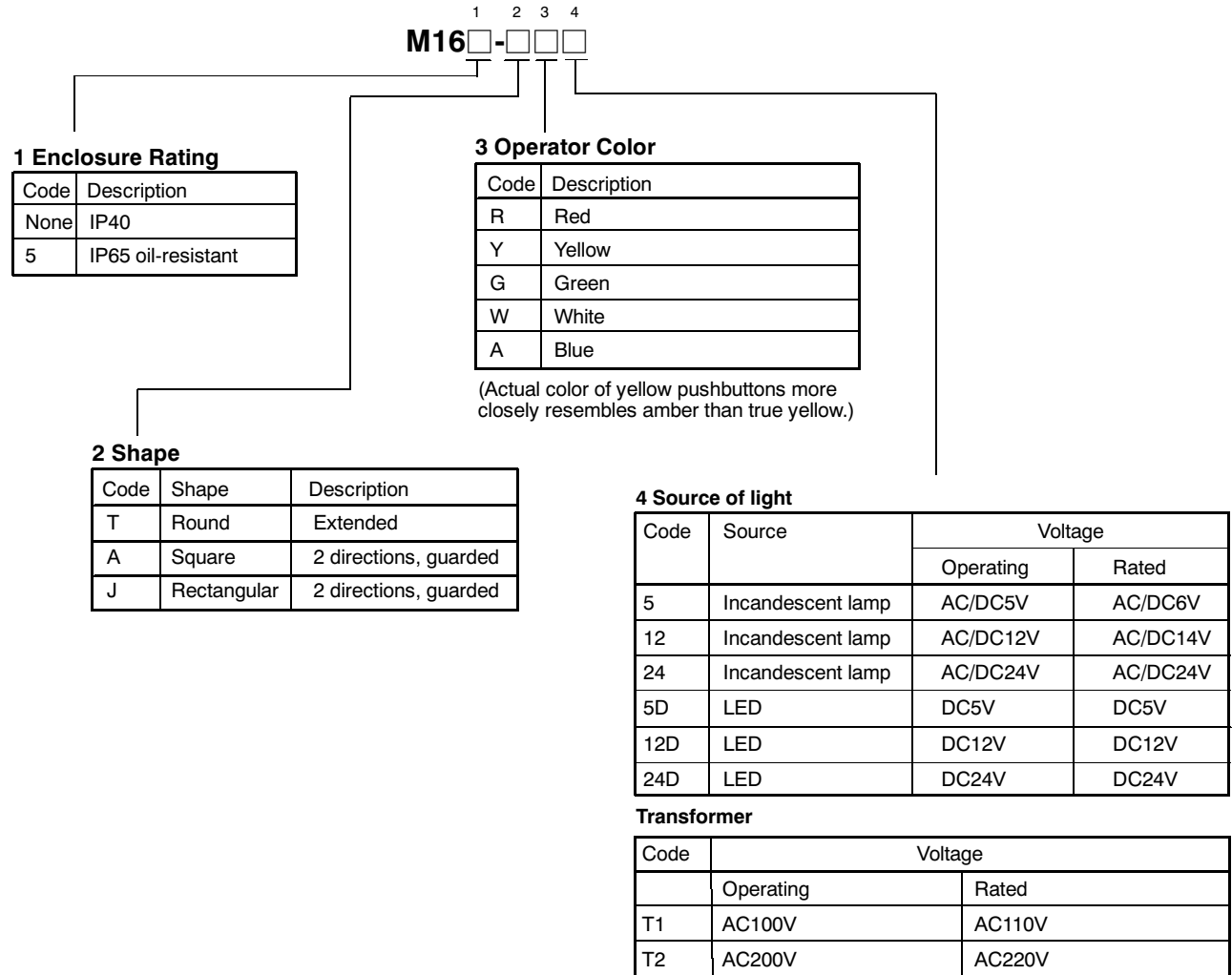

M16 Part number nomenclature



■ PART NUMBERS: PILOT LIGHTS (COMPLETE ASSEMBLY)

| Style | Type | Voltage | Part number | |
|--|---|-----------------------|-------------|---------------|
| | | | IP40 | IP65 Oiltight |
| Round  | Full voltage LED (DC) | 5 VDC | M16-T□-5D | M165-T□-5D |
| | | 12 VDC | M16-T□-12D | M165-T□-12D |
| | | 24 VDC | M16-T□-24D | M165-T□-24D |
| | Full voltage incandescent lamp (AC/DC) | 5 V AC/DC | M16-T□-5 | M165-T□-5 |
| | | 12 V AC/DC | M16-T□-12 | M165-T□-12 |
| | | 24 V AC/DC | M16-T□-24 | M165-T□-24 |
| | Transformer 24 V secondary | 110 VAC | M16-T□-T1 | M165-T□-T1 |
| | | 220 VAC | M16-T□-T2 | M165-T□-T2 |
| | Square  | Full voltage LED (DC) | 5 VDC | M16-A□-5D |
| 12 VDC | | | M16-A□-12D | M165-A□-12D |
| 24 VDC | | | M16-A□-24D | M165-A□-24D |
| Full voltage incandescent lamp (AC/DC) | | 5 V AC/DC | M16-A□-5 | M165-A□-5 |
| | | 12 V AC/DC | M16-A□-12 | M165-A□-12 |
| | | 24 V AC/DC | M16-A□-24 | M165-A□-24 |
| Transformer 24 V secondary | | 110 VAC | M16-A□-T1 | M165-A□-T1 |
| | | 220 VAC | M16-A□-T2 | M165-A□-T2 |
| Rectangular  | | Full voltage LED (DC) | 5 VDC | M16-J□-5D |
| | 12 VDC | | M16-J□-12D | M165-J□-12D |
| | 24 VDC | | M16-J□-24D | M165-J□-24D |
| | Full voltage incandescent lamp (AC/DC) | 5 V AC/DC | M16-J□-5 | M165-J□-5 |
| | | 12 V AC/DC | M16-J□-12 | M165-J□-12 |
| | | 24 V AC/DC | M16-J□-24 | M165-J□-24 |
| | Transformer 24 V secondary | 110 VAC | M16-J□-T1 | M165-J□-T1 |
| | | 220 VAC | M16-J□-T2 | M165-J□-T2 |

Note: To complete part number, in place of the □ symbol, specify the color code from the Lens Color Code table below.

Lens Color Codes

(Actual color of yellow lens more closely resembles amber than true yellow.)



| Code | Color |
|------|--------|
| R | Red |
| Y | Yellow |
| G | Green |
| W | White |
| A | Blue |

■ PART NUMBER LEGEND A16 ILLUMINATED PUSHBUTTONS (COMPLETE ASSEMBLY)

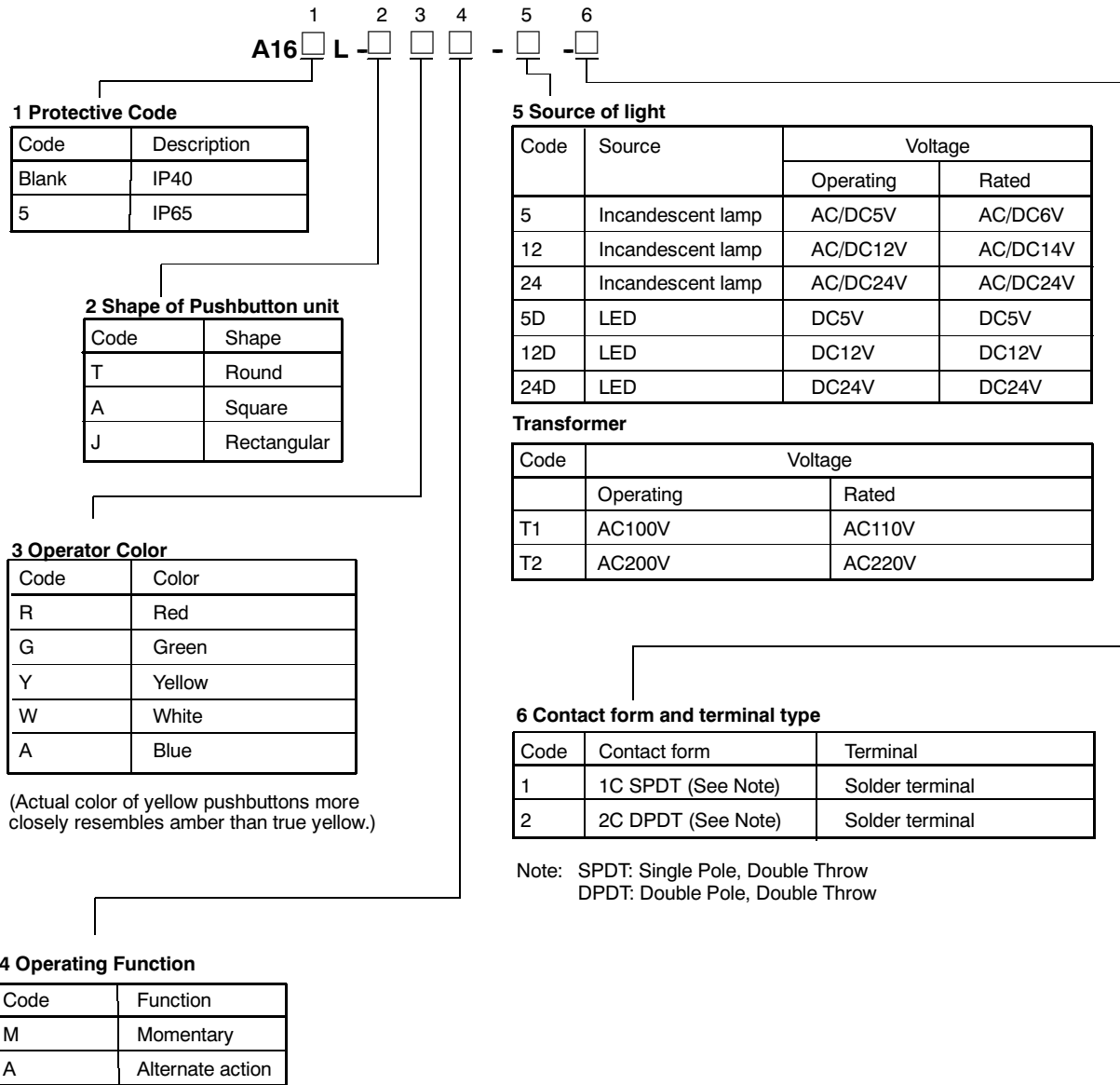
Part Number Nomenclature

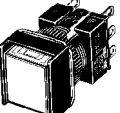

■ PART NUMBERS: A16 ILLUMINATED PUSHBUTTONS (COMPLETE ASSEMBLY)

| Style | Illumination method | Voltage | Contact | Part number | | | | |
|---|---------------------------|---------|---------------|-----------------|-----------------|------------------|-----------------|-----------------|
| | | | | Momentary | | Alternate action | | |
| | | | | Enclosed (IP40) | Oiltight (IP65) | Enclosed (IP40) | Oiltight (IP65) | |
|  | LED (DC) | 5V | SPDT | A16L-T□M-5D-1 | A165L-T□M-5D-1 | A16L-T□A-5D-1 | A165L-T□A-5D-1 | |
| | | 12V | | A16L-T□M-12D-1 | A165L-T□M-12D-1 | A16L-T□A-12D-1 | A165L-T□A-12D-1 | |
| | | 24V | | A16L-T□M-24D-1 | A165L-T□M-24D-1 | A16L-T□A-24D-1 | A165L-T□A-24D-1 | |
| | Incandescent lamp (AC/DC) | 5V | | A16L-T□M-5-1 | A165L-T□M-5-1 | A16L-T□A-5-1 | A165L-T□A-5-1 | |
| | | 12V | | A16L-T□M-12-1 | A165L-T□M-12-1 | A16L-T□A-12-1 | A165L-T□A-12-1 | |
| | | 24V | | A16L-T□M-24-1 | A165L-T□M-24-1 | A16L-T□A-24-1 | A165L-T□A-24-1 | |
| | LED (DC) | 5V | | DPDT | A16L-T□M-5D-2 | A165L-T□M-5D-2 | A16L-T□A-5D-2 | A165L-T□A-5D-2 |
| | | 12V | | | A16L-T□M-12D-2 | A165L-T□M-12D-2 | A16L-T□A-12D-2 | A165L-T□A-12D-2 |
| | | 24V | | | A16L-T□M-24D-2 | A165L-T□M-24D-2 | A16L-T□A-24D-2 | A165L-T□A-24D-2 |
| | Incandescent lamp (AC/DC) | 5V | A16L-T□M-5-2 | | A165L-T□M-5-2 | A16L-T□A-5-2 | A165L-T□A-5-2 | |
| | | 12V | A16L-T□M-12-2 | | A165L-T□M-12-2 | A16L-T□A-12-2 | A165L-T□A-12-2 | |
| | | 24V | A16L-T□M-24-2 | | A165L-T□M-24-2 | A16L-T□A-24-2 | A165L-T□A-24-2 | |
|  | LED (DC) | 5V | SPDT | | A16L-A□M-5D-1 | A165L-A□M-5D-1 | A16L-A□A-5D-1 | A165L-A□A-5D-1 |
| | | 12V | | | A16L-A□M-12D-1 | A165L-A□M-12D-1 | A16L-A□A-12D-1 | A165L-A□A-12D-1 |
| | | 24V | | | A16L-A□M-24D-1 | A165L-A□M-24D-1 | A16L-A□A-24D-1 | A165L-A□A-24D-1 |
| | Incandescent lamp (AC/DC) | 5V | | A16L-A□M-5-1 | A165L-A□M-5-1 | A16L-A□A-5-1 | A165L-A□A-5-1 | |
| | | 12V | | A16L-A□M-12-1 | A165L-A□M-12-1 | A16L-A□A-12-1 | A165L-A□A-12-1 | |
| | | 24V | | A16L-A□M-24-1 | A165L-A□M-24-1 | A16L-A□A-24-1 | A165L-A□A-24-1 | |
| | LED (DC) | 5V | | DPDT | A16L-A□M-5D-2 | A165L-A□M-5D-2 | A16L-A□A-5D-2 | A165L-A□A-5D-2 |
| | | 12V | | | A16L-A□M-12D-2 | A165L-A□M-12D-2 | A16L-A□A-12D-2 | A165L-A□A-12D-2 |
| | | 24V | | | A16L-A□M-24D-2 | A165L-A□M-24D-2 | A16L-A□A-24D-2 | A165L-A□A-24D-2 |
| | Incandescent lamp (AC/DC) | 5V | A16L-A□M-5-2 | | A165L-A□M-5-2 | A16L-A□A-5-2 | A165L-A□A-5-2 | |
| | | 12V | A16L-A□M-12-2 | | A165L-A□M-12-2 | A16L-A□A-12-2 | A165L-A□A-12-2 | |
| | | 24V | A16L-A□M-24-2 | | A165L-A□M-24-2 | A16L-A□A-24-2 | A165L-A□A-24-2 | |
|  | LED (DC) | 5V | SPDT | | A16L-J□M-5D-1 | A165L-J□M-5D-1 | A16L-J□A-5D-1 | A165L-J□A-5D-1 |
| | | 12V | | | A16L-J□M-12D-1 | A165L-J□M-12D-1 | A16L-J□A-12D-1 | A165L-J□A-12D-1 |
| | | 24V | | | A16L-J□M-24D-1 | A165L-J□M-24D-1 | A16L-J□A-24D-1 | A165L-J□A-24D-1 |
| | Incandescent lamp (AC/DC) | 5V | | A16L-J□M-5-1 | A165L-J□M-5-1 | A16L-J□A-5-1 | A165L-J□A-5-1 | |
| | | 12V | | A16L-J□M-12-1 | A165L-J□M-12-1 | A16L-J□A-12-1 | A165L-J□A-12-1 | |
| | | 24V | | A16L-J□M-24-1 | A165L-J□M-24-1 | A16L-J□A-24-1 | A165L-J□A-24-1 | |
| | LED (DC) | 5V | | DPDT | A16L-J□M-5D-2 | A165L-J□M-5D-2 | A16L-J□A-5D-2 | A165L-J□A-5D-2 |
| | | 12V | | | A16L-J□M-12D-2 | A165L-J□M-12D-2 | A16L-J□A-12D-2 | A165L-J□A-12D-2 |
| | | 24V | | | A16L-J□M-24D-2 | A165L-J□M-24D-2 | A16L-J□A-24D-2 | A165L-J□A-24D-2 |
| | Incandescent lamp (AC/DC) | 5V | A16L-J□M-5-2 | | A165L-J□M-5-2 | A16L-J□A-5-2 | A165L-J□A-5-2 | |
| | | 12V | A16L-J□M-12-2 | | A165L-J□M-12-2 | A16L-J□A-12-2 | A165L-J□A-12-2 | |
| | | 24V | A16L-J□M-24-2 | | A165L-J□M-24-2 | A16L-J□A-24-2 | A165L-J□A-24-2 | |

Note: To complete the part number, in place of the □ symbol, specify the color code from the Operator Color Code table below.



Operator Color Codes

(Actual color of yellow pushbuttons more closely resembles amber than true yellow.)





| Code | Color |
|------|--------|
| R | Red |
| Y | Yellow |
| G | Green |
| W | White |
| A | Blue |

Note: 1. To order illuminated pushbutton with 110 VAC transformer, replace the voltage code (5, 12, 24, 5D, 12D, 24D) with T1 for 110V or T2 for 220V. The secondary voltage of the transformer is always 24V.



■ ACCESSORIES (ORDER SEPARATELY)

| Name | Shape | Classification | Remarks | Part number |
|---------------|---|------------------|---|-------------|
| Switch guards |  | Rectangular | Cannot be used with the Dust Cover. | A16ZJ-5050 |
| | | Square and round | | A16ZA-5050 |
| Dust covers |  | Rectangular | Cannot be used with the Switch Cover. | A3BJ-5060 |
| | | Square | | A3BA-5060 |
| | | Round | | A3BT-5060 |
| Panel plugs |  | Rectangular | Used for covering the panel cutouts for future panel expansion. | A3BJ-3003 |
| | | Square | | A3BA-3003 |
| | | Round | | A3BT-3003 |

■ REPLACEMENTS

| Name | Shape | Classification | Remarks | Part number | |
|--|--|---|-----------------------------------|--------------|-------------|
| Legend panels |  | Rectangular | IP40 | Opaque | A16ZJ-5204 |
| | | | | Transparent | A16ZJ-5202 |
| | | | Oil-resistant IP65 | Opaque | A16ZJ-5204 |
| | | | | Transparent | A16ZJ-5203 |
| | | Square | IP40 | Opaque | A16ZA-5204 |
| | | | | Transparent | A16ZA-5202 |
| | | | Oil-resistant IP65 | Opaque | A16ZA-5204 |
| | | | | Transparent | A16ZA-5203 |
| | | Round | IP40 | Opaque | A16ZT-5204 |
| | | | | Transparent | A16ZT-5202 |
| | | | Oil-resistant IP65 | Opaque | A16ZT-5204 |
| | | | | Transparent | A16ZT-5203 |
| Color caps (for IP40) | Rectangular  | LED indicator/incandescent lamp/non-illuminated | White | A16Z□-5001W | |
| | | | Red | A16Z□-5001R | |
| | | | Yellow | A16Z□-5001Y | |
| | | LED indicator | Green | A16Z□-5001GY | |
| | | | Incandescent lamp/non-illuminated | Blue | A16Z□-5001A |
| | | | | Green | A16Z□-5001G |
| | Square  | LED indicator/incandescent lamp/non-illuminated | White | A16Z□-5011W | |
| | | | Red | A16Z□-5011R | |
| | | | Yellow | A16Z□-5011Y | |
| | | LED indicator | Green | A16Z□-5011GY | |
| | | | Incandescent lamp/non-illuminated | Blue | A16Z□-5011A |
| | | | | Green | A16Z□-5011G |
| Round  | LED indicator/incandescent lamp/non-illuminated | White | A16Z□-5101W | | |
| | | Red | A16Z□-5101R | | |
| | | Yellow | A16Z□-5101Y | | |
| | LED indicator | Green | A16Z□-5101GY | | |
| | | Incandescent lamp/non-illuminated | Blue | A16Z□-5101A | |
| | | | Green | A16Z□-5101G | |
| Color caps (for oil-resistant IP65) | Round  | LED indicator/incandescent lamp/non-illuminated | White | A16Z□-5111W | |
| | | | Red | A16Z□-5111R | |
| | | | Yellow | A16Z□-5111Y | |
| | | LED indicator | Green | A16Z□-5111GY | |
| | | | Incandescent lamp/non-illuminated | Blue | A16Z□-5111A |
| | | | | Green | A16Z□-5111G |

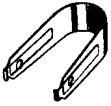
■ TOOLS

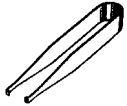
| Name | Shape | Applicable types | | | | | Remarks | Part number |
|-----------------------------|---|-------------------|---------------------------|--------------------------|---------------|-----------|---|------------------|
| | | Pushbutton Switch | Knob-type Selector Switch | Key-type Selector Switch | E-Stop Switch | Indicator | | |
| Pushbutton switch extractor |  | Yes | No | No | No | Yes | Convenient for extracting Pushbutton Switches | A3PJ-5080 |
| Screw fitting |  | Yes | Yes | Yes | Yes | Yes | Convenient for ganged installation. Tighten to a torque of 0.39 N • m (5 kg • cm) min. | A3B-3004 |
| Lamp unit extractor |  | Yes | Yes | Yes | Yes | Yes | Convenient for extracting the Switch Unit and Lamps. | A16Z-5080 |

Specifications

■ CHARACTERISTICS

| Item | | |
|---------------------------------|-------------|--|
| Allowable operating frequency | Mechanical | Momentary operation: 120 operations/min max. Alternating operation: 60 operations/min max. (See Note 1) |
| | Electrical | 20 operations/min max. |
| Insulation resistance | | 100 MΩ min. (at 500 VDC) |
| Dielectric strength | | 1,000 VAC, 50/60 Hz for 1 min between terminals of same polarity 2,000 VAC, 50/60 Hz for 1 min between terminals of different polarity and also between each terminal and ground 1,000 VAC, 50/60 Hz for 1 min between lamp terminals (See Note 2) |
| Vibration resistance | Malfunction | 10 to 55 Hz, 1.5-mm double amplitude (malfunction within 1 ms) |
| Shock resistance | Mechanical | 500 m/s ² (50G) |
| | Malfunction | 150 m/s ² (15G) max. (malfunction within 1 ms) |
| Life expectancy | Mechanical | Momentary operation: 2,000,000 operations min. Alternating operation: 200,000 operations min. |
| | Electrical | 100,000 operations min. |
| Ambient temperature | | Operating: -10°C to 55°C (14°F to 131°F) with no icing or condensation Storage: -25°C to 65°C (-13°F to 149°F) with no icing or condensation |
| Ambient humidity | | Operating: 35% to 85% |
| Electric shock protection class | | Class II |
| Degree of contamination | | 3 (IEC947-5-1) |
| Weight | | Approx. 10 g (0.35 oz) in the case of a Illuminated DPDT switch with solder terminals |

- Note: 1. Set and reset constitute one operation.
2. With LED and incandescent lamp not mounted.

■ APPROVED STANDARDS

| Recognized organization | Standards | File No. |
|-------------------------|-------------|----------|
| UL, cUL (See Note) | UL508 | E41515 |
| ASTA | EN60947-5-1 | — |

Note: UL: CSA C22 No. 14

■ RATINGS

| | |
|------------------------------|--------------------------|
| AC resistive load (AC15) | DC resistive load (DC13) |
| 3 A, 250 VAC 5 A, 125 VAC | 3 A, 30 VDC |

Minimum applicable load: 1 mA at 5 VDC

Rated values are obtained from tests conducted under the following conditions according to JIS C4505 and C4520.

1. Load: Resistive load
2. Mounting conditions: No vibration and no shock
3. Temperature: 20°±2°C
4. Operating frequency: 20 operations/min

Contact

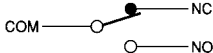
| | |
|------|--|
| Name | Contact |
| SPDT |  |

LED

| Rated voltage | Rated current | Operating voltage | Internal limiting resistor |
|---------------|---------------|-------------------|----------------------------|
| 5 VDC | 30 mA | 5 VDC±5% | 33 Ω |
| 12 VDC | 15 mA | 12 VDC±5% | 270 Ω |
| 24 VDC | 10 mA | 24 VDC±5% | 1600 Ω |

Incandescent Lamp

| Rated voltage | Rated current | Operating voltage |
|---------------|---------------|-------------------|
| 6 VAC/DC | 60 mA | 5 VAC/DC |
| 14 VAC/DC | 40 mA | 12 VAC/DC |
| 28 VAC/DC | 24 mA | 24 VAC/DC |

■ OPERATING CHARACTERISTICS

| Type | Pushbutton Switch | | | |
|-----------------------------------|-------------------|-----------------|--------------------|-----------------|
| | IP40 | | Oil-resistant IP65 | |
| | SPDT | DPDT | SPDT | DPDT |
| Operating force (OF) max. | 2.45 N (250 gf) | 4.41 N (450 gf) | 2.94 N (300 gf) | 4.91 N (500 gf) |
| Releasing force (RF) min. | 0.29 N (30 gf) | | | |
| Total travel (TT) | Approx. 3 mm | | | |
| Pretravel (PT) max. | 2.5 mm | | | |
| Lock stroke (LTA) min. (See Note) | 0.5 mm | | | |

Note: Lock stroke is only for alternating operation.

Dimensions

Unit: mm (inch)

■ ILLUMINATED/NON-ILLUMINATED PUSHBUTTON SWITCHES WITHOUT TRANSFORMER

The lamp terminal is also provided with non-illuminated models.

Solder terminals and tab terminals (#110) can be both used with Illuminated and Non-Illuminated Pushbutton Switches.

Rectangular A16□-J

Solder terminals (tab terminals #110)

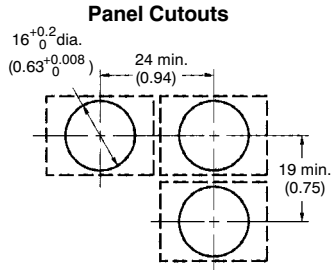
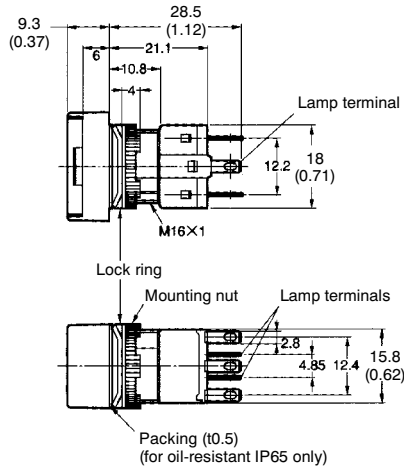
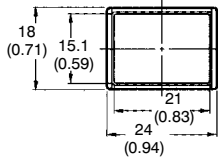
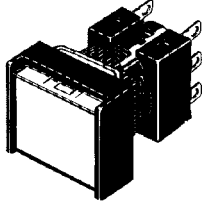

Square A16□-A

Solder terminals (tab terminals #110)

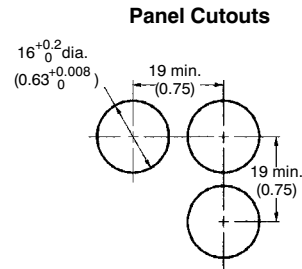
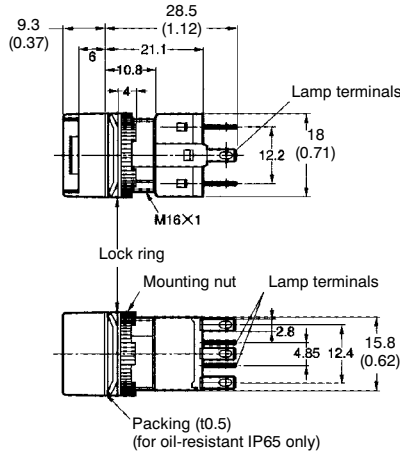
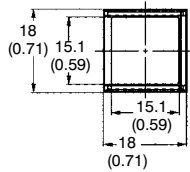
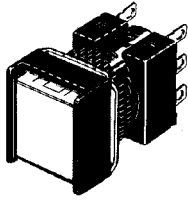

Round A16□-T

Solder terminals (tab terminals #110)

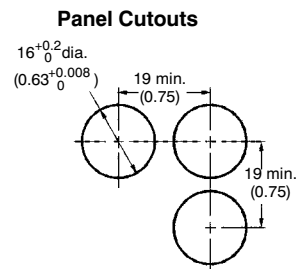
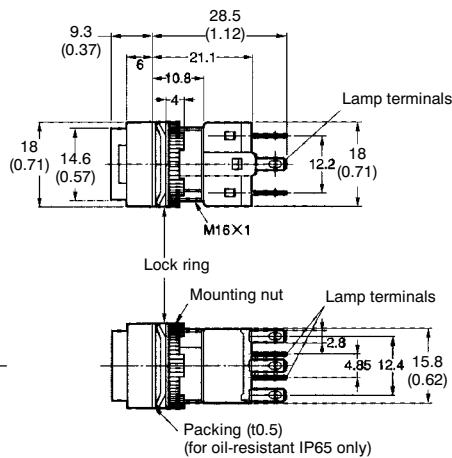
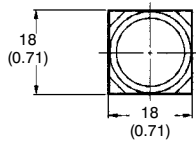
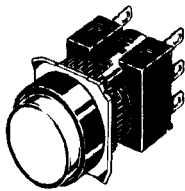

Note: 1. Make sure the thickness of the mounting panel is between 0.5 and 3.2 mm. If, however, a Switch Guard or Dust Cover is used, the thickness of the mounting panel must be between 0.5 and 2 mm.

2. If a panel is to be finished with coating, etc., make sure that the panel meets the specified dimensions after coating.

■ INDICATORS WITHOUT TRANSFORMER

**Rectangular
M16-J**

Solder terminals (tab terminals #110)

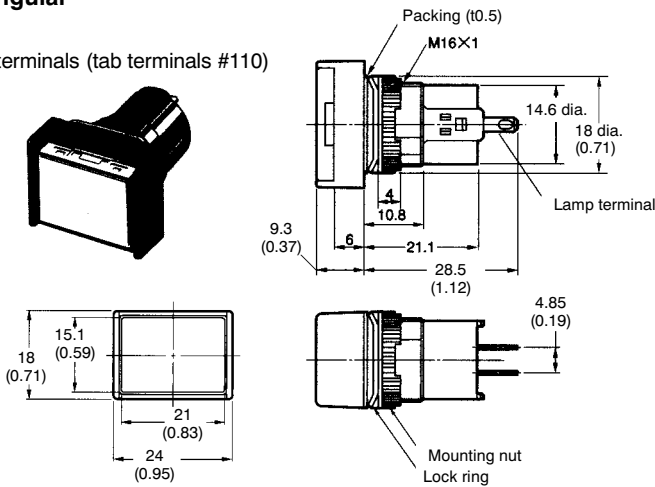

**Panel cutouts
(Top View)**

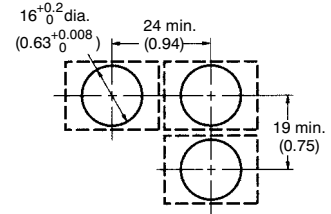

**Square
M16-A**

Solder terminals (tab terminals #110)

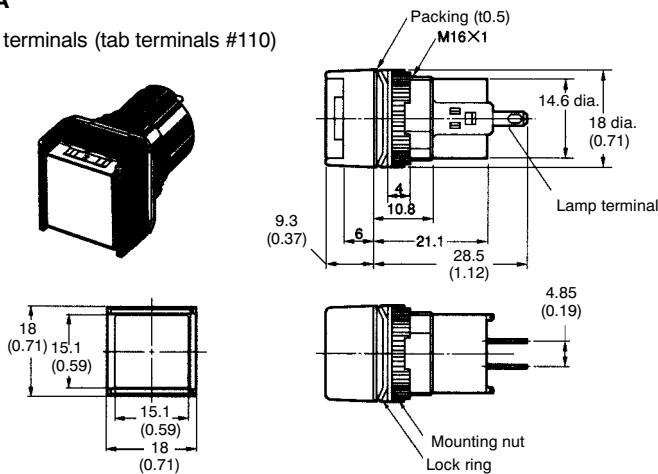

**Panel cutouts
(Top View)**

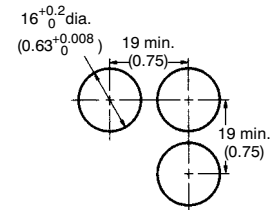

**Round
M16-T**

Solder terminals (tab terminals #110)

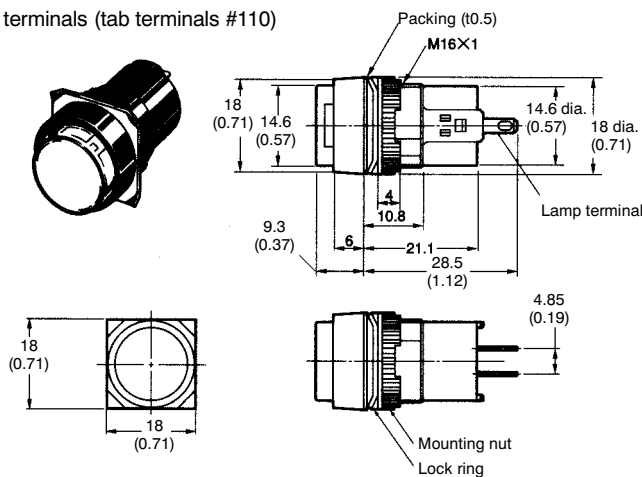

**Panel cutouts
(Top View)**

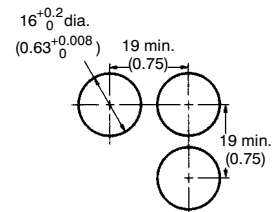

- Note: 1. Make sure the thickness of the mounting panel is between 0.5 and 3.2 mm. If, however, a Switch Guard or Dust Cover is used, the thickness of the mounting panel must be between 0.5 and 2 mm.
2. If a panel is to be finished with coating, etc., make sure that the panel meets the specified dimensions after coating.

Unit: mm (inch)

LAMPS

LED

A16-5D□/-12D□/-24D□

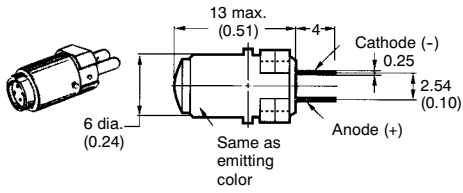

Incandescent Lamp

A16-5/-12/-24

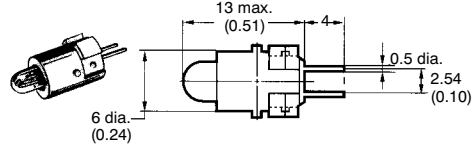

TERMINAL ARRANGEMENT

Non-Illuminated Pushbutton Switches are also provided with lamp terminals.

SPDT Switches

Illuminated type

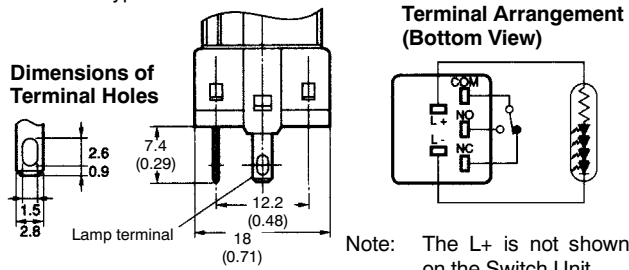

DPDT Switches

Illuminated type

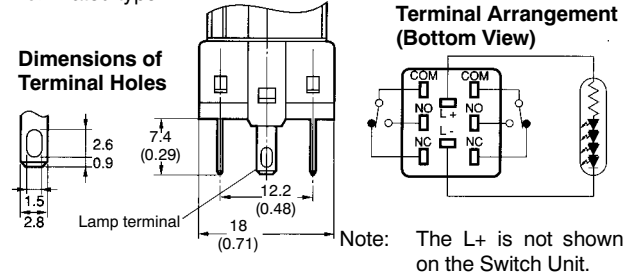

Pilot lights

Dimensions of Terminal Holes

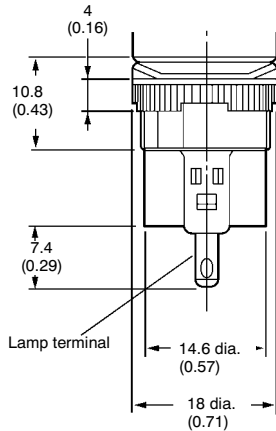
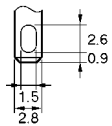

Terminal Arrangement (Bottom View)

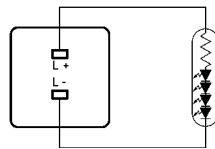

Note: The L+ is not shown on the Switch Unit.

■ ACCESSORIES, TOOLS, AND COMPONENTS

**Pushbutton switch extractor
A3PJ-5080**

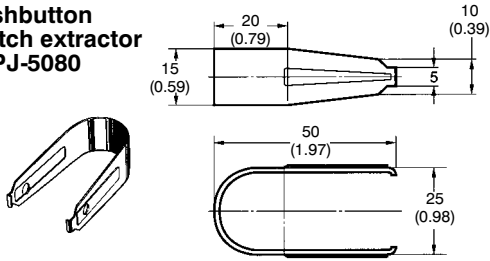

**Legend Panels
A16ZJ-520□**

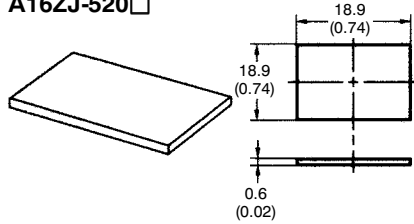

A16ZA-520□

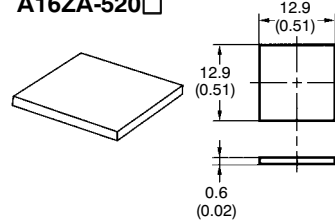

A16ZT-520□

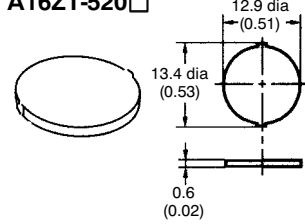

- Note: 1. The panel is 0.6 mm thick.
2. The panel is made of the materials listed in the following table.

| Color | Degree of protection | Materials |
|-------------|----------------------|---------------------|
| Opaque | IP40 | Polyacrylate resin |
| | IP65 | |
| Transparent | IP40 | Polycarbonate resin |
| | IP65 | Polyacrylate resin |

Note: The standard model is transparent.

**Screw Fitting
A3B-3004**

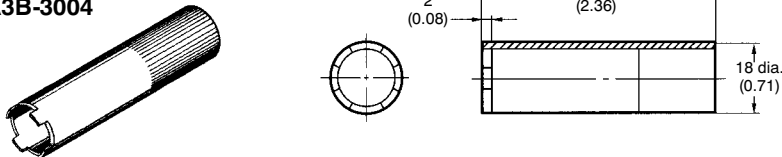

Panel Plugs (Black Resin)

Select the Plug that fits the panel design and mount from the front of the Panel. Panel cutouts are the same as those for Switches.

**Rectangular
A3BJ-3003**

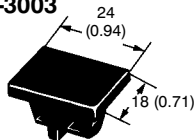

**Square
A3BA-3003**

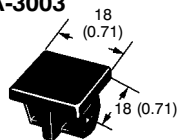

**Round
A3BT-3003**

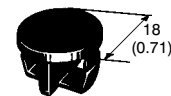

Lock Fitting

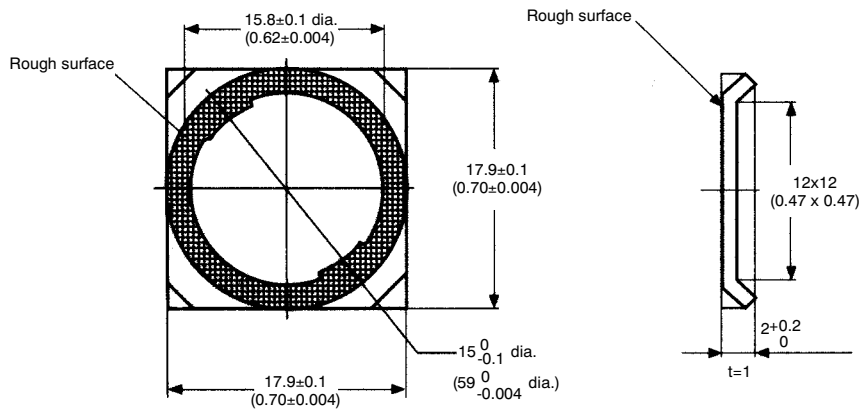

Lamp unit extractor
A16Z-5080

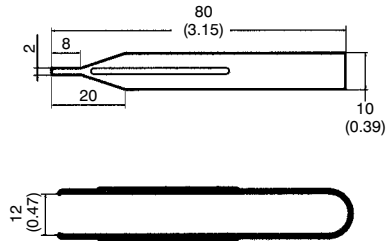
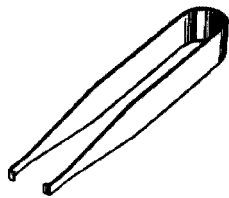

Dimensions When Mounting Accessories

Unit: mm (inch)

■ SWITCH GUARDS

Rectangular A16ZJ-5050

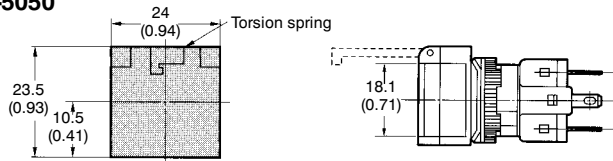

Panel Cutouts (Top View)

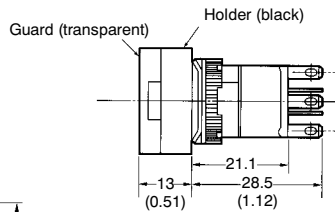
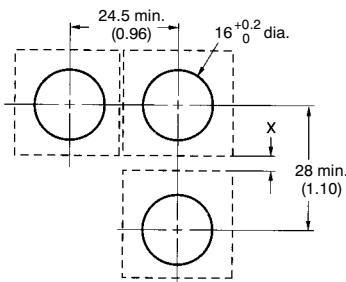

Note: The above illustration shows a case where 4.5 mm is provided for the distance "x." If no clearance is required for the "x" section, the vertical mounting dimension can be as small as 24 mm. Set this distance according to operating conditions.

Square A16ZA-5050

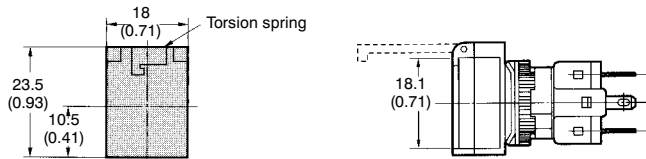

Panel Cutouts (Top View)

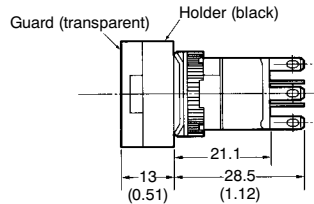
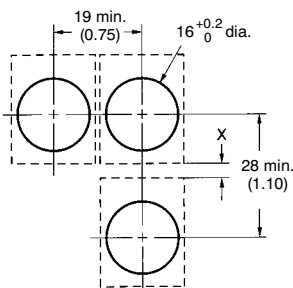

Note: The above illustration shows a case where 4.5 mm is provided for the distance "x." If no clearance is required for the "x" section, the vertical mounting dimension can be as small as 24 mm. Set this distance according to operating conditions.

■ DUST COVERS

**Rectangular
A3BJ-5060**

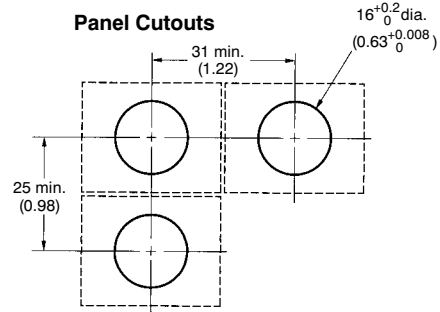
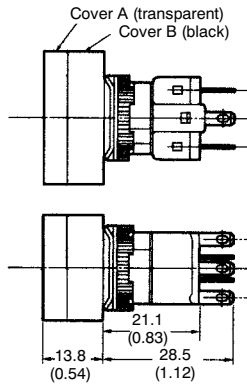
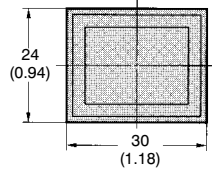

**Square
A3BA-5060**

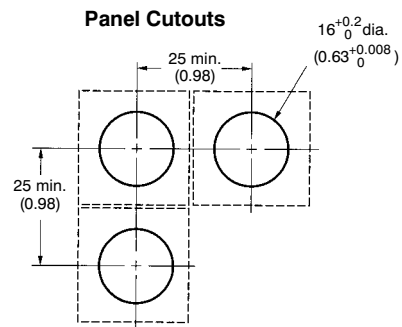
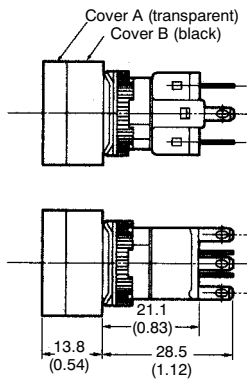
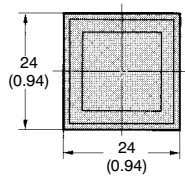

**Round
A16ZT-5050**

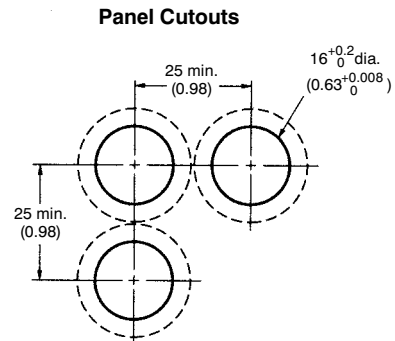
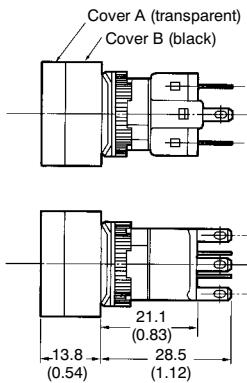
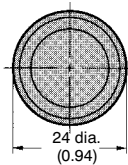

Installation

■ MOUNTING

After mounting the Pushbutton Unit to the panel, snap in the Socket Unit from the back of the panel.

Panel mounting

Insert the Pushbutton Unit into the front of the panel, and fix the lock ring and mounting nut from the terminal side.

Make sure that the lock ring is aligned with the thread of the case and the edge of the lock ring is touching the panel.

Tighten the mounting nuts to a torque of 0.20 to 0.39 N • m (3 to 5 kgf • cm).

The maximum tightening torque is 0.39 N • m (5 kgf • cm).

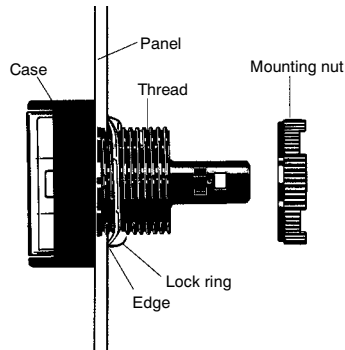

Switch Mounting

Snap on the Switch Unit to the Pushbutton Unit.

Make sure the the Switch Unit is in the proper orientation when snapping on to the Pushbutton Unit.

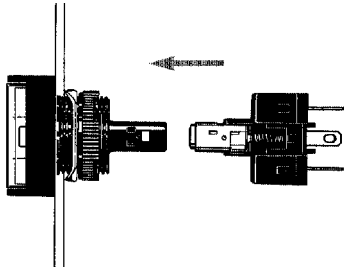

■ SWITCH REMOVAL

Grip the part between the Switch holder of the case and the Switch Unit using the A16Z-5080 Extractor, and pull to remove the Switch Unit.

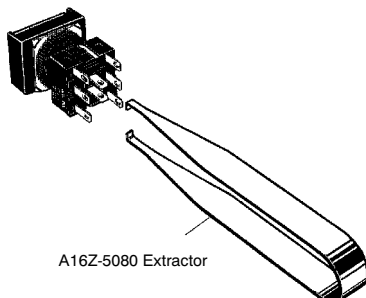

■ REPLACEMENT PARTS

Removal and installation of the Operating Part

1. Remove the operating part as shown in the following diagram. If the operating part cannot be removed by hand, use the A3PJ-5080 Extractor.

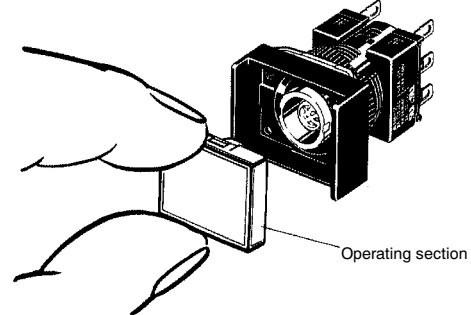

2. To attach the operating part, push until it clicks into place.

■ REMOVING THE LAMP

Removing from the Operating Part End

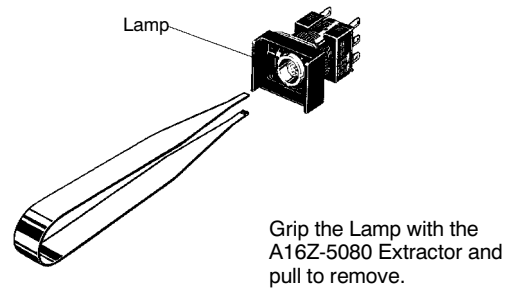

Removing from the Switch Unit End

The Lamp can be removed by hand once the Switch is removed using the A16Z-5080 Extractor.

■ INSTALLING THE LAMP

When mounting the Lamp, make sure it is facing the direction shown in the following diagram. Insert the Lamp while matching the protruding part of the Lamp and the small guides on the outer surface of the case.

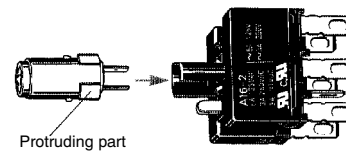

The Lamp can be mounted from the operating part end by using the A16Z-5080 Extractor. The lamp can be mounted by following the opposite procedure for removing the Lamp.

Precautions

⚠ WARNING

Do not apply a voltage between the incandescent lamp and the terminal that is greater than the rated voltage. If the incandescent lamp is broken, the operating part may pop out.

Always turn OFF the power and wait for 10 minutes before replacing the incandescent lamp. If the lamp is replaced immediately after the power is turned OFF, the remaining heat may cause burns.

■ CORRECT USE

Mounting

Always make sure that the power is turned OFF before mounting, removing, or wiring the Switch, or performing maintenance.

Do not tighten the mounting nut more than necessary using tools such as pointed-nose pliers. Doing so will damage the mounting nut. The tightening torque is 0.20 to 0.39 N • m (3 to 5 kgf • cm).

Wiring

Solder terminals and quick-connect terminals (#110) are commonly used for terminals.

Be sure to use electrical wires that are a size appropriate for the applied voltage and carry current (conductor size is 0.5 to 0.75 mm²). Perform soldering according to the conditions provided below. If the soldering is not properly performed, the lead wires will become detached, resulting in short-circuits.

1. Hand soldering: 30 W, within 5 s
2. Dip soldering: 240°C, within 3 s

Wait for one minute after soldering before exerting any external force on the solder.

Use non-corrosive resin fluid as the flux.

Make sure that the electric cord is wired so that it does not touch the Unit. If the electric cord will touch the Unit, then electric wires with a heat resistance of 100°C min. must be used.

After wiring the Switch, maintain an appropriate clearance and creepage distance.

Operating Environment

The IP65 model is designed with a protective structure so that it will not sustain damage if it is subjected to water from any direction to the front of the panel.

Using the Microload

Insert a contact protection circuit, if necessary, to prevent the reduction of life expectancy due to extreme wear on the contacts caused by loads where inrush current occurs when the contact is opened and closed.

The A16 allows both a general-purpose load (125 V at 5A, 250 V at 3 A) and a microload. If a general-purpose load is applied, however, the microload area cannot be used. If the microload area is used with a general-purpose load, the contact surface will become rough, and the opening and closing of the contact for a microload may become unreliable.

The minimum applicable load is the N-level reference value. This value indicates the malfunction reference level for the reliability level of 60% (λ 60) (conforming to JIS C5003).

The equation, λ 60 = 0.5×10^{-4} /time indicates that the estimated malfunction rate is less than 1/2,000,000 with a reliability level of 60%.

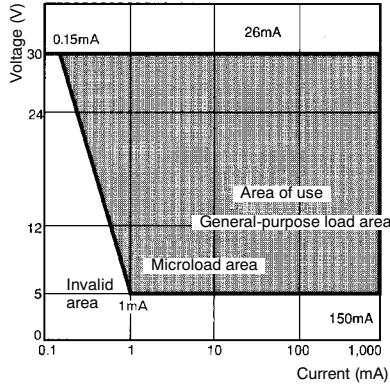

LEDs

The LED current-limiting resistor is built-in, so internal resistance is not required.

| Rated voltage | Internal limiting resistor |
|---------------|----------------------------|
| 5 VDC | 33 Ω |
| 12 VDC | 270 Ω |
| 24 VDC | 1600 Ω |

Others

The oil-resistant IP65 uses NBR rubber and is resistant to general cutting oil and cooling oil. Some particular oils cannot be used with the oil-resistant IP65, however, so contact your OMRON representative for details.

If the panel is to be finished with coating, etc., make sure that the panel meets the specified dimensions after the coating.

Do not subject the Switch to extreme shock or vibration. Doing so will cause malfunctions and damage to the Switch.

Do not let sharp objects come into contact with the Switches that are made of resin. Doing so will damage the Switches, causing scratches on the outside of the operating parts, and malfunction.

When handling the Switches, do not throw or drop them.

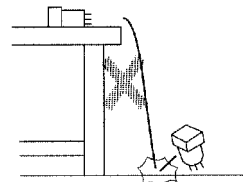

Do not allow the Switch to drop and hit the ground.

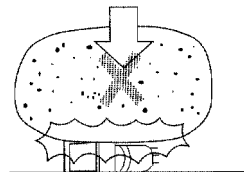

Do not place or drop heavy objects on the Switch.

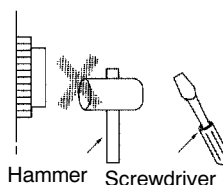

Do not operate the Switch with hard or sharp objects.

Knob-Type Selector Switch

A165S/W

Mounting Aperture of 16 mm

- 2-piece construction requires no tools
- Oil-resistant IP65 models
- Short mounting depth, less than 28.5 mm below panel
- Wide range of switching capacity from general to microload
- Illuminated and non-illuminated models
- 2 and 3-position models
- Maintained and spring return reset
- UL and CSA approved, VDE pending
- Conforms to EN60947-5-1, IEC947-5-1



Ordering Information

■ CONSTRUCTION

Flange Shape

Protective Case and Terminal Type

- **Protective Structure**
Oil-resistant IP65
- **Terminal Type**
Solder terminals
(tab terminals #110)

Lamp

- LED

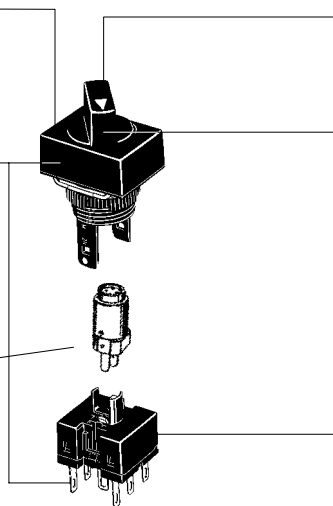

Available Colors

- For LED
Red, green, yellow

Number of Positions and Reset Method

- **2 Positions**
Maintained
Spring return
- **3 Positions**
Maintained
Spring return

Switch Unit Specifications

- **General-purpose Loads**
125 VAC: 5 A
250 VAC: 3 A
30 VDC 3 A
Minimum applicable load: 1 mA at 5 VDC

■ PART NUMBER LEGEND A165 SELECTOR SWITCH (COMPLETE ASSEMBLY)

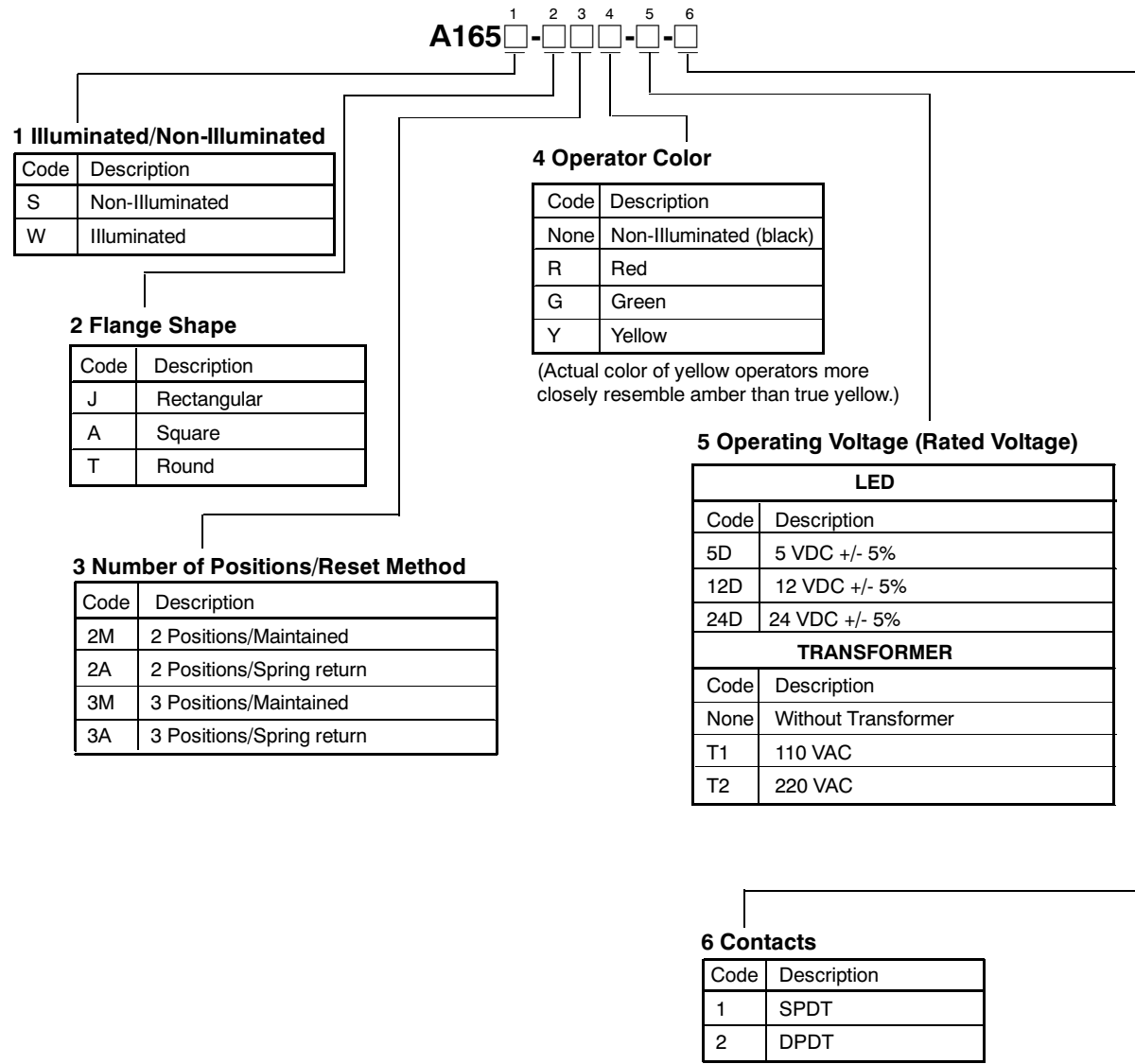

■ PART NUMBERS: A165S ASSEMBLED NON-ILLUMINATED KNOB-TYPE SELECTOR SWITCH
(COMPLETE ASSEMBLY)

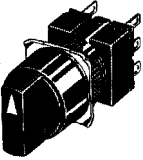
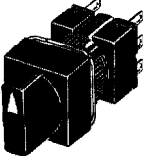
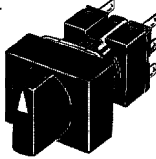
| Shape | Number of positions | Contact | Reset method | Part number |
|--|---------------------|---------|-----------------------|-------------|
| Round  | 2 positions | SPDT | Maintained | A165S-T2M-1 |
| | | | Spring return (right) | A165S-T2A-1 |
| | 3 positions | DPDT | Maintained | A165S-T2M-2 |
| | | | Spring return (right) | A165S-T2A-2 |
| | | | Maintained | A165S-T3M-2 |
| | | | Spring return (both) | A165S-T3A-2 |
| Square  | 2 positions | SPDT | Maintained | A165S-A2M-1 |
| | | | Spring return (right) | A165S-A2A-1 |
| | 3 positions | DPDT | Maintained | A165S-A2M-2 |
| | | | Spring return (right) | A165S-A2A-2 |
| | | | Maintained | A165S-A3M-2 |
| | | | Spring return (both) | A165S-A3A-2 |
| Rectangular  | 2 positions | SPDT | Maintained | A165S-J2M-1 |
| | | | Spring return (right) | A165S-J2A-1 |
| | 3 positions | DPDT | Maintained | A165S-J2M-2 |
| | | | Spring return (right) | A165S-J2A-2 |
| | | | Maintained | A165S-J3M-2 |
| | | | Spring return (both) | A165S-J3A-2 |

■ A165W ILLUMINATED (2 POSITION) KNOB-TYPE SELECTOR SWITCH (COMPLETE ASSEMBLY)

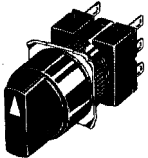
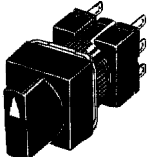
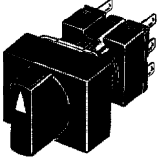
| Description | | | | Part number | | |
|--|---|---|-----------------------|------------------|--------------------------|-----------------|
| Appearance | Type | Rated voltage | Contacts | Maintained | Spring return from right | |
| Round  | Full voltage LED (DC) | 5 VDC | SPDT | A165W-T2M□-5D-1 | A165W-T2A□-5D-1 | |
| | | 12 VDC | | A165W-T2M□-12D-1 | A165W-T2A□-12D-1 | |
| | | 24 VDC | | A165W-T2M□-24D-1 | A165W-T2A□-24D-1 | |
| | Transformer 24 V Secondary | 110 VAC | | A165W-T2M□-T1-1 | A165W-T2A□-T1-1 | |
| | | 220 VAC | | A165W-T2M□-T2-1 | A165W-T2A□-T2-1 | |
| | | Full voltage LED (DC) | | 5 VDC | DPDT | A165W-T2M□-5D-2 |
| | 12 VDC | | A165W-T2M□-12D-2 | A165W-T2A□-12D-2 | | |
| | 24 VDC | | A165W-T2M□-24D-2 | A165W-T2A□-24D-2 | | |
| | Transformer 24 V Secondary | 110 VAC | A165W-T2M□-T1-2 | A165W-T2A□-T1-2 | | |
| | | 220 VAC | A165W-T2M□-T2-2 | A165W-T2A□-T2-2 | | |
| | | Square  | Full voltage LED (DC) | 5 VDC | | SPDT |
| | 12 VDC | | | A165W-A2M□-12D-1 | A165W-A2A□-12D-1 | |
| 24 VDC | A165W-A2M□-24D-1 | | | A165W-A2A□-24D-1 | | |
| Transformer 24 V Secondary | 110 VAC | | A165W-A2M□-T1-1 | A165W-A2A□-T1-1 | | |
| | 220 VAC | | A165W-A2M□-T2-1 | A165W-A2A□-T2-1 | | |
| | Full voltage LED (DC) | | 5 VDC | DPDT | A165W-A2M□-5D-2 | |
| 12 VDC | | | A165W-A2M□-12D-2 | | A165W-A2A□-12D-2 | |
| 24 VDC | | | A165W-A2M□-24D-2 | | A165W-A2A□-24D-2 | |
| Transformer 24 V Secondary | 110 VAC | | A165W-A2M□-T1-2 | | A165W-A2A□-T1-2 | |
| | 220 VAC | | A165W-A2M□-T2-2 | | A165W-A2A□-T2-2 | |
| | Rectangular  | | Full voltage LED (DC) | | 5 VDC | SPDT |
| 12 VDC | | | | A165W-J2M□-12D-1 | A165W-J2A□-12D-1 | |
| 24 VDC | | A165W-J2M□-24D-1 | | A165W-J2A□-24D-1 | | |
| Transformer 24 V Secondary | | 110 VAC | A165W-J2M□-T1-1 | A165W-J2A□-T1-1 | | |
| | | 220 VAC | A165W-J2M□-T2-1 | A165W-J2A□-T2-1 | | |
| | | Full voltage LED (DC) | 5 VDC | DPDT | A165W-J2M□-5D-2 | |
| 12 VDC | | | A165W-J2M□-12D-2 | | A165W-J2A□-12D-2 | |
| 24 VDC | | | A165W-J2M□-24D-2 | | A165W-J2A□-24D-2 | |
| Transformer 24 V Secondary | | 110 VAC | A165W-J2M□-T1-2 | | A165W-J2A□-T1-2 | |
| | | 220 VAC | A165W-J2M□-T2-2 | | A165W-J2A□-T2-2 | |

Note: To complete the part number, replace the □ symbol with the appropriate color code from the *Operator Color Code* table below.

Operator Color Codes

(Actual color of yellow pushbuttons more closely resembles amber than true yellow).

| Code | Color |
|------|--------|
| R | Red |
| Y | Yellow |
| G | Green |

■ A165W ILLUMINATED (3 POSITION) KNOB-TYPE SELECTOR SWITCH (COMPLETE ASSEMBLY)

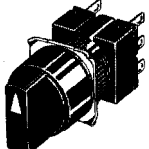
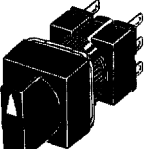
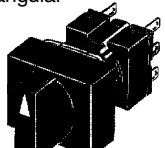
| Description | | | | Part number | |
|--|----------------------------|---------------|----------|------------------|-------------------------|
| Appearance | Type | Rated voltage | Contacts | Maintained | Spring return from both |
| Round  | Full voltage LED (DC) | 5 VDC | DPDT | A165W-T3M□-5D-2 | A165W-T3A□-5D-2 |
| | | 12 VDC | | A165W-T3M□-12D-2 | A165W-T3A□-12D-2 |
| | | 24 VDC | | A165W-T3M□-24D-2 | A165W-T3A□-24D-2 |
| | Transformer 24 V Secondary | 110 VAC | | A165W-T3M□-T1-2 | A165W-T3A□-T1-2 |
| | | 220 VAC | | A165W-T3M□-T2-2 | A165W-T3A□-T2-2 |
| | | | | | |
| Square  | Full voltage LED (DC) | 5 VDC | DPDT | A165W-A3M□-5D-2 | A165W-A3A□-5D-2 |
| | | 12 VDC | | A165W-A3M□-12D-2 | A165W-A3A□-12D-2 |
| | | 24 VDC | | A165W-A3M□-24D-2 | A165W-A3A□-24D-2 |
| | Transformer 24 V Secondary | 110 VAC | | A165W-A3M□-T1-2 | A165W-A3A□-T1-2 |
| | | 220 VAC | | A165W-A3M□-T2-2 | A165W-A3A□-T2-2 |
| | | | | | |
| Rectangular  | Full voltage LED (DC) | 5 VDC | DPDT | A165W-J3M□-5D-2 | A165W-J3A□-5D-2 |
| | | 12 VDC | | A165W-J3M□-12D-2 | A165W-J3A□-12D-2 |
| | | 24 VDC | | A165W-J3M□-24D-2 | A165W-J3A□-24D-2 |
| | Transformer 24 V Secondary | 110 VAC | | A165W-J3M□-T1-2 | A165W-J3A□-T1-2 |
| | | 220 VAC | | A165W-J3M□-T2-2 | A165W-J3A□-T2-2 |
| | | | | | |

Note: To complete the part number, replace the □ symbol with the appropriate color code from the Operator *Color Code* table below.

Operator Color Codes

(Actual color of yellow pushbuttons more closely resembles amber than true yellow).

| Code | Color |
|------|--------|
| R | Red |
| Y | Yellow |
| G | Green |

Accessories (Order Separately)

■ PANEL PLUGS

| Shape | Classification | Remarks | Part number |
|---|----------------|---|-------------|
|  | Rectangular | Used for covering the panel cutouts for future panel expansion. | A3BJ-3003 |
| | Square | | A3BA-3003 |
| | Round | | A3BT-3003 |

■ TOOLS

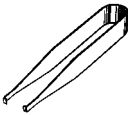
| Name | Shape | Applicable types | | | | | Remarks | Part number |
|---------------|---|-------------------|---------------------------|--------------------------|-----------------------|-------------|--|-------------|
| | | Pushbutton Switch | Knob-type Selector Switch | Key-type Selector Switch | Emergency Stop Switch | Pilot Light | | |
| Screw fitting |  | Yes | Yes | Yes | Yes | Yes | Convenient for ganged installation. Tighten to a torque of 0.39 N • m (5 kgf • cm) min. | A3B-3004 |
| Extractor |  | Yes | Yes | Yes | Yes | Yes | Convenient for extracting the Switch Unit and Lamps. | A16Z-5080 |

Specifications

■ APPROVED STANDARDS

UL, cUL (File No. E41515)

5 A at 125 VAC, 3 A at 250 VAC (general use)
3 A at 30 VDC (resistive)

EN60947-5-1 (Low Voltage Directive)

■ RATINGS

| AC resistive load (AC15) | DC resistive load (DC13) |
|------------------------------|--------------------------|
| 3 A, 250 VAC 5 A, 125 VAC | 3 A, 30 VDC |

Minimum applicable load: 1 mA at 5 VDC

Rated values are obtained from tests conducted under the following conditions according to JIS C4505 and C4520.

1. Load: Resistive load
2. Mounting conditions: No vibration and no shock
3. Temperature: 20°±2°C (68F°±3.6F°)
4. Operating frequency: 20 times/min

■ CONTACT

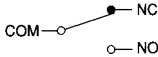
| Name | Contact |
|------|--|
| SPDT |  |

■ LED

| Rated voltage | Rated current | Operating voltage | Internal limiting resistor |
|---------------|---------------|-------------------|----------------------------|
| 5 VDC | 30 mA | 5 VDC±5% | 33 Ω |
| 12 VDC | 15 mA | 12 VDC±5% | 270 Ω |
| 24 VDC | 10 mA | 24 VDC±5% | 1600 Ω |

■ CHARACTERISTICS

| | | |
|--|--|--|
| Item | Knob-type Selector Switch | |
| Allowable operating frequency (See Note 1.) | Mechanical | 20 operations/min max. |
| | Electrical | 10 operations/min max. |
| Insulation resistance | 100 M Ω min. (at 500 VDC) | |
| Dielectric strength | 1,000 VAC, 50/60 Hz for 1 min between terminals of same polarity 2,000 VAC, 50/60 Hz for 1 min between terminals of different polarity and also between each terminal and ground 1,000 VAC, 50/60 Hz for 1 min between lamp terminals (See note 2) | |
| Vibration resistance | Malfunction | 10 to 55 Hz, 1.5-mm double amplitude (malfunction within 1 ms) |
| Shock resistance | Mechanical | 500 m/s ² (50G) |
| | Malfunction | 150 m/s ² (15G) max. (malfunction within 1 ms) |
| Life expectancy | Mechanical | 250,000 operations min. |
| | Electrical | 100,000 operations min. |
| Ambient temperature | Operating: -10°C to 55°C (14°F to 131°F) with no icing or condensation Storage: -25°C to 65°C (-13°F to 149°F) with no icing or condensation | |
| Ambient humidity | Operating: 35% to 85% | |
| Electric shock protection class | Class II | |
| Degree of contamination | 3 (IEC947-5-1) | |
| Weight | Approx. 13 g (0.46 oz) in the case of a Illuminated DPDT switch | |

- Note: 1. Set and reset constitute one operation.
2. With LED and incandescent lamp not mounted.

■ OPERATING CHARACTERISTICS

| | | |
|---------------------------|---------------------------|--------------|
| Features | Knob-type Selector Switch | |
| | 2 Positions | 3 Positions |
| Operating force (OF) max. | 0.1 N • m (1,000 gf • cm) | |
| Set position (SP) | 90 \pm 5° | 45 \pm 10° |

■ OPERATION ANGLE

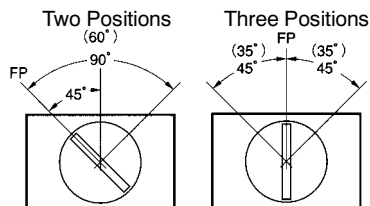

- Note: The angle used for automatic reset is shown in parentheses.

■ CONTACTS

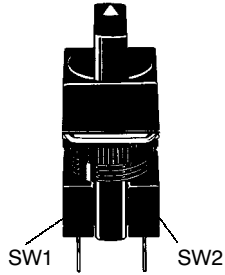

| Position | Contact | | | | |
|-------------|----------|----|----------|-----|-----|
| | SPDT | | DPDT | | |
| | Position | SW | Position | SW1 | SW2 |
| 2 Positions | | | | | |
| | | | | | |
| 3 Positions | — | | | | |
| | | | | | |
| | | | | | |

Dimensions

Unit: mm (inch)

■ KNOB-TYPE SELECTOR SWITCHES WITHOUT TRANSFORMER

Rectangular A165□-J

Solder terminals

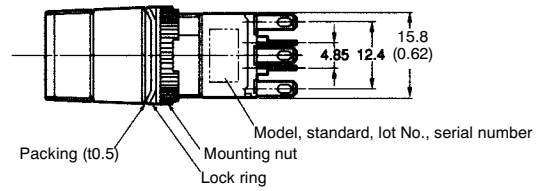
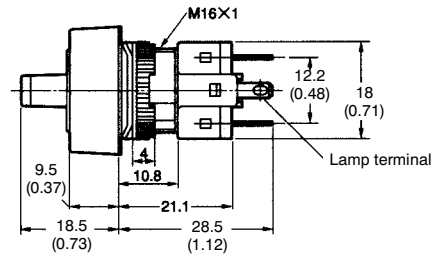
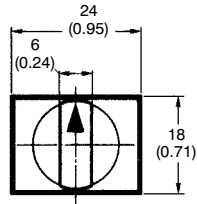
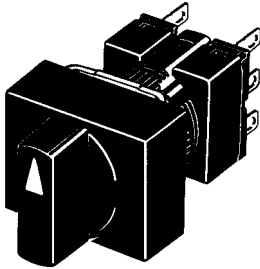

Square A165□-A

Solder terminals

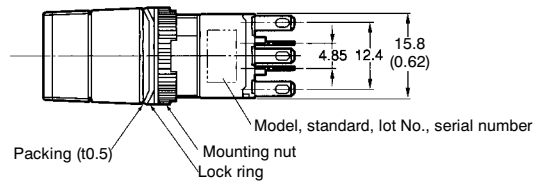
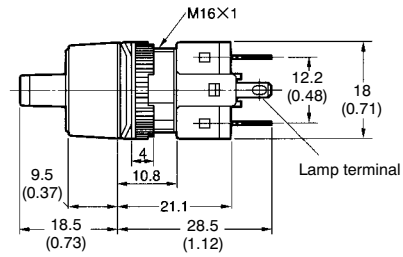
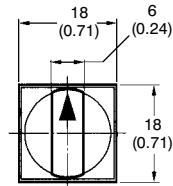
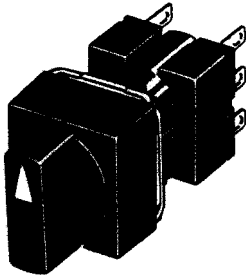

Round A165□-T

Solder terminals

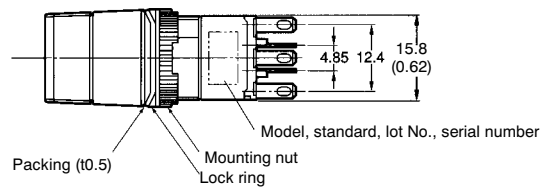
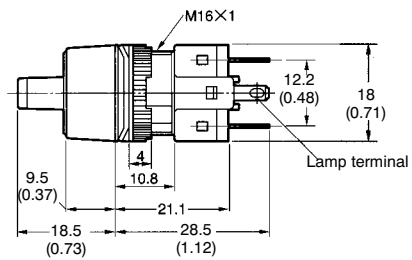
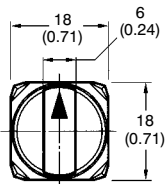
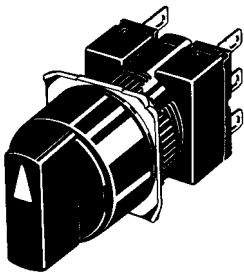

■ PANEL CUTOUTS

**Rectangular
A165□-J**

(Top View)

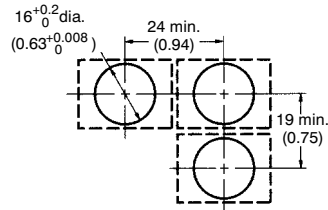

**Square A165□-A
Round A165□-T**

(Top View)

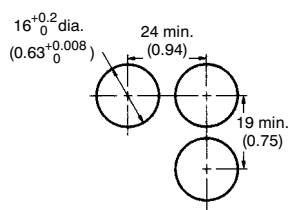

- Note:
1. Make sure the thickness of the mounting panel is between 0.5 and 3.2 mm. If, however, a Switch Guard or Dust Cover is used, the thickness of the mounting panel must be between 0.5 and 2 mm.
 2. If the panel is to be finished with coating, etc., make sure that the panel meets the specified dimensions after coating.

■ TERMINAL ARRANGEMENT

Without Transformer

Lamp terminals are not provided with the Non-illuminated Knob-type Selector Switches and Key-type Selector Switches.

SPDT Switches

Illuminated type

**Dimensions of
Terminal Holes**

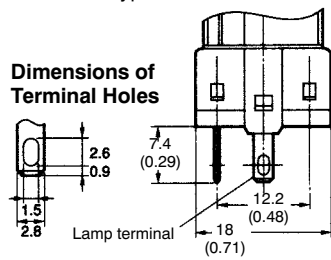

**Terminal Arrangement
(Bottom View)**

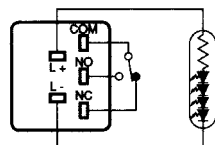

Note: The L+ is not shown on the Switch Unit.

DPDT Switches

Illuminated type

**Dimensions of
Terminal Holes**

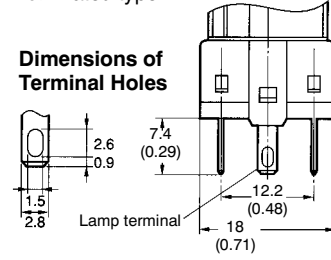

**Terminal Arrangement
(Bottom View)**

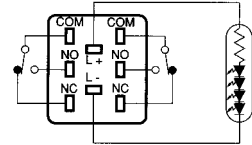

Note: The L+ is not shown on the Switch Unit.

Installation

For details on Panel Mounting, mounting and removing the Switch Unit, refer to installation details for the A16 Pushbutton Switch.

■ FLANGE ROTATION (COMMON TO ALL SELECTOR SWITCHES)

A165 Knob-type Selector Switch

Fix the Switch screw and rotate the flange in 45° turns.

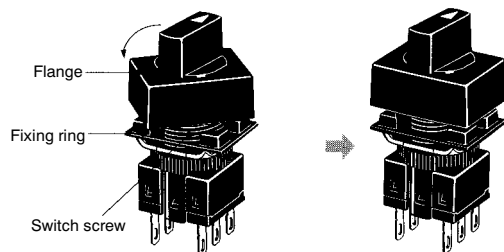

Key-Type Selector Switch

A165K

Mounting Aperture of 16 mm

- Tool-free installation
- 2-piece construction
- Oil-resistant IP65 models
- Short mounting depth, less than 28.5 mm below panel
- Wide range of switching capacity from general to microload
- Maintained and spring return models available
- UL and CSA approved, VDE (pending)
- Conforms to EN60947-5-1, IEC947-5-1

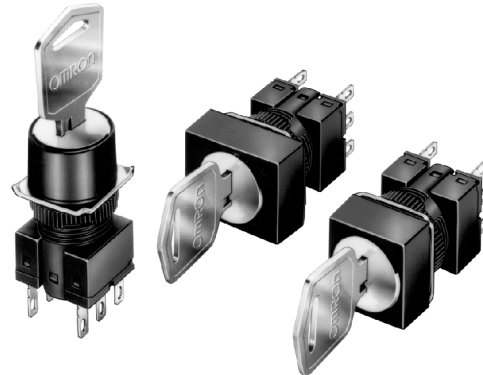

Ordering Information

■ CONSTRUCTION

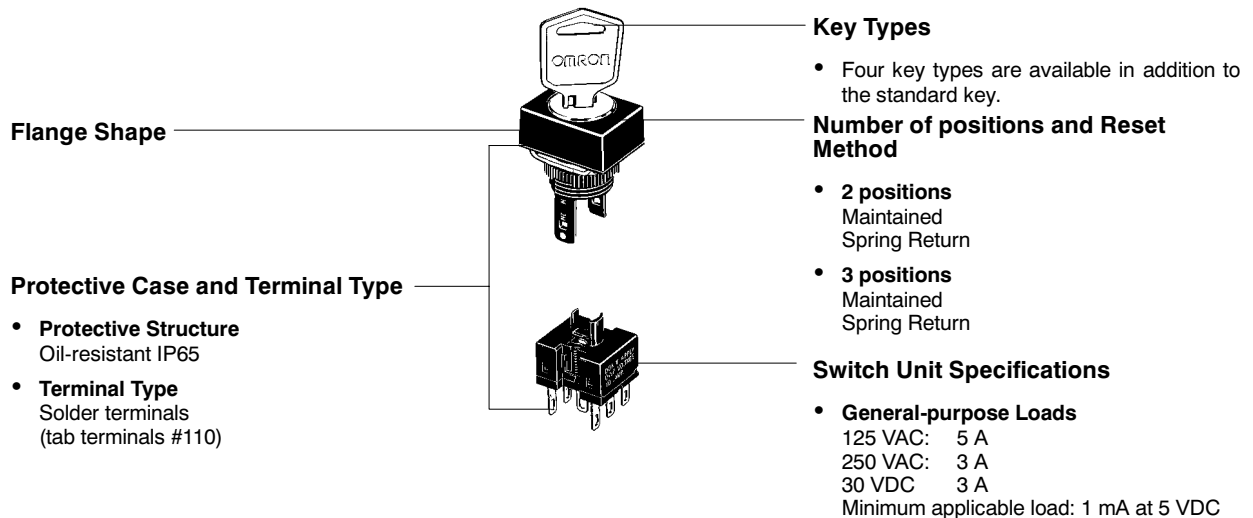

■ PART NUMBER NOMENCLATURE A165K ASSEMBLED KEY-TYPE SELECTOR SWITCH (COMPLETE ASSEMBLY)

A165K-J

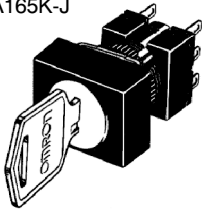

A165K-A

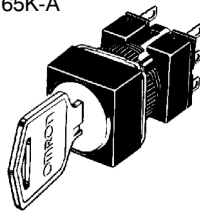

A165K-T

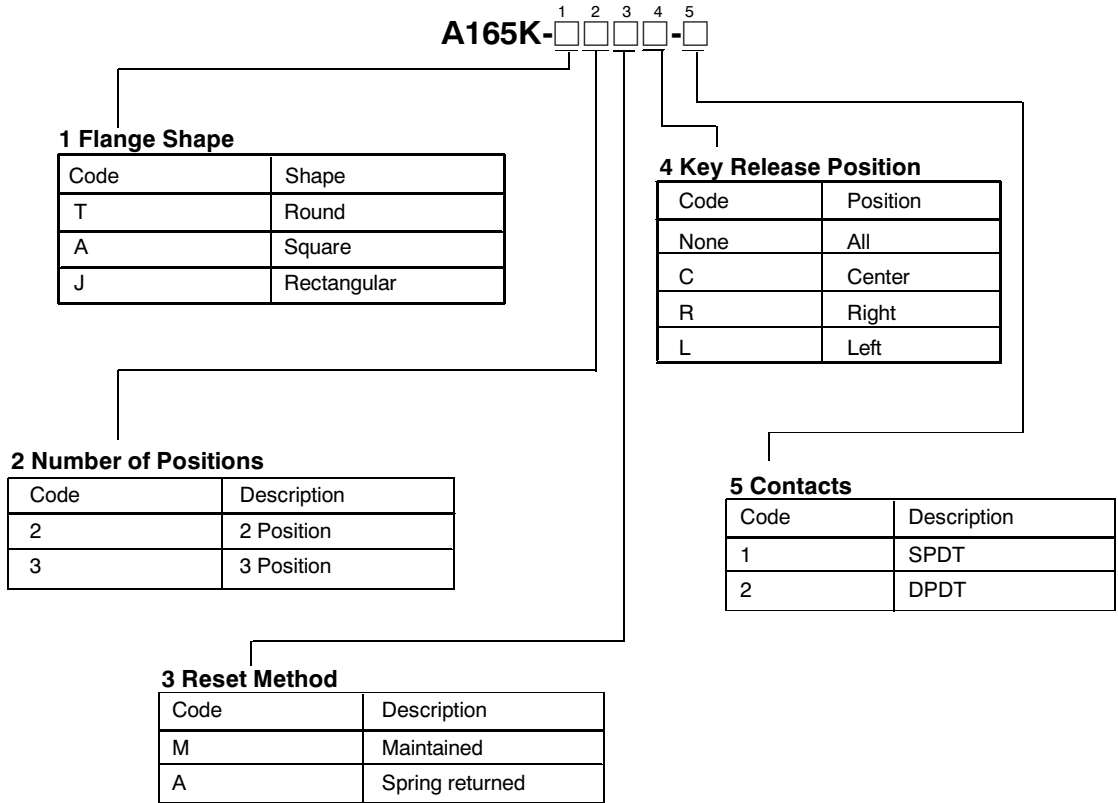
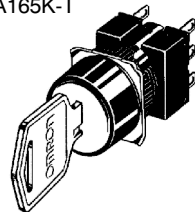

■ PART NUMBERS: NON-ILLUMINATED KEY-TYPE SELECTOR SWITCH (COMPLETE ASSEMBLY)

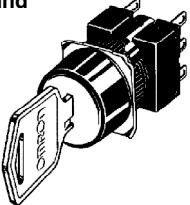
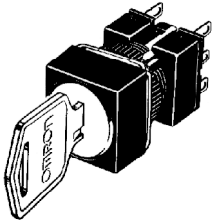
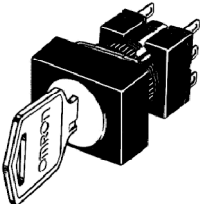
| Shape | Number of positions | Contact | Reset method | Key release position | Part number | |
|---|---------------------|------------|----------------------|-----------------------|--------------|--------------|
| Round  | 2 positions | SPDT | Maintained | Left | A165K-T2ML-1 | |
| | | | | Right | A165K-T2MR-1 | |
| | | | | All | A165K-T2M-1 | |
| | | DPDT | Maintained | Spring return (right) | Left | A165K-T2AL-1 |
| | | | | Left | A165K-T2ML-2 | |
| | | | | Right | A165K-T2MR-2 | |
| | 3 positions | DPDT | Maintained | All | A165K-T2M-2 | |
| | | | | Spring return (right) | Left | A165K-T2AL-2 |
| | | | | Center | A165K-T3MC-2 | |
| | | | | Right | A165K-T3MR-2 | |
| Square  | 2 positions | SPDT | Maintained | Left | A165K-A2ML-1 | |
| | | | | Right | A165K-A2MR-1 | |
| | | | | All | A165K-A2M-1 | |
| | | DPDT | Maintained | Spring return (right) | Left | A165K-A2AL-1 |
| | | | | Left | A165K-A2ML-2 | |
| | | | | Right | A165K-A3MR-2 | |
| | 3 positions | DPDT | Maintained | All | A165K-A2M-2 | |
| | | | | Spring return (right) | Left | A165K-A2AL-2 |
| | | | | Center | A165K-A3MC-2 | |
| | | | | Right | A165K-A3MR-2 | |
| Rectangular  | 2 positions | SPDT | Maintained | Left | A165K-J2ML-1 | |
| | | | | Right | A165K-J2MR-1 | |
| | | | | All | A165K-J2M-1 | |
| | | DPDT | Maintained | Spring return (right) | Left | A165K-J2AL-1 |
| | | | | Left | A165K-J2ML-2 | |
| | | | | Right | A165K-J2MR-2 | |
| | 3 positions | DPDT | Maintained | All | A165K-J2M-2 | |
| | | | | Spring return (right) | Left | A165K-J2AL-2 |
| | | | | Center | A165K-J3MC-2 | |
| | | | | Right | A165K-J3MR-2 | |
| 3 positions | DPDT | Maintained | Left | A165K-J3ML-2 | | |
| | | | All | A165K-J3M-2 | | |
| | | | Spring return (both) | Center | A165K-J3AC-2 | |
| | | | | | | |

Accessories (Order Separately)

■ PANEL PLUGS

| Shape | Classification | Remarks | Part number |
|---|----------------|---|------------------|
|  | Rectangular | Used for covering the panel cutouts for future panel expansion. | A3BJ-3003 |
| | Square | | A3BA-3003 |
| | Round | | A3BT-3003 |

■ TOOLS

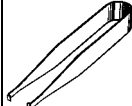
| Name | Shape | Applicable types | | | | | Remarks | Part number |
|---------------|---|-------------------|---------------------------|--------------------------|-----------------------|-----------|--|------------------|
| | | Pushbutton Switch | Knob-type Selector Switch | Key-type Selector Switch | Emergency Stop Switch | Indicator | | |
| Screw fitting |  | Yes | Yes | Yes | Yes | Yes | Convenient for ganged installation. Tighten to a torque of 0.39 N • m (5 kgf • cm) min. | A3B-3004 |
| Extractor |  | Yes | Yes | Yes | Yes | Yes | Convenient for extracting the Switch Unit and Lamps. | A16Z-5080 |

Specifications

■ APPROVED STANDARDS

UL, cUL (File No. E41515)

5 A at 125 VAC, 3 A at 250 VAC (general use)

3 A at 30 VDC (resistive)

EN60947-5-1 (Low Voltage Directive)

■ RATINGS

| AC resistive load | DC resistive load |
|------------------------------|-------------------|
| 3 A, 250 VAC 5 A, 125 VAC | 3 A, 30 VDC |

Minimum applicable load: 1 mA at 5 VDC

Rated values are obtained from tests conducted under the following conditions according to JIS C4505 and C4520.

1. Load: Resistive load
2. Mounting conditions: No vibration and no shock
3. Temperature: 20°±2°C
4. Operating frequency: 20 times/min

■ CONTACT

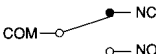
| Name | Contact |
|------|--|
| SPDT |  |

■ CHARACTERISTICS

| Item | Key-type Selector Switch | |
|---------------------------------|---|---|
| Allowable operating frequency | Mechanical | 20 operations/min max. |
| | Electrical | 10 operations/min max. |
| Insulation resistance | 100 MΩ min. (at 500 VDC) | |
| Dielectric strength | 1,000 VAC, 50/60 Hz for 1 min between terminals of same polarity 2,000 VAC, 50/60 Hz for 1 min between terminals of different polarity and also between each terminal and ground | |
| Vibration resistance | Malfuction | 10 to 55 Hz, 1.5-mm double amplitude (malfuction within 1 ms) |
| Shock resistance | Mechanical | 500 m/s ² (50G) |
| | Malfuction | 150 m/s ² (15G) max. (malfuction within 1 ms) |
| Life expectancy | Mechanical | 250,000 operations min. (life of key: 10,000 operations min.) |
| | Electrical | 100,000 operations min. |
| Ambient temperature | Operating: -10°C to 55°C (14°F to 131°F) with no icing or condensation Storage: -25°C to 65°C (-13°F to 149°F) with no icing or condensation | |
| Ambient humidity | Operating: 35% to 85% | |
| Electric shock protection class | Class II | |
| Degree of contamination | 3 (IEC947-5-1) | |
| Weight | Approx. 26.5 g (0.93 oz) in the case of a DPDT switch key | |

Note: Set and reset constitute one operation.

■ OPERATING CHARACTERISTICS

| | Type | Key-type Selector Switch | |
|---------------------------|------|---------------------------|-------------|
| Features | | 2 positions | 3 positions |
| Operating force (OF) max. | | 9.8 N • m (1,000 gf • cm) | |
| Set position (SP) | | 90±5° | 45±10° |

■ OPERATION ANGLE

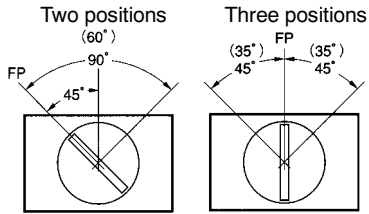

Note: The angle used for automatic reset is shown in parentheses.

■ CONTACTS

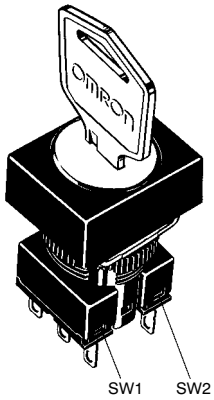

| Position | Contact | | | | |
|-------------|----------|----|----------|-----|-----|
| | SPDT | | DPDT | | |
| | Position | SW | Position | SW1 | SW2 |
| 2 positions | | | | | |
| | | | | | |
| 3 positions | — | | | | |
| | — | | | | |
| | — | | | | |

Dimensions

Unit: mm (inch)

KEY-TYPE SELECTOR SWITCHES

Rectangular A165K-J

Solder terminals

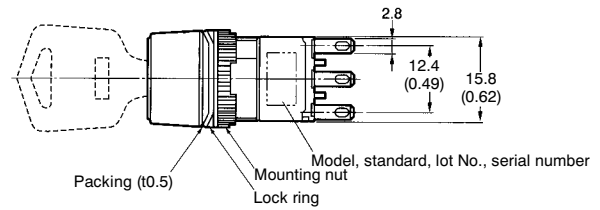
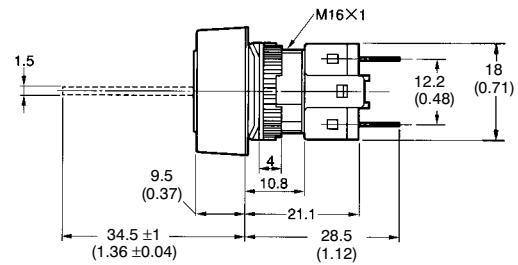
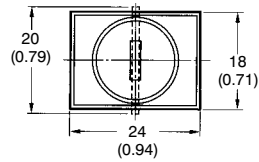
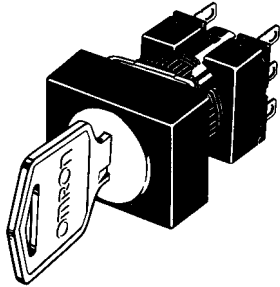

Square A165K-A

Solder terminals

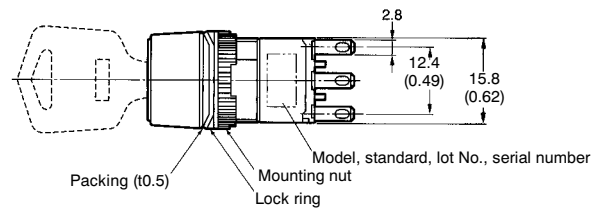
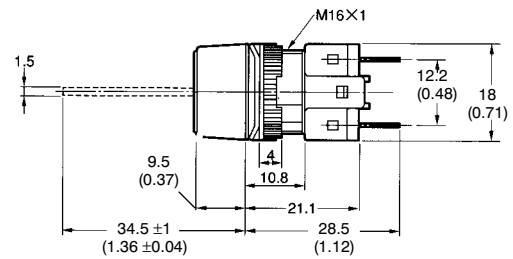
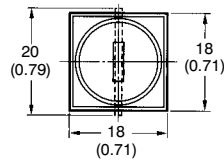
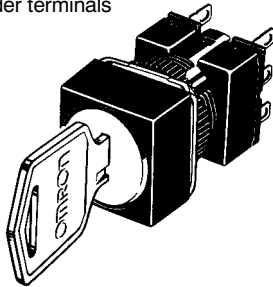

Round A165K-T

Solder terminals

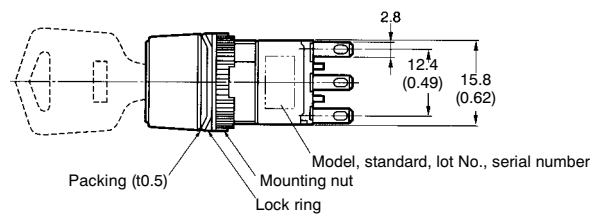
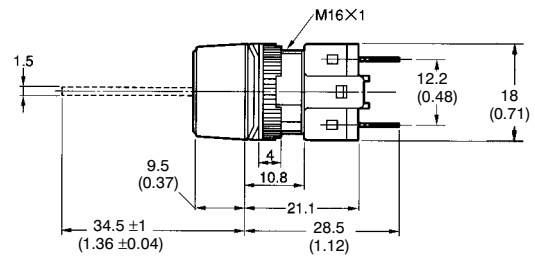
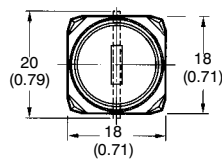
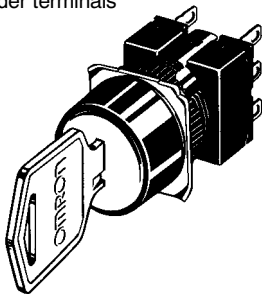

■ PANEL CUTOUTS

Rectangular A165□-J

(Top View)

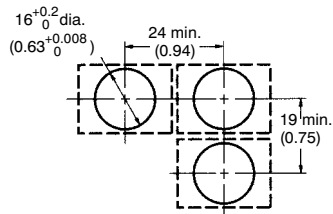

Square A165□-A Round A165□-T

(Top View)

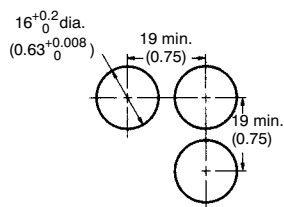

Note: 1. Make sure the thickness of the mounting panel is between 0.5 and 3.2 mm. If, however, a Switch Guard or Dust Cover is used, the thickness of the mounting panel must be between 0.5 and 2 mm.

2. If the panel is to be finished with coating, etc., make sure that the panel meets the specified dimensions after coating.

■ TERMINAL ARRANGEMENT

SPDT Switches

Dimensions of
Terminal Holes

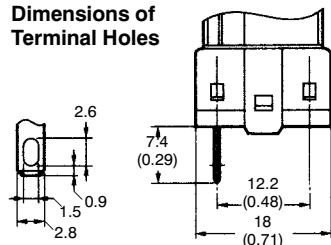

Terminal Arrangement
(Bottom View)

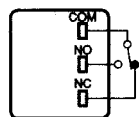

DPDT Switches

Dimensions of
Terminal Holes

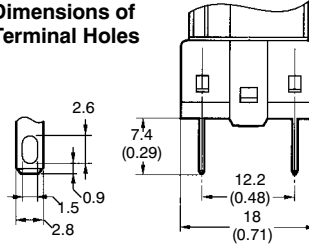

Terminal Arrangement
(Bottom View)

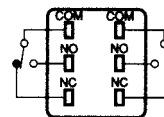

Installation

For mounting and removal instructions refer to the *Installation* section of the A16 Pushbutton switch.

■ FLANGE ROTATION

A165 Key-type Selector Switch

Fix the Switch screw and rotate the flange in 45° turns.

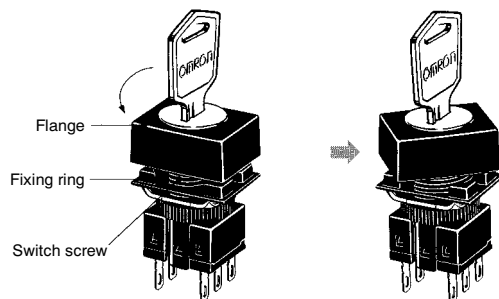

Buzzer

M2BJ-B

16-mm Diameter Panel-Mounted Buzzer Unit



- Four models offer eight different types of sounds, plus two modes newly added to the high-sound type
- Intermittent or continuous sound selected by jumper setting
- Three supply voltages: 6 VAC/DC, 12-24 VDC and 12 to 24 VAC/DC
- Jumper storage provided at bottom of unit
- Complements the A16 range of Pushbuttons, Selector Switches, and Key Switches



Ordering Information

| Item | | Part number | | | | | |
|----------------|-----------------|-------------------|----------------------|-----------------------------|------------------------------------|-----------------------------|----------------------|
| | | Standard sound | | | | High sound | |
| Sound | w/jumper | Intermittent | Intermittent (short) | Intermittent (high-pitched) | Intermittent (short, high-pitched) | Intermittent (high-pitched) | Intermittent (short) |
| | w/o jumper | Continuous | Intermittent (long) | Continuous (high-pitched) | Intermittent (long, high-pitched) | Continuous | Intermittent (long) |
| Supply voltage | 6 VAC/DC | M2BJ-B06 | M2BJ-B06A | M2BJ-B06B | M2BJ-B06C | M2BJ-BH06D | M2BJ-BH06E |
| | 12 to 24 VAC/DC | M2BJ-B24 | M2BJ-B24A | M2BJ-B24B | M2BJ-B24C | M2BJ-BH24D | M2BJ-BH24E |
| | 12 to 24 DC | M2BJ-B24-D | — | M2BJ-B24B-D | — | M2BJ-BH24D-D | M2BJ-BH24E-D |

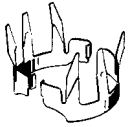
■ ACCESSORIES (ORDER SEPARATELY)

| Name | Shape | Classification | Remarks | Part number |
|------------------------------|---|----------------|---|------------------|
| Snap-in mounting leaf spring |  | — | Cannot be used with mounting nut Panel cutout becomes 16.2 dia. + 0.3, -0 | A3B-3001 |
| Panel plug |  | Rectangular | Reserves hole cut out on panel for future mounting | A3BJ-3003 |
| | | Square | | A3BA-3003 |
| | | Round | | A3BT-3003 |
| Tightening tool |  | — | Useful for mounting buzzers one after another. Do not over-tighten. | A3B-3004 |

Specifications

■ STANDARD-SOUND TYPE

| | | | | | |
|--|-----------------|------------------------------|--|------------------------------|--|
| Rated voltage | 6 VAC/DC | M2BJ-B06 | M2BJ-B06A | M2BJ-B06B | M2BJ-B06C |
| | 12 to 24 VAC/DC | M2BJ-B24 | M2BJ-B24A | M2BJ-B24B | M2BJ-B24C |
| Sound pressure (distance: 0.1 m, at rated voltage) | | Continuous sound: 80 dB min. | Continuous: 80 dB min. | Continuous sound: 80 dB min. | Continuous: 80 dB min. |
| Driving frequency | | 2±0.5 kHz | | 4±0.5 kHz | |
| Intervals | | 190 times/minute±10% | Long: 55 times/minute±10% Short: 700 times/minute±10% | 190 times/minute±10% | Long: 55 times/minute±10% Short: 700 times/minute±10% |
| Current consumption | DC | 7 mA | 7 mA | 20 mA | 20 mA |
| | AC | 20 mA | 20 mA | 20 mA | 20 mA |
| Life expectancy | | 1,000 hours min. | | | |

■ HIGH-SOUND TYPE

| | | | | | | |
|---|---------------------------------|-----------------|--|-----------------|------------------------|--|
| Item | High-sound type | | | | | |
| | M2BJ-BH06D | M2BJ-BH24D | M2BJ-BH06E | M2BJ-BH24E | M2BJ-BH24D-D | M2BJ-BH24E-D |
| Rated voltage | 6 VAC/DC | 12 to 24 VAC/DC | 6 VAC/DC | 12 to 24 VAC/DC | 12 to 24 VDC | |
| Sound pressure (adjustable range) (rated voltage, distance of 0.1 m, A range) | 70 to 100 dB (Adjustable range) | | | | | |
| Driving frequency | 2.8±0.5 kHz | | | | | |
| Intervals | Approx. 190 times/min. | | Long: Approx. 55 times/min. Short: Approx. 700 times/min. | | Approx. 190 times/min. | Long: Approx. 55 times/min. Short: Approx. 700 times/min. |
| Current consumption | DC | 50 mA max. | | | | |
| | AC | 100 mA max. | | | — | |
| Inrush current | 1 A max. | | | | | |
| Life expectancy | 1,000 hours min. | | | | | |

■ CHARACTERISTICS

| | |
|-----------------------|---|
| Insulation resistance | 100 MΩ min. (between ground and current-carrying parts) |
| Dielectric strength | 1,000 VAC for 1 minute (between grounds) |
| Ambient temperature | Operating: -10°C to 55°C (14°F to 131°F) with no icing or condensation Storage: -25°C to 65°C (-13°F to 149°F) with no icing or condensation |
| Humidity | 35% to 85% RH |

Dimensions

Unit: mm (inch)

M2BJ-B

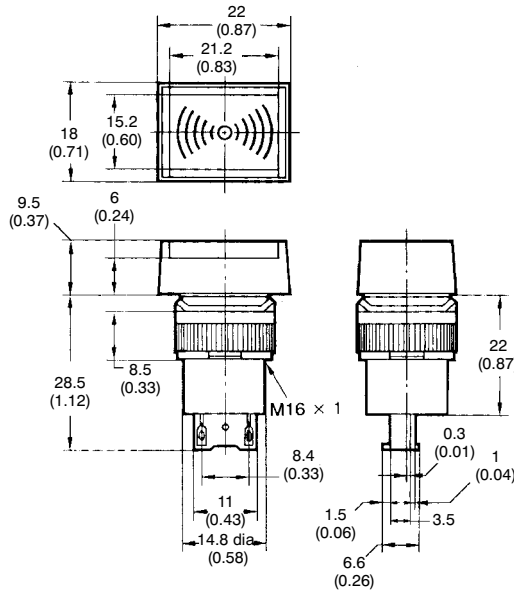
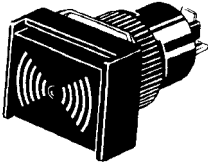

Panel cutout (Top view)

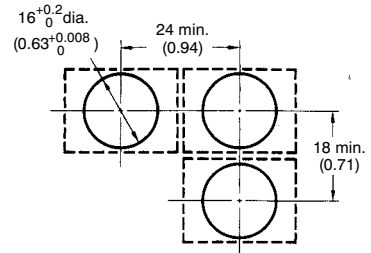

M2BJ-BH

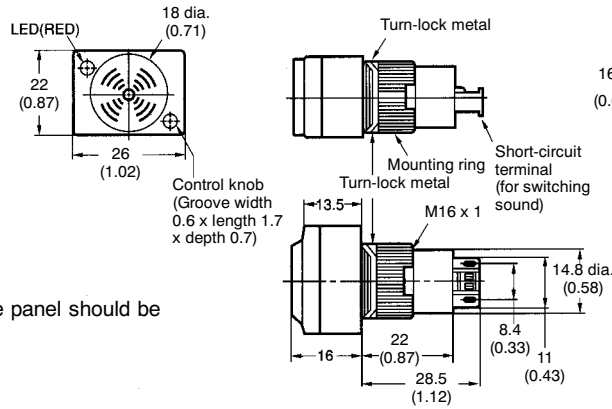
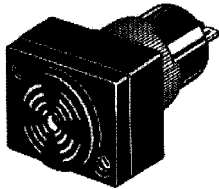

Panel cutout*

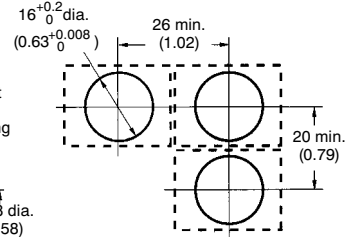

Note: Plate thickness of the panel should be 1.0 to 3.2 mm.

Unit: mm (inch)

■ ACCESSORIES

Tightening Tool

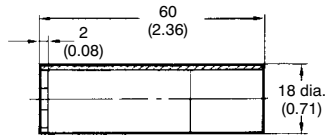
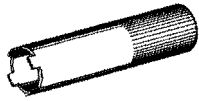

Panel Plug

Select a panel plug which best compliments the design of the mounting panel. The dimensions of the hole cutout for the panel plugs are the same as those of the buzzer unit.

Rectangular

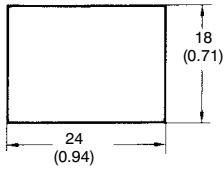

Square

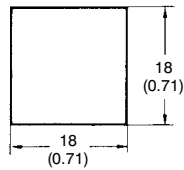

Round

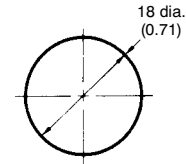

Correct Use

■ NUT MOUNTING

Insert the buzzer unit from the front of the panel and tighten the mounting nut inserted from the rear of the panel.

Since a projection exists on the rear portion of the buzzer unit, if the mounting nut cannot be fitted into position, turn the nut slightly.

The tightening torque of the mounting nut should be less than 5 kg-cm.

Solder the terminals after mounting the nut. Otherwise, the terminals, when thickened by solder, may prevent the nut from being screwed down onto the buzzer unit.

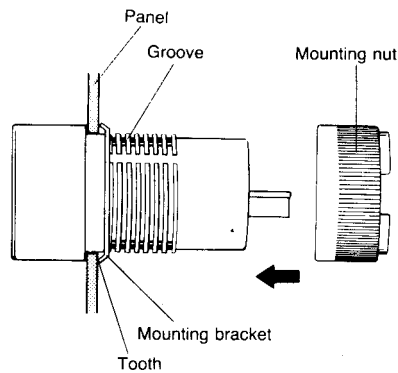

■ MOUNTING

Tighten the mounting nut at a torque of less than 5 kg-cm.

■ WIRING

Exercise caution that the input terminals are not short-circuited by the short-circuiting jumper.

Finish soldering within 5 seconds with a 30 watt soldering iron, or within 3 seconds at a solder temperature of 240°C. For about a minute after soldering, do not apply any force to the buzzer unit, to avoid deforming the softened plastic buzzer unit base.

Use a non-corrosive, resin-based soldering flux.

■ SNAP-IN MOUNTING

Attach the mounting leaf spring to the buzzer. Engage the edges of the leaf spring in the two grooves on the threaded section of the buzzer. After inserting the leaf spring edges into the grooves, confirm that the leaf spring has seated. Be sure to attach both leaf springs.

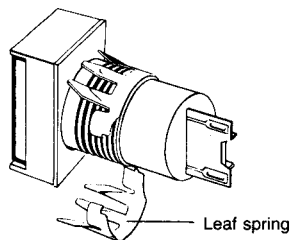

Insert the buzzer assembly into the hole on the mounting panel from the front.

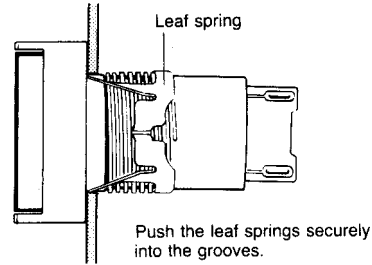

■ SHORT-CIRCUITING JUMPER

The buzzer sounds continuously or intermittently depending on how the short-circuiting bracket is attached to the case guide. When the bracket is attached with the triangle on it facing direction A (PC board side), the buzzer sounds intermittently.

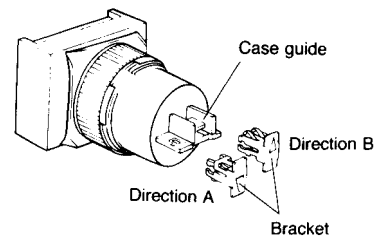

To produce continuous sounds, attach the bracket to the case guide so that the triangle on the bracket faces direction B.

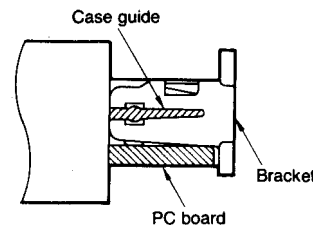

NOTE: DIMENSIONS SHOWN ARE IN MILLIMETERS. To convert millimeters to inches divide by 25.4.

OMRON[®]
OMRON ELECTRONICS LLC
One East Commerce Drive
Schaumburg, IL 60173
1-800-55-OMRON

OMRON ON-LINE
Global - <http://www.omron.com>
USA - <http://www.omron.com/oei>
Canada - <http://www.omron.com/oci>

OMRON CANADA, INC.
885 Milner Avenue
Scarborough, Ontario M1B 5V8
416-286-6465