

Solid State Relays G3PA

Extremely Thin Relays Integrated with Heat Sinks

- Downsizing achieved through optimum design of heat sink.
- Mounting possible via screws or via DIN track.
- Close mounting possible for linking terminals. (Except for G3PA-260B-VD and G3PA-450B-VD-2.)
- Applicable with 3-phase loads.
- Replaceable power element cartridges.
- Complies with VDE 0160 (finger protection), with a dielectric strength of 4,000 V between input and load.
- Complies with VDE 0805, IEC 950.
- Certified by UL, CSA, and VDE (reinforced insulation).



Ordering Information

List of Models

To Order: Select the part number and add the rated input voltage range. (e.g., G3PA-430B-VD-2 DC12-24)

| Isolation | Zero cross function | Indicator | Rated output load | Rated input voltage | Model |
|------------------------|---------------------|-----------|------------------------|---------------------|----------------|
| Phototriac coupler | Yes | Yes | 10 A at 24 to 240 VAC | 5 to 24 VDC | G3PA-210B-VD |
| | | | 20 A at 24 to 240 VAC | | G3PA-220B-VD |
| | | | 40 A at 24 to 240 VAC | | G3PA-240B-VD |
| | | | 60 A at 24 to 240 VAC | | G3PA-260B-VD |
| | No | | 10 A at 24 to 240 VAC | | G3PA-210BL-VD |
| | | | 20 A at 24 to 240 VAC | | G3PA-220BL-VD |
| | | | 40 A at 24 to 240 VAC | | G3PA-240BL-VD |
| | | | 60 A at 24 to 240 VAC | | G3PA-260BL-VD |
| | Yes | | 10 A at 24 to 240 VAC | 24 VAC | G3PA-210B-VD |
| | | | 20 A at 24 to 240 VAC | | G3PA-220B-VD |
| | | | 40 A at 24 to 240 VAC | | G3PA-240B-VD |
| | | | 60 A at 24 to 240 VAC | | G3PA-260B-VD |
| | | | 20 A at 180 to 400 VAC | 12 to 24 VDC | G3PA-420B-VD |
| | | | 30 A at 180 to 400 VAC | | G3PA-430B-VD |
| | | | 20 A at 200 to 480 VAC | | G3PA-420B-VD-2 |
| | | | 30 A at 200 to 480 VAC | | G3PA-430B-VD-2 |
| 50 A at 200 to 480 VAC | G3PA-450B-VD-2 | | | | |

Replacement Parts

| Name | Carry current | Load voltage range | Applicable SSR | Model | VDE certification |
|------------------------|---------------|----------------------|------------------------|------------------------|-------------------|
| Power Device Cartridge | 10 A | 19 to 264 VAC | G3PA-210B-VD DC5-24 | G32A-A10-VD DC5-24 | Yes |
| | | | G3PA-210BL-VD DC5-24 | G32A-A10L-VD DC5-24 | |
| | | | G3PA-210B-VD AC24 | G32A-A10-VD AC24 | |
| | 20 A | | G3PA-220B-VD DC5-24 | G32A-A20-VD DC5-24 | |
| | | | G3PA-220BL-VD DC5-24 | G32A-A20L-VD DC5-24 | |
| | | | G3PA-220B-VD AC24 | G32A-A20-VD AC24 | |
| | 40 A | | G3PA-240B-VD DC5-24 | G32A-A40-VD DC5-24 | |
| | | | G3PA-240BL-VD DC5-24 | G32A-A40L-VD DC5-24 | |
| | | | G3PA-240B-VD AC24 | G32A-A40-VD AC24 | |
| | 60 A | G3PA-260B-VD DC5-24 | G32A-A60-VD DC5-24 | | |
| | | G3PA-260BL-VD DC5-24 | G32A-A60L-VD DC5-24 | | |
| | | G3PA-260B-VD AC24 | G32A-A60-VD AC24 | | |
| | 20 A | 150 to 440 VAC | G3PA-420B-VD DC12-24 | G32A-A420-VD DC12-24 | |
| | 30 A | | G3PA-430B-VD DC12-24 | G32A-A430-VD DC12-24 | |
| | 20 A | 180 to 528 VAC | G3PA-420B-VD-2 DC12-24 | G32A-A420-VD-2 DC12-24 | |
| | 30 A | | G3PA-430B-VD-2 DC12-24 | G32A-A430-VD-2 DC12-24 | |
| | 50 A | | G3PA-450B-VD-2 DC12-24 | G32A-A450-VD-2 DC12-24 | |

Specifications

■ Ratings (at an Ambient Temperature of 25°C)

Input

| Model | Rated voltage | Operating Voltage range | Input current impedance | Voltage level | |
|------------------|---------------|-------------------------|-------------------------|----------------------|----------------------|
| | | | | Must operate voltage | Must release voltage |
| G3PA-2□□B-VD | 5 to 24 VDC | 4 to 30 VDC | 7 mA max. | 4 VDC max. | 1 VDC min. |
| G3PA-2□□BL-VD | | | 20 mA max. | | |
| G3PA-2□□B-VD | 24 VAC | 19.2 to 26.4 VAC | 1.4 kΩ±20% | 19.2 VAC max. | 4.8 VAC min. |
| G3PA-4□□B-VD(-2) | 12 to 24 VDC | 9.6 to 30 VDC | 7 mA max. | 9.2 VDC max. | 1 VDC min. |

Output

| Model | Applicable load | | | |
|-----------------|---------------------------|---------------------------|--------------|------------------------|
| | Rated load voltage | Load voltage range | Load current | Inrush current |
| G3PA-210B(L)-VD | 24 to 240 VAC (50/60 Hz) | 19 to 264 VAC (50/60 Hz) | 0.1 to 10 A | 150 A (60 Hz, 1 cycle) |
| G3PA-220B(L)-VD | | | 0.1 to 20 A | 220 A (60 Hz, 1 cycle) |
| G3PA-240B(L)-VD | | | 0.5 to 40 A | 440 A (60 Hz, 1 cycle) |
| G3PA-260B(L)-VD | | | 0.5 to 60 A | 440 A (60 Hz, 1 cycle) |
| G3PA-420B-VD | 180 to 400 VAC (50/60 Hz) | 150 to 440 VAC (50/60 Hz) | 0.5 to 20 A | 220 A (60 Hz, 1 cycle) |
| G3PA-430B-VD | | | 0.5 to 30 A | 440 A (60 Hz, 1 cycle) |
| G3PA-420B-VD-2 | 200 to 480 VAC (50/60 Hz) | 180 to 528 VAC (50/60 Hz) | 0.5 to 20 A | 220 A (60 Hz, 1 cycle) |
| G3PA-430B-VD-2 | | | 0.5 to 30 A | 440 A (60 Hz, 1 cycle) |
| G3PA-450B-VD-2 | | | 0.5 to 50 A | 440 A (60 Hz, 1 cycle) |

Refer to *Engineering Data* for further details.

■ Characteristics

| Item | G3PA-210B(L)-VD | G3PA-220B(L)-VD | G3PA-240B(L)-VD | G3PA-260B(L)-VD | G3PA-420B-VD | G3PA-420B-VD-2 | G3PA-430B-VD | G3PA-430B-VD-2 | G3PA-450B-VD-2 |
|------------------------|---|-----------------|--|-----------------|--------------------------------------|--|--------------------------------------|--|------------------------|
| Operate time | 1/2 of load power source cycle + 1 ms max. (DC Input, -B models) 1 1/2 of load power source cycle + 1 ms max. (AC Input) 1 ms max. (-BL models) | | | | | | | | |
| Release time | 1/2 of load power source cycle + 1 ms max. (DC Input) 1 1/2 of load power source cycle + 1 ms max. (AC Input) | | | | | | | | |
| Output ON voltage drop | 1.6 V (RMS) max. | | | | 1.8 V (RMS) max. | | | | |
| Leakage current | 5 mA max. (at 100 VAC) 10 mA max. (at 200 VAC) | | 10 mA max. (at 100 VAC) 20 mA max. (at 200 VAC) | | 20 mA max. (at 400 VAC) | 20 mA max. (at 480 VAC) | 20 mA max. (at 400 VAC) | 20 mA max. (at 480 VAC) | |
| I ² t | 260 A ² s | | 1,260 A ² s | | 260 A ² s | 1,800 A ² s | 1,800 A ² s | | 1,800 A ² s |
| Insulation resistance | 100 MΩ min. (at 500 VDC) | | | | | | | | |
| Dielectric strength | 4,000 VAC, 50/60 Hz for 1 min | | | | | | | | |
| Vibration resistance | Malfunction: 10 to 55, 0.75-mm double amplitude (Mounted to DIN track) | | | | | | | | |
| Shock resistance | Malfunction: 300 m/s ² (mounted to DIN track) | | | | | | | | |
| Ambient temperature | Operating: -30°C to 80°C (with no icing or condensation) Storage: -30°C to 100°C (with no icing or condensation) | | | | | | | | |
| Certified standards | UL, CSA, EN60950 File No. 5915ÜG | | | | UL, CSA, EN60947-4-3 File No. 6642ÜG | UL, CSA, EN60947-4-3 File No. 133127ÜG | UL, CSA, EN60947-4-3 File No. 6642ÜG | UL, CSA, EN60947-4-3 File No. 133127ÜG | |
| Ambient humidity | Operating: 45% to 85% | | | | | | | | |
| Weight | Approx. 260 g | Approx. 340 g | Approx. 460 g | Approx. 900 g | Approx. 290 g | Approx. 290 g | Approx. 410 g | Approx. 410 g | Approx. 900 g |

Operation

■ Replacement Parts

G32A-A Power Device Cartridge

The G32A-A Power Device Cartridge (a Triac Unit) can be replaced with a new one. When the temperature indicator has changed from pink to red, the triac circuitry may have malfunctioned possibly by an excessive flow of current, in which case, dismount the damaged cartridge for replacement.

The damaged cartridge can be replaced with a new one without disconnecting the wires from the G3PA.

Improve the heat radiation efficiency of the G3PA before replacing the cartridge.

The G32A-A Power Device Cartridge can withstand an excessive current for a short period of time, such as may be caused accidentally by the short circuitry of the load, in which case the temperature indicator will not turn red.

Be sure to turn OFF the power supply when replacing the Cartridge. Supplying power with the Cartridge removed may result in malfunction.

Appearance

G32A-A10(L)-VD G32A-A20(L)-VD G32A-A40(L)-VD G32A-A60(L)-VD

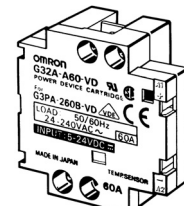
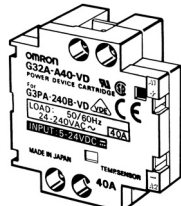
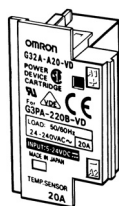
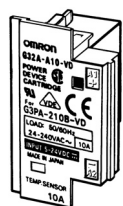

G32A-A420-VD(-2) G32A-A430-VD(-2) G32A-A450-VD-2

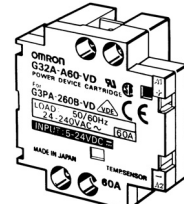
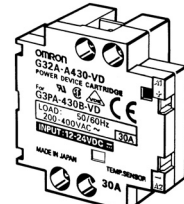
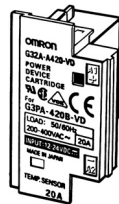

Replacing Power Device Cartridges

When replacing Power Device Cartridges, use the specified model. Using a Power Device Cartridge other than the specified one will result in faulty operation and destruction of the elements.

■ Replacement Procedure

G32A-A10(L)-VD/G32A-A20(L)-VD/G32-A420-VD(-2)

Use the special tool (provided) to extract the cartridge for replacement with a new one.

Extraction

Follow the procedures below to remove the Power Device Cartridge from the G3PA.

1. **Switch off the power.**
2. Remove the terminal cover.
3. Hook the indented part of the cartridge with the tool (supplied with a new cartridge) and pull up on the cartridge to remove it.

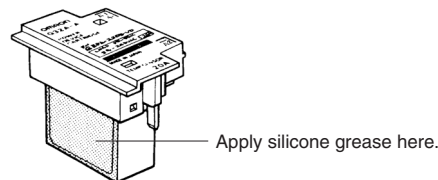
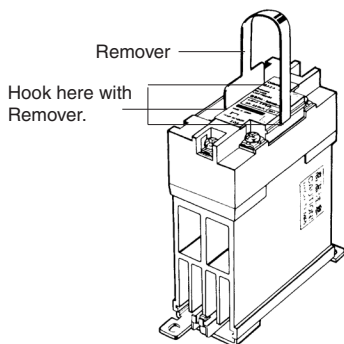

2. Make sure that there is no dust or pieces of wire on the heat sink of the G32A-A or the G3PA.
3. Insert the cartridge into the opening of the G3PA so that the letters on the cartridge and those on the G3PA are in the same direction and side A and side B are even.

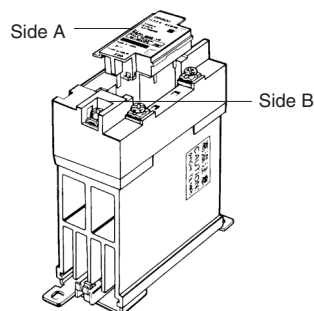

Installation

Follow the procedures below to Install the Power Device Cartridge on the G3PA.

1. Apply silicone grease (provided with the G32A-A) to the entire surface of the heat sink.

4. Attach the terminal cover.
5. Switch on the power and check the G3PA to be sure it works properly.

G32A-A40(L)-VD/G32A-A60(L)-VD/G32A-A430-VD(-2)/G32A-A450-VD-2

The G32A Power Device Cartridge is mounted and secured with screws to the G3PA Unit.

Extraction

Follow the procedures below to remove the G32A-A Power Device Cartridge from the G3PA.

1. **Switch off the power.**
2. Remove the terminal cover.
3. Loosen the two centered screws on the sides to dismount the cartridge. The screws are connected to terminals 1 and 2.

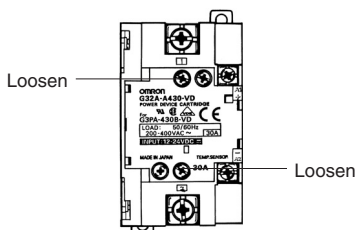

4. Loosen the screws on both the corners.

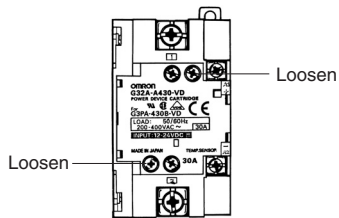

5. Hold the indented part of both the corners to remove the cartridge.

Installation

Follow the procedures below to Install the Power Device Cartridge on the G3PA.

1. Apply silicone grease to the entire surface of the heat sink.

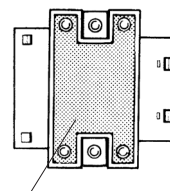

2. Make sure that there is no dust or pieces of wire on the heat sink of the G32A-A or the G3PA.

3. Insert the cartridge into the opening of the G3PA so that side A and side B are even.

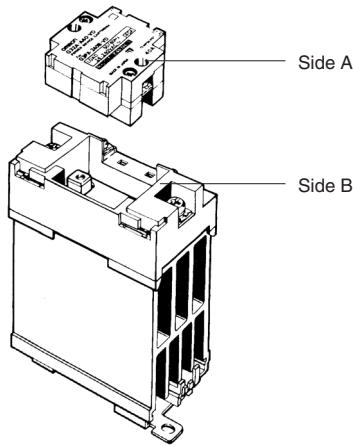

4. Tighten the screws on both the corners with a tightening torque of 0.59 to 0.78 N•m.
5. Tighten the screws on both the sides with a tightening torque of 0.59 to 0.78 N•m.
6. Attach the terminal cover.
7. Switch on the power and check the G3PA to be sure it works properly.

■ Linking Terminal Connection

- Connecting with linking terminal for G3PA-210B(L)-VD, -220B(L)-VD, -240B(L)-VD and G3PA-420B-VD(-2), G3PA-430B-VD(-2).

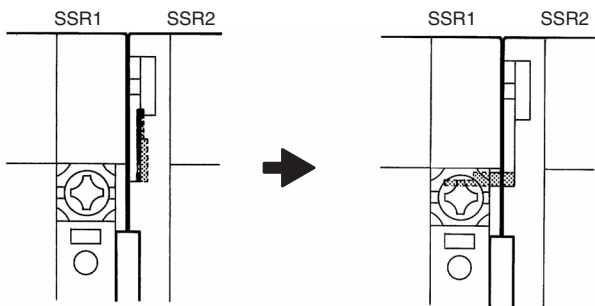

1. When SSRs are close mounted, loosen the M3.5 Sems screw and flip the linking terminal down.

2. Insert the linking terminal securely into the center of the screw and tighten the screw.

- Connecting with linking terminal to "G32A-D" series short circuit unit. (Order short circuit units separately.)

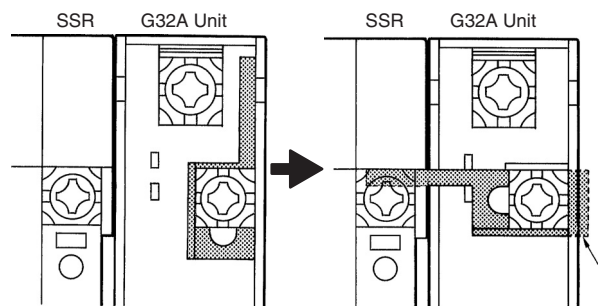

1. When SSR are close mounted, loosen the M3.5 Sems screw on the G32A and flip the linking terminal down.

* The cover will not fit if the terminal protrudes.

2. Insert the linking terminal securely into the center of the screw. Ensure that the linking terminal does not protrude.

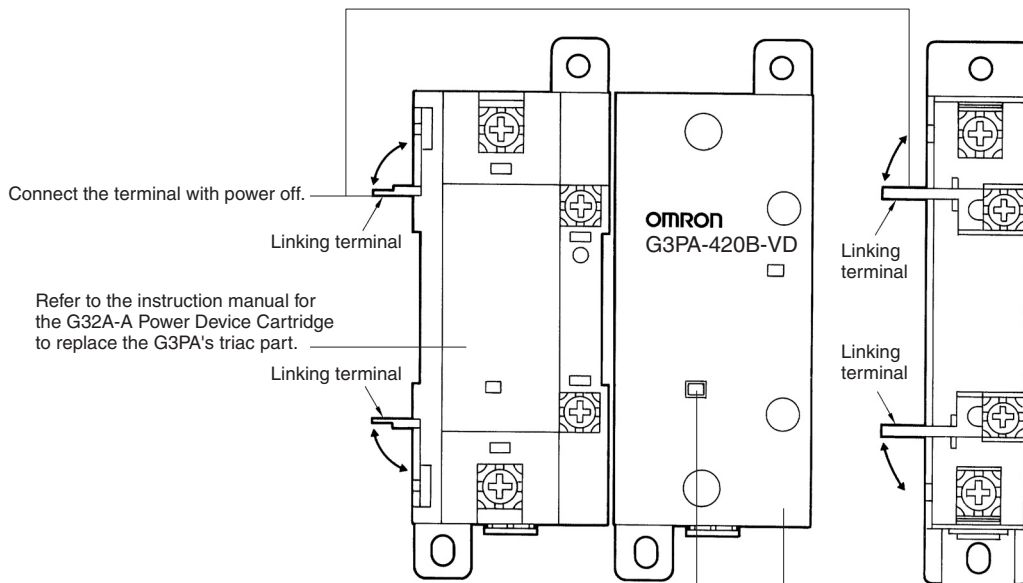

When the temperature indicator has turned from pink to red, the G32A-A Power Device Cartridge may have malfunctioned, in which case the cartridge must be replaced with a new one.

Use the terminal cover to prevent accidents due to electric shock.

Engineering Data

Load Current vs. Ambient Temperature

Vertical Mounting

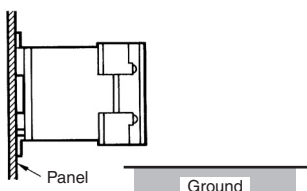

G3PA-210B(L)-VD, G3PA-220B(L)-VD

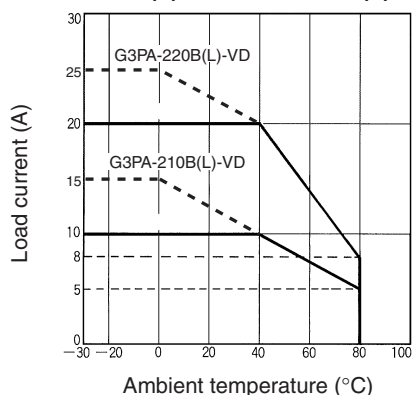

G3PA-240B(L)-VD

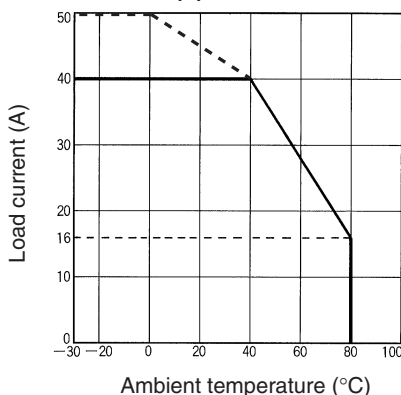

G3PA-260B(L)-VD

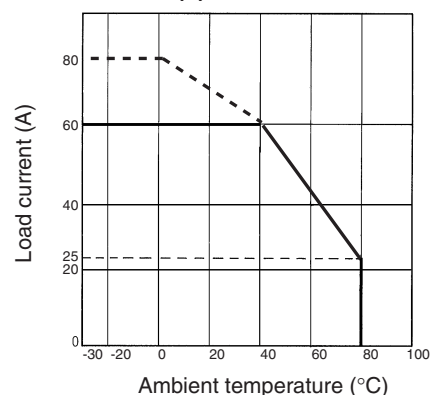

G3PA-420B-VD, G3PA-420B-VD-2

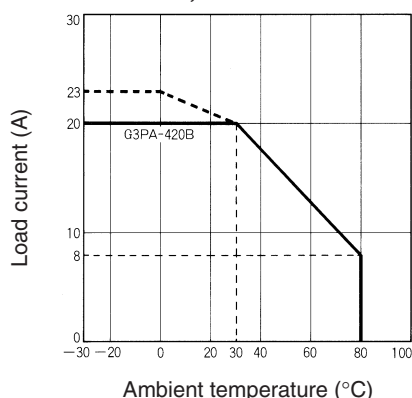

G3PA-430B-VD, G3PA-430B-VD-2

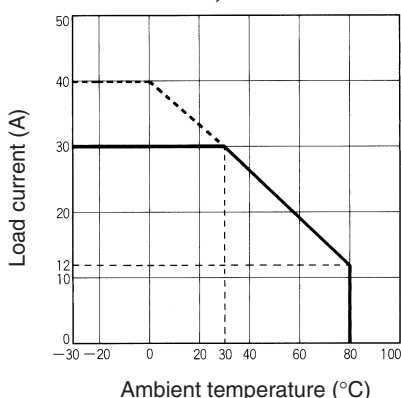

G3PA-450B-VD-2

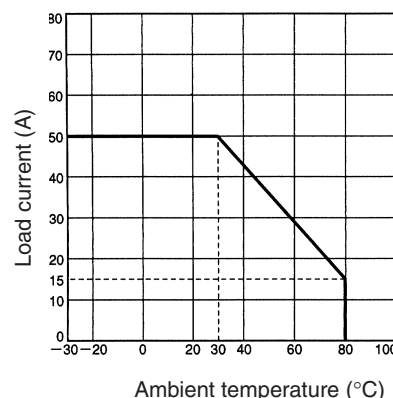

Note: Close mounting is possible for a maximum of three Units by reducing the load current by 20%. (A minimum clearance of 10 mm must be provided when mounting four or more Units.)

Input Voltage vs. Input Current

G3PA-2□0B-VD

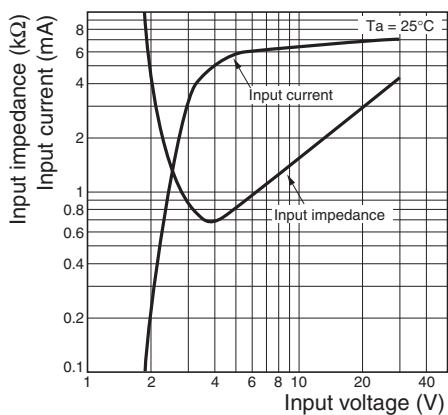

G3PA-4□0-VD, G3PA-4□-VD-2

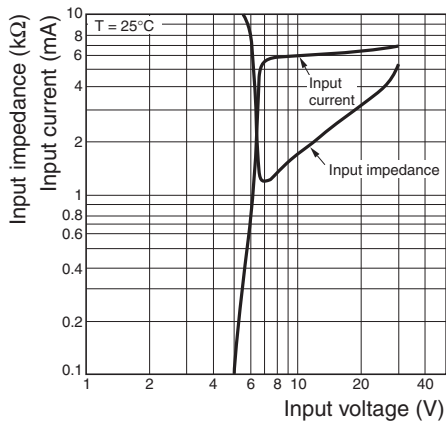

Horizontal Mounting

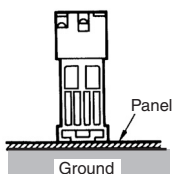

G3PA-210B(L)-VD, G3PA-220B(L)-VD

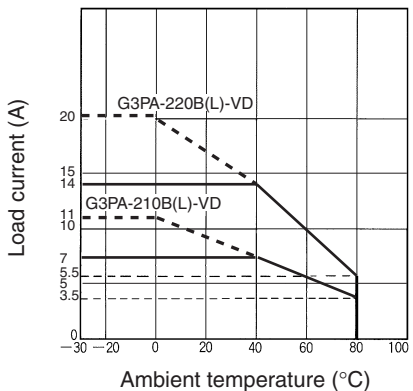

G3PA-240B(L)-VD

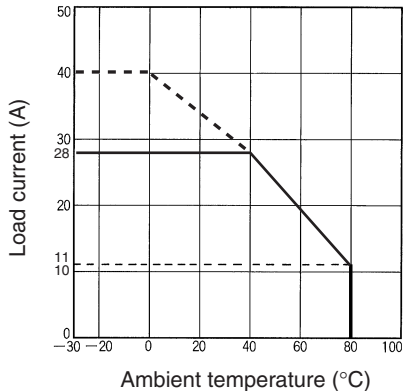

G3PA-260B(L)-VD

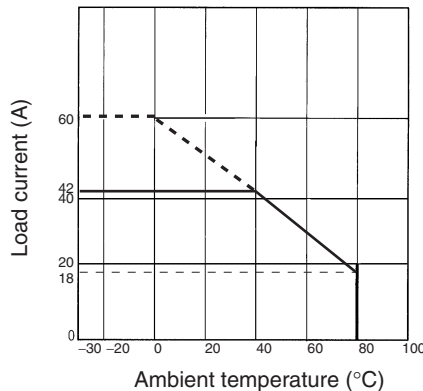

G3PA-420B-VD, G3PA-430B-VD
G3PA-420B-VD-2, G3PA-430B-VD-2

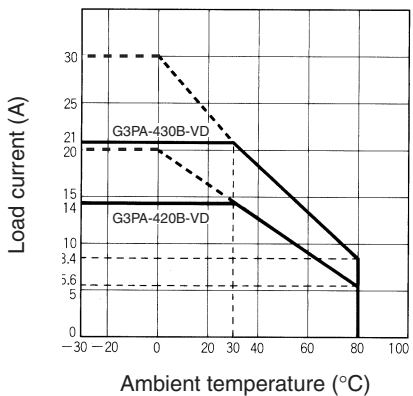

G3PA-450B-VD-2

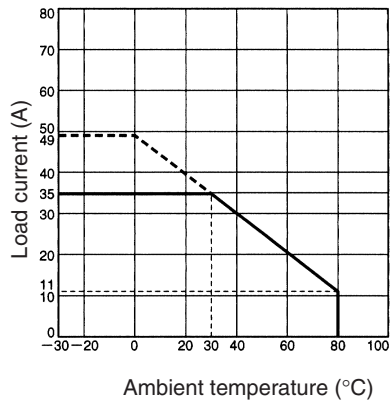

Close Mounting (Up to Three)

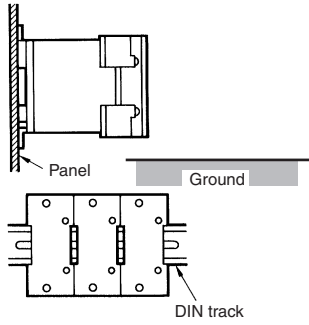

G3PA-210B(L)-VD, G3PA-220B(L)-VD

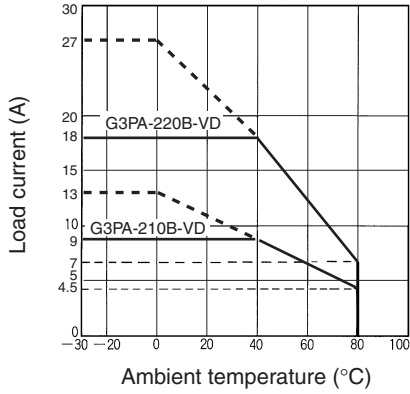

G3PA-240B(L)-VD

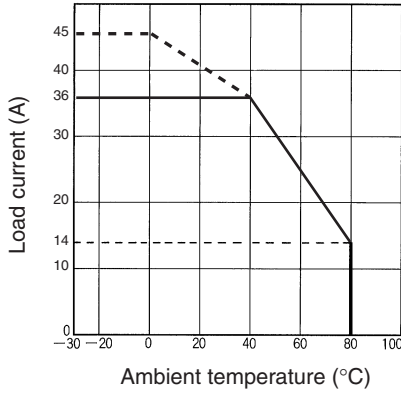

G3PA-260B(L)-VD

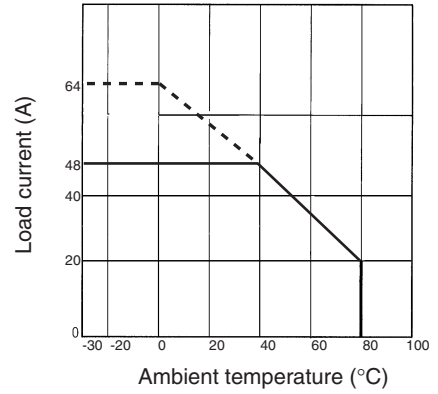

G3PA-420B-VD, G3PA-420B-VD-2

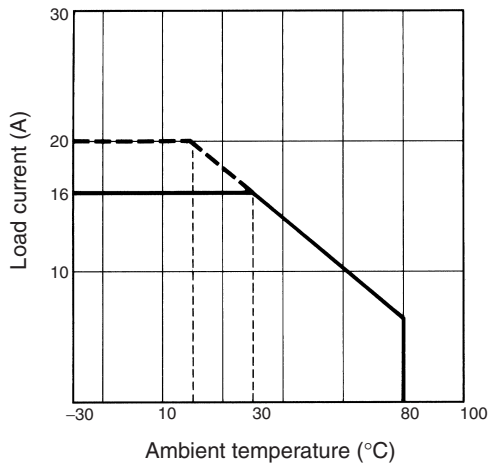

G3PA-430B-VD, G3PA-430B-VD-2

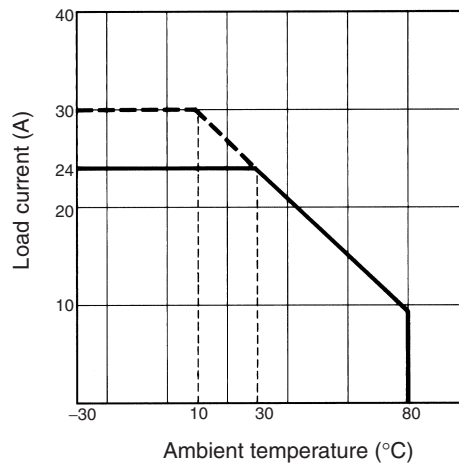

G3PA-450B-VD-2

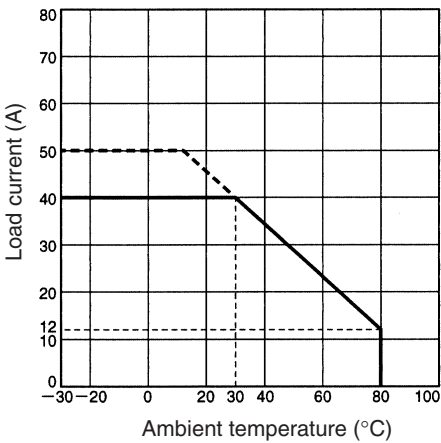

Inrush Current Resistivity

One cycle, non-repetitive (Keep the inrush current to half the rated value if it occurs repetitively.)

G3PA-210B(L)-VD

**G3PA-220B(L)-VD, G3PA-420B-VD,
G3PA-420B-VD-2**

**G3PA-240B(L)-VD/260B(L)-VD,
G3PA-430B-VD, G3PA-430B-VD-2,
G3PA-450B-VD-2**

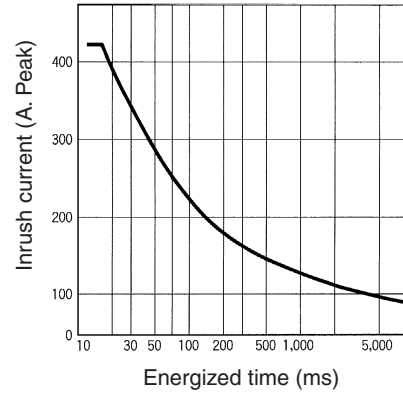
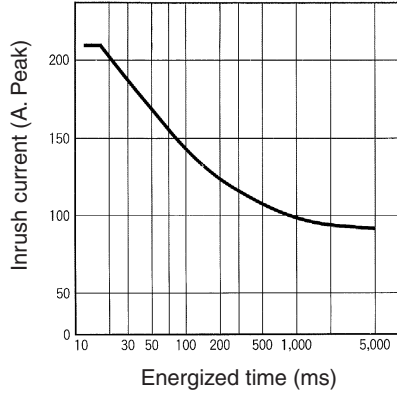
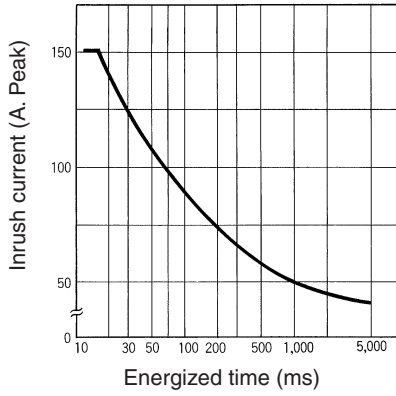

Dimensions

Note: All units are in millimeters unless otherwise indicated.

G3PA-210B(L)-VD

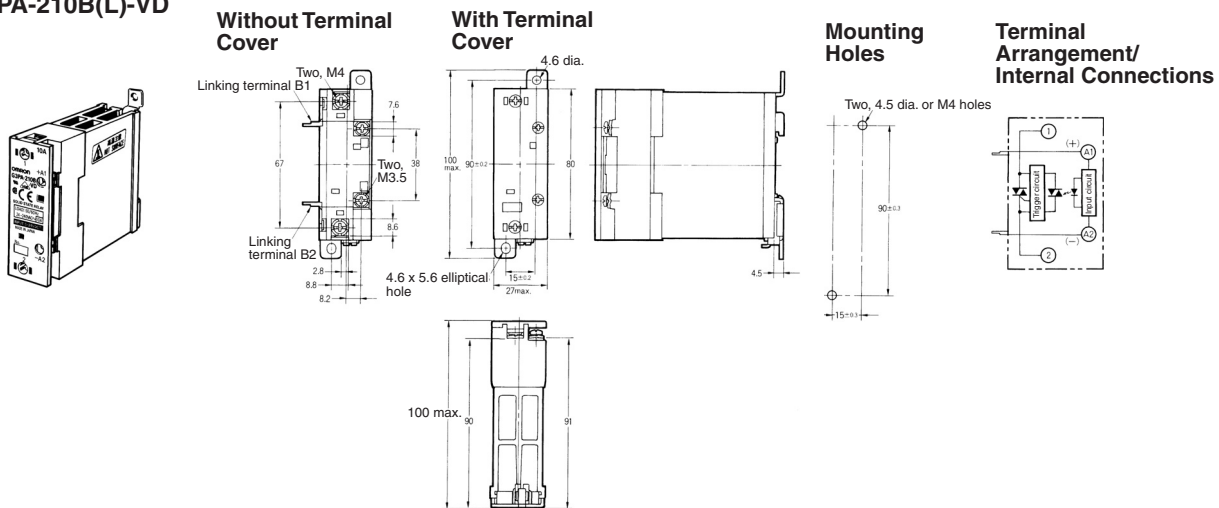

G3PA-220B(L)-VD

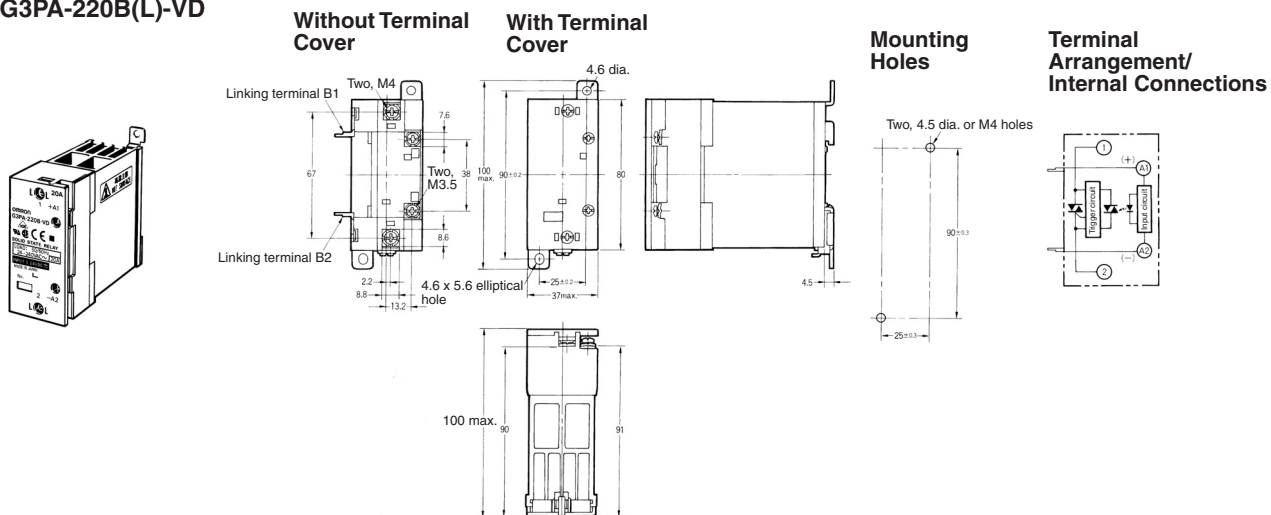

G3PA-240B(L)-VD

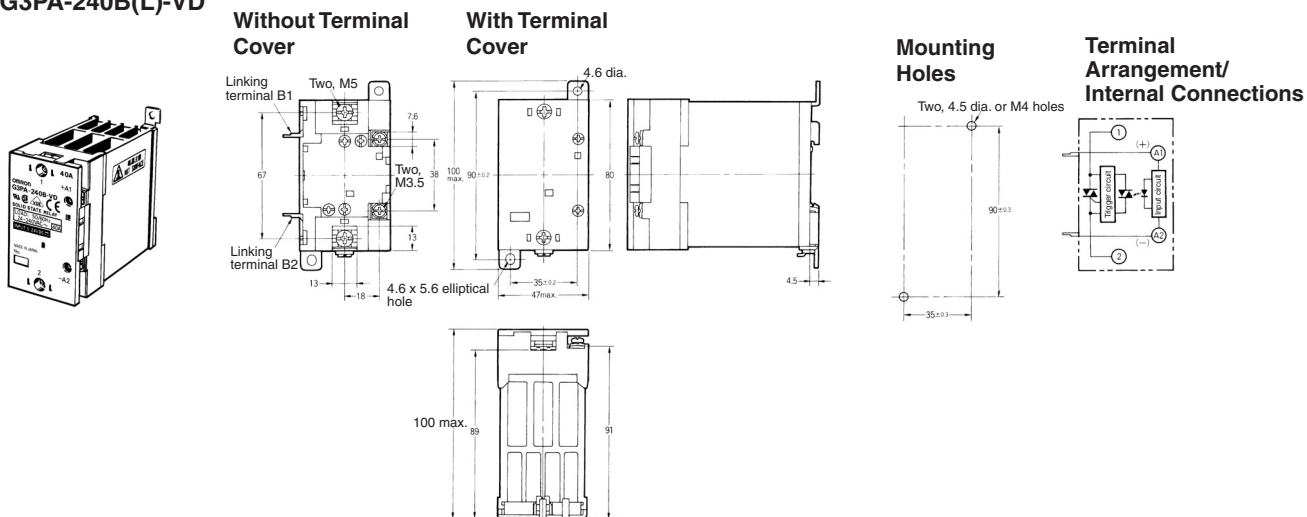

**G3PA-260B(L)-VD
G3PA-450B-VD-2**

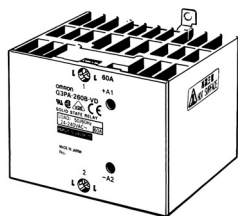

With Terminal Cover

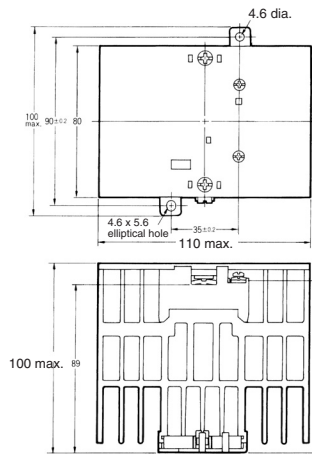

Without Terminal Cover

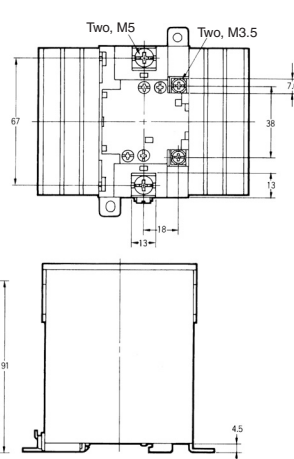

Mounting Holes

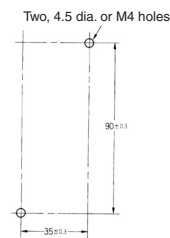

**Terminal Arrangement/
Internal Connections**

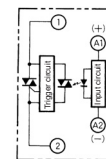

G3PA-420B-VD, G3PA-420B-VD-2

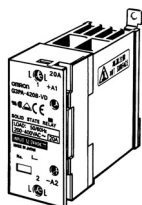

Without Terminal Cover

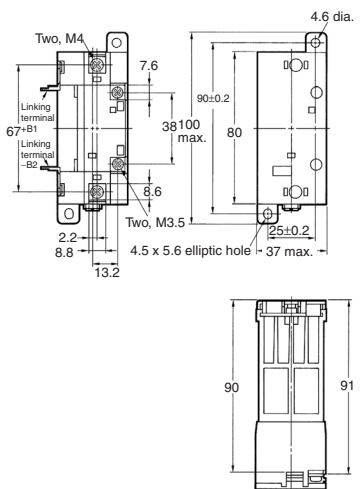

With Terminal Cover

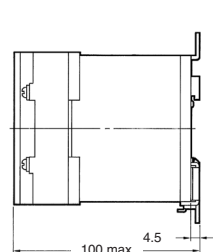

Mounting Holes

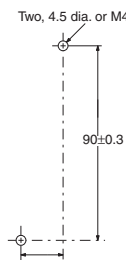

**Terminal Arrangement/
Internal Connections**

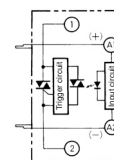

G3PA-430B-VD, G3PA-430B-VD-2

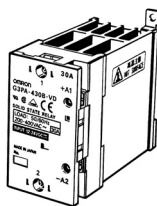

Without Terminal Cover

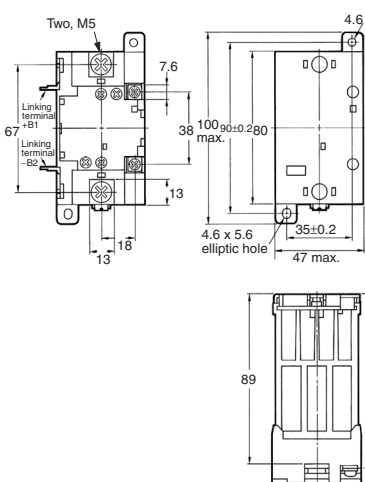

With Terminal Cover

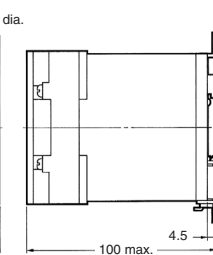

Mounting Holes

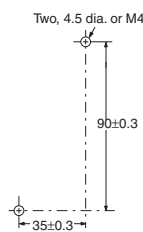

**Terminal Arrangement/
Internal Connections**

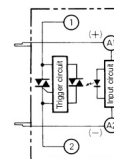

Safety Precautions

■ Precautions for Correct Use

Please observe the following precautions to prevent failure to operate, malfunction, or undesirable effect on product performance.

Load Connection

For an AC load, use a power supply rated at 50 or 60 Hz. The maximum operating frequency is 10 Hz. The G3PA-(VD) has a built-in varistor for overvoltage protection.

At a low applied voltage, such as 24 VAC, the load current is not fully supplied. When the Unit is switched ON, the voltage required to power the Unit deprives the output signal of the necessary voltage level and thus creates loss time. The lower the load voltage is, the greater the loss time is. This condition, however, will not create any serious problems.

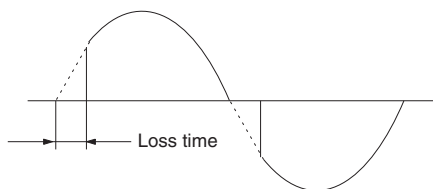

For a DC or L load, a diode should be connected in parallel the load to absorb the counter electromotive force of the load.

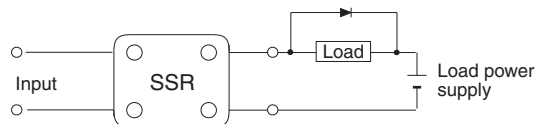

Noise Terminal Voltage according to EN55011

The G3PA-(VD) complies with EN55011 standards when a capacitor is connected to the load power supply as shown in the following circuit diagram.

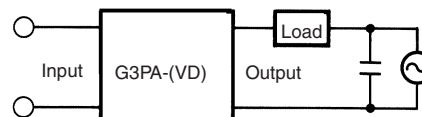

Recommended Capacitor: 1 μ F, 250 VAC

Mounting

When attaching a heat sink to the G3PA-(VD), in order to facilitate heat dissipation, apply silicone grease or equivalent heat-conductive grease on the heat sink. (Toshiba Silicone, Shinetsu Silicone, etc.)

Tighten the mounting screws of the heat sink with a torque of 0.78 to 0.98 N•m.

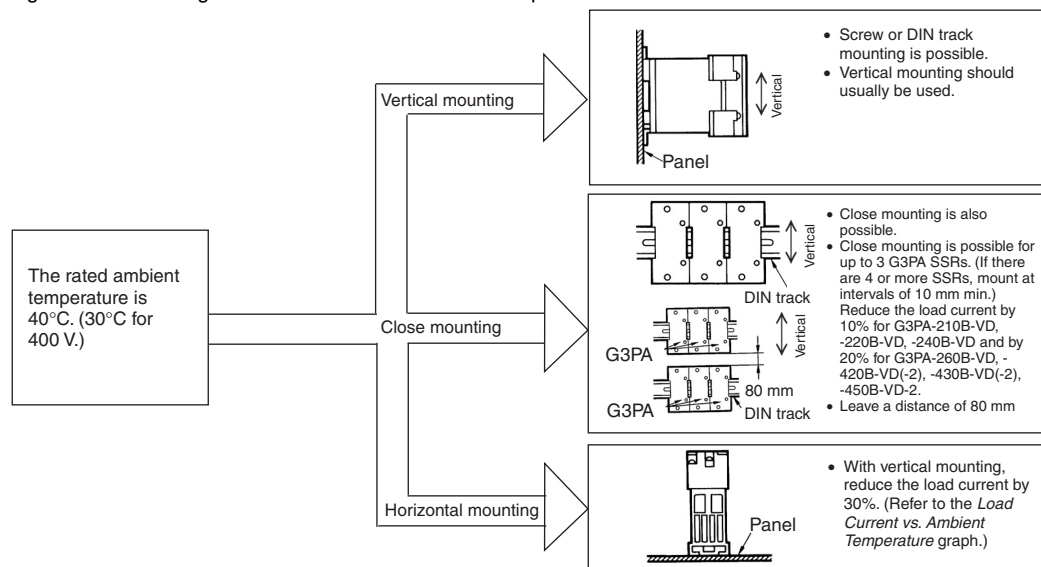

Note: Leave a distance of 60 mm min. between SSRs and ducts (especially above the SSR).

Close Mounting SSR Mounting Pitch

Panel Mounting

(At a rated ambient temperature of 40°C).

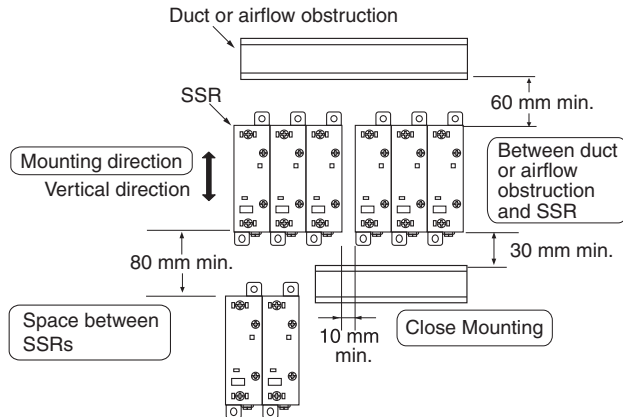

An SSR uses a semiconductor in the output element. This causes the temperature inside the control panel to increase due to heating resulting from the passage of electrical current through the load. To restrict heating, attach a fan to the ventilation outlet or air inlet of the control panel. This will reduce the ambient temperature of the SSRs and thus increase reliability. (Generally, each 10°C reduction in temperature will double the expected life.)

| Load current (A) | 10 A | 20 A | 30 A | 40 A | 60 A |
|---------------------------------|------|------|------|------|------|
| Required number of fans per SSR | 0.16 | 0.31 | 0.47 | 0.62 | 0.93 |

Example: For 10 SSRs with load currents of 20 A,

$$0.31 \times 10 = 3.1$$

Thus, 4 fans would be required.

Size of fans: 92 mm², Air volume: 0.7 m³/min,

Ambient temperature of control panel: 30°C

If there are instruments that generate heat in the control panel other than SSRs, additional ventilation will be required.

Relationship between SSRs and Ducts

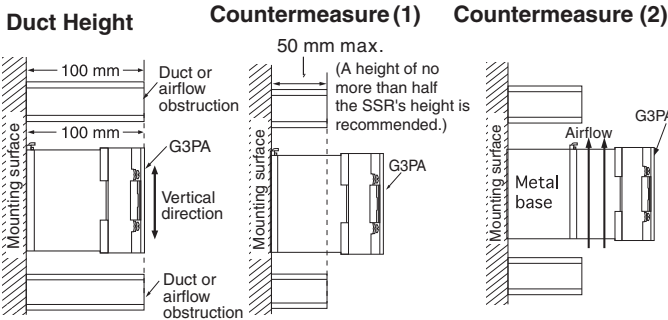

Do not surround the SSR with ducts, otherwise the heat radiation of the SSR will be adversely affected.

Use short ducts.

If the ducts cannot be shortened, place the SSR on a metal base so that it is not surrounded by the ducts.

Ventilation

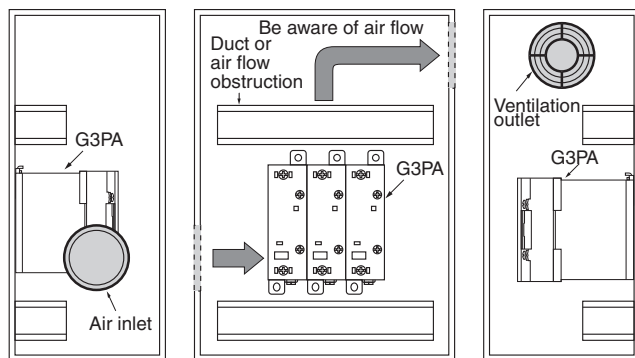

If the air inlet or air outlet has a filter, clean the filter regularly to prevent it from clogging and ensure an efficient flow of air.

Do not locate any objects around the air inlet or air outlet, otherwise the objects may obstruct the proper ventilation of the control panel.

A heat exchanger, if used, should be located in front of the SSR Units to ensure the efficiency of the heat exchanger.

Please reduce the ambient temperature of SSRs.

The rated load current of an SSR is measured at an ambient temperature of 25 or 40°C.



All sales are subject to Omron Electronic Components LLC standard terms and conditions of sale, which can be found at http://www.components.omron.com/components/web/webfiles.nsf/sales_terms.html

ALL DIMENSIONS SHOWN ARE IN MILLIMETERS.

To convert millimeters into inches, multiply by 0.03937. To convert grams into ounces, multiply by 0.03527.

OMRON[®]

**OMRON ELECTRONIC
COMPONENTS LLC**

55 E. Commerce Drive, Suite B
Schaumburg, IL 60173

847-882-2288

OMRON ON-LINE

Global - <http://www.omron.com>

USA - <http://www.components.omron.com>

Cat. No. X301-E-1b

09/11

Specifications subject to change without notice

Printed in USA